

Automation systems Drive solutions

Controls

Inverters



Motors

Gearboxes

Engineering Tools

Contents of the L-force catalogue

About Lenze		Lenze makes many things easy for you. A matter of principle: the right products for every application. L-force product portfolio			
Automation systems		Controller-based Automation	1.1		
		Drive-based automation	1.2		
Drive solutions		HighLine tasks	2.1		
		StateLine tasks	2.2		
		BaseLine tasks	2.3		
Controls	Cabinet Controllers	Controller 3200 C	3.1		
		Controller c300	3.2		
	Panel Controllers	Controller p500	3.3		
		Controller p300	3.4		
		I/O System 1000	3.5		
		Monitor Panel	3.6		
Inverters	Decentralised	Inverter Drives 8400 protec	4.1		
		Inverter Drives 8400 motec	4.2		
	Cabinet	Servo Drives 9400 HighLine	4.4		
		Inverter Drives 8400 TopLine	4.5		
		Servo-Inverter i700	4.6		
		Inverter Drives 8400 HighLine	4.7		
		Inverter Drives 8400 StateLine	4.8		
		Inverter Drives 8400 BaseLine	4.10		
		Motors	Servo motors	MCS synchronous servo motors	5.1
				MD□KS synchronous servo motors	5.2
MQA asynchronous servo motors	5.3				
MCA asynchronous servo motors	5.4				
Three-phase AC motors	MF three-phase AC motors		5.5		
	MH three-phase AC motors		5.6		
	MD three-phase AC motors		5.7		
	Lenze Smart Motor m300		5.8		
	MD/MH Basic three-phase AC motors		5.9		
	Gearboxes		Axial gearboxes	g700-P planetary gearbox	6.1
MPR/MPG planetary gearboxes		6.2			
g500-H helical gearbox		6.3			
GST helical gearboxes		6.4			
g500-S shaft-mounted helical gearbox		6.5			
GFL shaft-mounted helical gearboxes		6.6			
Right-angle gearboxes		g500-B bevel gearbox	6.7		
		GKR bevel gearboxes	6.8		
		GKS helical-bevel gearboxes	6.9		
		GSS helical-worm gearboxes	6.10		
Motor data		Assignment see above	6.11		
Engineering Tools			Navigator	7.1	
			Drive Solution Designer	7.2	
			Drive Solution Catalogue	7.3	
		Engineer	7.4		
		PLC Designer	7.5		
		VisiWinNET®	7.6		
		EASY Starter	7.7		

 Selected portfolio
 Additional portfolio

Lenze makes many things easy for you.

With our motivated and committed approach, we work together with you to create the best possible solution and set your ideas in motion - whether you are looking to optimise an existing machine or develop a new one. We always strive to make things easy and seek perfection therein. This is anchored in our thinking, in our services and in every detail of our products. It's as easy as that!

1

Developing ideas

Are you looking to build the best machine possible and already have some initial ideas? Then get these down on paper together with us, starting with small innovative details and stretching all the way to completely new machines. Working together, we will develop an intelligent and sustainable concept that is perfectly aligned with your specific requirements.

2

Drafting concepts

We see welcome challenges in your machine tasks, supporting you with our comprehensive expertise and providing valuable impetus for your innovations. We take a holistic view of the individual motion and control functions here and draw up consistent, end-to-end drive and automation solutions for you - keeping everything as easy as possible and as extensive as necessary.

3

Implementing solutions

Our easy formula for satisfied customers is to establish an active partnership with fast decision making processes and an individually tailored offer. We have been using this principle to meet the ever more specialised customer requirements in the field of machine engineering for many years.

4

Manufacturing machines

Functional diversity in perfect harmony: as one of the few full-range providers in the market, we can provide you with precisely those products that you actually need for any machine task – no more and no less. Our L-force product portfolio, a consistent platform for implementing drive and automation tasks, is invaluable in this regard.

5

Ensuring productivity

Productivity, reliability and new performance peaks on a daily basis – these are our key success factors for your machine. After delivery, we offer you cleverly devised service concepts to ensure continued safe operation. The primary focus here is on technical support, based on the excellent application expertise of our highly-skilled and knowledgeable after-sales team.

A matter of principle: the right products for every application.

Lenze's extensive L-force product portfolio follows a very simple principle. The functions of our finely scaled products are assigned to the three lines Base-Line, State-Line or High-Line.

But what does this mean for you? It allows you to quickly recognise which products represent the best solution for your own specific requirements.

Powerful products with a major impact:

- Easy handling
- High quality and durability
- Reliable technologies in tune with the latest developments

Lenze products undergo the most stringent testing in our own laboratory. This allows us to ensure that you will receive consistently high quality and a long service life. In addition to this, five logistics centres ensure that the Lenze products you select are available for quick delivery anywhere across the globe. It's as easy as that!

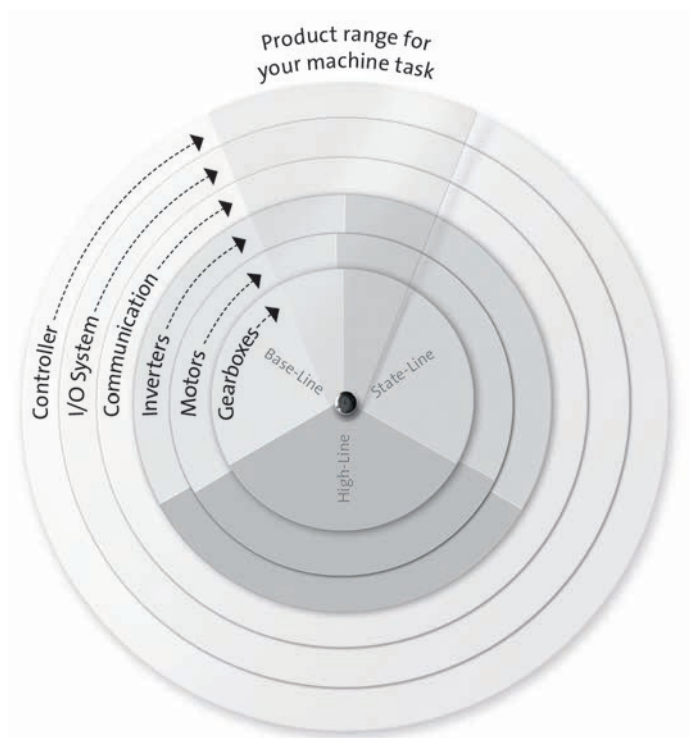

L-force product portfolio

Controls

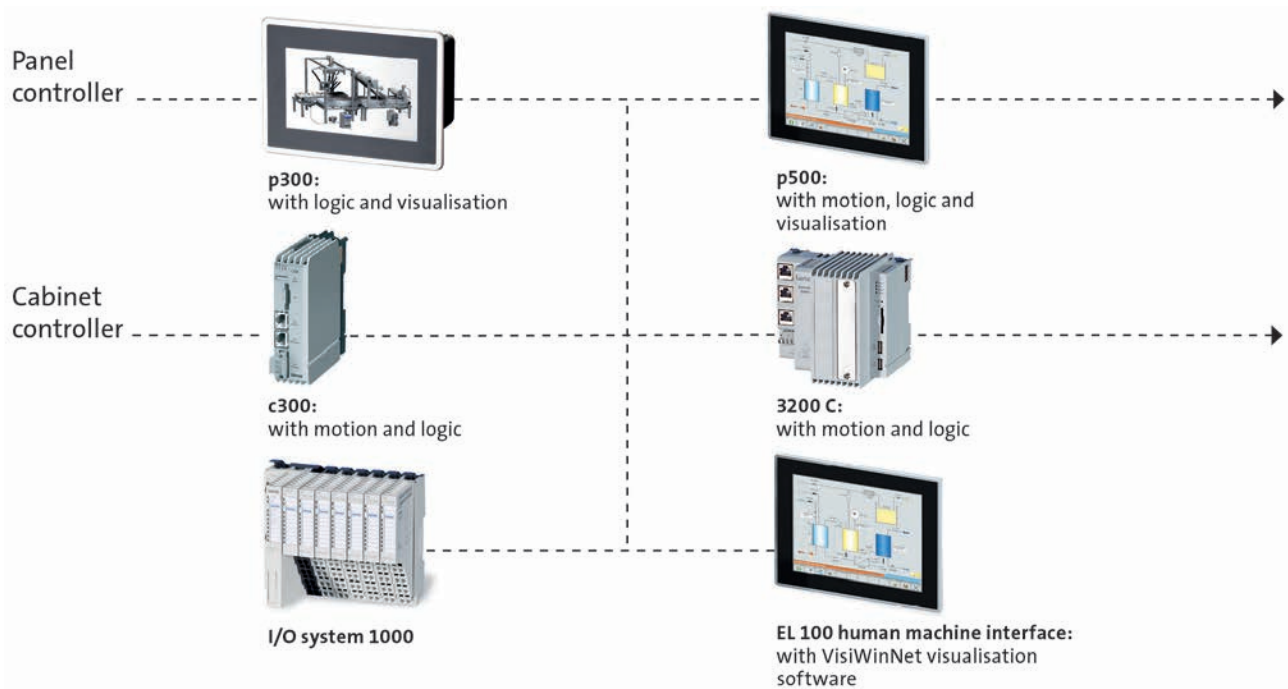

Engineering Tools

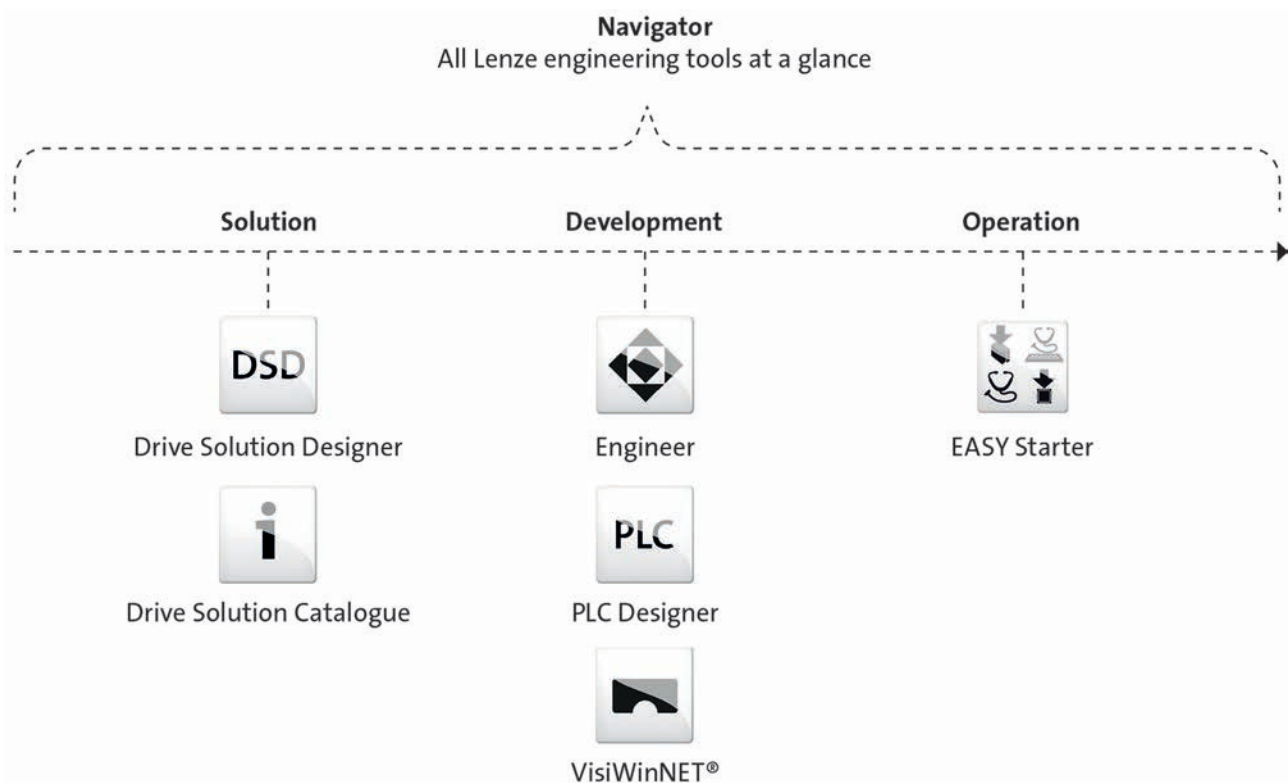

L-force product portfolio

Inverters

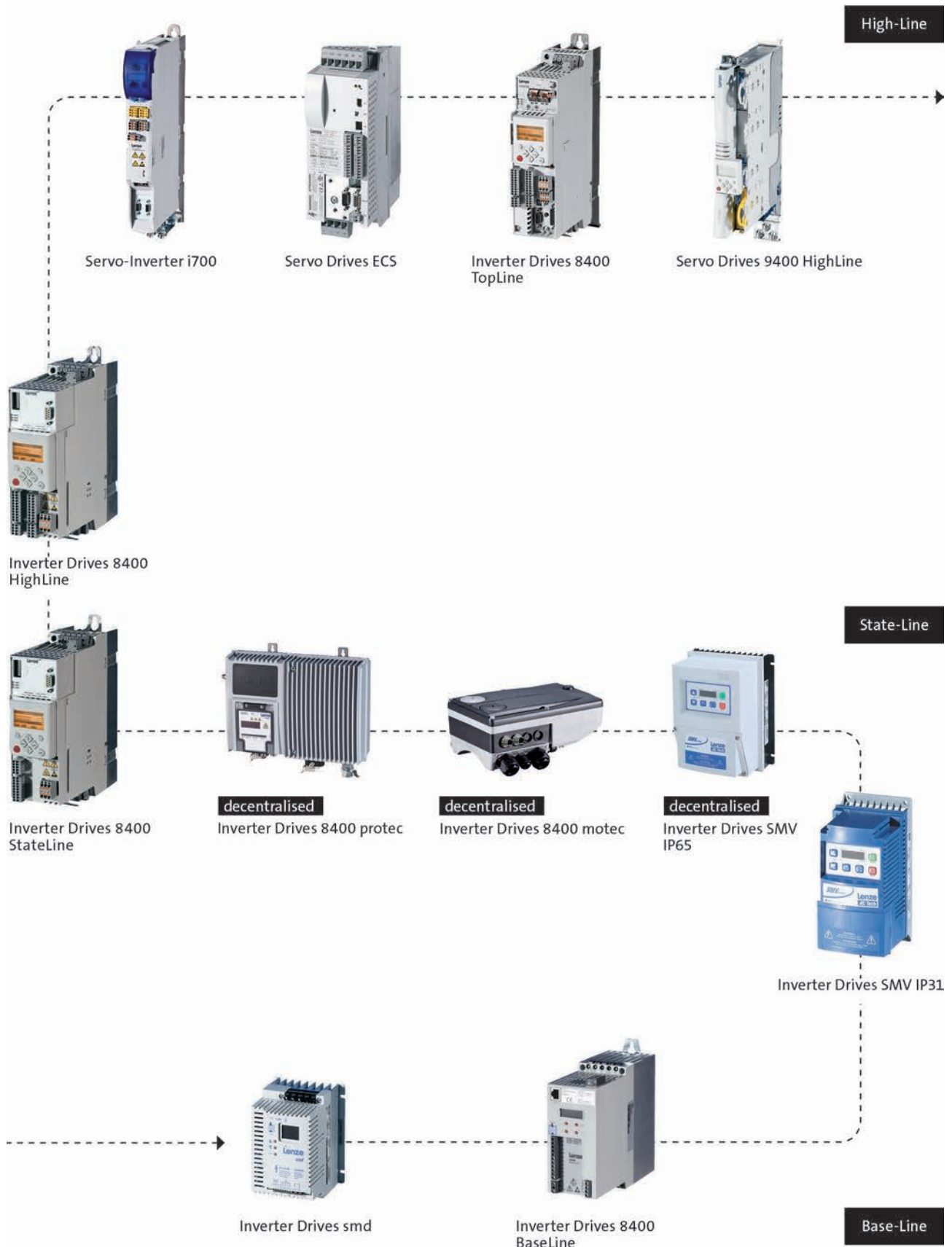

L-force product portfolio

Motors



L-force product portfolio

Gearboxes

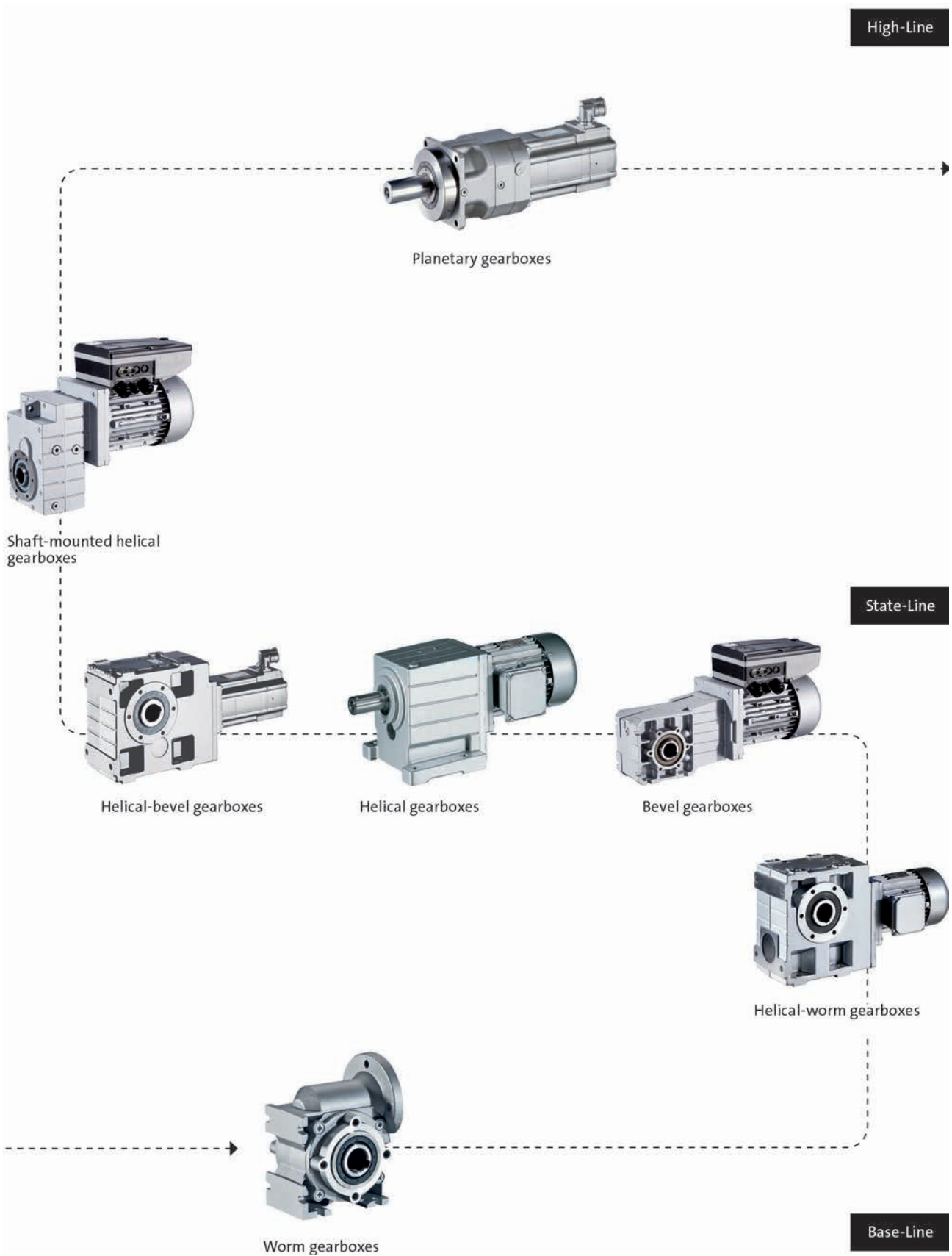

Inverters

Inverter Drives 8400 protec

0.75 to 7.5 kW



Inverter Drives 8400 protec



Contents

General information	Product key	4.1 - 4
	Equipment	4.1 - 5
	List of abbreviations	4.1 - 6
	8400 protec	4.1 - 7
	Functions and features	4.1 - 8
	Operating modes	4.1 - 9
Technical data	Standards and operating conditions	4.1 - 11
	Rated data 400 V	4.1 - 12
	Mains connection	4.1 - 16
	Motor connection	4.1 - 16
	Connection diagrams	4.1 - 17
	Control connections	4.1 - 18
Modules	Memory module	4.1 - 21
	Safety system (STO)	4.1 - 21
	Communication modules	4.1 - 21
	Communication module: CANopen	4.1 - 22
	EtherNet/IP communication module	4.1 - 23
	PROFIBUS communication module	4.1 - 24
PROFINET communication module	4.1 - 25	
Accessories	Brake resistors	4.1 - 27
	USB diagnostic adapter	4.1 - 28
	Diagnosis terminal	4.1 - 29
	Switch/potentiometer unit	4.1 - 29
	System cables	4.1 - 30

Inverter Drives 8400 protec

General information



Product key

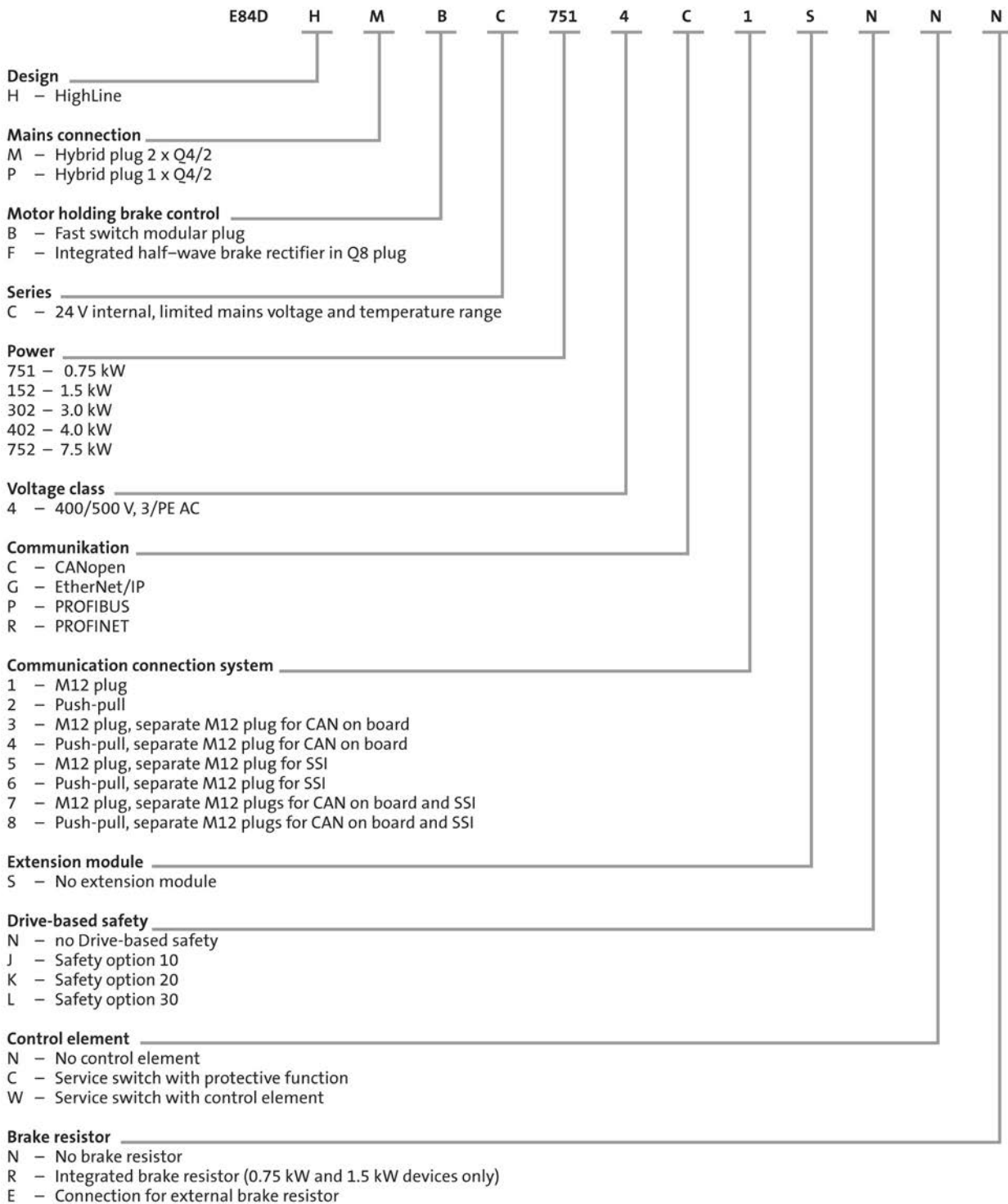

4.1

Inverter Drives 8400 protec

General information



Equipment

Display and diagnostics

Status LEDs
L-force diagnostic interface

Safety system

optional

Mains connection

Pluggable in loop-through technique

Pluggable control connections

For communication purposes and inputs/outputs



Brake resistor

Plug connection

Motor connection

Connection via hybrid cable

4.1

Inverter Drives 8400 protec

General information



List of abbreviations

b	[mm]	Dimensions
C _{th}	[KW _s]	Thermal capacity
f _{ch}	[kHz]	Rated switching frequency
h	[mm]	Dimensions
I _{N, out}	[A]	Rated output current
I _{N, AC}	[A]	Rated mains current
m	[kg]	Mass
n _{max}	[r/min]	Max. speed
P	[kW]	Typical motor power
P _V	[kW]	Power loss
P _N	[kW]	Rated power
R _N	[Ω]	Rated resistance
t	[mm]	Dimensions
U _{AC}	[V]	Mains voltage
U _{DC}	[V]	DC supply
U _{N, AC}	[V]	Rated voltage
U _{out}	[V]	Max. output voltage

ASM	Asynchronous motor
DIAG	Slot for diagnostic adapter
DIN	Deutsches Institut für Normung e.V.
EN	European standard
EN 60529	Degrees of protection provided by enclosures (IP code)
EN 60721-3	Classification of environmental conditions; Part 3: Classes of environmental parameters and their limit values
EN 61800-3	Electrical variable speed drives Part 3: EMC requirements including special test methods
IEC	International Electrotechnical Commission
IEC 61508	Functional safety of electrical/electronic/programmable electronic safety-related systems
IM	International Mounting Code
IP	International Protection Code
MCI	Slot for communication module (module communication interface)
NEMA	National Electrical Manufacturers Association
UL	Underwriters Laboratory Listed Product
UR	Underwriters Laboratory Recognized Product
VDE	Verband deutscher Elektrotechniker (Association of German Electrical Engineers)

Inverter Drives 8400 protec

General information



8400 protec

The wall-mounted device with a high degree of integration for complex decentralised systems. It excels through its robust design, high degree of operational reliability and fast installation.

This inverter with a high level of functionality facilitates both basic and servo-based applications. The Inverter Drives 8400 protec is supplied with all modules and interfaces ready to be connected.

On-site diagnostics

- A large display provide constant information on the operating status of the device.
- The clearly laid out LEDs provide additional diagnostics information. The fast diagnostics system thereby makes an effective contribution to increasing system availability.

Decentralised integrated positioning

- Implementing affordable and decentralised positioning applications with asynchronous motors. Whether switch-off, tabular or absolute positioning: the Inverter Drives 8400 protec offers integrated solutions for these applications. The ability to connect incremental and absolute value encoders rounds off this scope of functions.
- The parameters are set conveniently using the "L-force Engineer" here. The range also has a freely editable function block interconnection for integration of logic, arithmetic and mathematic program through graphic programming.

Safety engineering in line with EN ISO 13849-1

- The certified safety system enables not only the connection of local safety elements and safe communication via PROFIsafe, but also a series of safety functions.
- Safe torque off (STO)
- Safe stop 1 (SS1)
- Emergency stop (SSE)
- Safe operation mode selector (OMS)
- Safe enable switch (ES)

Further benefits

- 200% overload current (3s)
- V/f control with and without encoder
- Sensorless vector control
- Servo control
- Short-circuit and earth-fault protected
- DC-injection braking
- S-shaped ramp for smooth acceleration
- Max. output frequency 1,000 Hz
- 15 fixed frequencies
- Standardised connectors
- CANopen, EtherNet/IP, PROFIBUS, PROFINET

4.1



Inverter Drives 8400 protec

Inverter Drives 8400 protec

General information



Functions and features

Mode	8400 protec
Control types, motor control	
Sensorless vector control (SLVC)	For three-phase asynchronous motors
V/f control (VFCplus)	For three-phase AC motors and asynchronous servo motor (linear or square-law)
Basic functions	<ul style="list-style-type: none"> Freely assignable user menu Free function block interconnection with extensive function library Parameter change-over DC brake function Flying restart circuit S-shaped ramps for smooth acceleration PID controller 15 fixed frequencies Masking frequencies
Technology applications	<ul style="list-style-type: none"> Speed actuating drive Switch-off positioning without feedback Table positioning without feedback
Monitoring and protective measures	<ul style="list-style-type: none"> Short circuit Earth fault Overvoltage Motor phase failure Overcurrent I² x t-Motor monitoring Motor overtemperature Mains phase failure Protection for cyclical mains switching Motor stalling
Diagnostics	Data logger, logbook, oscilloscope functions
Status display	18 LEDs
Diagnostic interface	Integrated For USB diagnostic adapter or keypad (diagnosis terminal)
Braking operation	
Brake chopper	Integrated
Brake resistor ¹⁾	Internal or external

¹⁾ Internally only for 0.75 and 1.5 kW

Inverter Drives 8400 protec



General information

Operating modes

An inverter enables energy-efficient operation of a system in virtually all application cases. The various operating modes, which can be created by making just a few simple settings, facilitate this. The following characteristics and corresponding specifications listed on the following pages can be used to calculate the optimum operating mode during the project planning phase.

Standard setting

In its initial state when delivered, the inverter is set up for basic operation with a three-phase AC motor with V/f control. When operated in this mode, the rated torque of the motor is available in a setting range up to 50 Hz.

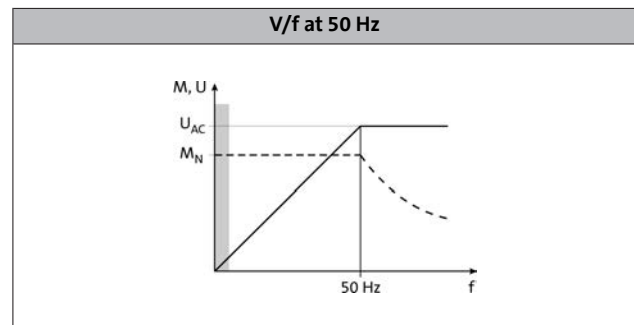

Extended setting range up to 87 Hz

If the V/f switchover point on the inverter is set to 87 Hz, the rated torque can be used across an extended setting range. Here, a 230/400V motor is for example used and operated in a delta layout with a 400V inverter. The setting range is then increased by 40 %. The inverter must be dimensioned for a rated motor current of 230 V.

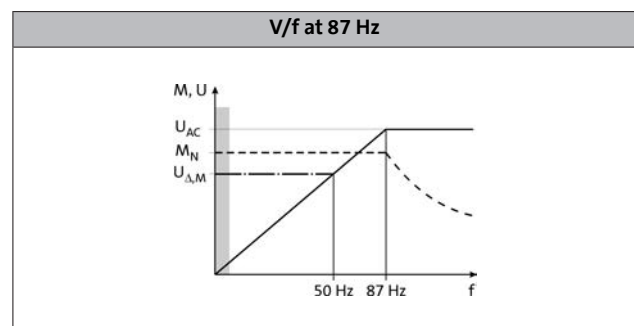

Operation with inverter-optimised MF motors

Large setting ranges and optimum operation at the rated torque: these are the strengths of the MF motor when used in combination with an inverter. The motors are optimised for a setting range up to 120 Hz. Compared to conventional 50Hz operation, the setting range increases by 250 %. It is quite simply not possible for a drive to be operated any more efficiently in a machine.

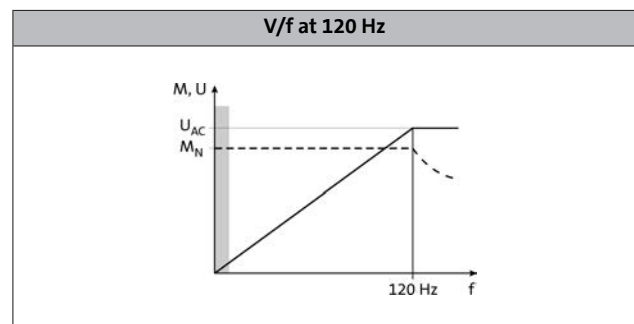

Operation with low loads

This operating mode can be used for various applications, e.g. for fans and pumps:

In fan and pump applications, the load behaviour follows a square-law characteristic depending on the speed. Often, an overload capacity of 120% is sufficient. This serves to operate the inverter during operation with increased power, i.e. the inverter can be dimensioned one power size smaller. The square-law characteristic which corresponds to the load behaviour can be set in the inverter.

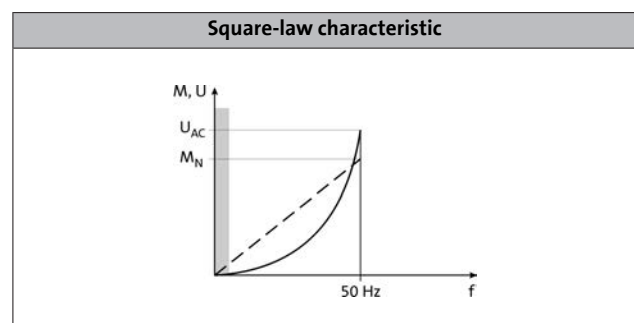

Inverter Drives 8400 protec

General information



Operating modes

VFC-eco energy saving mode

The Inverter Drives 8400 make energy saving especially easy with the "VFC eco" function. Particularly in the partial load operational range, this function significantly reduces energy requirements. Combined with the new L-force MF three-phase AC motors, this drive solution impresses with the maximum energy efficiency of a Lenze BlueGreen solution.

The "VFC eco" mode adjusts the magnetising current of a motor intelligently to actual requirements. This is particularly useful in partial load operational range, as this is precisely where three-phase AC motors need to be supplied with a greater magnetising current than the operating conditions actually require. The "VFC eco" mode allows losses to be reduced so much that savings of up to 30% can be achieved.

Energy efficiency can then be increased even further with the MF three-phase AC motors. These motors have been specifically designed for operation with frequency inverters. They operate at 120 Hz instead of 50 Hz, as 4-pole three-phase AC motors are at their most efficient at this frequency.

Overcurrent operation

The inverters can be driven at higher amperages beyond the rated current if the duration of this overcurrent operation is time limited. Two utilisation cycles with a duration of 15 s and 180 s are defined. Within these utilisation cycles, an overcurrent is possible for a certain time if afterwards an accordingly long recovery phase takes place. For both utilisation cycles, a moving average is determined separately. The adjacent diagram shows both cycles: 15 s in red and 180 s in blue. The overload times t_{o1} are 3 s (T_1) and 60 s (T_3) respectively, the corresponding recovery times t_{re} are 12 s (T_2) and 120 s (T_4) respectively. The following tables show the resulting maximum output currents. Monitoring of the device utilisation ($I \times t$) activates the set error response (trip or warning if one of the two utilisation values exceeds the limit of 100 %).

Switching frequencies

On an inverter, the term "switching frequency" is understood to mean the frequency with which the input and outputs of the output module (inverter) are switched. On an inverter, the switching frequency can generally be set to values between 2 and 16 kHz, whereby the selection is based on the respective power output.

Since losses (in the form of heat) can be generated when switching the modules, the inverter can provide a higher output current at a switching frequency of 2 kHz. In addition to this, it is also important to differentiate between operation at a fixed switching frequency and a variable switching frequency, whereby the switching frequency is automatically reduced based on the output current here.

The data for operation at increased output is permitted for operation at a switching frequency of 2 or 4 kHz and in an ambient temperature of max. 40 °C.

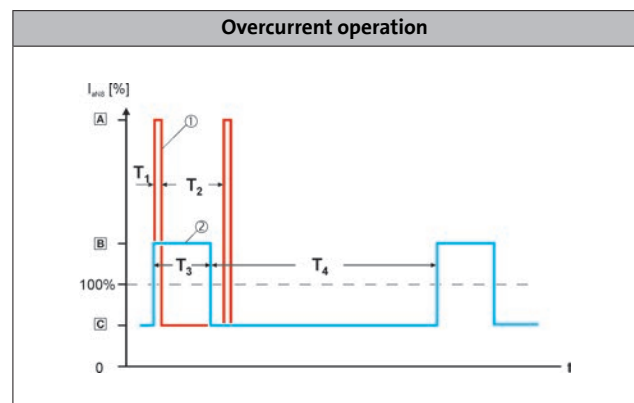
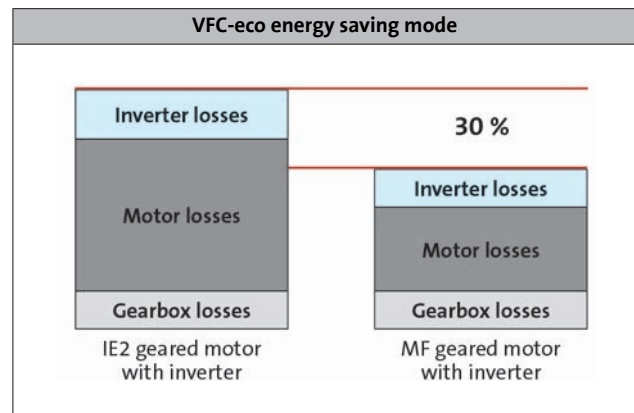

Inverter Drives 8400 protec

Technical data



Standards and operating conditions

Mode			
Product			8400 protec
Conformity			
CE			Low-Voltage Directive 2006/95/EG
Approval			
UL 508C			Power Conversion Equipment (file no. E132659)
CSA			CSA 22.2 No. 14
Certification			
Degree of protection			
EN 60529			IP65 mit Bedienelement "C" IP64
NEMA 250			
Climatic conditions			
Storage (EN 60721-3-1)			1K3 (temperature: -25 °C ... +60 °C)
Transport (EN 60721-3-2)			2K3 (temperature: -25 °C ... +75 °C)
Operation (EN 60721-3-3)			3K3 (temperature: -25 °C ... +55 °C)
Current derating at over 40°C			2.5 % / K
Site altitude			
Amsl	H _{max}	[m]	4000
Current derating at over 1000 m		[%/1000 m]	5
Vibration resistance			
Transport (EN 60721-3-2)			2M2
Operation (EN 60721-3-3)			3M4
Operation (Germanischer Lloyd)			General conditions: acceleration resistant up to 2 g

4.1

Mode			
Product			8400 protec
Supply form			
			Systems with earthed star point (TN and TT systems)
Noise emission			
EN 61800-3			Integrated RFI suppression: cable-guided, category C2 up to 20 m shielded motor cable
Insulation resistance			
EN 61800-5-1			≤ 2000 m amsl overvoltage category III > 2000 m amsl overvoltage category II
Degree of pollution			
EN 61800-5-1			2
Protective insulation of control circuits			
EN 61800-5-1			Safe mains isolation: double/reinforced insulation

Inverter Drives 8400 protec

Technical data



Rated data 400 V

- The data is valid for operation at 400 V AC.
- Unless otherwise specified, the data refers to the default setting.

				
Typical motor power				
4-pole asynchronous motor	P	[kW]	0.75	1.50
Product key				
Inverter			E84D□□□7514□□□□	E84D□□□1524□□□□
Mains voltage range				
	U_{AC}	[V]	3/PE AC 320 V-0% ... 440 V+0%, 45 Hz-0 % ... 65 Hz+0%	
Rated mains current				
	$I_{N, AC}$	[A]	4.1	5.5
Rated output current				
	$I_{N, out}$	[A]	2.4	3.9
Rated switching frequency				
	f_{ch}	[kHz]	8	
Output current				
2 kHz	I_{out}	[A]	2.4	3.9
4 kHz	I_{out}	[A]	2.4	3.9
8 kHz	I_{out}	[A]	2.4	3.9
16 kHz	I_{out}	[A]	1.6	2.3

Data for 60 s overload

Max. output current				
	$I_{max, out}$	[A]	3.6	5.9
Overload time				
	t_{ol}	[s]	60.0	
Recovery time				
	t_{re}	[s]	120.0	

Data for 3 s overload

Max. short-time output current				
	$I_{max, out}$	[A]	4.8	7.8
Overload time				
	t_{ol}	[s]	3.0	
Recovery time				
	t_{re}	[s]	75.0	

Inverter Drives 8400 protec

Technical data



Rated data 400 V

- The data is valid for operation at 400 V AC.
- Unless otherwise specified, the data refers to the default setting.

				
Typical motor power				
4-pole asynchronous motor	P	[kW]	0.75	1.50
Product key				
Inverter			E84D□□□7514□□□□	E84D□□□1524□□□□
Power loss				
	P _V	[kW]	0.066 ²⁾	0.084 ²⁾
Mass				
	m	[kg]	7.6	
Max. cable length				
Shielded motor cable	I _{max}	[m]	20	

4.1

Brake chopper rated data

Rated power, Brake chopper				
	P _N	[kW]	0.9	2.0
Max. output power, Brake chopper				
	P _{max, 1}	[kW]	3.5	
Min. brake resistance				
	R _{min}	[Ω]	150.0	

Dimensions

Dimensions				
Height	h	[mm]	260 ³⁾	
Width	b	[mm]	353	
Depth	t	[mm]	110	

¹⁾ Technically possible cable lengths, irrespective of EMC requirements

²⁾ Operation at rated output current I_{N, out}.

³⁾ + 30 mm with connector shell.

Inverter Drives 8400 protec

Technical data



Rated data 400 V

- The data is valid for operation at 400 V AC.
- Unless otherwise specified, the data refers to the default setting.

					
Typical motor power					
4-pole asynchronous motor	P	[kW]	3.00	4.00	7.50
Product key					
Inverter			E84D□□□3024□□S□	E84D□□□4024□□S□	E84D□□□7524□□S□
Mains voltage range					
	U_{AC}	[V]	3/PE AC 320 V-0% ... 440 V+0%, 45 Hz-0 % ... 65 Hz+0%		
Rated mains current					
	$I_{N, AC}$	[A]	9.7	12.9	20.8
Rated output current					
	$I_{N, out}$	[A]	7.3	9.5	16.0
Rated switching frequency					
	f_{ch}	[kHz]	8		
Output current					
2 kHz	I_{out}	[A]	7.3	9.5	16.0
4 kHz	I_{out}	[A]	7.3	9.5	16.0
8 kHz	I_{out}	[A]	7.3	9.5	16.0
16 kHz	I_{out}	[A]	4.9	6.3	10.7

Data for 60 s overload

Max. output current					
	$I_{max, out}$	[A]	11.0	14.3	19.0
Overload time					
	t_{ol}	[s]	60.0		
Recovery time					
	t_{re}	[s]	120.0		

Data for 3 s overload

Max. short-time output current					
	$I_{max, out}$	[A]	14.6	19.0	32.0
Overload time					
	t_{ol}	[s]	3.0		
Recovery time					
	t_{re}	[s]	75.0		

Inverter Drives 8400 protec

Technical data



Rated data 400 V

- The data is valid for operation at 400 V AC.
- Unless otherwise specified, the data refers to the default setting.

					
Typical motor power					
4-pole asynchronous motor	P	[kW]	3.00	4.00	7.50
Product key					
Inverter			E84D□□□3024□□S□	E84D□□□4024□□S□	E84D□□□7524□□S□
Power loss					
	P _V	[kW]	0.15 ²⁾		0.23
Mass					
	m	[kg]	11.3		
Max. cable length					
Shielded motor cable	I _{max}	[m]	50		

4.1

Brake chopper rated data

Rated power, Brake chopper					
	P _N	[kW]	3.9	5.2	
Max. output power, Brake chopper					
	P _{max, 1}	[kW]	11.2		
Min. brake resistance					
	R _{min}	[Ω]	47.0		

Dimensions

Dimensions					
Height	h	[mm]	260 ³⁾		
Width	b	[mm]	434		
Depth	t	[mm]	148		

¹⁾ Technically possible cable lengths, irrespective of EMC requirements

²⁾ Operation at rated output current I_{N, out}.

³⁾ + 30 mm with connector shell.

Inverter Drives 8400 protec

Technical data



Mains connection

- ▶ The mains fuse and cable cross-section specifications are for a mains connection of 3 x 400 V.
- ▶ Class gG/gI fuses or class gRL semiconductor fuses.
- ▶ The cable cross-sections apply to PVC-insulated copper cables.
- ▶ Use for installation with UL-approved cables, fuses and brackets.

Typical motor power	Mains voltage	Product key	Circuit breaker	Fuse		Mains connection
				EN 60204-1	UL	
4-pole asynchronous motor		Inverter		EN 60204-1	UL	Cross-section (without mains choke)
P	U_{AC}		I	I	I	q
[kW]	[V]		[A]	[A]	[A]	[mm ²]
0.75	3 AC 320 ... 440	E84D□□□7514□□S□	C16	16	15	2.5
1.50		E84D□□□1524□□S□				
3.00		E84D□□□3024□□S□				
4.00		E84D□□□4024□□S□	C20	20	20	4.0
7.50		E84D□□□7524□□S□				

4.1

Motor connection

- ▶ Keep motor cables as short as possible, as this has a positive effect on the drive behaviour.
- ▶ With group drives (multiple motors on one inverter), the resulting cable length is the key factor. This can be calculated using the hardware manual.
- ▶ Electric strength of the motor cable: 1 kV as per VDE 250-1.

Typical motor power	Mains voltage	Product key	Max. cable length	
			shielded C2 without external measures	shielded C2 with external measures
4-pole asynchronous motor		Inverter		
P	U_{AC}		l_{max}	l_{max}
[kW]	[V]		[m]	[m]
0.75	3 AC 320 ... 440	E84D□□□7514□□S□	20	20
1.50		E84D□□□1524□□S□		
3.00		E84D□□□3024□□S□		
4.00		E84D□□□4024□□S□		
7.50		E84D□□□7524□□S□		

Inverter Drives 8400 protec

Technical data



Connection diagrams

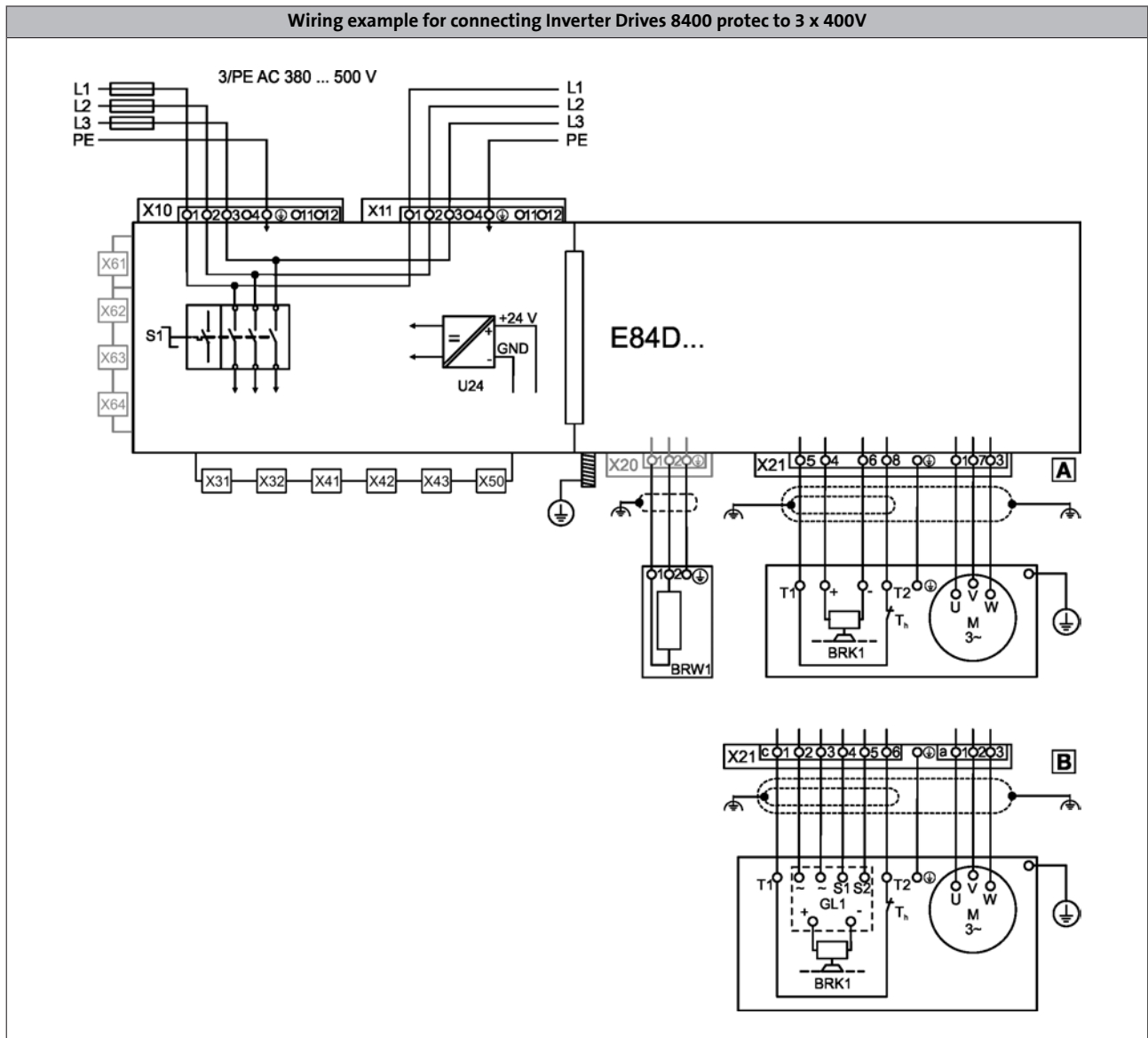

- [A] Motor connection system: connector type Q8/0
- [B] Motor connection system: modular connector type

4.1

Inverter Drives 8400 protec

Technical data



Control connections

Mode	
Product	8400 protec
Analog inputs	
Number	1 Optional: voltage or current input
Resolution	10 bits
Value range	0 ... 10V, 0/4 ... 20mA
Digital inputs	
Number	6 or 4 (configurable)
Switching level	PLC (IEC 61131-2)
Max. input current	11 mA
Function	
Digital outputs	
Number	0 or 2 (configurable)
Switching level	PLC (IEC 61131-2)
Max. output current	200 mA per output
Relay	
Number	
Contact	
AC connection	
DC connection	
External 24 V DC supply	
	To support communication when the 400 V is switched off
Internal 24 V DC supply	
	Max. 1 A for inputs/outputs and sensor feeds
Interfaces	
CANopen	on board optional
Extensions	Integrated fieldbus communication
Safety engineering	1-2 safe inputs for passive/active actuators/PROFIsafe/PROFIsafe, depending on the safety option selected
Drive interface	
Encoder input	Via 2 digital inputs, HTL, 2-track, 10 kHz 100 kHz, can also be used as a frequency input, SSI input (instead of analog input),

4.1

Inverter Drives 8400 protec

Technical data



Control connections

Connection of analog inputs and outputs

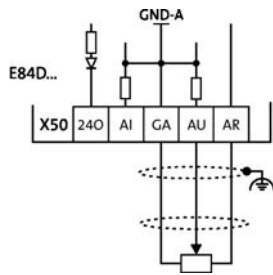

4.1

Connection of digital inputs and outputs

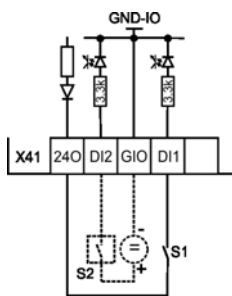

Connection of digital inputs and outputs

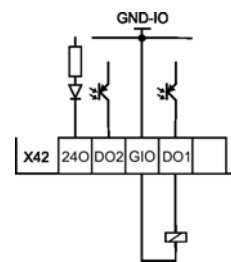

Inverter Drives 8400 protec

Technical data



Inverter Drives 8400 protec

Modules



Memory module

All drive settings for the 8400 are stored on the memory module, which is a pluggable memory chip. The memory module ensures that drives can be replaced quickly and without errors being made.

Mode	Features	Product key
Memory module	<ul style="list-style-type: none"> For 8400 StateLine, HighLine, Topline and protec Packaging unit: 5 items 	E84AYM10S/M

Safety engineering

The following safety functions are integrated into the communication modules depending on the device version:

Safety option 10

- Safe torque off (STO)
- The drive is safely disconnected when a request is sent via connected active or passive sensors

Safety option 20

- Safe torque off (STO)
- Safety stop 1 (SS1)
- Safe stop emergency (SSE)
- Safe operation mode selector (OMS)
- Safe enable switch (ES)
- The drive is safely disconnected by a higher-level safety PLC by means of PROFIsafe/PROFINET

Safety option 30

- Safe torque off (STO)
- Safe stop 1 (SS1)
- Safe stop emergency (SSE)
- Safe operation mode selector (OMS)
- Safe enable switch (ES)
- The drive is safely disconnected by a higher-level safety PLC by means of PROFIsafe/PROFINET and via connected active or passive sensors

4.1

Safety functions	10	20	30
Basic error limit (at 25 °C)			
Certification			
EN ISO 13849-1	Category 4 / PLe	Category 3 / PLe	
EN 61800-5-2		SIL 3	
EN 62061		SIL 3	
IEC 61508		SIL 3	
Fail-safe state	Safe torque off		

Communication modules

Inverter Drives 8400 protec are supplied with permanently installed communication modules. As well as containing the components for fieldbus communication, these modules also include the digital inputs and outputs. An analog input or a synchronous serial interface (SSI) can also be provided as an option.

Overview

Communication module	Digital inputs	Digital outputs	Analog inputs
	Number	Number	Number
CANopen	6 or 4 (configurable)	0 or 2 (configurable)	1 ¹⁾
EtherNet/IP	6 or 4 (configurable)	0 or 2 (configurable)	1 ¹⁾
PROFIBUS	6 or 4 (configurable)	0 or 2 (configurable)	1 ¹⁾
PROFINET	6 or 4 (configurable)	0 or 2 (configurable)	1 ¹⁾

¹⁾ Or as a synchronous serial interface (SSI).

Inverter Drives 8400 protec

Modules



Communication module: CANopen

The CANopen communication module allows the 8400 protec to be controlled via the "CANopen" bus system using digital control signals. It is integrated in the inverter with the product key E84D□□□□□□□□C.

The benefits of this system include:

- Easy, yet very powerful bus system
- Easy system integration, as a wide range of sensors and actuators is available in the market.

Mode	Features
Communication module	
CANopen	• Addressing via DIP switches or parameters

4.1

Technical data

Mode			
Communication module			CANopen
Communication			
Medium			DIN ISO 11898
Communication profile			CANopen, DS301 V4.02 Lenze system bus
Device profile			Lenze device control
Baud rate			
	b	[kBit/s]	20 50 125 250 500 800 1000
Node			
			Slave Multi-master
Network topology			
			Line with terminating resistors (120 ohm) at both ends
Number of logical process data channels			
			4 (each with 1 - 8 bytes)
Number of logic parameter data channels			
			5
Number of bus nodes			
			63
Max. cable length			
per bus segment	l_{max}	[m]	17 for 1000 kbps 40 for 800 kbps 110 for 500 kbps 290 for 250 kbps 630 for 125 kbps 1500 for 50 kbps 3900 for 20 kbps 8000 for 10 kbps



EtherNet/IP communication module

The EtherNet/IP communication module based on standard TCP and UDP enables the Inverter Drives 8400 motec to support a continuous communication from the field level right through to the controlling system. The product key E84D□□□□□□□□□□G

indicates an inverter with an integrated communication module

The benefits of this system include:

- Currently widespread fieldbus based on real-time Ethernet
- Supports DHCP and BootP in allocating the IP address
- Devices linked via EtherNet/IP can be implemented seamlessly and with minimum configuration expense via mapping into the I/O tree of the RSLogix programming tool

Mode	Features
Communication module	
EtherNet/IP	• Supports multicast messages, UCMM, ACD, BOOTP/DHCP, VLAN-Tagging/DSCP

Technical data

Mode				EtherNet/IP
Communication module				
Communication				
Medium				CAT5e S/FTP according to ISO/ICE11801 / EN50173
Communication profile				EtherNET/IP, AC Drive
Baud rate				
	b	[MBit/s]		10/100 (full duplex/half duplex)
Node				Slave (Adapter)
Network topology				Tree, star and line
Process data words (PZD)				
16 Bit				1 ... 16
Number of bus nodes				max. 254 im Subnetz
Max. cable length				
between two nodes	l_{max}	[m]		100

Inverter Drives 8400 protec

Modules



PROFIBUS communication modules

With the PROFIBUS communication module, the 8400 protec supports the most widespread current fieldbus system. It is integrated in the inverter with the product key E84D□□□□□□□□P.

The benefits of this system include:

- Widespread and very powerful fieldbus system
- Integrated I/O node. Capable of communication and reading inputs even when the 400V supply is switched off.

Mode	Features
Communication module	
PROFIBUS	<ul style="list-style-type: none"> • DPVO: basic functionalities such as cyclical data exchange and diagnostics • DPV1: supports acyclical data exchange for parameter setting, operation and alarm handling

4.1

Technical data

Mode			
Communication module			PROFIBUS
Communication			
Medium			RS 485
Communication profile			PROFIBUS-DP-V1 PROFIBUS-DP-V0
Device profile			PROFIDrive, version 3
Baud rate			
	b	[kBit/s]	9.6 ... 12 000 (automatic detection)
Node			
			Slave
Network topology			
			with repeater: line or tree without repeater: line
Process data words (PZD)			
16 Bit			1 ... 16
DP user data length			
			Optional parameter channel (4 words) + process data words
Number of bus nodes			
			31 slaves + 1 master per bus segment With repeaters: 125
Max. cable length			
per bus segment	l_{\max}	[m]	1200 (depending on the baud rate and the cable type used)

Inverter Drives 8400 protec

Modules



PROFINET communication modules

With the PROFINET communication module, the 8400 protec supports a fieldbus system for continuous communication from the field level right through to company management level. It is integrated in the inverter with the product key E84D□□□□□□□□R.

The benefits of this system include:

- Fieldbus system capable of handling large data volumes
- Use of IT standards
- Integrated switch allows direct looping of PROFINET via the inverters
- Integrated I/O node. Capable of communication and reading inputs even when the 400V supply is switched off.

Mode	Features
Communication module	
PROFINET	<ul style="list-style-type: none"> • Automatic detection of the 100 Mbps baud rate • Creation of a line topology through integrated 2-port switch • Support for I&M 0 to 4 functionality for identification of the standard device • Link / Activity

4.1

Technical data

Mode			
Communication module			PROFINET
Communication			
Medium			CAT5e S/FTP according to ISO/ICE11801 (2002)
Communication profile			PROFINET RT Conf. Class B
Baud rate			
	b	[MBit/s]	10/100
Node			
			Slave (Device)
Network topology			
			Tree, star and line
Number of logical process data channels			
			1 ring as client (media redundancy)
Process data words (PZD)			
16 Bit			1 ... 16
Max. cable length			
between two nodes	l_{max}	[m]	100

Inverter Drives 8400 protec

Modules



4.1

Inverter Drives 8400 protec

Accessories



Brake resistors

An external brake resistor is required to brake high moments of inertia or in the event of prolonged operation in generator mode; this resistor converts braking energy into heat.

The brake resistors recommended in the table below have been dimensioned for approx. 1.5 times the regenerative power, with a cycle time of 15/135 s (brake/rest ratio). These brake resistors generally meet the usual requirements of standard applications.

The brake resistors are fitted with a thermostat (potential-free NC contact).



Brake resistor

Typical motor power	Mains voltage	Product key		Rated resistance	Rated power	Thermal capacity	Dimensions	Mass
		Inverter	Brake resistor					
4-pole asynchronous motor								
P	U _{AC}			R _N	P _N	C _{th}	h x b x t	m
[kW]	[V]			[Ω]	[kW]	[KWs]	[mm]	[kg]
0.75	3 AC 320 ... 440	E84D□□□7514□□S□	ERBS240R300W	240.0	300.0	45.0	382 x 124 x 122	2.0
1.50		E84D□□□1524□□S□	ERBS180R350W	180.0	350.0	53.0		
3.00		E84D□□□3024□□S□	ERBS047R400W	47.0	400.0	60.0	400 x 110 x 105	2.3
4.00		E84D□□□4024□□S□						
7.50		E84D□□□7524□□S□						

Inverter Drives 8400 protec

Accessories



USB diagnostic adapter

The operation, parameter setting and diagnostics of the Inverter Drives 8400 and the Servo Drives 9400 via the L-force diagnostics is made with the keypad X400 or a PC. The connection of a PC can be made via a USB interface and the USB diagnostic adapter.

For connecting the USB diagnostic adapter with the L-force diagnostics interface (DIAG) at the inverter, three different connecting cables are separately available in the lengths 2.5 m, 5 m and 10 m. The connection can be established during operation. The engineering tools EASY Starter or Engineer can be used to carry out the operation, parameter setting or diagnostics of the inverters. Both tools have simple intuitive surfaces. This enables a quick and easy commissioning.

Optionally to the USB diagnostic adapter, the PC system bus adapter can be used. For this purpose, a CANopen interface must be available at the inverter.



USB diagnostic adapter incl. connecting cable to the PC

- The engineering tools EASY Starter or Engineer are used for operation, parameter setting and diagnostics of the inverters.

Mode		Features	Product key
USB diagnostic adapter		<ul style="list-style-type: none"> • Input-side voltage supply via USB connection on PC • Output-side voltage supply via inverter's diagnostic interface • Diagnostic LEDs • Electrical isolation of PC and inverter • Hot-pluggable 	E94AZCUS

Connecting cables for USB diagnostic adapter

Mode	Features	Product key
Connecting cable for USB diagnostic adapter	• Length: 2.5 m	EWL0070
	• Length: 5 m	EWL0071
	• Length: 10 m	EWL0072

Inverter Drives 8400 protec

Accessories



Diagnosis terminal

The diagnosis terminal can be used as an alternative to a PC if you are looking for an easy way to operate the inverter, set parameters or carry out diagnostics locally. The structured menus and plain text display provide quick access to data.

The diagnosis terminal can be plugged into the inverter's L-force diagnostic interface (DIAG) from the outside.



Diagnosis terminal

Mode	Features	Slot	Product key
Diagnosis terminal	<ul style="list-style-type: none">• Diagnosis terminal inside robust housing• incl. 2.5 m cable• Degree of protection IP20• For 8400 motec and protec.	DIAG	EZAEBK2003

4.1

Switch/potentiometer unit

The switch / potentiometer unit is fitted directly to the 8400 motec or in a different position within the system. An analogue setpoint can be specified with the switch/potentiometer unit and the control connections integrated in the inverter by using the integrated potentiometer; the rotary switch can, for example, be used to start/stop the drive or change the direction of rotation.

The switch/potentiometer unit is supplied with a 2.5 m connection cable.



Switch/potentiometer unit

Mode	Product key
Switch/potentiometer unit (IP65)	E82ZBU



System cables

For connection of the motor, Lenze provides finished hybrid cables. They are optimally matched to the connection between the Drive Package components. Motor connection, blower connection, brake connection and temperature monitoring are integrated in the cables. Cables up to a length of 100 m can be selected in increments of 0.1 m.

10-pole cables

Available with cross-sections 1.5² and 2.5² with connection for brake or thermal contact.

Product series	Cable type	Connection cable	Cable length in decimetres	Cable end on the motor side (socket)	Cable end on the controller side
E Y P Motor		A	0 0 0 3 5 0 0 0 Minimum length Maximum length		
Fixed installation	0 0 3 9	1.5 mm ²		H 0 7 Modular 16A	A 0 0 Without plug-in connector Q 0 8 Modular 40A
	0 0 4 0	2.5 mm ²		A 0 0 Without plug-in connector	Q 0 8 Modular 40A
	0 0 4 6	4.0 mm ²		H 0 8 Modular 16A	A 0 0 Without plug-in connector Q 0 9 Modular 40A
	0 0 4 7	10.0 mm ²		H 0 9 Modular 40A	A 0 0 Without plug-in connector Q 0 9 Modular 40A
				A 0 0 Without plug-in connector	Q 0 9 Modular 40A
				H 1 4 Modular 40A	A 0 0 Without plug-in connector
				H 1 5 Modular 40A	A 0 0 Without plug-in connector

Inverter Drives 8400 protec

Accessories



8-pole cables

Available with cross-sections 1.5² and 2.5² with connection for brake and thermal contact.

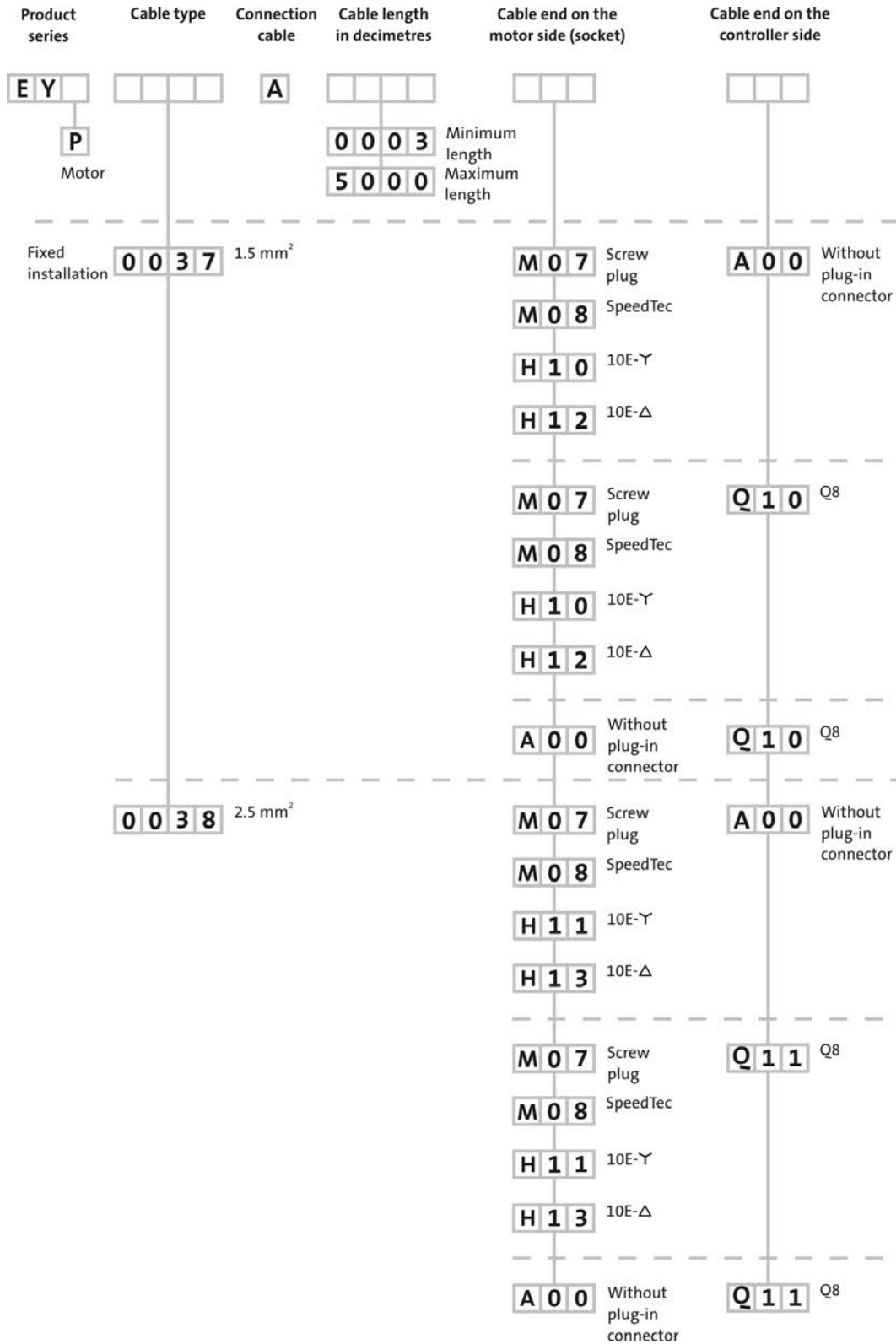

4.1

Inverter Drives 8400 protec

Accessories



4.1

Inverters

Inverter Drives 8400 motec

0.37 to 7.5 kW



Inverter Drives 8400 motec



Contents

General information	Product key	4.2 - 4	
	Equipment	4.2 - 5	
	List of abbreviations	4.2 - 6	
	8400 motec	4.2 - 7	
	Functions and features	4.2 - 8	
	Operating modes	4.2 - 9	
Technical data	Standards and operating conditions	4.2 - 11	
	Rated data 400 V	4.2 - 12	
	The three units	4.2 - 22	
	Drive Unit	4.2 - 23	
	Communication Unit	4.2 - 24	
	Wiring Unit	4.2 - 24	
	Mains connection	4.2 - 26	
	Motor connection	4.2 - 26	
	Connection diagrams	4.2 - 27	
	Control connections	4.2 - 28	
	Modules	Memory module	4.2 - 31
		Safety system (STO)	4.2 - 31
Communication modules		4.2 - 32	
Communication modules without fieldbus link		4.2 - 33	
Communication module: AS-Interface (AS-i)		4.2 - 34	
Communication module: CANopen		4.2 - 36	
EtherCAT® communication module		4.2 - 38	
EtherNet/IP communication module		4.2 - 40	
PROFIBUS communication module		4.2 - 42	
PROFINET communication module	4.2 - 44		
Accessories	Wiring Unit versions	4.2 - 47	
	Connector modules	4.2 - 47	
	Internal brake resistor	4.2 - 49	
	Wall mounting	4.2 - 49	
	Brake resistors	4.2 - 50	
	USB diagnostic adapter	4.2 - 51	
	Diagnosis terminal	4.2 - 52	
	Switch/potentiometer unit	4.2 - 52	
	System cables	4.2 - 53	

Inverter Drives 8400 motec

General information



Product key

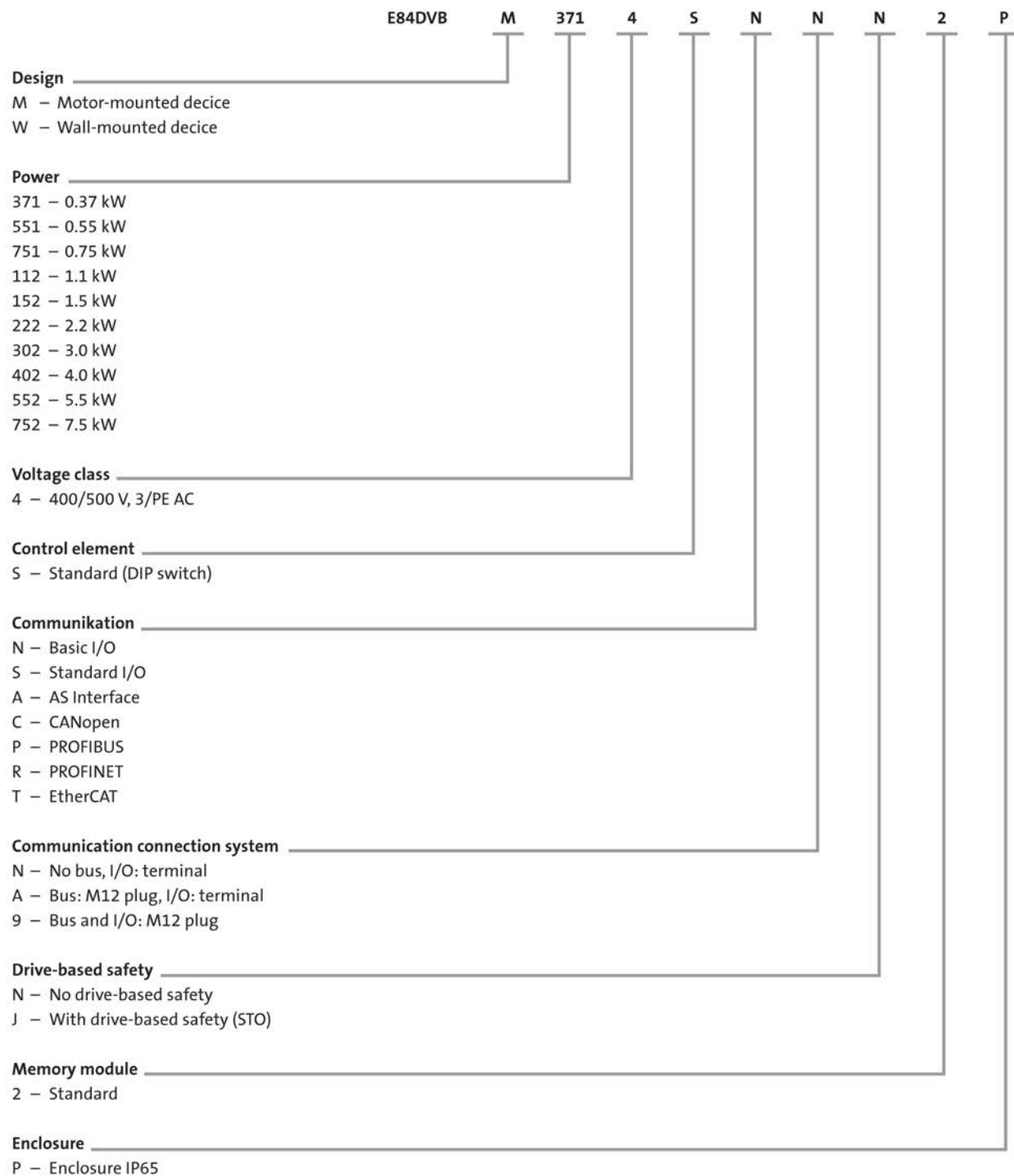

Inverter Drives 8400 motec

General information



Equipment

Status display
LED

L-force diagnostic interface

for USB adapter
when PC or keypad
is connected

Communication module

rotary so terminal
side is variable

Plug connection

The three parts of the
motec can be plugged
into one another

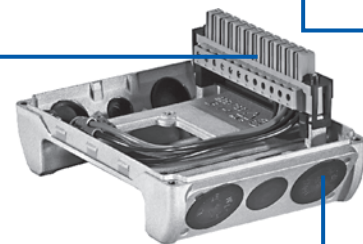
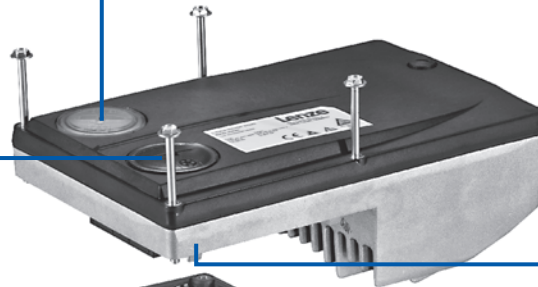

**DIP switch for
quick setting**

**Safety system
(STO)**

Optional in the
communication module

Plug connections

8 slots
A1 - A4 and B1 - B4

Power connections

Prepared for PG
Screwed connection
or plug-in module

4.2



List of abbreviations

b	[mm]	Dimensions
C _{th}	[KW _s]	Thermal capacity
f _{ch}	[kHz]	Rated switching frequency
h	[mm]	Dimensions
I _{N, out}	[A]	Rated output current
I _{N, AC}	[A]	Rated mains current
m	[kg]	Mass
n _{max}	[r/min]	Max. speed
P	[kW]	Typical motor power
P _V	[kW]	Power loss
P _N	[kW]	Rated power
R _N	[Ω]	Rated resistance
t	[mm]	Dimensions
U _{AC}	[V]	Mains voltage
U _{DC}	[V]	DC supply
U _{N, AC}	[V]	Rated voltage
U _{out}	[V]	Max. output voltage

ASM	Asynchronous motor
DIAG	Slot for diagnostic adapter
DIN	Deutsches Institut für Normung e.V.
EN	European standard
EN 60529	Degrees of protection provided by enclosures (IP code)
EN 60721-3	Classification of environmental conditions; Part 3: Classes of environmental parameters and their limit values
EN 61800-3	Electrical variable speed drives Part 3: EMC requirements including special test methods
IEC	International Electrotechnical Commission
IEC 61508	Functional safety of electrical/electronic/programmable electronic safety-related systems
IM	International Mounting Code
IP	International Protection Code
MCI	Slot for communication module (module communication interface)
NEMA	National Electrical Manufacturers Association
UL	Underwriters Laboratory Listed Product
UR	Underwriters Laboratory Recognized Product
VDE	Verband deutscher Elektrotechniker (Association of German Electrical Engineers)

Inverter Drives 8400 motec

General information



8400 motec

The Inverter Drives 8400 motec excel through the greatest possible user-friendliness during operation and installation.

Particularly when used for "basic applications", the Inverter Drives 8400 motec is able to demonstrate its exemplary efficiency with regard to costs, space, time and energy

Cost advantages

- The easiest commissioning processes via DIP switch and potentiometer settings
- Reduced energy requirements thanks to energy-saving functionalities in combination with the geared motors from Lenze

Space savings

- Integrated safety and fieldbus communication tailored to individual requirements
- Modular structure minimises your spare parts inventory

Time savings

- Reduction in assembly and installation times through pluggable connection system: "Unpack – plug in and use!"
- Easy replacement of the memory module simplifies standard set-up and increases availability

Energy efficiency

- The "VFC eco" mode offers intelligent adjustment of the magnetising current
- Energy savings of up to 30% in partial load operation

Further advantages

- 200% overload current (3s)
- V/f control with and without encoder
- Sensorless vector control
- Short-circuit and earth-fault protected
- DC-injection braking
- S-shaped ramp for smooth acceleration
- Max. output frequency 500 Hz
- 3 fixed frequencies
- CANopen, PROFIBUS, PROFINET, EtherCAT®, EtherNet/IP and AS-Interface
- STO safety function

Sympathetically easy

- The large LED display, which can still be read from great distances, displays the status during operation and uses various flashing sequences to provide information on error causes. This keeps diagnostics easy to understand

Mechanically and electrically robust

- Thanks to the high degree of protection (IP65), ideally suited for use in the harshest environments.

A win for decentralised applications

- The 8400 motec meets all requirements of a modern, universally deployable and cost-efficient motor inverter. This makes it ideally suited for decentralised duties in the field of intralogistics, such as at airports or distribution centres.



Inverter Drives 8400 motec

Inverter Drives 8400 motec

General information



Functions and features

Mode	8400 motec
Control types, motor control	
Sensorless vector control (SLVC)	For three-phase asynchronous motors
V/f control (VFCplus)	For three-phase AC motors and asynchronous servo motor (linear or square-law)
Energy saving function (VFC eco)	For three-phase asynchronous motors
Basic functions	<ul style="list-style-type: none"> Freely assignable user menu Parameter change-over DC brake function Flying restart circuit S-shaped ramps for smooth acceleration PID controller 3 fixed frequencies Masking frequencies
Technology applications	<ul style="list-style-type: none"> Speed actuating drive Switch-off positioning without feedback
Monitoring and protective measures	<ul style="list-style-type: none"> Short circuit Earth fault Overvoltage Motor phase failure Overcurrent I² x t-Motor monitoring Motor overtemperature Mains phase failure Protection for cyclical mains switching Motor stalling
Diagnostics	Data logger, logbook
Status display	1 LEDs
Diagnostic interface	Integrated For USB diagnostic adapter or keypad (diagnosis terminal)
Braking operation	
Brake chopper	Integrated
Brake resistor	Built-on module or external

4.2



Operating modes

An inverter enables energy-efficient operation of a system in virtually all application cases. The various operating modes, which can be created by making just a few simple settings, facilitate this. The following characteristics and corresponding specifications listed on the following pages can be used to calculate the optimum operating mode during the project planning phase.

Standard setting

In its initial state when delivered, the inverter is set up for basic operation with a three-phase AC motor with V/f control. When operated in this mode, the rated torque of the motor is available in a setting range up to 50 Hz.

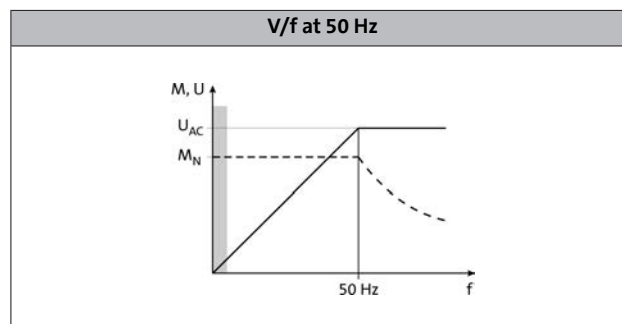

Extended setting range up to 87 Hz

If the V/f switchover point on the inverter is set to 87 Hz, the rated torque can be used across an extended setting range. Here, a 230/400V motor is for example used and operated in a delta layout with a 400V inverter. The setting range is then increased by 40 %. The inverter must be dimensioned for a rated motor current of 230 V.

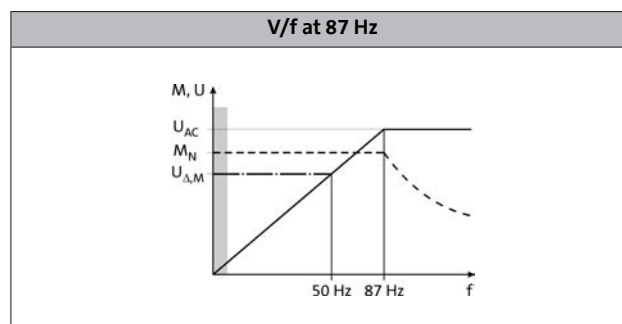

Operation with inverter-optimised MF motors

Large setting ranges and optimum operation at the rated torque: these are the strengths of the MF motor when used in combination with an inverter. The motors are optimised for a setting range up to 120 Hz. Compared to conventional 50Hz operation, the setting range increases by 250 %. It is quite simply not possible for a drive to be operated any more efficiently in a machine.

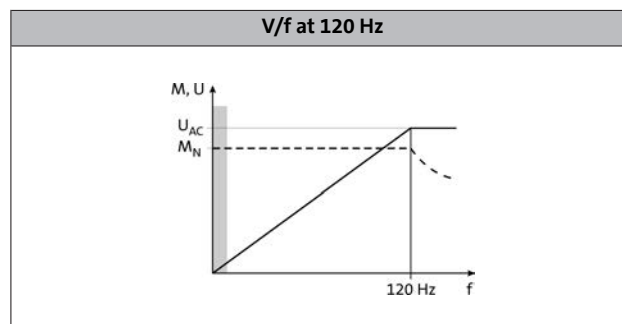

Operation with low loads

This operating mode can be used for various applications, e.g. for fans and pumps:

In fan and pump applications, the load behaviour follows a square-law characteristic depending on the speed. Often, an overload capacity of 120% is sufficient. This serves to operate the inverter during operation with increased power, i.e. the inverter can be dimensioned one power size smaller. The square-law characteristic which corresponds to the load behaviour can be set in the inverter.

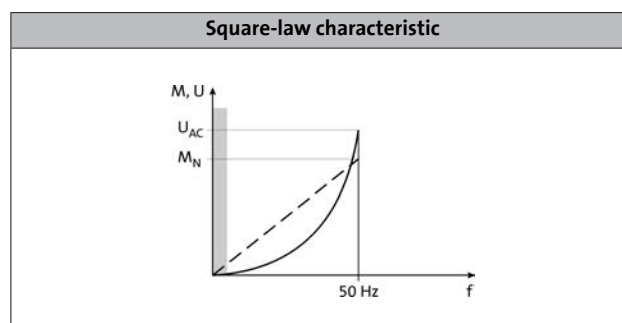

Inverter Drives 8400 motec



General information

Operating modes

VFC-eco energy saving mode

The Inverter Drives 8400 make energy saving especially easy with the "VFC eco" function. Particularly in the partial load operational range, this function significantly reduces energy requirements. Combined with the new L-force MF three-phase AC motors, this drive solution impresses with the maximum energy efficiency of a Lenze BlueGreen solution.

The "VFC eco" mode adjusts the magnetising current of a motor intelligently to actual requirements. This is particularly useful in partial load operational range, as this is precisely where three-phase AC motors need to be supplied with a greater magnetising current than the operating conditions actually require. The "VFC eco" mode allows losses to be reduced so much that savings of up to 30% can be achieved.

Energy efficiency can then be increased even further with the MF three-phase AC motors. These motors have been specifically designed for operation with frequency inverters. They operate at 120 Hz instead of 50 Hz, as 4-pole three-phase AC motors are at their most efficient at this frequency.

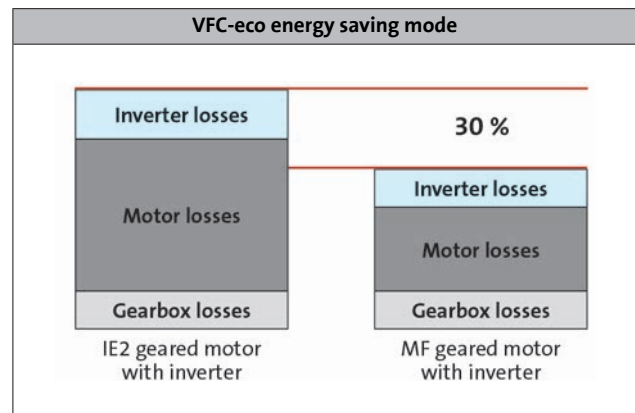

Overcurrent operation

The inverters can be driven at higher amperages beyond the rated current if the duration of this overcurrent operation is time limited. Two utilisation cycles with a duration of 15 s and 180 s are defined. Within these utilisation cycles, an overcurrent is possible for a certain time if afterwards an accordingly long recovery phase takes place. For both utilisation cycles, a moving average is determined separately. The adjacent diagram shows both cycles: 15 s in red and 180 s in blue. The overload times t_{o1} are 3 s (T_1) and 60 s (T_3) respectively, the corresponding recovery times t_{re} are 12 s (T_2) and 120 s (T_4) respectively. The following tables show the resulting maximum output currents. Monitoring of the device utilisation ($I \times t$) activates the set error response (trip or warning if one of the two utilisation values exceeds the limit of 100 %).

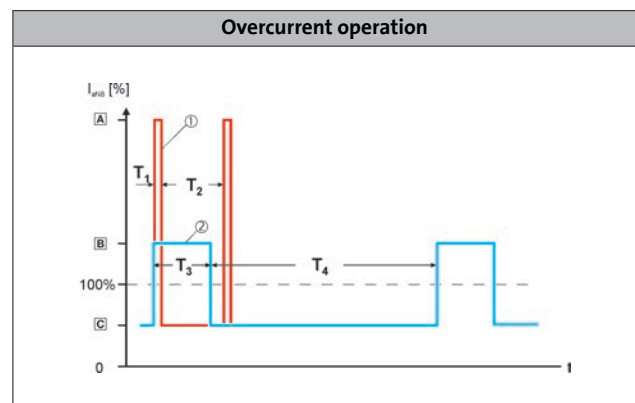

Switching frequencies

On an inverter, the term "switching frequency" is understood to mean the frequency with which the input and outputs of the output module (inverter) are switched. On an inverter, the switching frequency can generally be set to values between 2 and 16 kHz, whereby the selection is based on the respective power output.

Since losses (in the form of heat) can be generated when switching the modules, the inverter can provide a higher output current at a switching frequency of 2 kHz. In addition to this, it is also important to differentiate between operation at a fixed switching frequency and a variable switching frequency, whereby the switching frequency is automatically reduced based on the output current here.

The data for operation at increased output is permitted for operation at a switching frequency of 2 or 4 kHz and in an ambient temperature of max. 40 °C.



Standards and operating conditions

Mode			
Product			8400 motec
Conformity			
CE			Low-Voltage Directive 2006/95/EG
Approval			
UL 508C			Power Conversion Equipment (File-No. E170350)
CSA			CSA 22.2 No. 14
Certification			
			GOST-R
Degree of protection			
EN 60529			IP65 ¹⁾
NEMA 250			Type 4
Climatic conditions			
Storage (EN 60721-3-1)			1K3 (temperature: -30 °C ... +60 °C)
Transport (EN 60721-3-2)			2K3 (temperature: -30 °C ... +75 °C)
Operation (EN 60721-3-3)			3K3 (temperature: -30 °C ... +55 °C)
Current derating at over 45 °C			2.5% / K
Site altitude			
Amsl	H _{max}	[m]	4000
Current derating at over 1000 m		[%/1000 m]	5
Vibration resistance			
Transport (EN 60721-3-2)			2M2
Operation (EN 60721-3-3)			3M6
Operation (Germanischer Lloyd)			General conditions: acceleration resistant up to 2 g

4.2

Mode			
Product			8400 motec
Supply form			
			Systems with earthed star point (TN and TT systems) Systems with high-resistance or isolated star point (IT systems)
Noise emission			
EN 61800-3			Integrated radio interference suppression measures: conducted, category C1 ²⁾ Wall mounting: category C2 with a shielded motor cable of up to 20 m
Insulation resistance			
EN 61800-5-1			≤ 2000 m amsl overvoltage category III > 2000 m amsl overvoltage category II
Degree of pollution			
EN 61800-5-1			2
Protective insulation of control circuits			
EN 61800-5-1			Safe mains isolation: double/reinforced insulation

¹⁾ Not with plug-in or braking resistor modules.

²⁾ Category C2 above 4.0 kW.

Inverter Drives 8400 motec

Technical data



Rated data 400 V

- The data is valid for operation at 400 V AC.
- Unless otherwise specified, the data refers to the default setting.

Typical motor power						
4-pole asynchronous motor	P	[kW]	0.37	0.55 ¹⁾	0.55	0.75 ¹⁾
Product key						
Inverter			E84DVB□3714S□□□2□		E84DVB□5514S□□□2□	
Drive Unit			E84DGDVB37142PS		E84DGDVB55142PS	
Mains voltage range						
	U _{AC}	[V]	3/PE AC 320 V-0 % ... 528 V+0 %, 45 Hz-0 % ... 65 Hz+0 %			
Rated mains current						
	I _{N, AC}	[A]	1.3	1.6	1.8	2.2
Rated output current						
	I _{N, out}	[A]	1.3	1.6	1.8	2.2
Rated switching frequency						
	f _{ch}	[kHz]	8	4	8	4
Output current						
4 kHz	I _{out}	[A]	1.3	1.6	1.8	2.2
8 kHz	I _{out}	[A]	1.3		1.8	
16 kHz	I _{out}	[A]	0.9		1.2	

4.2

Data for 60 s overload

Max. output current				
	I _{max, out}	[A]	2.0	2.7
Overload time				
	t _{ol}	[s]	60.0	
Recovery time				
	t _{re}	[s]	120.0	

Data for 3 s overload

Max. short-time output current				
	I _{max, out}	[A]	2.6	3.6
Overload time				
	t _{ol}	[s]	3.0	
Recovery time				
	t _{re}	[s]	12.0	

¹⁾ Increased rated power operating mode at 40 °C ambient temperature and max. mains voltage of 400 V AC

Inverter Drives 8400 motec



Technical data

Rated data 400 V

- The data is valid for operation at 400 V AC.
- Unless otherwise specified, the data refers to the default setting.

						
Typical motor power						
4-pole asynchronous motor	P	[kW]	0.37	0.55 ¹⁾	0.55	0.75 ¹⁾
Product key						
Inverter			E84DVB□3714S□□□□2□		E84DVB□5514S□□□□2□	
Drive Unit			E84DGDVB37142PS		E84DGDVB55142PS	
Power loss						
	P _V	[kW]	0.026		0.033	
Mass						
	m	[kg]	2.6			
Max. cable length						
Shielded motor cable ²⁾	l _{max}	[m]	20			

4.2

Brake chopper rated data

Rated power, Brake chopper						
	P _N	[kW]	0.4	0.5	0.6	0.7
Max. output power, Brake chopper						
	P _{max, 1}	[kW]	0.6		0.8	
Min. brake resistance						
	R _{min}	[Ω]	180.0			

Dimensions

Dimensions						
Height	h	[mm]	109			
Width	b	[mm]	161			
Depth	t	[mm]	241			

¹⁾ Increased rated power operating mode at 40 °C ambient temperature and max. mains voltage of 400 V AC

²⁾ Technically possible cable lengths, irrespective of EMC requirements

Inverter Drives 8400 motec

Technical data



Rated data 400 V

- The data is valid for operation at 400 V AC.
- Unless otherwise specified, the data refers to the default setting.

Typical motor power						
4-pole asynchronous motor	P	[kW]	0.75	1.10 ¹⁾	1.10	1.50 ¹⁾
Product key						
Inverter			E84DVB□7514S□□□□2□		E84DVB□1124S□□□□2□	
Drive Unit			E84DGDVB75142PS		E84DGDVB11242PS	
Mains voltage range						
	U _{AC}	[V]	3/PE AC 320 V-0 % ... 528 V+0 %, 45 Hz-0 % ... 65 Hz+0 %			
Rated mains current						
	I _{N, AC}	[A]	2.4	2.9	3.2	3.8
Rated output current						
	I _{N, out}	[A]	2.4	2.9	3.2	3.8
Rated switching frequency						
	f _{ch}	[kHz]	8	4	8	4
Output current						
4 kHz	I _{out}	[A]	2.4	2.9	3.2	3.8
8 kHz	I _{out}	[A]	2.4		3.2	
16 kHz	I _{out}	[A]	1.6		2.1	

Data for 60 s overload

Max. output current				
	I _{max, out}	[A]	3.6	4.8
Overload time				
	t _{ol}	[s]	60.0	
Recovery time				
	t _{re}	[s]	120.0	

Data for 3 s overload

Max. short-time output current				
	I _{max, out}	[A]	4.8	6.4
Overload time				
	t _{ol}	[s]	3.0	
Recovery time				
	t _{re}	[s]	12.0	

¹⁾ Increased rated power operating mode at 40 °C ambient temperature and max. mains voltage of 400 V AC

Inverter Drives 8400 motec



Technical data

Rated data 400 V

- The data is valid for operation at 400 V AC.
- Unless otherwise specified, the data refers to the default setting.

						
Typical motor power						
4-pole asynchronous motor	P	[kW]	0.75	1.10 ¹⁾	1.10	1.50 ¹⁾
Product key						
Inverter			E84DVB□7514S□□□□2□		E84DVB□1124S□□□□2□	
Drive Unit			E84DGDVB75142PS		E84DGDVB11242PS	
Power loss						
	P _V	[kW]	0.041		0.052	
Mass						
	m	[kg]	2.6			
Max. cable length						
Shielded motor cable ²⁾	l _{max}	[m]	20			

4.2

Brake chopper rated data

Rated power, Brake chopper						
	P _N	[kW]	0.8	0.9	1.1	1.3
Max. output power, Brake chopper						
	P _{max, 1}	[kW]	1.3		1.7	
Min. brake resistance						
	R _{min}	[Ω]	180.0			

Dimensions

Dimensions						
Height	h	[mm]	109			
Width	b	[mm]	161			
Depth	t	[mm]	241			

¹⁾ Increased rated power operating mode at 40 °C ambient temperature and max. mains voltage of 400 V AC

²⁾ Technically possible cable lengths, irrespective of EMC requirements

Inverter Drives 8400 motec



Technical data

Rated data 400 V

- The data is valid for operation at 400 V AC.
- Unless otherwise specified, the data refers to the default setting.

						
Typical motor power						
4-pole asynchronous motor	P	[kW]	1.50	2.20 ¹⁾	2.20	3.00 ¹⁾
Product key						
Inverter			E84DVB□1524S□□□2□		E84DVB□2224S□□□2□	
Drive Unit			E84DGDVB15242PS		E84DGDVB22242PS	
Mains voltage range						
	U _{AC}	[V]	3/PE AC 320 V-0 % ... 528 V+0 %, 45 Hz-0 % ... 65 Hz+0 %			
Rated mains current						
	I _{N, AC}	[A]	3.8	4.5	5.6	6.7
Rated output current						
	I _{N, out}	[A]	3.9	4.7	5.6	6.7
Rated switching frequency						
	f _{ch}	[kHz]	8	4	8	4
Output current						
4 kHz	I _{out}	[A]	3.9	4.7	5.6	6.7
8 kHz	I _{out}	[A]	3.9		5.6	
16 kHz	I _{out}	[A]	2.6		3.7	

4.2

Data for 60 s overload

Max. output current						
	I _{max, out}	[A]	5.9		8.4	
Overload time						
	t _{ol}	[s]	60.0			
Recovery time						
	t _{re}	[s]	120.0			

Data for 3 s overload

Max. short-time output current						
	I _{max, out}	[A]	7.8		11.2	
Overload time						
	t _{ol}	[s]	3.0			
Recovery time						
	t _{re}	[s]	12.0			

¹⁾ Increased rated power operating mode at 40 °C ambient temperature and max. mains voltage of 400 V AC

Inverter Drives 8400 motec



Technical data

Rated data 400 V

- The data is valid for operation at 400 V AC.
- Unless otherwise specified, the data refers to the default setting.

						
Typical motor power						
4-pole asynchronous motor	P	[kW]	1.50	2.20 ¹⁾	2.20	3.00 ¹⁾
Product key						
Inverter			E84DVB□1524S□□□2□		E84DVB□2224S□□□2□	
Drive Unit			E84DGDVB15242PS		E84DGDVB22242PS	
Power loss						
	P _V	[kW]	0.061		0.088	
Mass						
	m	[kg]	2.6		3.5	
Max. cable length						
Shielded motor cable ²⁾	l _{max}	[m]	20			

4.2

Brake chopper rated data

Rated power, Brake chopper						
	P _N	[kW]	1.5	1.8	2.2	2.6
Max. output power, Brake chopper						
	P _{max, 1}	[kW]	2.3		3.3	
Min. brake resistance						
	R _{min}	[Ω]	180.0		100.0	

Dimensions

Dimensions				
Height	h	[mm]	109	135
Width	b	[mm]	161	176
Depth	t	[mm]	241	261

¹⁾ Increased rated power operating mode at 40 °C ambient temperature and max. mains voltage of 400 V AC

²⁾ Technically possible cable lengths, irrespective of EMC requirements



Inverter Drives 8400 motec



Technical data

Rated data 400 V

- The data is valid for operation at 400 V AC.
- Unless otherwise specified, the data refers to the default setting.

						
Typical motor power						
4-pole asynchronous motor	P	[kW]	3.00	4.00 ¹⁾	4.00	5.50 ¹⁾
Product key			E84DVB□3024S□□□2□		E84DVB□4024S□□□2□	
Inverter			E84DVB□3024S□□□2□		E84DVB□4024S□□□2□	
Drive Unit			E84DGDVB30242PS		E84DGDVB40242PS	
Mains voltage range			3/PE AC 320 V-0 % ... 528 V+0 %, 45 Hz-0 % ... 65 Hz+0 %			
	U_{AC}	[V]				
Rated mains current						
	$I_{N, AC}$	[A]	7.2	8.6	9.3	11.1
Rated output current						
	$I_{N, out}$	[A]	7.3	8.7	9.5	11.4
Rated switching frequency						
	f_{ch}	[kHz]	8	4	8	4
Output current						
4 kHz	I_{out}	[A]	7.3	8.7	9.5	11.4
8 kHz	I_{out}	[A]	7.3		9.5	
16 kHz	I_{out}	[A]	4.9		6.3	

Data for 60 s overload

Max. output current						
	$I_{max, out}$	[A]	11.0		14.3	
Overload time						
	t_{ol}	[s]	60.0			
Recovery time						
	t_{re}	[s]	120.0			

Data for 3 s overload

Max. short-time output current						
	$I_{max, out}$	[A]	14.6		19.0	
Overload time						
	t_{ol}	[s]	3.0			
Recovery time						
	t_{re}	[s]	12.0			

¹⁾ Increased rated power operating mode at 40 °C ambient temperature and max. mains voltage of 400 V AC



Inverter Drives 8400 motec



Technical data

Rated data 400 V

- The data is valid for operation at 400 V AC.
- Unless otherwise specified, the data refers to the default setting.

						
Typical motor power						
4-pole asynchronous motor	P	[kW]	3.00	4.00 ¹⁾	4.00	5.50 ¹⁾
Product key			E84DVB□3024S□□□2□		E84DVB□4024S□□□2□	
Inverter			E84DVB□3024S□□□2□		E84DVB□4024S□□□2□	
Drive Unit			E84DGDVB30242PS		E84DGDVB40242PS	
Power loss						
	P _V	[kW]	0.11		0.14	
Mass						
	m	[kg]	3.5		5.3	
Max. cable length						
Shielded motor cable ²⁾	l _{max}	[m]	20			

4.2

Brake chopper rated data

Rated power, Brake chopper						
	P _N	[kW]	3.0		4.0	
Max. output power, Brake chopper						
	P _{max,1}	[kW]	4.5		5.5	
Min. brake resistance						
	R _{min}	[Ω]	100.0		47.0	

Dimensions

Dimensions				
Height	h	[mm]	135	176
Width	b	[mm]	176	195
Depth	t	[mm]	261	325

¹⁾ Increased rated power operating mode at 40 °C ambient temperature and max. mains voltage of 400 V AC

²⁾ Technically possible cable lengths, irrespective of EMC requirements

Inverter Drives 8400 motec

Technical data



Rated data 400 V

- The data is valid for operation at 400 V AC.
- Unless otherwise specified, the data refers to the default setting.

						
Typical motor power						
4-pole asynchronous motor	P	[kW]	5.50	7.50 ¹⁾	7.50	9.20 ¹⁾
Product key						
Inverter			E84DVB□5524S□□□□2□		E84DVB□7524S□□□□2□	
Drive Unit			E84DGDVB55242PS		E84DGDVB75242PS	
Mains voltage range						
	U _{AC}	[V]	3/PE AC 320 V-0 % ... 528 V+0 %, 45 Hz-0 % ... 65 Hz+0 %			
Rated mains current						
	I _{N, AC}	[A]	12.8	15.3	16.3	19.5
Rated output current						
	I _{N, out}	[A]	13.0	15.6	16.5	19.8
Rated switching frequency						
	f _{ch}	[kHz]	8	4	8	4
Output current						
4 kHz	I _{out}	[A]	13.0	15.6	16.5	19.8
8 kHz	I _{out}	[A]	13.0		16.5	
16 kHz	I _{out}	[A]	8.6		10.9	

Data for 60 s overload

Max. output current						
	I _{max, out}	[A]	19.5		24.7	
Overload time						
	t _{ol}	[s]	60.0			
Recovery time						
	t _{re}	[s]	120.0			

Data for 3 s overload

Max. short-time output current						
	I _{max, out}	[A]	26.0		33.0	
Overload time						
	t _{ol}	[s]	3.0			
Recovery time						
	t _{re}	[s]	12.0			

¹⁾ Increased rated power operating mode at 40 °C ambient temperature and max. mains voltage of 400 V AC

Inverter Drives 8400 motec



Technical data

Rated data 400 V

- The data is valid for operation at 400 V AC.
- Unless otherwise specified, the data refers to the default setting.

						
Typical motor power						
4-pole asynchronous motor	P	[kW]	5.50	7.50 ¹⁾	7.50	9.20 ¹⁾
Product key			E84DVB□524S□□□□2□		E84DVB□7524S□□□□2□	
Inverter						
Drive Unit			E84DGDVB55242PS		E84DGDVB75242PS	
Power loss						
	P _V	[kW]	0.18		0.23	
Mass						
	m	[kg]	5.3			
Max. cable length						
Shielded motor cable	l _{max}	[m]	20			

4.2

Brake chopper rated data

Rated power, Brake chopper						
	P _N	[kW]	5.5	6.6	7.5	9.2
Max. output power, Brake chopper						
	P _{max,1}	[kW]	7.5		9.2	
Min. brake resistance						
	R _{min}	[Ω]	47.0			

Dimensions

Dimensions				
Height	h	[mm]	176	
Width	b	[mm]	195	
Depth	t	[mm]	325	

¹⁾ Increased rated power operating mode at 40 °C ambient temperature and max. mains voltage of 400 V AC

²⁾ Technically possible cable lengths, irrespective of EMC requirements

Inverter Drives 8400 motec

Technical data



The three units

As a drive package, the Inverter Drives 8400 motec is supplied pre-installed on the geared motor. If the 8400 motec is ordered separately, it is easy to install on the motor or the wall using just four screws. The flexibility offered by the 8400 motec is underlined by its modular and cleverly designed structure, consisting of the "drive unit", "communication unit" and "wiring unit" modules.

If the 8400 motec is ordered individually, the various "units" to be supplied can be selected separately. Details on the functions of the individual units:

Drive unit

- Inverter power section
- Easy commissioning via DIP switch, potentiometer or diagnosis terminal
- An easily changeable memory module
- A large LED display to show statuses

Communication unit

- Interface for I/Os and fieldbus links
- AS-Interface, CANopen, EtherCAT®, EtherNet/IP, PROFIBUS or PROFINET
- I/Os and on-board safety
- Pluggable M12 connection system

Wiring Unit

- Connections to the mains and to the drive
- Flexible connection options such as cable glands and diverse plug-in connectors
- Connection for brake resistor
- Connection for spring-applied brake

4.2

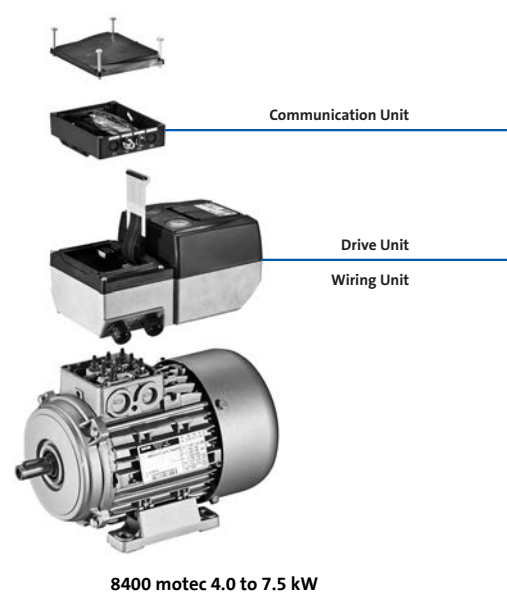
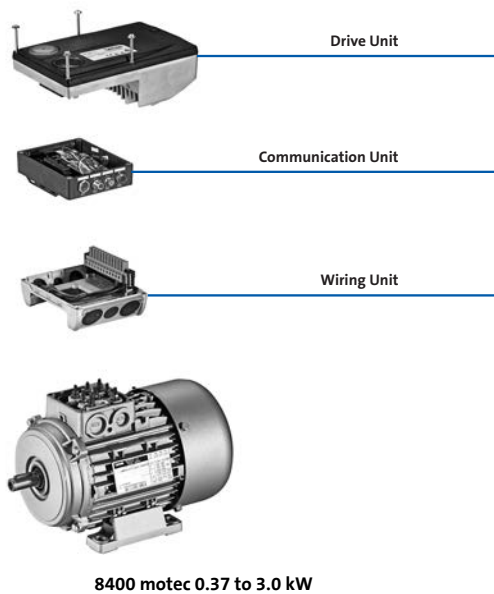

Inverter Drives 8400 motec

Technical data



Drive Unit

Alongside the power section, the underside of the drive unit also houses several DIP switches and potentiometers, with which the inverter can easily be commissioned. These allow the configuration, speed and ramp to be adjusted. The drive can, for example, then be quickly and easily adapted to match the system.

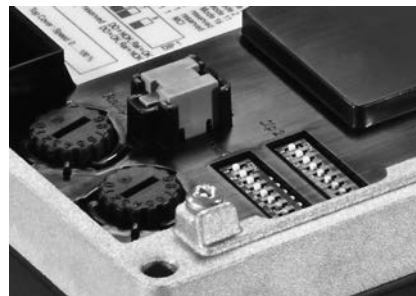

Dip switches on Drive Unit

For the purpose of diagnostics, you can plug in a diagnostic adapter alongside the status display without having to disassemble the drive. Thanks to the potentiometer that can be accessed from above, you can make speed settings while the motor is actually running.

4.2



Drive Unit diagnostic terminal



Drive Unit diagnostic terminal



Communication Unit

The communication modules support the following functions:

- Control of the inverter via digital and analog signals
- Control of the inverter via the fieldbus systems
- Support for the "safe torque off" functionality
- Connection options for sensors and actuators
- The sensors can be powered by the internal 24 V supply
- Connection options via cable glands and M12 connectors. A total of up to 8 screwed connections / plugs can be used. Based on their function, the individual communication units are equipped with the corresponding connections as standard.



Communication Unit

Designs

- Basic I/O
- Standard I/O
- Application I/O
- AS-i
- CANopen
- EtherCAT®
- EtherNet/IP
- PROFIBUS
- PROFINET

Wiring Unit

The wiring unit forms the interface between the various motor frame sizes and inverters. In addition to this, it provides the flexibility in terms of connection options for power, motor, brake and brake resistance.

The wiring unit also acts as a holder for various additional modules such as :

- Wall mounting
- Q5/0 plug-in module
as Q5/0 plug connection or loop-through connection
- Q4/2 plug-in module
as Q4/2 plug connection or loop-through connection
- Q8/0 plug-in module
as Q8/0 plug connection for the motor when wall mounted
- Integrated brake resistor
for braking operation via the integrated brake chopper

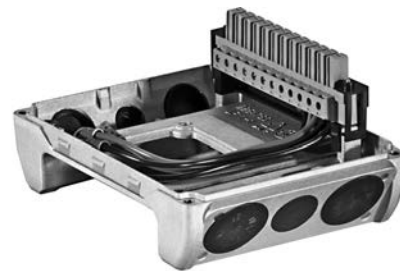

Wiring Unit

Inverter Drives 8400 motec

Technical data





Mains connection

- ▶ The mains fuse and cable cross-section specifications are for a mains connection of 3 x 400 V.
- ▶ Class gG/gI fuses or class gRL semiconductor fuses.
- ▶ The cable cross-sections apply to PVC-insulated copper cables.
- ▶ Use for installation with UL-approved cables, fuses and brackets.

Typical motor power	Mains voltage	Product key	Circuit breaker	Fuse		Mains connection				
				EN 60204-1	UL					
4-pole asynchronous motor		Inverter				Cross-section (without mains choke)				
P	U _{AC}		I	I	I	q				
[kW]	[V]		[A]	[A]	[A]	[mm ²]				
0.37	3 AC 320 ... 528	E84DVB□3714S□□□2□	C16	16	15	2.5				
0.55		E84DVB□5514S□□□2□								
0.75		E84DVB□7514S□□□2□								
1.10		E84DVB□1124S□□□2□								
1.50		E84DVB□1524S□□□2□								
2.20		E84DVB□2224S□□□2□								
3.00		E84DVB□3024S□□□2□								
4.00		E84DVB□4024S□□□2□								
5.50		E84DVB□5524S□□□2□					C20	20	20	4.0
7.50		E84DVB□7524S□□□2□								

Motor connection

- ▶ Keep motor cables as short as possible, as this has a positive effect on the drive behaviour.
- ▶ With group drives (multiple motors on one inverter), the resulting cable length is the key factor. This can be calculated using the hardware manual.
- ▶ Electric strength of the motor cable: 1 kV as per VDE 250-1.

Typical motor power	Mains voltage	Product key	Max. cable length	
			shielded C2 without external measures	shielded C2 with external measures
4-pole asynchronous motor		Inverter		
P	U _{AC}		l _{max}	l _{max}
[kW]	[V]		[m]	[m]
0.37	3 AC 320 ... 528	E84DVB□3714S□□□2□	20	20
0.55		E84DVB□5514S□□□2□		
0.75		E84DVB□7514S□□□2□		
1.10		E84DVB□1124S□□□2□		
1.50		E84DVB□1524S□□□2□		
2.20		E84DVB□2224S□□□2□		
3.00		E84DVB□3024S□□□2□		
4.00		E84DVB□4024S□□□2□		
5.50		E84DVB□5524S□□□2□		
7.50		E84DVB□7524S□□□2□		

Inverter Drives 8400 motec

Technical data



Connection diagrams

Wiring example for connecting Inverter Drives 8400 motec to 3 x 400V

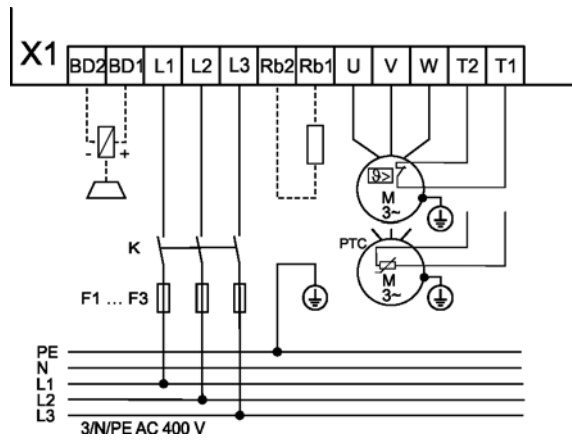



Control connections: Standard I/O

Mode	
Product	8400 motec
Analog inputs	
Number	1 Switchable: voltage or current input
Resolution	10 bits
Value range	0 ... 10V, 0/4 ... 20mA
Digital inputs	
Number	6 (5 + 1 controller enable)
Switching level	PLC (IEC 61131-2)
Max. input current	11 mA
Function	
Digital outputs	
Number	1
Switching level	PLC (IEC 61131-2)
Max. output current	50 mA
Relay	
Number	1
Contact	NO contact
AC connection	250V, 3A
DC connection	24V, 2A ... 240V, 0.16A
External 24 V DC supply	
	To support communication when the 400 V is switched off
Internal 24 V DC supply	
	Max. 100 mA for inputs/outputs and sensor feeds
Interfaces	
CANopen	
Extensions	Fieldbus via communication unit
Safety engineering	1 safe input for passive/active actuators
Drive interface	
Encoder input	Via 2 digital inputs, HTL, 2-track, 10 kHz

4.2

Additional connections

All connections are generally connected internally to terminals. The most common connections of the Communication Unit already have plug connectors. If additional connections are to be implemented, these can be designed as standard PG glands.

Inverter Drives 8400 motec

Technical data



Control connections

Connection of analog inputs and outputs, Basic I/O

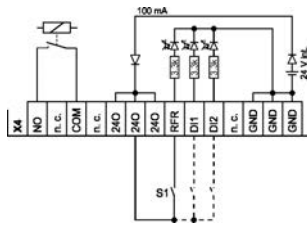

Connection of analog inputs and outputs, Standard I/O

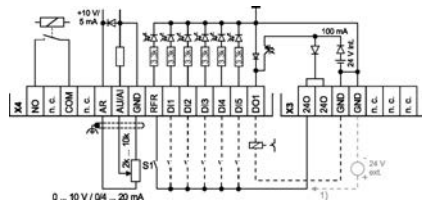

Inverter Drives 8400 motec

Technical data



Inverter Drives 8400 motec



Modules

Memory module

All drive settings for the 8400 are stored on the memory module, which is a pluggable memory chip. The memory module ensures that drives can be replaced quickly and without errors being made.

Module	Features	Product key
Memory module	<ul style="list-style-type: none"> For 8400 Baseline, 8400 motec Packaging unit: 12 items 	E84AYM20S/M

Safety engineering

The "safe torque off (STO)" safety function can be integrated into the Communication Unit in addition to the communication module. This combination is available with any bus.

Communication module	AS-Interface STO	CANopen STO	EtherCAT STO	EtherNet/IP STO	PROFIBUS STO	PROFINET STO
Certification						
EN ISO 13849-1	PLe Category 4					
EN 61800-5-2	SIL 3					
EN 62061	SIL 3					
IEC 61508	SIL 3					
Fail-safe state	Safe torque off					



Communication modules

Various communication modules can be installed in the communication unit. They serve to connect the L-force Inverter Drives 8400 motec to a bus system.

Overview

Communication module	Controller enable Number	Digital inputs Number	Digital outputs Number	Relay outputs Number	Analog inputs Number	Safety STO Number	External 24 V DC supply Number
Basic I/O	1	2		1			
Standard I/O	1	5	1	1	1		
AS-Interface	1	5	1				
Application I/O							
AS-Interface STO	1	5	1	1	1	1	
CANopen	1	5	1				
CANopen STO	1	5	1	1	1	1	
EtherCAT	1	5	1				1
EtherCAT STO	1	5	1	1	1	1	1
EtherNet/IP	1	5	1				1
EtherNet/IP STO	1	5	1	1	1	1	1
PROFIBUS	1	5	1				1
PROFIBUS STO	1	5	1	1	1	1	1
PROFINET	1	5	1				1
PROFINET STO	1	5	1	1	1	1	1

► STO: Safe Torque Off

Inverter Drives 8400 motec



Modules

Communication modules without fieldbus link

The following modules are available for controlling the 8400 motec via digital signals:

- Basic I/O
- Standard I/O
- Application I/O



The Basic I/O function module provides the inverter with a minimum number of digital inputs and outputs for the most basic applications.

The Standard I/O function module provides the inverter with an extended number of digital inputs and outputs and is primarily intended for standard applications.

The Application I/O function module provides the inverter with one additional digital input and output over the Standard I/O and is intended for use with more complex applications.



Basic I/O, Standard I/O or Application I/O

Mode		Features	Number of free slots	Product key
Communication module				
Basic I/O		<ul style="list-style-type: none"> • 2 digital inputs • Controller enable • 1 relay 	8	E84DGFNC□NP
Standard I/O		<ul style="list-style-type: none"> • Controller enable • 5 digital inputs • 1 digital output • 1 analog input • 1 relay 	8	E84DGFCS□NP
Application I/O		<ul style="list-style-type: none"> • Controller enable • 6 digital inputs • 1 digital output • 2 analogue inputs (-10/0 to 10 V or 0/4 to 20 mA) • 1 relay 	8	E84DGFCC□JP

4.2

Standards and operating conditions

Product key			E84DGFNC□NP	E84DGFCS□NP	E84DGFCC□JP
Mode			Basic I/O	Standard I/O	Application I/O
Degree of protection			IP65		
EN 60529			IP65		
Climatic conditions					
Storage (EN 60721-3-1)			1K3 (temperature: -30 °C ... +60 °C)		
Operation (EN 60721-3-3)			3K3 (temperature: -30 °C ... +55 °C)		
Transport (EN 60721-3-2)			2K3 (temperature: -30 °C ... +75 °C)		
Insulation voltage to reference earth/PE					
EN 61800-5-1	U_{AC}	[V]	50.0		

Pin assignment

In the case of the communication modules without fieldbus connection, only the variant "I/O terminal" is provided. It is connected by means of the cable gland.

Inverter Drives 8400 motec

Modules



Communication module: AS-Interface (AS-i)

The AS-Interface communication module enables you to control the 8400 motec using digital control signals. The AS-i bus system has become the established solution for transferring digital signals on the lowest field level. It is designed for applications that do not require the use of powerful fieldbus systems.



The advantages of this system are:

- Easy handling and commissioning
- Less wiring effort
- Can be easily integrated into existing systems
- Cost reductions



Communication module: AS-Interface (AS-i)

4.2

Mode		Features	Number of free slots	Product key
Communication module				
AS-Interface		<ul style="list-style-type: none"> • Acyclical polling of diagnostic data • Acyclical reading and writing of parameter sets • Cyclical drive control • Cyclical reading and writing of individual parameters • Controller enable • 5 digital inputs • 1 digital output • 4 digital inputs for when power is supplied via the AS-i bus and there is no mains supply 	6	E84DGFC□NP
AS-Interface STO		<ul style="list-style-type: none"> • Acyclical polling of diagnostic data • Acyclical reading and writing of parameter sets • Cyclical drive control • Cyclical reading and writing of individual parameters • Controller enable • 5 digital inputs • 1 digital output • 4 digital inputs for when power is supplied via the AS-i bus and there is no mains supply • 1 analog input • 1 relay • Safety function STO 	6	E84DGFC□JP

Standards and operating conditions

Product key			E84DGFC□NP	E84DGFC□JP
Mode			AS-Interface	AS-Interface STO
Communication module				
Degree of protection			IP65	
EN 60529				
Climatic conditions				
Storage (EN 60721-3-1)			1K3 (temperature: -30 °C ... +60 °C)	
Operation (EN 60721-3-3)			3K3 (temperature: -30°C ... +55°C)	
Transport (EN 60721-3-2)			2K3 (temperature: -30 °C ... +75 °C)	
Insulation voltage to reference earth/PE				
EN 61800-5-1	U _{AC}	[V]	50.0	



Communication module: AS-Interface (AS-i)

Technical data

Product key			
Communication module			E84DGFCANP E84DGFCBJP
Standard			
			EN 50295 / IEC 62026-2
Communication			
Communication profile			AS-Interface V3.0
Medium			2-wire cable for data and auxiliary power
Network topology			
			Free topology (line, ring, tree, star)
Node			
			Slave (single or dual) max. 31 standard slaves or safe slaves Max. 62 A/B Slaves
Number of bus nodes			
			1 ... 31
Max. cable length			
per bus segment	I_{max}	[m]	100 without repeaters / extenders 300 including 2 repeaters / extenders 500 only for star-shaped mains including repeaters / extenders
Baud rate			
		[kBit/s]	167 (gross value) 53 (net with data transfer efficiency = 32%)
Rated voltage			
DC	$U_{N,DC}$	[V]	24.0

4.2

Pin assignment

Can be quickly connected to the bus and certain inputs/outputs via 5-pin M12 connector of the Communication Unit.

The connector is A-coded and can be connected using an AS-i cable featuring penetration technology.

Mode	Variant	Product key	Slot							
Communication module	Communication module		A1	A2	A3	A4	B1	B2	B3	B4
AS-Interface	I/O terminal	E84DGFCANP	LED	ASi	DI1 DI2	DI3 DI4				
	I/O 2xM12	E84DGFCANP								
AS-Interface STO	I/O terminal	E84DGFCBJP								
	I/O 2xM12	E84DGFCBJP								

- ▶ DI1 to DI4= digital inputs
- ▶ LED= status display for bus communication

Inverter Drives 8400 motec



Modules

Communication module: CANopen



The CANopen communication module allows you to control the 8400 motec by sending digital control signals via the "CANopen" bus system.

The advantages of this system are:

- Straightforward, yet extremely powerful, bus system
- Cost-effective
- Easy system integration, as there is a wide range of sensors and actuators available on the market



Communication module: CANopen

Mode		Features	Number of free slots	Product key
Communication module				
CANopen		<ul style="list-style-type: none"> • Addressing via DIP switches or parameters • Internal 24 V DC supply • Controller enable • 5 digital inputs • 1 digital output 	6	E84DGFCC□NP
CANopen STO		<ul style="list-style-type: none"> • Addressing via DIP switches or parameters • Internal 24 V DC supply • Controller enable • 5 digital inputs • 1 digital output • 1 analog input • 1 relay • Safety function STO 	6	E84DGFCC□JP

4.2

Standards and operating conditions

Product key			E84DGFCC□NP	E84DGFCC□JP
Mode			CANopen	CANopen STO
Communication module				
Degree of protection			IP65	
EN 60529				
Climatic conditions				
Storage (EN 60721-3-1)			1K3 (temperature: -30 °C ... +60 °C)	
Operation (EN 60721-3-3)			3K3 (temperature: -30°C ... +55°C)	
Transport (EN 60721-3-2)			2K3 (temperature: -30 °C ... +75 °C)	
Insulation voltage to reference earth/PE				
EN 61800-5-1	U _{AC}	[V]	50.0	



Communication module: CANopen

Technical data

Product key			
Communication module			E84DGFCC□NP E84DGFCC□JP
Communication			
Medium			DIN ISO 11898
Communication profile			CANopen, DS301 V4.02 Lenze system bus
Baud rate			
	b	[kBit/s]	20 50 125 250 500 800 1000
Node			
			Slave Multi-master
Network topology			
			Line with terminating resistors (120 ohm) at both ends
Number of logical process data channels			
			2 "send" PDOs and 2 "receive" PDOs (each with 1 - 8 bytes)
Number of logic parameter data channels			
			Max. 2 server SDO channels (with 1 - 8 bytes)
Number of bus nodes			
			63
Max. cable length			
per bus segment	l_{max}	[m]	17 for 1000 kbps 40 for 800 kbps 110 for 500 kbps 290 for 250 kbps 630 for 125 kbps 1500 for 50 kbps 3900 for 20 kbps 8000 for 10 kbps
Rated voltage			
DC	$U_{N,DC}$	[V]	24.0

4.2

Pin assignment

Can be quickly connected to the bus and certain inputs/outputs via 5-pin M12 connector of the Communication Unit.

The connector is A-coded and can be connected using a 5-pole connection M12.

Mode	Variant	Product key	Slot							
			A1	A2	A3	A4	B1	B2	B3	B4
CANopen	I/O terminal	E84DGFCCANP								
	I/O 2xM12	E84DGFCC9NP	DI1 DI2	CAN-in	CAN-out	DI3 DI4				
CANopen STO	I/O terminal	E84DGFCCAJP								
	I/O 2xM12	E84DGFCC9JP	DI1 DI2			DI3 DI4				

► DI1 to DI4= digital inputs

Inverter Drives 8400 motec

Modules



EtherCAT® communication module

With the EtherCAT® communication module, the Inverter Drives 8400 motec supports end-to-end communication from the field level right through to company management level.



The benefits of this system include:

- Fieldbus system capable of handling large data volumes
- Use of IT standards
- Integrated switch allows direct looping of EtherCAT via the inverters
- Integrated I/O node. Capable of communication and reading inputs even when the 400V supply is switched off.
- Option to connect an external 24V supply



EtherCAT® communication module

4.2

Mode		Features	Number of free slots	Product key
Communication module				
EtherCAT		<ul style="list-style-type: none"> • Support for the "Distributed clocks" (DC) functionality for synchronisation via fieldbus • Link / Activity • PDO transfer with CoE (CANopen over EtherCAT) • Cycle times: 1 ms or a whole multiple of 1 ms; maximum 15 ms when using "distributed clocks" (DC) • 4 LEDs for status display • Controller enable • 5 digital inputs • 1 digital output 	5	E84DGFCT□NP
EtherCAT STO		<ul style="list-style-type: none"> • Support for the "Distributed clocks" (DC) functionality for synchronisation via fieldbus • Link / Activity • PDO transfer with CoE (CANopen over EtherCAT) • Cycle times: 1 ms or a whole multiple of 1 ms; maximum 15 ms when using "distributed clocks" (DC) • 4 LEDs for status display • Controller enable • 5 digital inputs • 1 digital output • 1 analog input • 1 relay • Safety function STO 	5	E84DGFCT□JP

Standards and operating conditions

Product key			E84DGFCT□NP	E84DGFCT□JP
Mode			EtherCAT	EtherCAT STO
Communication module				
Degree of protection			IP65	
EN 60529				
Climatic conditions				
Storage (EN 60721-3-1)			1K3 (temperature: -30 °C ... +60 °C)	
Operation (EN 60721-3-3)			3K3 (temperature: -30°C ... +55°C)	
Transport (EN 60721-3-2)			2K3 (temperature: -30 °C ... +75 °C)	
Insulation voltage to reference earth/PE				
EN 61800-5-1	U_{AC}	[V]	50.0	



EtherCAT® communication module

Technical data

Product key			E84DGFCT□NP	E84DGFCT□JP
Communication module				
Communication				
Medium			CAT5e S/FTP according to ISO/ICE11801 (2002)	
Communication profile			CoE (CANopen over EtherCAT)	
Baud rate				
	b	[MBit/s]	100	
Node				
			Slave	
Network topology				
			Line Switch	
Number of logical process data channels				
			1	
Process data words (PZD)				
to the master			1 ... 10 (max. 20 bytes, 16 bits/word)	
from the master			1 ... 8 (max. 16 bytes, 16 bits/word)	
Parameter data				
Max. mailbox size for CoE transfer			[Byte]	128
Number of bus nodes				
			Max. 65535	
Max. cable length				
between two nodes			I_{max}	[m] 100
Rated voltage				
DC			$U_{N,DC}$	[V] 24.0

4.2

Pin assignment

Can be quickly connected to the bus and certain inputs/outputs via 5-pin M12 connector of the Communication Unit.

The connector is A-coded and can be connected using a 5-pole connection M12.

Mode	Variant	Product key	Slot								
			A1	A2	A3	A4	B1	B2	B3	B4	
EtherCAT	I/O terminal	E84DGFCTANP	LED	EC-in	EC-out		DI1 DI2				
	I/O 1xM12	E84DGFCT9NP									
EtherCAT STO	I/O terminal	E84DGFCTAJP									
	I/O 1xM12	E84DGFCT9JP									

- ▶ DI1 to DI4= digital inputs
- ▶ LED= status display for bus communication

Inverter Drives 8400 motec



Modules

EtherNet/IP communication module



The EtherNet/IP communication module based on standard TCP and UDP enables the Inverter Drives 8400 motec to support a continuous communication from the field level right through to the controlling system.

The benefits of this system include:

- Currently widespread fieldbus based on real-time Ethernet
- Supports DHCP and BootP in allocating the IP address
- Devices linked via EtherNet/IP can be implemented seamlessly and with minimum configuration expense via mapping into the I/O tree of the RSLogix programming tool



EtherNet/IP communication module

Mode		Features	Number of free slots	Product key
Communication module				
EtherNet/IP		<ul style="list-style-type: none"> • Supports multicast messages, UCMM, ACD, BOOTP/DHCP, VLAN-Tagging/DSCP • Internal 24 V DC supply • 4 LEDs for status display • Controller enable • 5 digital inputs • 1 digital output 	5	E84DGFCG□NP
EtherNet/IP STO		<ul style="list-style-type: none"> • Supports multicast messages, UCMM, ACD, BOOTP/DHCP, VLAN-Tagging/DSCP • Internal 24 V DC supply • 4 LEDs for status display • Controller enable • 5 digital inputs • 1 digital output • 1 analog input • 1 relay • Safety function STO 	5	E84DGFCG□JP

4.2

Standards and operating conditions

Product key			E84DGFCG□NP	E84DGFCG□JP
Mode			EtherNet/IP	EtherNet/IP STO
Degree of protection			IP65	
EN 60529				
Climatic conditions				
Storage (EN 60721-3-1)			1K3 (temperature: -25 °C ... +60 °C)	
Operation (EN 60721-3-3)			3K3 (temperature: -10°C ... +55°C)	
Transport (EN 60721-3-2)			2K3 (temperature: -25 °C ... +70 °C)	
Insulation voltage to reference earth/PE				
EN 61800-5-1	U_{AC}	[V]	50.0	



EtherNet/IP communication module

Technical data

Product key			
Communication module			E84DGFCG□NP E84DGFCG□JP
Communication			
Medium			CAT5e S/FTP according to ISO/ICE11801 / EN50173
Communication profile			EtherNET/IP, AC Drive
Baud rate			
	b	[MBit/s]	10/100 (full duplex/half duplex)
Node			
			Slave (Adapter)
Network topology			
			Tree, star and line
Process data words (PZD)			
16 Bit			1 ... 16
Number of bus nodes			
			max. 254 im Subnetz
Max. cable length			
between two nodes	I_{max}	[m]	100
Rated voltage			
DC	$U_{N,DC}$	[V]	24.0

4.2

Pin assignment

Can be quickly connected to the bus and certain inputs/outputs via 5-pin M12 connector of the Communication Unit.

The connector is D-coded and can be connected using a 5-pole M12 connection.

Mode	Variant	Product key	Slot							
Communication module	Communication module		A1	A2	A3	A4	B1	B2	B3	B4
EtherNet/IP	I/O terminal	E84DGFCGANP	LED	EN-in	EN-out	DI1 DI2				
		E84DGFCG9NP								
EtherNet/IP STO	I/O 1xM12	E84DGFCGAJP								
		E84DGFCG9JP				DI1 DI2				

- ▶ DI1 to DI4= digital inputs
- ▶ LED= status display for bus communication

Inverter Drives 8400 motec

Modules



PROFIBUS communication modules

When combined with the PROFIBUS communication module, the 8400 motec supports PROFIBUS, the most widely used fieldbus system today.



The advantages of this system are:

- Widely used and extremely powerful fieldbus system
- Integrated I/O node. Capable of communication and reading inputs even when the 400 V supply is switched off.
- Option of connecting an external 24V supply



PROFIBUS communication modules

4.2

Mode		Features	Number of free slots	Product key
Communication module				
PROFIBUS		<ul style="list-style-type: none"> • DPVO: basic functionalities such as cyclical data exchange and diagnostics • DPV1: supports acyclical data exchange for parameter setting, operation and alarm handling • Internal 24 V DC supply • 4 LEDs for status display • Controller enable • 5 digital inputs • 1 digital output 	5	E84DGFCP□NP
PROFIBUS STO		<ul style="list-style-type: none"> • DPVO: basic functionalities such as cyclical data exchange and diagnostics • DPV1: supports acyclical data exchange for parameter setting, operation and alarm handling • Internal 24 V DC supply • 4 LEDs for status display • Controller enable • 5 digital inputs • 1 digital output • 1 analog input • 1 relay • Safety function STO 	5	E84DGFCP□JP

Standards and operating conditions

Product key			E84DGFCP□NP	E84DGFCP□JP
Mode			PROFIBUS	PROFIBUS STO
Degree of protection			IP65	
EN 60529				
Climatic conditions				
Storage (EN 60721-3-1)			1K3 (temperature: -30 °C ... +60 °C)	
Operation (EN 60721-3-3)			3K3 (temperature: -30°C ... +55°C)	
Transport (EN 60721-3-2)			2K3 (temperature: -30 °C ... +75 °C)	
Insulation voltage to reference earth/PE				
EN 61800-5-1	U_{AC}	[V]	50.0	



PROFIBUS communication modules

Technical data

Product key				
Communication module			E84DGFCP□NP	E84DGFCP□JP
Communication				
Medium			RS 485	
Communication profile			PROFIBUS-DP-V0 (DRIVECOM) PROFIBUS-DP-V1 (PROFIdrive)	
Baud rate				
	b	[kBit/s]	9.6 ... 12 000 (automatic detection)	
Node				
			Slave	
Network topology				
			with repeater: line or tree without repeater: line	
Process data words (PZD)				
16 Bit			1 ... 8	
DP user data length				
			Optional parameter channel (4 words) + process data words Acyclic parameter data channel (DP-V1): max 240 bytes	
Number of bus nodes				
			31 slaves + 1 master per bus segment With repeaters: 125	
Max. cable length				
per bus segment	I_{max}	[m]	1200 (depending on the baud rate and the cable type used)	
Rated voltage				
DC	$U_{N,DC}$	[V]	24.0	

4.2

Pin assignment

Can be quickly connected to the bus and certain inputs/outputs via 5-pin M12 connector of the Communication Unit.

The connector is B-coded and can be connected using a 5-pole connection M12.

Mode	Variant	Product key	Slot									
			A1	A2	A3	A4	B1	B2	B3	B4		
PROFIBUS	I/O terminal	E84DGFCPANP	LED	PB-in	PB-out							
	I/O 1xM12	E84DGFCP9NP				DI1 DI2						
PROFIBUS STO	I/O terminal	E84DGFCPAJP										
	I/O 1xM12	E84DGFCP9JP				DI1 DI2						

- ▶ DI1 to DI4= digital inputs
- ▶ LED= status display for bus communication



PROFINET communication modules



With the PROFINET communication module, the 8400 motec supports a fieldbus system for continuous communication from the field level right through to company management level.

The benefits of this system include:

- Fieldbus system capable of handling large data volumes
- Use of IT standards
- Integrated switch allows direct looping of PROFINET via the inverters
- Integrated I/O node. Capable of communication and reading inputs even when the 400 V supply is switched off.
- Option to connect an external 24 V supply



PROFINET communication modules

Mode		Features	Number of free slots	Product key
Communication module				
PROFINET		<ul style="list-style-type: none"> • Automatic detection of the 100 Mbps baud rate • Creation of a line topology through integrated 2-port switch • Support for I&M 0 to 4 functionality for identification of the standard device • Link / Activity • 4 LEDs for status display • Controller enable • 5 digital inputs • 1 digital output 	5	E84DGFCR□NP
PROFINET STO		<ul style="list-style-type: none"> • Automatic detection of the 100 Mbps baud rate • Creation of a line topology through integrated 2-port switch • Support for I&M 0 to 4 functionality for identification of the standard device • Link / Activity • 4 LEDs for status display • Controller enable • 5 digital inputs • 1 digital output • 1 analog input • 1 relay • Safety function STO 	5	E84DGFCR□JP

Standards and operating conditions

Product key			E84DGFCR□NP	E84DGFCR□JP
Mode			PROFINET	PROFINET STO
Communication module				
Degree of protection			IP65	
EN 60529				
Climatic conditions				
Storage (EN 60721-3-1)			1K3 (temperature: -30 °C ... +60 °C)	
Operation (EN 60721-3-3)			3K3 (temperature: -30°C ... +55°C)	
Transport (EN 60721-3-2)			2K3 (temperature: -30 °C ... +75 °C)	
Insulation voltage to reference earth/PE				
EN 61800-5-1	U_{AC}	[V]	50.0	



PROFINET communication modules

Technical data

Product key			
Communication module			E84DGFCR□NP E84DGFCR□JP
Communication			
Medium			CAT5e S/FTP according to ISO/ICE11801 (2002)
Communication profile			PROFINET RT Conf. Class B
Baud rate			
	b	[MBit/s]	100
Node			
			Slave (Device)
Network topology			
			Tree, star and line
Number of logical process data channels			
			1
Process data words (PZD)			
16 Bit			1 ... 8
Max. cable length			
between two nodes	I_{max}	[m]	100
Rated voltage			
DC	$U_{N,DC}$	[V]	24.0

4.2

Pin assignment

Can be quickly connected to the bus and certain inputs/outputs via 5-pin M12 connector of the Communication Unit.

The connector is D-coded and can be connected using a 5-pole M12 connection.

Mode	Variant	Product key	Slot							
			A1	A2	A3	A4	B1	B2	B3	B4
PROFINET	I/O terminal	E84DGFCRANP	LED	PN-in	PN-out					
	I/O 1xM12	E84DGFCR9NP				DI1 DI2				
PROFINET STO	I/O terminal	E84DGFCRAJP								
	I/O 1xM12	E84DGFCR9JP				DI1 DI2				

- ▶ DI1 to DI4= digital inputs
- ▶ LED= status display for bus communication

Inverter Drives 8400 motec

Modules



Inverter Drives 8400 motec

Accessories



Wiring Unit versions

The wiring unit forms the interface between the various motor frame sizes and inverters. In addition to this, it provides the flexibility in terms of connection options for power, motor, brake and brake resistance. The correct wiring unit is selected based on the size of the motor and the terminal box.

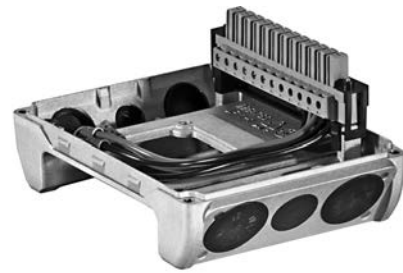

Wiring Unit

Product key	E84DGVN1E	E84DGVN2E	E84DGVN3E	E84DGVN4E	E84DGVN5E
Mode	Wiring Unit				
Features	<ul style="list-style-type: none"> For E84DVB□3714 to 1124 For motor frame sizes 063 and 071 Enclosure: IP66 	<ul style="list-style-type: none"> For E84DVB□5514 to 1524 For motor frame sizes 080, 090 and 100 Enclosure: IP66 	<ul style="list-style-type: none"> For E84DVB□2224 to 3024 For motor frame sizes 080, 090 100 and 112 Enclosure: IP66 	<ul style="list-style-type: none"> For E84DVB□4024 to 7524 For motor frame sizes 080, 090 100 and 112 Enclosure: IP66 	<ul style="list-style-type: none"> For E84DVB□5524 to 7524 For motor frame size 132 Enclosure: IP66

4.2

Connector modules

Screwed sockets for the mains connection are included on the Inverter Drives 8400 motec as standard. Alternatively, Q4, Q5 or Q8 plug-in modules can be used. Thanks to the universal connection options offered by the modules, a supply bus can be set up using plugs and couplings without the need for any external accessories.

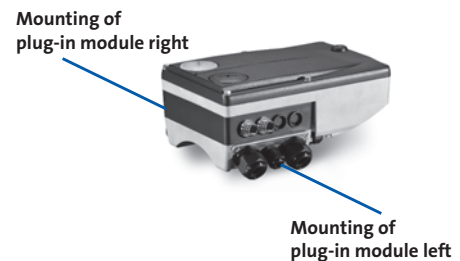







HAN connector

Mode		Features	Product key
Plug-in module 1 x Q5/0, left		<ul style="list-style-type: none"> 5 power contacts and PE: 16 A/400 V Applications with external mains distributor 	E84DZEVBANP
Plug-in module 1 x Q5/0, right			E84DZEVBANP



HAN connector

Mode		Features	Product key
Plug-in module 2 x Q5/0, left		<ul style="list-style-type: none"> • 5 power contacts and PE: 16 A/400 V • Applications with mains loops 	E84DZEVBALFP
Plug-in module 2 x Q5/0, right			E84DZEVBRAFP
Plug-in module 1 x Q4/2, left		<ul style="list-style-type: none"> • 4 power contacts and PE: 32 A/400 V • 2 control contacts: 10 A/24 V • Applications with external mains distributor 	E84DZEVBLPNP
Plug-in module 1 x Q4/2, right			E84DZEVBRPNP
Plug-in module 2 x Q4/2, left		<ul style="list-style-type: none"> • 4 power contacts and PE: 32 A/400 V • 2 control contacts: 10 A/24 V • Applications with mains loops 	E84DZEVBLPRP
Plug-in module 2 x Q4/2, right			E84DZEVBRPRP
Plug-in module 1 x Q8/0, left		<ul style="list-style-type: none"> • 6 power contacts and PE: 25 A/400 V • Motor connection with wall mounting 	E84DZEVBLGNP
Plug-in module 1 x Q8/0, right			E84DZEVBRGNP

Inverter Drives 8400 motec

Accessories



Internal brake resistor

An internal brake resistor can also be mounted on the **right-hand** side of the 8400 motec instead of the plug-in modules.



Internal brake resistor

Typical motor power	Mains voltage	Product key		Rated resistance	Rated power	Thermal capacity
		Inverter	Brake resistor			
4-pole asynchronous motor						
P	U_{AC}			R_N	P_N	C_{th}
[kW]	[V]			[Ω]	[kW]	[KWs]
0.37	3 AC 320 ... 528	E84DVB□3714S□□□2□	E84DZEW220R	220.0	15.0	0.28
0.55		E84DVB□5514S□□□2□				
0.75		E84DVB□7514S□□□2□				
1.10		E84DVB□1124S□□□2□				
1.50		E84DVB□1524S□□□2□				
2.20		E84DVB□2224S□□□2□	E84DZEW100R	100.0		
3.00		E84DVB□3024S□□□2□				
4.00		E84DVB□4024S□□□2□				
5.50		E84DVB□5524S□□□2□	E84DZEW047R	47.0		
7.50		E84DVB□7524S□□□2□				

4.2

Wall mounting

The wall mount is used to attached is the inverter to be machine chassis or the wall. The design offers IP65 protection and is easy to attach.



Wall mounting

Product key	E84DZMAWE1
Mode	Wall mounting
Features	<ul style="list-style-type: none"> • Degree of protection IP65 • Ease of installation



Brake resistors

An external brake resistor is required to brake high moments of inertia or in the event of prolonged operation in generator mode; this resistor converts braking energy into heat.

The brake resistors recommended in the table below have been dimensioned for approx. 1.5 times the regenerative power, with a cycle time of 15/135 s (brake/rest ratio). These brake resistors generally meet the usual requirements of standard applications.

The brake resistors are fitted with a thermostat (potential-free NC contact).



Brake resistor

Typical motor power	Mains voltage	Product key		Rated resistance	Rated power	Thermal capacity	Dimensions	Mass
		Inverter	Brake resistor					
4-pole asynchronous motor								
P	U_{AC}			R_N	P_N	C_{th}	$h \times b \times t$	m
[kW]	[V]			[Ω]	[kW]	[KW s]	[mm]	[kg]
0.37	3 AC 320... 528	E84DVB□3714S□□□2□	ERBS180R350W	180.0	350.0	53.0	382 x 124 x 122	2.0
0.55		E84DVB□5514S□□□2□						
0.75		E84DVB□7514S□□□2□						
1.10		E84DVB□1124S□□□2□						
1.50		E84DVB□1524S□□□2□						
2.20		E84DVB□2224S□□□2□	ERBS100R625W	100.0	625.0	94.0	566 x 124 x 122	3.0
3.00		E84DVB□3024S□□□2□						
4.00		E84DVB□4024S□□□2□						
5.50		E84DVB□5524S□□□2□	ERBS047R400W ERBS047R800W	47.0	400.0 800.0	60.0 120	400 x 110 x 105 710 x 110 x 105	2.3 3.9
7.50		E84DVB□7524S□□□2□						

Inverter Drives 8400 motec



Accessories

USB diagnostic adapter

The operation, parameter setting and diagnostics of the Inverter Drives 8400 and the Servo Drives 9400 via the L-force diagnostics is made with the keypad X400 or a PC. The connection of a PC can be made via a USB interface and the USB diagnostic adapter.

For connecting the USB diagnostic adapter with the L-force diagnostics interface (DIAG) at the inverter, three different connecting cables are separately available in the lengths 2.5 m, 5 m and 10 m. The connection can be established during operation. The engineering tools EASY Starter or Engineer can be used to carry out the operation, parameter setting or diagnostics of the inverters. Both tools have simple intuitive surfaces. This enables a quick and easy commissioning.

Optionally to the USB diagnostic adapter, the PC system bus adapter can be used. For this purpose, a CANopen interface must be available at the inverter.



USB diagnostic adapter incl. connecting cable to the PC

4.2

- The engineering tools EASY Starter or Engineer are used for operation, parameter setting and diagnostics of the inverters.

Mode		Features	Product key
USB diagnostic adapter		<ul style="list-style-type: none"> • Input-side voltage supply via USB connection on PC • Output-side voltage supply via inverter's diagnostic interface • Diagnostic LEDs • Electrical isolation of PC and inverter • Hot-pluggable 	E94AZCUS

Connecting cables for USB diagnostic adapter

Mode	Features	Product key
Connecting cable for USB diagnostic adapter	• Length: 2.5 m	EWL0070
	• Length: 5 m	EWL0071
	• Length: 10 m	EWL0072

Inverter Drives 8400 motec

Accessories



Diagnosis terminal

The diagnosis terminal can be used as an alternative to a PC if you are looking for an easy way to operate the inverter, set parameters or carry out diagnostics locally. The structured menus and plain text display provide quick access to data.

The diagnosis terminal can be plugged into the inverter's L-force diagnostic interface (DIAG) from the outside.



Diagnosis terminal

4.2

Mode	Features	Slot	Product key
Diagnosis terminal	<ul style="list-style-type: none">• Diagnosis terminal inside robust housing• incl. 2.5 m cable• Degree of protection IP20• For 8400 motec and protec.	DIAG	EZAEBK2003

Switch/potentiometer unit

The switch / potentiometer unit is fitted directly to the 8400 motec or in a different position within the system. An analogue setpoint can be specified with the switch/potentiometer unit and the control connections integrated in the inverter by using the integrated potentiometer; the rotary switch can, for example, be used to start/stop the drive or change the direction of rotation. The switch/potentiometer unit is supplied with a 2.5 m connection cable.



Switch/potentiometer unit

Mode	Product key
Switch/potentiometer unit (IP65)	E82ZBU



System cables

For connection of the motor, Lenze provides finished hybrid cables. They are optimally matched to the connection between the Drive Package components. Motor connection, blower connection, brake connection and temperature monitoring are integrated in the cables. Cables up to a length of 100 m can be selected in increments of 0.1 m.

10-pole cables

Available with cross-sections 1.5² and 2.5² with connection for brake or thermal contact.

Product series	Cable type	Connection cable	Cable length in decimetres	Cable end on the motor side (socket)	Cable end on the controller side
E Y P Motor		A	0 0 0 3 5 0 0 0 Minimum length Maximum length		
Fixed installation	0 0 3 9	1.5 mm ²		H 0 7 Modular 16A	A 0 0 Without plug-in connector Q 0 8 Modular 40A
	0 0 4 0	2.5 mm ²		A 0 0 Without plug-in connector	Q 0 8 Modular 40A
	0 0 4 6	4.0 mm ²		H 0 8 Modular 16A	A 0 0 Without plug-in connector Q 0 9 Modular 40A
	0 0 4 7	10.0 mm ²		H 0 9 Modular 40A	A 0 0 Without plug-in connector Q 0 9 Modular 40A
				A 0 0 Without plug-in connector	Q 0 9 Modular 40A
				H 1 4 Modular 40A	A 0 0 Without plug-in connector
				H 1 5 Modular 40A	A 0 0 Without plug-in connector



8-pole cables

Available with cross-sections 1.5² and 2.5² with connection for brake and thermal contact.

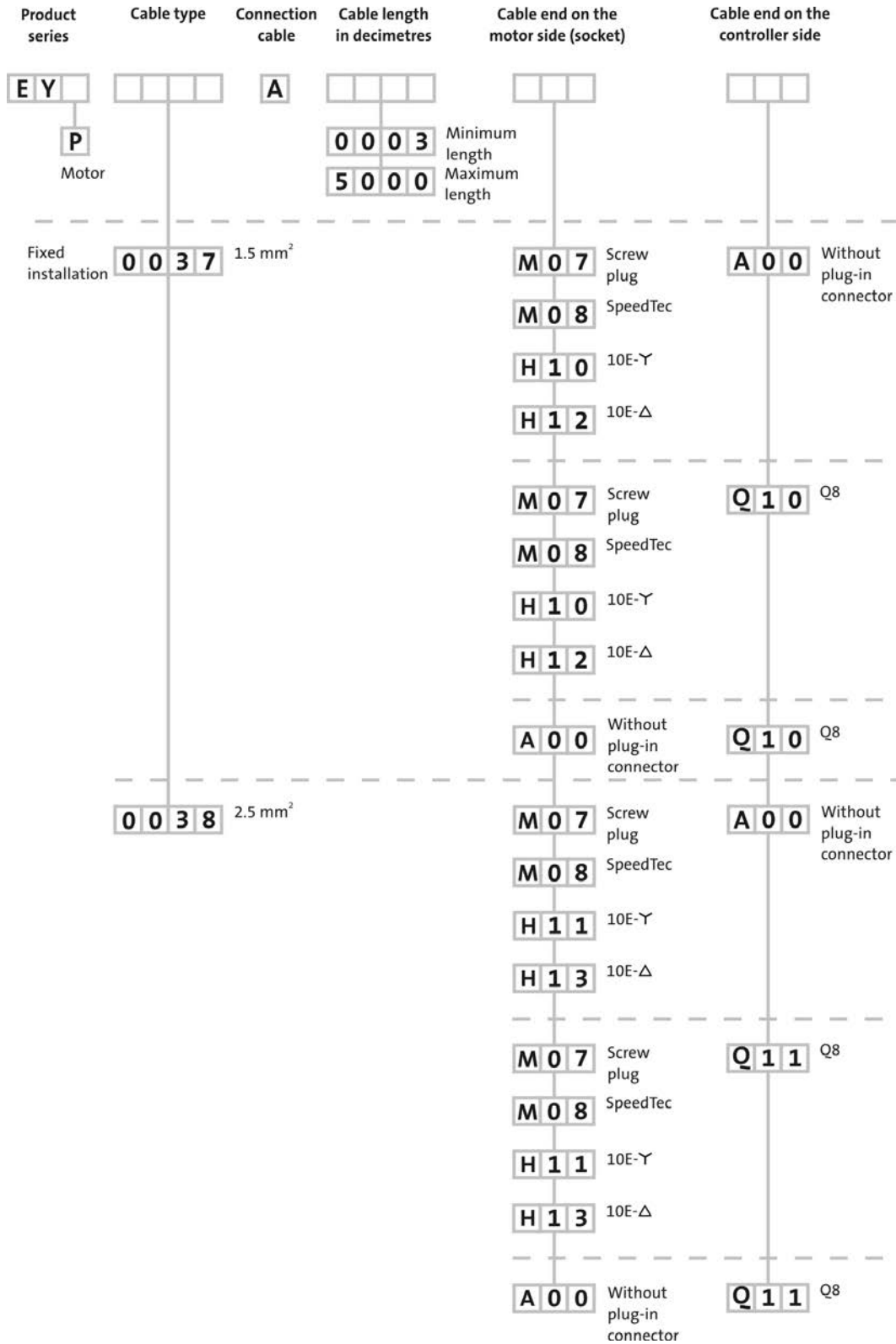

4.2

Inverter Drives 8400 motec

Accessories



Inverter Drives 8400 motec

Accessories



15593801

Lenze SE
Hans-Lenze-Straße 1
D-31855 Aerzen
Phone: +49 (0)5154 82-0
Telefax: +49 (0)5154 82 28 00

www.Lenze.com

Lenze