



SEW
EURODRIVE



Synchronous Servomotors CMP40/50/63/71/80/100

Edition 01/2009

11659416 / EN

Operating Instructions

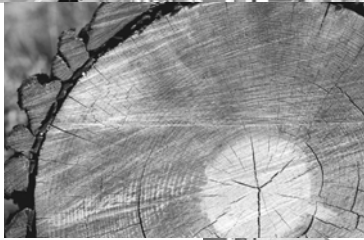



1	General Information	5
1.1	How to use the operating instructions	5
1.2	Structure of the safety notes	5
1.3	Rights to claim under limited warranty	6
1.4	Exclusion of liability	6
2	Safety Notes	7
2.1	General information	7
2.2	Target group	8
2.3	Designated use	8
2.4	Transportation/storage	9
2.5	Mounting/installation	9
2.6	Electrical connection	10
2.7	Startup/operation	10
2.8	Inspection/maintenance	10
2.9	Disposal	10
3	Scope of Delivery and Unit Design	11
3.1	Nameplate and unit designation	11
3.1.1	Nameplate on the servomotor	11
3.1.2	Servomotor unit designation	12
3.1.3	Nameplate on the servo gearmotor	13
3.1.4	Serial number	13
3.2	Structure of the synchronous CMP servomotor	14
4	Mechanical Installation	16
4.1	Required tools/resources	16
4.2	Before you start.....	16
4.3	Preliminary work.....	16
4.3.1	Long-term storage of servomotors	16
4.3.2	Insulation resistance too low	17
4.4	Installing the motor.....	18
4.5	Installation tolerances	19
5	Electrical Installation	20
5.1	Connector installation	20
5.2	Wiring information	22
5.2.1	Protecting the brake control system against interference	22
5.2.2	Thermal motor protection	22
5.3	Connecting motor and encoders system via SM./SB. plug connectors	23
5.3.1	Plug connector on the cable end	23
5.3.2	Feedback and forced cooling fan cable	26
5.3.3	Prefabricated cables	26
5.3.4	Wiring diagrams for synchronous CMP servomotors	27
5.4	Assembly of plug connectors for resolver/HIPERFACE®.....	30
5.4.1	Scope of delivery signal plug connectors	30
5.4.2	Assembly notes for signal plug connectors	31
5.5	Power connector assembly.....	33
5.5.1	Scope of delivery of SM. / SB. power plug connectors	33
5.5.2	Assembly notes for SM1 / SB1 power connectors	34
5.5.3	Assembly notes for SMB. / SBB. power connectors	36
5.6	Thermal motor protection	38
5.7	VR forced cooling fan.....	39
5.8	Connecting the brake	41



6	Startup	42
6.1	Prerequisites for startup	42
7	Malfunctions	43
7.1	Malfunctions of the servomotor	43
7.2	Malfunctions of the servo inverter	43
7.3	Malfunctions of the brake	44
8	Inspection/Maintenance	45
8.1	Inspection intervals	46
9	Technical Data	47
9.1	Key to the data tables	47
9.2	Technical data – Synchronous CMP servomotors	48
9.3	Technical data – Synchronous CMP./BP servo brakemotors	49
9.4	Technical data of the BP brake	50
10	Index	55



1 General Information

1.1 How to use the operating instructions

Operating instructions are an integral part of the product and contain important information for operation and service. They are intended for staff responsible for the assembly, installation, startup and maintenance of the product.

The operating instructions must be legible and accessible at all times. Make sure that staff responsible for the plant and its operation, as well as persons who work independently on the unit, have read the operating instructions carefully and understood them. If you are unclear about any of the information in this documentation, or if you require further information, contact SEW-EURODRIVE.

1.2 Structure of the safety notes

The safety notes in these operating instructions are designed as follows:

Pictogram	! SIGNAL WORD
	Type and source of danger. Possible consequence(s) if the safety notes are disregarded. • Measure(s) to prevent the danger.

Pictogram	Signal word	Meaning	Consequences if disregarded
Example: 	! DANGER	Imminent danger	Severe or fatal injuries
General danger	! WARNING	Possible dangerous situation	Severe or fatal injuries
	! CAUTION	Possible dangerous situation	Minor injuries
Specific danger, e.g. electric shock	STOP	Possible damage to property	Damage to the drive system or its environment
	TIP	Useful information or tip. Simplifies the handling of the drive system.	

**1.3 Rights to claim under limited warranty**

A requirement of fault-free operation and fulfillment of any rights to claim under limited warranty is that you adhere to the information in the operating instructions. Therefore, read the operating instructions before you start working with the unit

1.4 Exclusion of liability



You must comply with the information contained in these operating instructions to ensure safe operation of the electric motors and to achieve the specified product characteristics and performance features. SEW-EURODRIVE assumes no liability for injury to persons or damage to equipment or property resulting from non-observance of these operating instructions. In such cases, any liability for defects is excluded.



2 Safety Notes

The following basic safety notes must be read carefully to prevent injury to persons and damage to property. The operator must make sure that the basic safety notes are read and observed. Make sure that persons responsible for the plant and its operation, as well as persons who work independently on the unit, have read through the operating instructions carefully and understood them. If you are unclear about any of the information in this documentation, or if you require further information, please contact SEW-EURODRIVE.

2.1 General information

	 DANGER
	<p>Servomotors, gearmotors and gear units may have live, uninsulated (in case of open connector/terminal boxes), and sometimes moving or rotating parts as well as hot surfaces during operation.</p> <p>Severe or fatal injuries.</p> <ul style="list-style-type: none"> • All work related to transportation, storage, setup/mounting, connection, startup, maintenance and repair may only be carried out by qualified personnel, in strict observation of: <ul style="list-style-type: none"> – The relevant detailed operating instructions – Warning and safety signs on the motor/gearmotor – All other project planning documents, operating instructions and wiring diagrams belonging to the drive – The specific regulations and requirements for the system – National / regional regulations governing safety and the prevention of accidents • Never install damaged products • Immediately report any damages to the shipping company

Removing the required protection cover or the housing without authorization, improper use as well as incorrect installation or operation may result in severe injuries to persons or damage to property.

Refer to the documentation for additional information.



2.2 Target group

Any mechanical work may only be performed by adequately qualified personnel. Qualified personnel in this context are persons who are familiar with the setup, mechanical installation, trouble shooting and maintenance for this product. Further, they are qualified as follows:

- Completed apprenticeship in the field of mechanical engineering (e.g. mechanic or mechatronic technician).
- They are familiar with these operating instructions.

Any electric work may only be performed by adequately qualified personnel. Qualified electricians in this context are persons who are familiar with the electronic installation, startup, trouble shooting and maintenance for this product. Further, they are qualified as follows:

- Completed apprenticeship in the field of electrical engineering (e.g. electric or mechatronic technician).
- They are familiar with these operating instructions.

All persons involved in any other work, such as transportation, storage, operation and disposal, must be trained appropriately.

2.3 Designated use

The designated use refers to the procedure specified in the operating instructions.

CMP synchronous servomotors are drive motors designed for use in industrial and commercial systems. Motor loads other than those specified and areas of application other than industrial and commercial systems should only be used after consultation with SEW-EURODRIVE.

The CMP synchronous servomotors meet the requirements of the low voltage directive 2006/95/EC. Do not take the unit into operation until you have established that the end product complies with the EC Machinery Directive 98/37/EC.

You must observe the technical data and information on the connection requirements as provided on the nameplate and in the documentation.



2.4 Transportation/storage

Follow the instructions on transportation, storage and proper handling. Observe the climate conditions according to chapter "General technical data".

Inspect the shipment for any damage that may have occurred in transit as soon as you receive the delivery. Inform the shipping company immediately. If you notice any transport damage, do not startup the motor, but contact the SEW-EURODRIVE Service.

Remove securing devices used for transportation prior to startup.

Tighten installed transportation eyebolts. They are designed to only carry the weight of the motor/gearmotor; do not attach any additional loads.

The installed lifting eyebolts comply with DIN 580. The loads and regulations specified in this standard must always be observed. If the gearmotor has 2 suspension eye lugs or lifting eyebolts, then you should also use both suspension eye lugs for attaching transport ropes. In this case, the tension force vector of the slings must not exceed a 45° angle according to DIN 580.

	TIPS
	<ul style="list-style-type: none"> • Screw in the lifting eyes all the way. • Make sure that the lifting eyes carry only a reduced load, as the angle of the load exceeds 45°. • Due to the angle of the load, the lifting eyes are oversized. Note that the lifting eyes are not designed to hold the entire load of the gear unit.

Store the servomotor in a dry, dust-free environment if it is not to be installed straight away. The servomotor can be stored for one year without requiring any special measures before startup.

2.5 Mounting/installation

Observe the instructions in section 4, "Mechanical Installation" and section 5, "Electrical Installation".

The units must be installed and cooled according to the regulations and specifications in the corresponding documentation.

Protect the synchronous servomotors from excessive strain. Ensure that components are not deformed, particularly during transportation and handling.

The following applications are prohibited unless the unit is explicitly designed for such use:

- Use in potentially explosive atmospheres
- Use in areas exposed to harmful oils, acids, gases, vapors, dust, radiation, etc.



2.6 Electrical connection

Perform electrical installation according to the pertinent regulations (e.g. cable cross sections, fusing, protective conductor connection). For any additional information, refer to the applicable documentation.

Observe the wiring information and differing data on the nameplate.

Observe the instructions in section 5, "Electrical Installation".

2.7 Startup/operation

Whenever changes to normal operation occur, such as increased temperatures, noise, vibrations, determine the cause and consult the manufacturer.

Refer to the information in section 6, "Startup."

2.8 Inspection/maintenance

Comply with the instructions in section 8, "Inspection and Maintenance."

2.9 Disposal

This product consists of:

- Iron
- Aluminum
- Copper
- Plastic
- Electronic components

Dispose of all components in accordance with applicable regulations.



3 Scope of Delivery and Unit Design



For information on the delivery scope and project planning, refer to the "DR, CMP Motors" catalog as well as the relevant gear unit operating instructions.

3.1 Nameplate and unit designation

3.1.1 Nameplate on the servomotor

Example: Nameplate of synchronous servo brakemotor CMP40M / BP / KY / AK0H / SB1

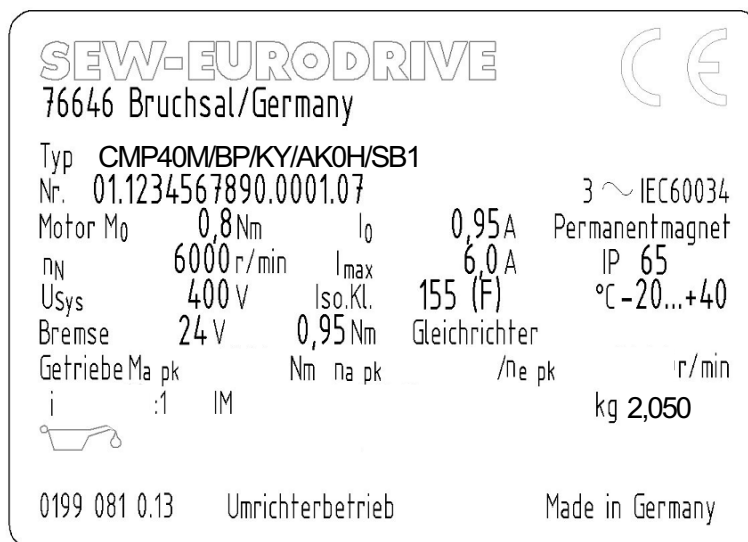

Figure 1: Nameplate on the CMP synchronous servo brake motor

63468ade

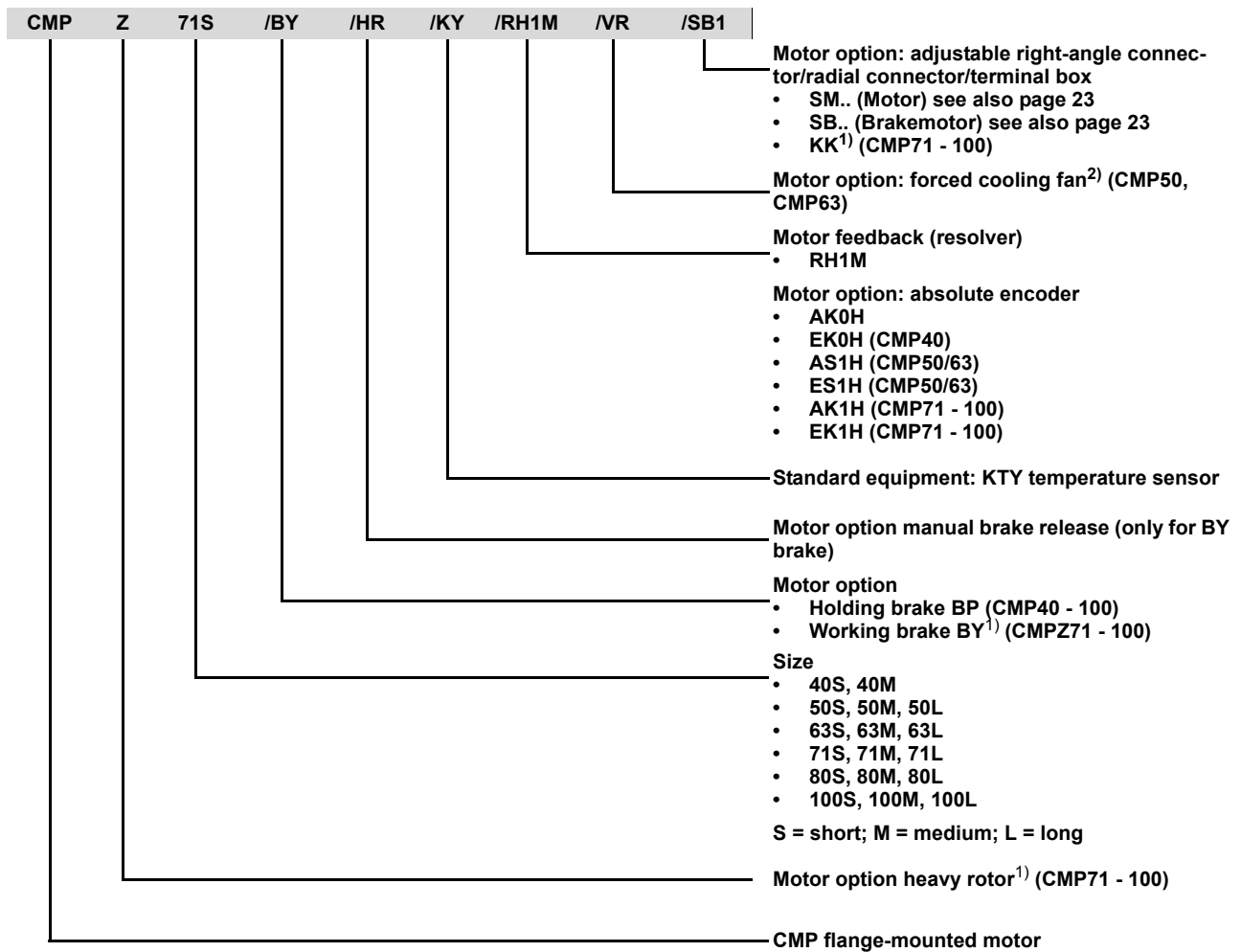

Figure 2: Location of the nameplate

58810axx



3.1.2 Servomotor unit designation



1) In preparation

2) In preparation for CMP71 - 100



3.1.3 Nameplate on the servo gearmotor

Example: Nameplate of synchronous servo gearmotor with brake PSC221 CMP40M / BP / AK0H / SB1

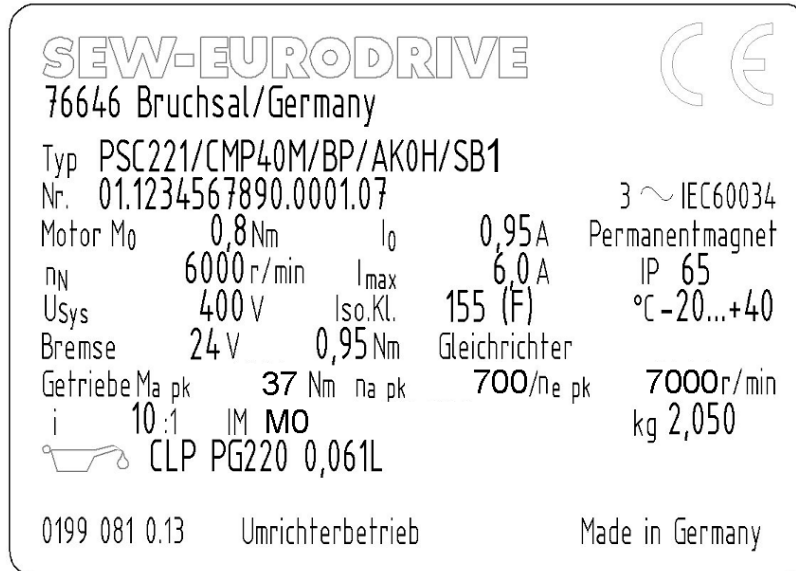
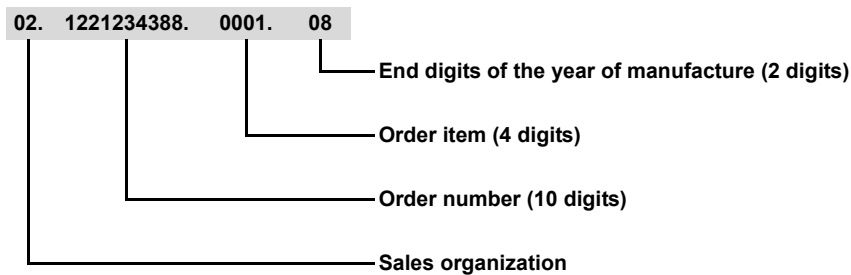

Figure 3: Nameplate of synchronous servo gearmotor with brake

62865ade

3.1.4 Serial number





3.2 Structure of the synchronous CMP servomotor

	<p>TIP</p> <p>The following illustrations are intended to explain the general structure of the unit. Differences are possible depending on the motor size and variant.</p>
---	---

CMP40 - CMP63

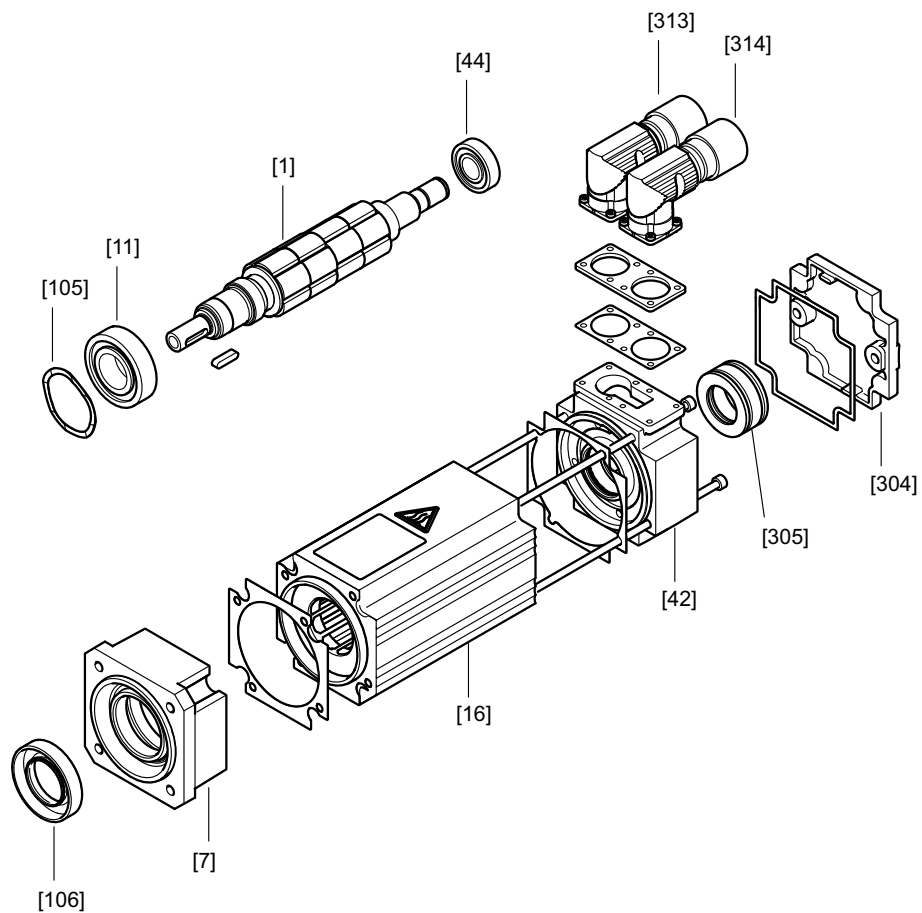

63231AXX

Figure 4: General structure of the synchronous servomotor CMP40 - 63

- [1] Rotor (key optional)
- [7] Flange
- [11] Grooved ball bearing
- [16] Brake endshield
- [42] Stator
- [44] Grooved ball bearing
- [105] Shim washer
- [106] Oil seal
- [304] Cover
- [305] Resolver
- [313] SM/SB signal plug connector
- [314] SM/SB power plug connector



CMP71 - CMP100

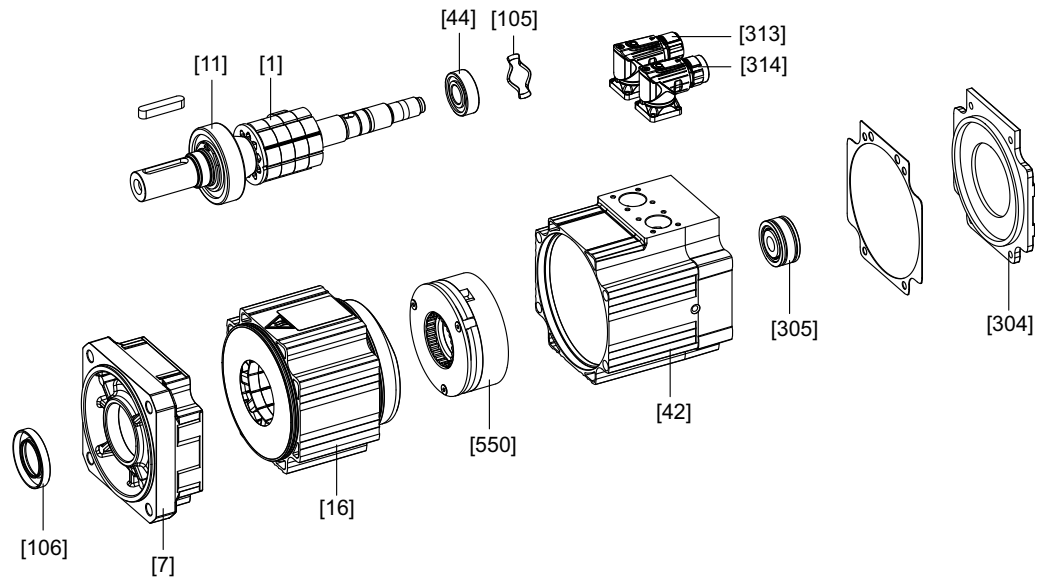

64024axx

Figure 5: General structure of the synchronous servomotor with brake CMP71 - 100

- [1] Rotor (key optional)
- [7] Flange
- [11] Grooved ball bearing
- [16] Brake endshield
- [42] Stator
- [44] Grooved ball bearing
- [105] Shim washer
- [106] Oil seal
- [304] Cover
- [305] Resolver
- [313] SB signal plug connector
- [314] SB power plug connector
- [550] BP holding brake



4 Mechanical Installation

4.1 Required tools/resources

- Standard tools
- For plug connectors assembled by the customer:
 - Crimping pliers up to 10 mm² cable cross section
 - Crimping pliers from 16 mm² cable cross section
- For delivery until 12/2008: Removal tool for insulator when changing the plug connector.
- For delivery as of 01/2009: No tool required for right-angle plug connector.

4.2 Before you start

Install the drive only if the following conditions are met:

- The drive must be undamaged (no damage caused by shipping or storage).
- The specifications on the nameplate of the drive correspond to the supply system or the output voltage of the servo inverter.
- The ambient temperature is between -20 °C and +40 °C.
- The installation altitude must be no higher than 1000 m above MSL, otherwise the drive must be designed to meet the special environmental conditions.
- The surrounding area is free from oils, acids, gases, vapors, radiation, etc.

4.3 Preliminary work

Motor shaft ends must be thoroughly cleaned of anti-corrosion agents, contamination or similar. Use a commercially available solvent. Make sure that the solvent does not come into contact with the bearing or sealing rings as it may damage the material.

	⚠ CAUTION
	<p>The bearing and the sealing rings can be damaged if exposed to solvents. Potential damage to property.</p> <ul style="list-style-type: none"> • Protect the bearing and sealing rings from exposure to solvents.

4.3.1 Long-term storage of servomotors

- The service life of the ball bearing grease is reduced after storage periods exceeding one year.
- Check whether the servomotor has absorbed moisture as a result of being stored for a long time. Measure the insulation resistance with a measurement voltage of DC 500 V.



The insulation resistance varies greatly depending on the temperature. You can measure the insulation resistance between the connection pins and the motor housing using an insulation measuring device. The motor must be dried if the insulation resistance is not sufficient.

The following figure shows the insulation resistance depending on the temperature.

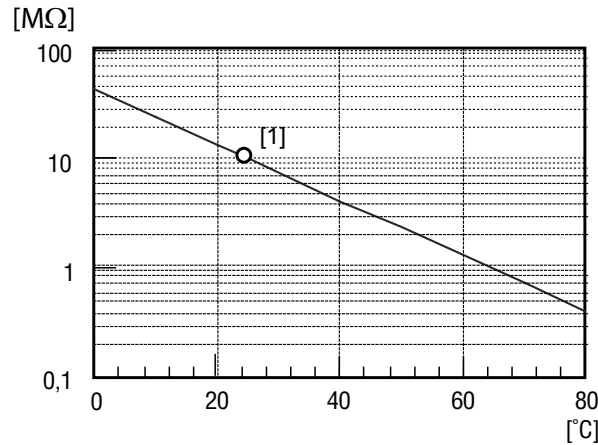

53725AXX

Figure 6: Insulation resistance depending on the temperature

[1] Resistance/temperature point (RT point)

4.3.2 Insulation resistance too low



TIP

Insulation resistance too low:

- Servomotor has absorbed moisture.

Measure: Send the servomotor to SEW-EURODRIVE Service with a description of the error.



4.4 Installing the motor

	⚠ CAUTION
	<p>Improper mounting may result in damages to the motor. Possible damage to property!</p> <ul style="list-style-type: none"> • Do only install the motor in the specified mounting position on a level, vibration-free and torsionally rigid support structure. • Align the motor and the driven machine carefully to avoid placing any unacceptable strain on the output shafts. • Observe the permitted overhung and axial loads, see the "DR, CMP Motors" catalog. • Do not jolt or hammer the shaft end.

	⚠ WARNING
	<p>The servomotor can have a surface temperature of more than 100 °C during operation. Risk of burns and fire.</p> <ul style="list-style-type: none"> • Never touch the CMP synchronous servomotor during operation or in the cool down phase once it has been switched off.

Aligning the motor shaft

Align the servomotor and the driven machine carefully to avoid placing any unacceptable strain on the output shaft. Observe the permitted overhung and axial loads, see the "DR, CMP Motors" catalog.

Do not jolt or hammer the shaft end.

Supply of cooling air

	⚠ CAUTION
	<p>Vertical designs with VR forced-cooling fan can get damaged by foreign objects or moisture. Possible damage to property!</p> <ul style="list-style-type: none"> • Protect vertical mounting positions with VR forced cooling fan by installing a cover.

If a forced cooling fan is used, ensure there is sufficient clearance around the unit to allow for adequate cooling. Make sure that it does not reuse the air warmed by other devices. Position the unit housing **at least 10 cm** away from the wall.



Installation in damp locations or in the open

- Try to arrange the motor and encoder connection so that the connector cables do not point upwards.
- Clean the sealing surfaces of the connector (motor or encoder connection) before re-assembly.
- Replace any brittle seals.
- If necessary, restore the anticorrosive paint coat.
- Check that the degree of protection is maintained.
- If necessary, attach covers (protection canopy).

4.5 Installation tolerances

Shaft end (CMP40 - 80)	Flanges (CMP40 - 80)
Diameter tolerance in accordance with DIN 748 <ul style="list-style-type: none"> • ISO k6 • Center bore to DIN 332 	Centering shoulder tolerance in accordance with EN 50347 <ul style="list-style-type: none"> • ISO j6



5 Electrical Installation

	DANGER
	<p>Danger of electric shock.</p> <p>Severe or fatal injuries!</p> <ul style="list-style-type: none"> • Observe the safety notes in section 2 during installation. • Use switch contacts in utilization category AC-3 to EN 60947-4-1 to connect the motor and brake. • Use switch contacts in utilization category DC-3 to EN 60947-4-1 for connecting the brake to DC 24 V. • When motors are powered from inverters, you must adhere to the wiring instructions issued by the inverter manufacturer. • Observe the operating instructions of the servo inverter.

	CAUTION
	<p>Use switch contacts in utilization category AC-3 to EN 60947-4-1 for connecting the servomotor and brake.</p> <p>Use switch contacts in utilization category DC-3 to EN 60947-4-1 for connecting the brake to DC 24 V.</p> <p>The wiring diagram is supplied in a bag attached to the motor.</p> <p>Observe the wiring instructions supplied by the manufacturer of the servo inverter for servomotors operated with servo inverters. It is essential to observe the operating instructions supplied with the servo inverter.</p>

	TIP
	<p>A bag containing the following information is attached to the motor:</p> <ul style="list-style-type: none"> • Safety notes • Wiring diagram <p>You must comply with this information.</p>

5.1 Connector installation

The cable entry of the power and signal cable is installed using an adjustable right-angle connector. Once the mating connector has been plugged in, the right-angle connector can be adjusted as required without using additional tools. A torque of > 8 Nm is required to adjust the connector.

	STOP
	<p>Possible damage of the right-angle connector in case of rotation without mating connector.</p> <p>Do not use pliers to adjust the right-angle connector before connecting it.</p> <p>Result:</p> <ul style="list-style-type: none"> • Destruction of the thread. • Leakage due to damaged sealing surface.



Connector positions

An "adjustable" position has been defined for right-angle, adjustable connectors [1]. This is the standard connector position. It corresponds to connector position "3".

A "radial" position has been defined for the straight plug connectors (radial output). Radial plug connectors [2] are optional.

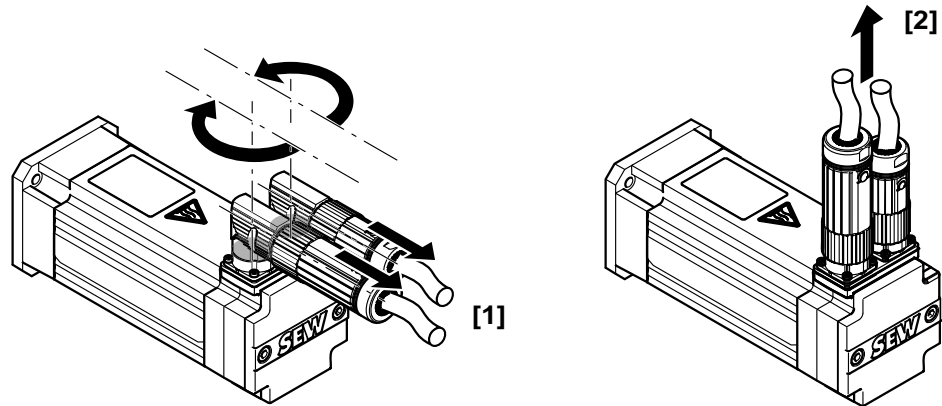

63831axx

Figure 7: Connector positions

[1] Connector position "adjustable"

[2] Connector position "radial"

	TIP
	<p>Comply with the permitted bending radii of the cables.</p> <p>When using low-capacity trailing cables, the bending radii are larger than for the previously used standard cables.</p> <p>SEW-EURODRIVE recommends the use of low-capacity cables.</p>

The right-angle plug connectors can be rotated to achieve the required position.

	TIP
	<p>The connector should only be rotated to install and connect the motor.</p> <p>Do not turn the plug connector regularly once it has been installed.</p>

Exemplary positions of the adjustable connectors



63406axx

Figure 8: Positions of the adjustable connectors (examples)



5.2 Wiring information

5.2.1 Protecting the brake control system against interference

To protect the brake control system against interference, do not route unshielded brake cables together with switched-mode power cables.

Switched-mode power cables include in particular:

- Output cables from servo inverters, converters, soft start units and brake units
- Supply cables to braking resistors and similar.

5.2.2 Thermal motor protection

	STOP
	<p>Electromagnetic interference of the drives.</p> <p>Install the connecting lead of the KTY separately from other power cables, maintaining a distance of at least 200 mm. The cables can only be routed together if either the KTY cable or the power cable is shielded.</p>

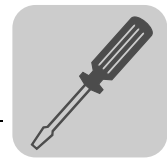

5.3 Connecting motor and encoders system via SM./SB. plug connectors

The CMP synchronous servomotors are supplied with an SM. / SB. plug connector system.

In the basic version, SEW-EURODRIVE delivers CMP synchronous servomotors with a right-angle connector on the motor end and without mating connector. The encoder system is connected using a 12-pin round plug connector.

The mating connectors can be ordered separately or together with the motor.

	STOP
	<p>Adjusting the right-angle connector regularly can cause irreparable damage.</p> <p>Do not align the right-angle connector frequently.</p>

All CMP motors are equipped with quick lock right-angle connectors (SpeedTec). If you use connectors without quick lock, the O-ring serves as vibration protector. The connector can only be screwed on until it reaches the O-ring. The connector is always sealed at the bottom.

If you use self-assembled cables with quick lock, you must remove the O-ring.

5.3.1 Plug connector on the cable end

Unit designation of the plug connectors

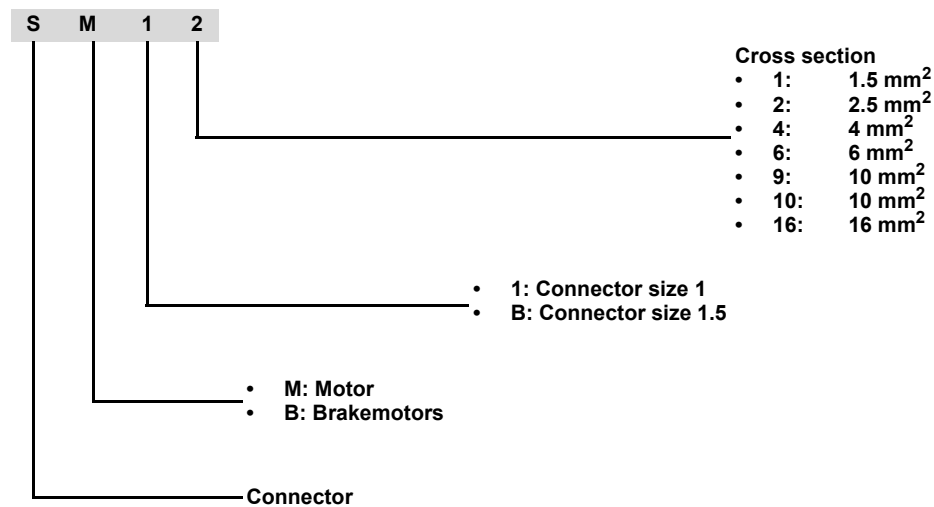



Power cable

Cable type		Plug connector type	Cable cross section [mm ²]	Part number	
				Prefabricated cables	Spare power plug*
Fixed installation	Motor cable	SM11	4 x 1.5 mm ²	0590 4544	0198 6740
		SM12	4 x 2.5 mm ²	0590 4552	0198 6740
		SM14	4 x 4 mm ²	0590 4560	0199 1639
		SMB6	4 x 6 mm ²	1335 0269	1334 9856
		SMB10	4 x 10 mm ²	1335 0277	1334 9864
		SMB16	4 x 16 mm ²	1335 0285	1334 9872
	Brakemotor cable ¹⁾	SB11	4 x 1.5 mm ² + 2 x 1 mm ²	1335 4345	0198 6740
		SB12	4 x 2.5 mm ² + 2 x 1 mm ²	1335 4353	0198 6740
		SB14	4 x 4 mm ² + 2 x 1 mm ²	1335 4361	0199 1639
		SBB6	4 x 6 mm ² + 3 x 1.5 mm ²	1335 0196	1334 9856
		SBB10	4 x 10 mm ² + 3 x 1.5 mm ²	1335 0218	1334 9864
		SBB16	4 x 16 mm ² + 3 x 1.5 mm ²	1335 0226	1334 9872
Cable carrier installation	Motor cable	SM11	4 x 1.5 mm ²	0590 6245	0198 6740
		SM12	4 x 2.5 mm ²	0590 6253	0198 9197
		SM14	4 x 4 mm ²	0590 4803	0199 1639
		SMB6	4 x 6 mm ²	1335 0293	1334 9856
		SMB10	4 x 10 mm ²	1335 0307	1334 9864
		SMB16	4 x 16 mm ²	1335 0315	1334 9872
	Brakemotor cable ¹⁾	SB11	4 x 1.5 mm ² + 2 x 1 mm ²	1335 4388	0198 9197
		SB12	4 x 2.5 mm ² + 2 x 1 mm ²	1335 4396	0198 9197
		SB14	4 x 4 mm ² + 2 x 1 mm ²	1342 1603	0199 1639
		SBB6	4 x 6 mm ² + 3 x 1.5 mm ²	1335 0234	1334 9856
		SBB10	4 x 10 mm ² + 3 x 1.5 mm ²	1335 0242	1334 9864
		SBB16	4 x 16 mm ² + 3 x 1.5 mm ²	1335 0250	1334 9872

1) BP brake: 3-core cable, only 2 cores are used

* The complete connector service pack always includes the following parts:

- Power connector,
- Insulation inserts,
- Socket contacts.



Dependence of mating connector on cable diameter and crimping area

SM1 / SB1 connector type	Crimping area U, V, W, PE [mm ²]	Cable crimping diameter [mm]
01986740	0.35 - 2.5	9 - 14
01989197	0.35 - 2.5	14 - 17
01991639	2.5 - 4	14 - 17

SMB / SBB connector type	Crimping area U, V, W, PE [mm ²]	Cable crimping diameter [mm]
13349856	1.5 - 10	9 - 16
13349864	1.5 - 10	16.5 - 25
13349872	6 - 16	16.5 - 25

The connector service packs also contain the brake pins, so that no difference needs to be made between motor and brakemotor.

Replaced brakemotor cables

The brake cores of the replaced brakemotor cables are labeled differently from today's standard. This applies to the following cables:

Cable type		Plug connector type	Cable cross section [mm ²]	Part number	
				Prefabricated cables	Spare power connector*
Fixed installation	Brakemotor cable ¹⁾	SB11	4 x 1.5 mm ² + 2 x 1 mm ²	1332 4853	0198 6740
		SB12	4 x 2.5 mm ² + 2 x 1 mm ²	1332 2139	0198 6740
		SB14	4 x 4 mm ² + 2 x 1 mm ²	1332 2147	0199 1639
Cable carrier installation	Brakemotor cable ¹⁾	SB11	4 x 1.5 mm ² + 2 x 1 mm ²	1333 1221	0198 9197
		SB12	4 x 2.5 mm ² + 2 x 1 mm ²	1333 2155	0198 9197
		SB14	4 x 4 mm ² + 2 x 1 mm ²	1333 2163	0199 1639

1) BP brake: 3-core cable, only 2 cores are used

The polarity is not relevant when connecting the BP brake, i.e. the replaced cables can still be used.



5.3.2 Feedback and forced cooling fan cable

Feedback cable

Cable type		Cable cross section [mm ²]	FI type	Part number	
				Prefabricated cables	Signal connector*
Fixed installation	Resolver cable	5 x 2 x 0.25 mm ²	MOVIDRIVE®	0199 4875	0198 6732
			MOVIAXIS®	1332 7429	
Cable carrier installation			MOVIDRIVE®	0199 3194	
			MOVIAXIS®	1332 7437	
Fixed installation	Hiperface cable	6 x 2 x 0.25 mm ²	MOVIDRIVE® / MOVIAXIS®	1332 4535	0198 6732
Cable carrier installation			MOVIDRIVE® / MOVIAXIS®	1332 4551	

* The complete connector service pack always includes the following parts:

- Feedback connector,
- Insulation inserts,
- Socket contacts.

Forced cooling fan cable

Cable type		Cable cross section [mm ²]	Part number
Fixed installation	Forced cooling fan cable	3 x 1 mm ²	0198 6341
Cable carrier installation		3 x 1 mm ²	0199 560X

For information on the extension cables for power, feedback and forced cooling fan cables, refer to the "DR, CMP Motors" catalog.

5.3.3 Prefabricated cables

Prefabricated cables are available from SEW-EURODRIVE to connect the SM./SB. plug connector system. For information on the prefabricated cables, refer to the "DR, CMP Motors" catalog.

The plug connectors are depicted with the connector assignment on the cable at the connection side (back).

Note the following points if you want to assemble the cables yourself:

- Chapter 5.4 describes the assembly of the signal plug connectors, and chapter 5.5 the assembly of SM. / SB. power plug connectors.
- The socket contacts for the motor connection are implemented as crimping contacts. Only use suitable tools for crimping.
- Strip the insulation off the leads as described in chapters 5.4 and 5.5. Apply shrink tubing to the connectors.
- Incorrectly installed socket contacts can be removed without removal tools.

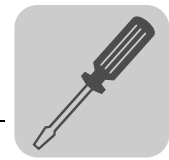

5.3.4 Wiring diagrams for synchronous CMP servomotors

Symbols used

	Plug connector upper part (to be connected by the customer)
	Plug connector lower part (connected at the factory)

Connecting SM1 / SB1 power plug connectors

Wiring diagram
with/without BP
brake

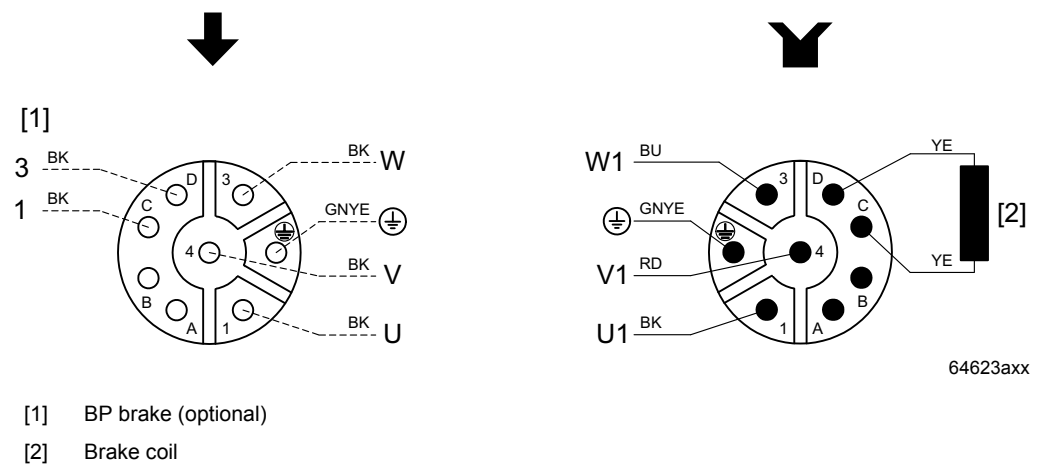

Connecting SM1 / SB1 power plug connectors

Wiring diagram
with/without BY
brake

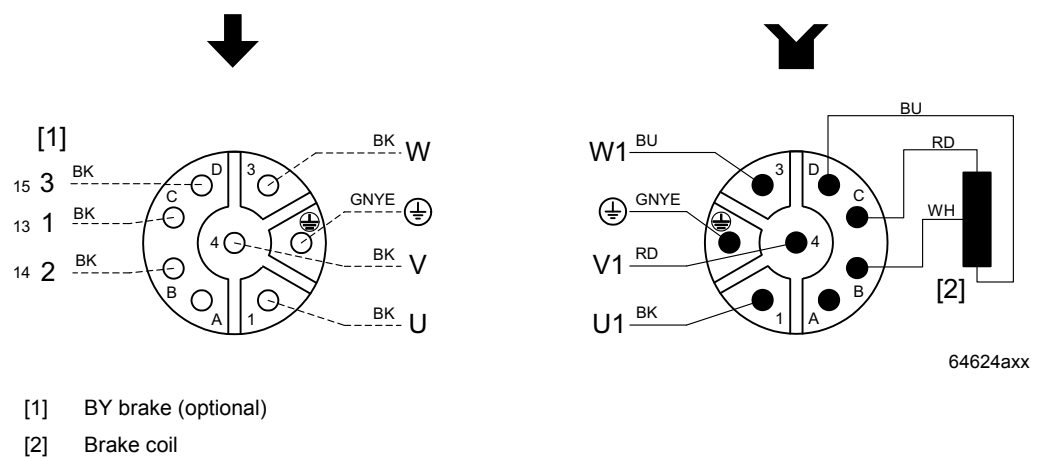



Electrical Installation

Connecting motor and encoders system via SM./SB. plug connectors

Connecting SMB / SBB power plug connectors

Wiring diagram
with/without BP
brake

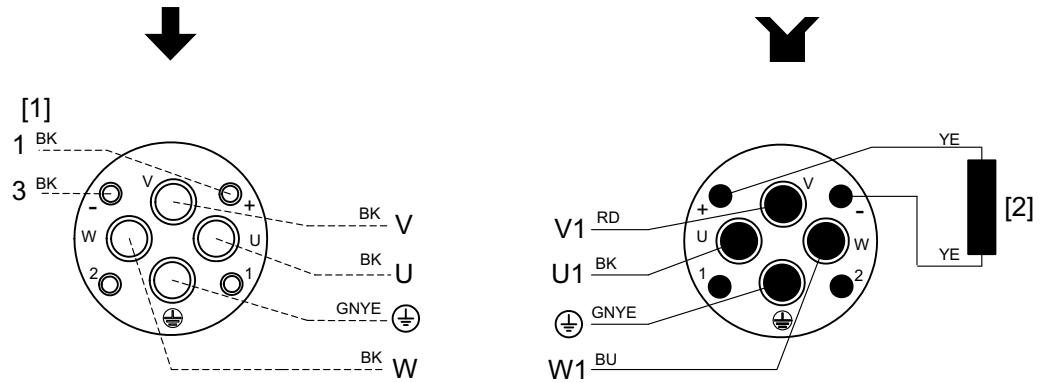

64625axx

- [1] BP brake (optional)
- [2] Brake coil

Connecting SMB / SBB power plug connectors

Wiring diagram
with/without BY
brake

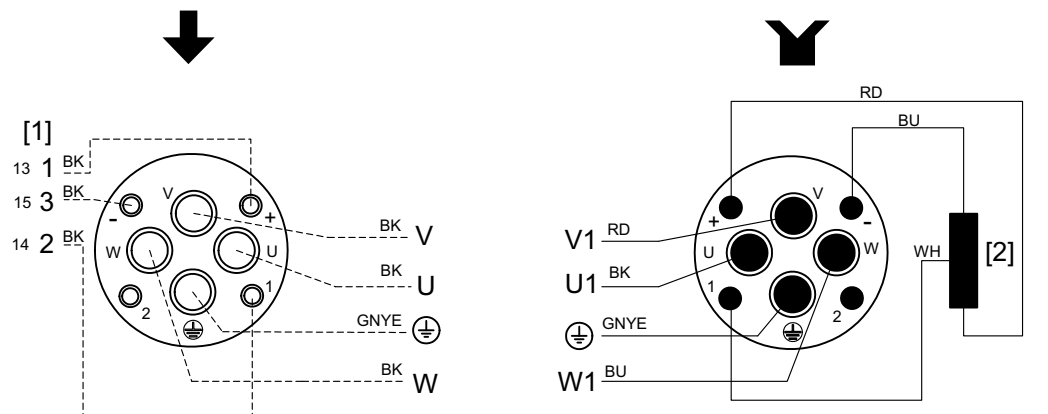

64626axx

- [1] BY brake (optional)
- [2] Brake coil

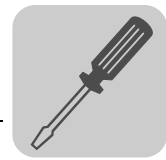

RH1M resolver signal plug connector

Wiring diagram

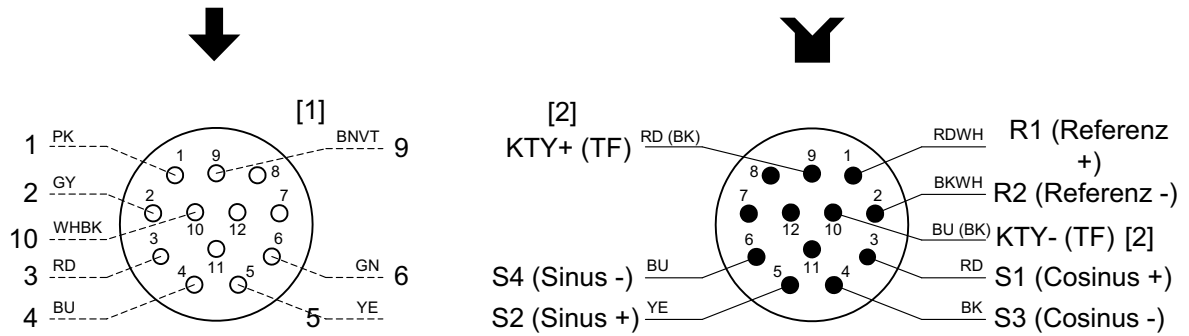

64627axx

ES1H, AS1H, AK0H, EK0H encoder signal plug connector

Wiring diagram

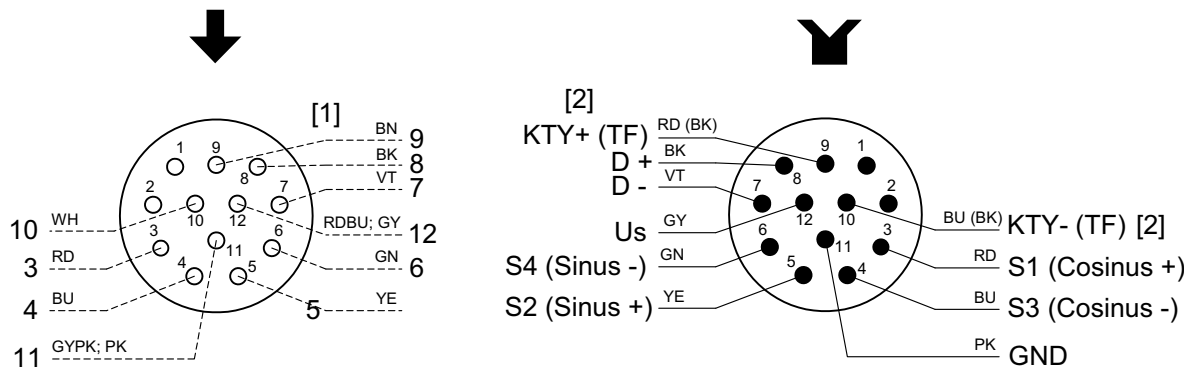

64628axx



Electrical Installation

Assembly of plug connectors for resolver/HIPERFACE®

5.4 Assembly of plug connectors for resolver/HIPERFACE®

5.4.1 Scope of delivery signal plug connectors

The following parts are supplied for assembling resolver/HIPERFACE® plug connectors. The SEW part number is 198 673 2.

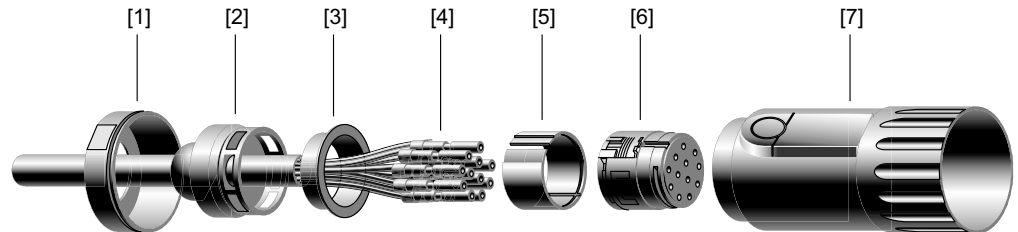

54715AXX

- [1] Screw fitting
- [2] Seal with strain relief
- [3] Shield ring
- [4] Socket contacts
- [5] Insulating sleeve
- [6] Insulator
- [7] Connector housing



TIP

Hold the cable firmly in place when tightening the cable and the connector.



5.4.2 Assembly notes for signal plug connectors

1		<ul style="list-style-type: none"> • Pull the screw fitting and seal with strain relief 31 mm over the cable.
2		<ul style="list-style-type: none"> • Strip 28 mm of cable insulation off the end of the cable
3		<ul style="list-style-type: none"> • Fold back the braid shield and fan it out
4		<ul style="list-style-type: none"> • Strip 6 mm insulation off the leads • Push the socket contacts onto the ends of the leads
5		<ul style="list-style-type: none"> • Insert the small-diameter positioning tool (SEW part number 019 244 9) into the crimping tool until the green mark appears in the view window [A]. • Set the press thickness [B] to 24 on the crimping tool.
6		<ul style="list-style-type: none"> • Insert a lead with socket contact in the crimping tool and press the tool fully together. The tool then opens automatically. • Repeat this procedure for each lead.
7		<ul style="list-style-type: none"> • Pull the shield over the leads and press it against the seal.



Electrical Installation

Assembly of plug connectors for resolver/HIPERFACE®

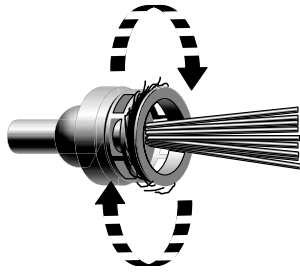
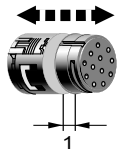
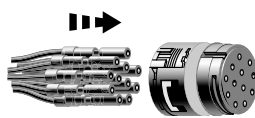
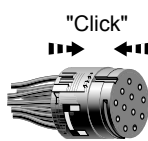
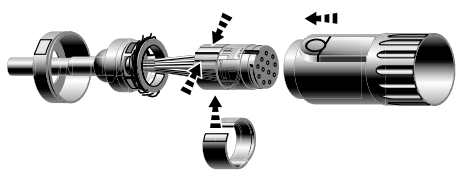
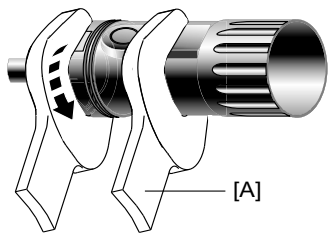
8		<ul style="list-style-type: none"> • Turn the shield ring until the braid shield is flush with the shield ring.
9		<ul style="list-style-type: none"> • Pull the insulator apart evenly by about 1 mm.
10		<ul style="list-style-type: none"> • Insert the socket contacts into the insulator.
11		<ul style="list-style-type: none"> • Press the insulator together until you hear a "click."
12		<ul style="list-style-type: none"> • Fold open the insulating sleeve. • Position the side of the insulating sleeve with the recess against the groove in the insulator so that the opening of the insulating sleeve is pointing in the same direction as the double-headed arrow on the insulator • Press the insulating sleeve together until it engages. • Insert the insulator into the connector housing in the middle position
13		<ul style="list-style-type: none"> • Fix the connector housing with a wrench and use a second wrench to tighten the screw fitting • [A] = Fix in place



5.5 Power connector assembly

The following assembly figure and description are exemplary for the SM / SB power plug connectors. This description can be used analogously for assembling the SMB and SMC power plug connectors.

5.5.1 Scope of delivery of SM. / SB. power plug connectors

The following parts are supplied for assembling the power plug connectors. The SEW part number is 198,674 0.

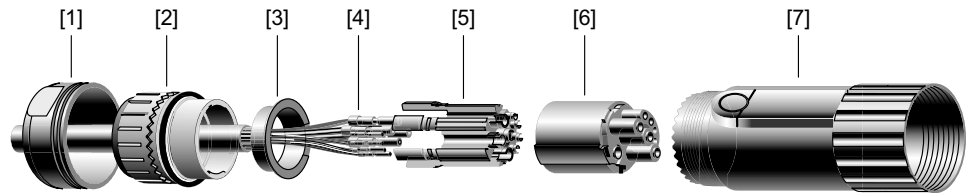

56252AXX

- [1] Screw fitting
- [2] Seal with strain relief
- [3] Shield ring
- [4] Socket contacts
- [5] Insulating sleeve
- [6] Insulator
- [7] Connector housing



TIP

Hold the cable firmly in place when tightening the cable and the connector.



5.5.2 Assembly notes for SM1 / SB1 power connectors

1		<ul style="list-style-type: none"> • Pull the screw fitting and the seal with strain relief over the cable. 															
2		<ul style="list-style-type: none"> • Strip 59 mm of cable insulation off the end of the cable. 															
3		<ul style="list-style-type: none"> • Fold back the braided shield and fan it out. 															
4		<ul style="list-style-type: none"> • Shorten the power leads (1, 2 and 3) to 44 mm. • Shorten the PE lead (GN/YE) to 45 mm. • Do not shorten lead pair 5 and 6. • Cut off lead pair 7 and 8 flush with the end of the cable. 															
5		<ul style="list-style-type: none"> • Pull the shield over the leads. • Strip 7 mm of insulation off leads 1, 2, 3 and PE. • Strip 5 mm of insulation of leads 5 and 6. 															
6		<ul style="list-style-type: none"> • Insert the positioning tool in the crimping tool until the marking (color) appears in the view window [A] appears (see table below). • Set the press thickness [B] on the crimping tool according to the table. <table border="1" data-bbox="710 1624 1434 1783"> <thead> <tr> <th>Lead</th> <th>a [mm²]</th> <th>Positioning tool Part number</th> <th>Marking (color)</th> <th>Press force</th> </tr> </thead> <tbody> <tr> <td>5 and 6</td> <td>0.14 - 1.0</td> <td>019 244 9</td> <td>Green (GN)</td> <td>24</td> </tr> <tr> <td>1, 2, 3 and PE</td> <td>0.35 - 4.0</td> <td>019 245 7</td> <td>Blue (BU)</td> <td>6</td> </tr> </tbody> </table>	Lead	a [mm ²]	Positioning tool Part number	Marking (color)	Press force	5 and 6	0.14 - 1.0	019 244 9	Green (GN)	24	1, 2, 3 and PE	0.35 - 4.0	019 245 7	Blue (BU)	6
Lead	a [mm ²]	Positioning tool Part number	Marking (color)	Press force													
5 and 6	0.14 - 1.0	019 244 9	Green (GN)	24													
1, 2, 3 and PE	0.35 - 4.0	019 245 7	Blue (BU)	6													
7		<ul style="list-style-type: none"> • Insert a lead with socket contact in the crimping tool and press the tool fully together. The tool then opens automatically. • Repeat this procedure for each lead in accordance with the table in step 6. 															



8		<ul style="list-style-type: none"> • Open the insulating sleeve.
9		<ul style="list-style-type: none"> • Insert the middle socket contact into the insulator as shown in the wiring diagram in section 5.3.4. • Close the insulating sleeve until it clicks shut. • Insert the remaining socket contacts into the insulator as shown in the wiring diagram in section 5.3.4.
10		<ul style="list-style-type: none"> • Shorten the braided shield as shown. • Insert the shield ring into the seal so that the shield and end of the cable are flush. Make sure that the braid shield is routed cleanly between the shield ring and the seal.
11		<ul style="list-style-type: none"> • Insert the insulator into the connector housing until the seal rests against its stop in the connector housing.
12		<ul style="list-style-type: none"> • Use a wrench to hold the connector housing in place and use a second wrench to tighten the screw fitting. • [A] = Fix in place



5.5.3 Assembly notes for SMB. / SBB. power connectors

1		<ul style="list-style-type: none"> • Pull the screw fitting and the seal with strain relief over the cable. 												
2		<ul style="list-style-type: none"> • Strip the insulation off the cable end. 												
3		<ul style="list-style-type: none"> • Fold back the braided shield and fan it out. 												
4		<ul style="list-style-type: none"> • Shorten the power leads (U, V, P). • Shorten the PE lead (GN/YE). • Do not shorten leads +, -, 1. • Cut off lead pair 7 and 8 flush with the end of the cable. 												
5		<ul style="list-style-type: none"> • Pull the shield over the leads. • Strip insulation of leads U, V, P and PE. • Strip 5 mm insulation off the leads +, -, 1. 												
6		<ul style="list-style-type: none"> • Insert the positioning tool in the crimping tool until the marking (color) appears in the view window [A] appears (see table below). • Set the press thickness [B] on the crimping tool. <table border="1" data-bbox="710 1592 1436 1749"> <thead> <tr> <th>Lead</th> <th>a [mm²]</th> <th>Positioning tool Part number</th> <th>Marking (color)</th> </tr> </thead> <tbody> <tr> <td>+, -, 1</td> <td>0.35 - 4.0</td> <td>029 461 65</td> <td>Green (GN)</td> </tr> <tr> <td>U, V, W and PE</td> <td>6 - 16.0</td> <td>029 461 65</td> <td>Blue (BU)</td> </tr> </tbody> </table>	Lead	a [mm ²]	Positioning tool Part number	Marking (color)	+, -, 1	0.35 - 4.0	029 461 65	Green (GN)	U, V, W and PE	6 - 16.0	029 461 65	Blue (BU)
Lead	a [mm ²]	Positioning tool Part number	Marking (color)											
+, -, 1	0.35 - 4.0	029 461 65	Green (GN)											
U, V, W and PE	6 - 16.0	029 461 65	Blue (BU)											
7		<ul style="list-style-type: none"> • Insert a lead with socket contact in the crimping tool and press the tool fully together. The tool then opens automatically. • Repeat this procedure for each lead in accordance with the table in step 6. 												



8		<ul style="list-style-type: none"> • Open the insulating sleeve.
9		<ul style="list-style-type: none"> • Insert the middle socket contact into the insulator as shown in the wiring diagram in section 5.3.4. • Close the insulating sleeve until it clicks shut. • Insert the remaining socket contacts into the insulator as shown in the wiring diagram in section 5.3.4.
10		<ul style="list-style-type: none"> • Shorten the braided shield as shown. • Insert the shield ring into the seal so that the shield and end of the cable are flush. Make sure that the braid shield is routed cleanly between the shield ring and the seal.
11		<ul style="list-style-type: none"> • Insert the insulator into the connector housing until the seal rests against its stop in the connector housing.
12		<ul style="list-style-type: none"> • Use a wrench to hold the connector housing in place and use a second wrench to tighten the screw fitting. • [A] = Fix in place



5.6 Thermal motor protection

	STOP
	<p>Due to the low thermal time constants of the winding, thermal motor protection for CMP40 - CMP71S motors is only possible when, in addition to a temperature sensor, a current monitoring device (I^2t, effective current monitoring) or a motor model for thermal protection, as installed in SEW servo systems, is activated.</p> <p>Complete motor protection at full motor utilization is only ensured if the signals are evaluated by SEW-EURODRIVE inverters.</p>

KTY84 - 130 temperature sensor

	STOP
	<p>Possible damage to the temperature sensor and the motor winding.</p> <p>Use test currents < 3 mA in the circuit of the KTY since high self-heating of the temperature sensor can damage its insulation and the motor winding.</p> <p>It is essential to observe the correct connection of the KTY to ensure correct evaluation of the temperature sensor.</p>

Typical characteristic curve of KTY:

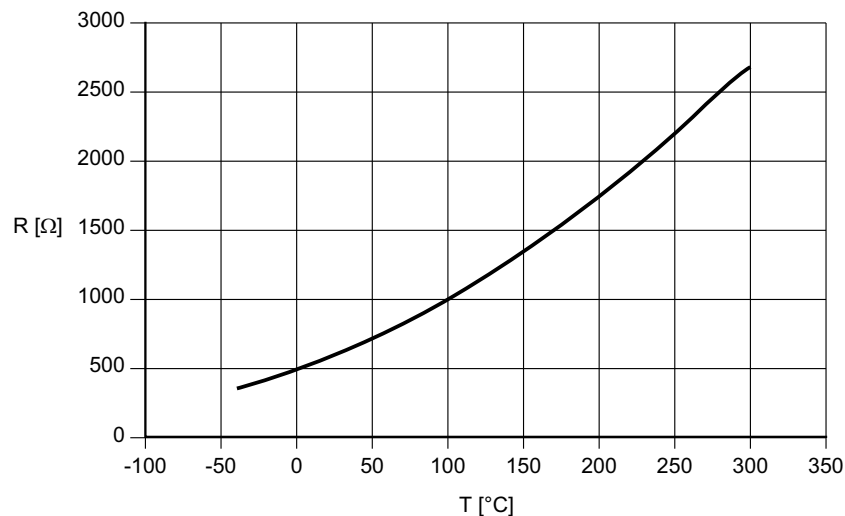
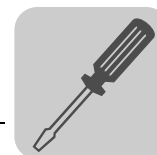

Figure 9: Resistance of the KTY sensor depending on the motor temperature

63578axx

For detailed information on connecting the KTY sensor, refer to the contact assignments of resolver/encoder cables. Observe the correct polarity.



5.7 VR forced cooling fan

The synchronous servomotors size CMP50 - CMP100 can be equipped with a VR forced cooling fan as an option.

Mechanical installation

Mounting the fan guard for the VR forced cooling fan:

Motor	Screws	Tightening torque
CMP50, CMP63	M4 × 8, self-tapping	4 Nm
CMP71 ¹⁾	M6 × 20	10.3 Nm
CMP80, CMP100 ¹⁾	M8 × 20	25.5 Nm

1) In preparation

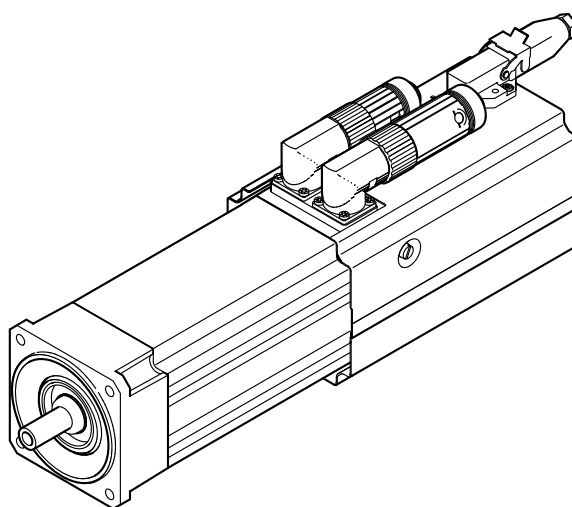

Figure 10: CMP63 synchronous servomotor with forced cooling fan

53865AXX



Electrical Installation

VR forced cooling fan

Electrical connection

The VR forced cooling fan is only available for 24 V DC voltage.

- DC 24 V \pm 20 %
- Plug connector connection
- Maximum connection cross section 2 x 1 mm²
- Cable gland Pg7 with inside diameter 7 mm

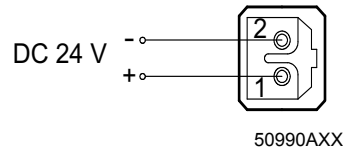

Connector contact	Connection
1	24 V +
2	0 V

Retrofit set for CMP50 - CMP100



TIP

The forced cooling fan retrofit set for the motors CMP50 and CMP100 may only be mounted by staff authorized by SEW-EURODRIVE.

For information on the retrofit set, refer to the "DR, CMP Motors" catalog.



5.8 Connecting the brake

- BP holding brake** The mechanical brake is a holding brake implemented as a spring-loaded brake. The brake has a standard supply voltage of DC 24 V and operates with one or two braking torque ratings for each motor size. For assignment, see page 50.
- The brake cannot be retrofitted and usually operates without brake rectifier or brake control unit.
- If the servomotors are operated on the MOVIAXIS[®] servo inverter, overvoltage protection is provided.
- If the servomotors are operated on MOVIDRIVE[®] or inverters from other manufacturers, overvoltage protection must be implemented by the customers themselves using, for example, varistors.
- Observe the notes in the relevant operating instructions for the inverters concerning the switching sequence of motor enable and brake control during standard operation.
- The BP brake can be used for the following rated speeds depending on the motor size. For motor/brake assignment, see page 50.

Brake size	Rated speed [rpm]
BP01 - BP1	3000, 4500, 6000
BP3 - BP5	3000, 4500



6 Startup

6.1 Prerequisites for startup

	<p>⚠ DANGER</p>
	<p>Danger of electric shock.</p> <p>Severe or fatal injuries!</p> <ul style="list-style-type: none"> • Observe the safety notes in chapter 2 during installation. • Switch contacts in utilization category AC-3 to EN 60947-4-1 must be used for switching the motor and the brake. • When motors are powered by inverters, you must adhere to the wiring instructions issued by the inverter manufacturer. • It is essential to observe the operating instructions supplied with the servo inverter.

	<p>TIP</p>
	<p>The rated speed of the motor in a gearmotor can be higher than the permitted, input speed of the gear unit.</p> <p>Limit the maximum speed at the servo inverter. For information on the procedure, refer to the documentation of the servo inverter.</p>

Before startup

- The drive must be undamaged and not blocked.
- After a longer storage period, you must perform the measures described in chapter 4.3 "Preliminary work".
- All connections must be established correctly.
- All protective covers have to be fitted correctly.
- All motor protection devices must be active.
- There must be no other sources of danger present.
- No heat-sensitive or insulating materials are allowed to cover the motor surface.

During startup

- The servomotor must run correctly (e.g. no overload, no unwanted speed fluctuations, no loud noises, correct direction of rotation).
- In case of problems, refer initially to section 7, "Faults."

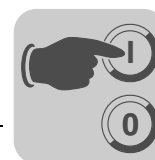

7 Malfunions

7.1 Malfunions of the servomotor

Malfunction	Possible cause	Remedy
Motor does not start up	Supply cable interrupted	Check connections, correct if necessary
	Fuse has blown	Replace fuse
	Motor protection has triggered	Check motor protection for correct setting, correct fault if necessary
	Inverter faulty, overloaded, incorrectly wired or incorrectly set	Check inverter, check wiring
Incorrect direction of rotation	Incorrect setpoint polarity	Check inverter, check setpoints
Motor hums and has high current consumption	Drive is blocked	Check drive
	Brake does not release	See section 7.3, "Brake faults"
	Encoder cable malfunction	Check encoder cable
	Wrong inverter setting	Check the inverter
Motor heats up excessively (measure temperature, significantly higher than 100 °C)	Overload	Measure power, use larger motor or reduce load if necessary, check travel profile
	Ambient temperature is too high	Comply with permitted temperature range
	Insufficient cooling	Correct cooling air supply or clear cooling air passages, retrofit forced cooling fan if necessary
	Forced cooling fan does not run	Check connection, correct if necessary
	Rated operating mode (S1 to S10, EN 60034) exceeded, e.g. caused by excessive torque	Adjust the rated operating mode of the motor to the required operating conditions; consult a professional to determine the correct drive if necessary
Running noise on motor	Inverter not optimized	Check the inverter
	Bearing damage	<ul style="list-style-type: none"> • Contact SEW-EURODRIVE customer service • Replace the motor
	Vibration of rotating parts	Rectify cause, possible imbalance
	Forced cooling fan: Foreign bodies in cooling air passages	Clean the cooling air passages

7.2 Malfunions of the servo inverter

	TIP
	The symptoms described in chapter 7.1 may also occur when the servomotor is operated with a servo inverter. Refer to the servo inverter operating instructions for the meaning of the problems that occur and to find information about rectifying the problems.

Please have the following information to hand if you require the assistance of our customer service:

- Complete nameplate data.
- Type and extent of the problem.
- Time the problem occurred and any accompanying circumstances.
- Assumed cause



7.3 Malfunctions of the brake

BP brake





Malfunction	Possible cause	Remedy
Brake does not release	Brake connected incorrectly	Check brake connection
	Max. permitted working air gap exceeded because brake lining worn down	<ul style="list-style-type: none"> Consult SEW-EURODRIVE Replace the motor
	Incorrect voltage at brake control unit, e.g. voltage drop in the supply cable > 10 %	Check voltage at motor connection: Ensure correct connection voltage; check cable cross section
	Brake coil has interturn short circuit or a short circuit to frame	Consult SEW-EURODRIVE
Motor does not brake	Brake lining worn down	<ul style="list-style-type: none"> Consult SEW-EURODRIVE Replace the motor
	Incorrect braking torque.	<ul style="list-style-type: none"> Consult SEW-EURODRIVE Replace the motor
Noises/squeaking in vicinity of brake	Brake parameters set incorrectly in the inverter	Check brake release and application times

BY brake

Malfunction	Possible cause	Remedy
Brake does not release	Brake control unit failed	Install a new brake control system, check internal resistance and insulation of brake coil, check switch-gear
	Brake connected incorrectly	Check brake connection
	Max. permitted working air gap exceeded because brake lining worn down	<ul style="list-style-type: none"> Consult SEW-EURODRIVE Brake disk replacement by SEW-trained staff
	Brake coil has interturn short circuit or a short circuit to frame	<ul style="list-style-type: none"> Check switchgear Replace the entire brake and brake control system (consult SEW-EURODRIVE)
Motor does not brake	Brake lining worn down	<ul style="list-style-type: none"> Consult SEW-EURODRIVE Brake disk replacement by SEW-trained staff
	Incorrect braking torque.	<ul style="list-style-type: none"> Consult SEW-EURODRIVE Brake disk replacement by SEW-trained staff
	Manual brake release device not set correctly	Set the setting nuts correctly
Brake is applied with time lag	Brake is switched on AC voltage side	Switch both, the DC and AC voltage sides; observe wiring diagram
Noises/squeaking in vicinity of brake	Brake parameters set incorrectly in the inverter	Check brake release and application times



8 Inspection/Maintenance

	<p>⚠ CAUTION</p> <p>Only use original spare parts, otherwise the motor can be damaged. Possible damage to property!</p> <ul style="list-style-type: none"> • Only use genuine spare parts in accordance with the valid parts list.
	<p>⚠ CAUTION</p> <p>The motor must be disassembled when replacing the brake which cannot be adjusted. Possible damage to the BY brake</p> <ul style="list-style-type: none"> • Only SEW-EURODRIVE may perform maintenance on the BY brake because the encoder or resolver has to be reset each time the system is disassembled.
	<p>⚠ DANGER</p> <p>The servomotor has live parts during and after operation. Severe or fatal injuries from electric shock.</p> <ul style="list-style-type: none"> • De-energize all power, brake and signal cables before unplugging the power or signal plug connector. • Secure the motors against unintended power-up. • The motor can generate power when the shaft is rotated. Do not touch the connector pins.
	<p>⚠ WARNING</p> <p>The servomotor can have a surface temperature of more than 100 °C during operation. Risk of burns and fire.</p> <ul style="list-style-type: none"> • Never touch the CMP synchronous servomotor during operation or in the cool down phase once it has been switched off.



8.1 Inspection intervals

The amount of wear depends on many factors and may be high. The required inspection intervals must be calculated individually in line with project planning documents from the system manufacturer.

	TIP
	Observe the data of the machine and system manufacturer in the machine maintenance schedule.

Cleaning

Excessive dirt, dust or shavings can have a negative impact on the function of servomotors; in extreme cases these factors can cause the servomotor to break down.

Therefore, you must clean the servomotors at regular intervals (after one year at the latest) to ensure a sufficiently large area for heat emission.

Insufficient heat emission can have unwanted consequences. The bearing service life is reduced through operation at impermissibly high temperatures (bearing grease degrades).

Connection cables

Check connection cables for damage at regular intervals and replace if necessary.

	! DANGER
	<p>The servomotor has live parts during and after operation. Severe or fatal injuries from electric shock.</p> <ul style="list-style-type: none"> • De-energize all power, brake and signal cables before unplugging the power or signal plug connector. • Secure the motors against unintended power-up. • The motor can generate power when the shaft is rotated. Do not touch the connector pins. • Do not perform temporary repairs on the connection cables. When the cable jacket is defective, no matter how small the fault, shut down the system immediately and replace the cables.

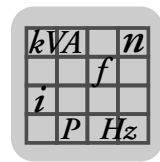

9 Technical Data

9.1 Key to the data tables

The following table lists the short symbols used in the "Technical Data" tables.

n_N	Rated speed
M_0	Standstill torque (thermal continuous torque at low speeds)
I_0	Standstill current
M_{pk}	Maximum limit torque of the servomotors
I_{max}	Maximum permitted motor current
M_{0VR}	Standstill torque with forced cooling fan
I_{0VR}	Standstill current with forced cooling fan
J_{mot}	Mass moment of inertia of the motor
J_{bmot}	Mass moment of inertia of the brakemotor
M_{B1}	Standard braking torque
M_{B2}	Optional braking torque
L_1	Inductivity between connection phase and star point
R_1	Resistance between connection phase and star point
U_{p0} cold	Internal voltage at 1000 rpm

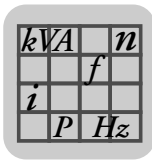

9.2 Technical data – Synchronous CMP servomotors

System voltage: 400 V

n_N [min ⁻¹]	Motor	M_0 [Nm]	I_0 [A]	M_{pk} [Nm]	I_{max} [A]	M_{0VR} [Nm]	I_{0VR} [A]	m [kg]	J_{mot} [10 ⁻⁴ kgm ²]	L_1 [mH]	R_1 Ω	U_{p0} cold [V]
3000	CMP40S	0.5	1.2	1.9	6.1	-	-	1.3	0.1	23	11.94	27.5
	CMP40M	0.8	0.95	3.8	6.0	-	-	1.6	0.15	46	19.93	56
	CMP50S	1.3	0.96	5.2	5.1	1.7	1.25	2.3	0.42	71	22.49	86
	CMP50M	2.4	1.68	10.3	9.6	3.5	2.45	3.3	0.67	38.5	9.96	90
	CMP50L	3.3	2.2	15.4	13.6	4.8	3.2	4.1	0.92	30.5	7.42	98
	CMP63S	2.9	2.15	11.1	12.9	4	3	4.0	1.15	36.5	6.79	90
	CMP63M	5.3	3.6	21.4	21.6	7.5	5.1	5.7	1.92	22	3.56	100
	CMP63L	7.1	4.95	30.4	29.7	10.3	7.2	7.5	2.69	14.2	2.07	100
	CMP71S	6.4	4.9	19.2	25	8.7	6.7	7	3.01	15.7	1.48	87.5
	CMP71M	9.4	7.5	30.8	39	13.7	10.9	8.4	4.06	9.7	0.81	85
	CMP71L	13.1	9.4	46.9	58	21	15.1	11.4	6.16	7.3	0.56	96
	CMP80S	13.4	10	42.1	47	18.5	13.8	12.8	8.39	7.2	0.54	91
	CMP80M	18.7	13.4	62.6	69	27	19.3	16.5	11.51	5	0.345	94
	CMP80L	27.5	18.7	107	107	44	30	21.4	17.72	3.35	0.21	99
	CMP100S	25.5	19.6	68.3	73	36	27.5	19.8	19.34	3.9	0.215	88
CMP100M	31	21.8	108	102	47	33	24.8	26.25	3.05	0.142	95.5	
CMP100L	47	32.3	178.8	167	70	48	34.6	40	1.9	0.081	98	
4500	CMP40S	0.5	1.2	1.9	6.1	-	-	1.3	0.1	23	11.94	27.5
	CMP40M	0.8	0.95	3.8	6.0	-	-	1.6	0.15	46	19.93	56
	CMP50S	1.3	1.32	5.2	7.0	1.7	1.7	2.3	0.42	37	11.61	62
	CMP50M	2.4	2.3	10.3	13.1	3.5	3.35	3.3	0.67	20.5	5.28	66
	CMP50L	3.3	3.15	15.4	19.5	4.8	4.6	4.1	0.92	14.6	3.57	68
	CMP63S	2.9	3.05	11.1	18.3	4	4.2	4.0	1.15	18.3	3.34	64
	CMP63M	5.3	5.4	21.4	32.4	7.5	7.6	5.7	1.92	9.8	1.48	67
	CMP63L	7.1	6.9	30.4	41.4	10.3	10	7.5	2.69	7.2	1.07	71
	CMP71S	6.4	7.3	19.2	38	8.7	9.9	7	3.01	7.1	0.72	59
	CMP71M	9.4	10.9	30.8	57	13.7	15.9	8.4	4.06	4.55	0.385	58
	CMP71L	13.1	14.1	46.9	87	21	22.5	11.4	6.16	3.25	0.24	64
	CMP80S	13.4	15.3	42.1	73	18.5	21	12.8	8.39	3.05	0.22	59
	CMP80M	18.7	20.1	62.6	103	27	29	16.5	11.51	2.25	0.148	63
	CMP80L	27.5	27.8	107	159	44	44.5	21.4	17.72	1.54	0.085	67
	CMP100S	25.5	30	68.3	111	36	42.5	19.8	19.34	1.68	0.086	58
CMP100M	31	33.1	108	154	-	-	24.8	26.25	1.32	0.058	63	
CMP100L	47	48.4	178.8	251	-	-	34.6	40	0.84	0.038	65	
6000	CMP40S	0.5	1.2	1.9	6.1	-	-	1.3	0.1	23	11.94	27.5
	CMP40M	0.8	1.1	3.8	6.9	-	-	1.6	0.15	34	14.95	48.5
	CMP50S	1.3	1.7	5.2	9.0	1.7	2.2	2.3	0.42	22.5	7.11	48.5
	CMP50M	2.4	3	10.3	17.1	3.5	4.4	3.3	0.67	12	3.21	50.5
	CMP50L	3.3	4.2	15.4	26	4.8	6.1	4.1	0.92	8.2	1.91	51
	CMP63S	2.9	3.9	11.1	23.4	4	5.4	4.0	1.15	11.2	2.1	50
	CMP63M	5.3	6.9	21.4	41.4	7.5	9.8	5.7	1.92	5.9	0.92	52
	CMP63L	7.1	9.3	30.4	55.8	10.3	13.5	7.5	2.69	4	0.62	53
	CMP71S	6.4	9.6	19.2	50	8.7	13.1	7	3.01	4.15	0.395	45
	CMP71M	9.4	14.7	30.8	76	13.7	21.5	8.4	4.06	2.55	0.205	43.5
	CMP71L	13.1	18.8	46.9	115	21	30	11.4	6.16	1.84	0.145	48
	CMP80S	13.4	20	42.1	95	18.5	27.5	12.8	8.39	1.8	0.136	46
CMP80M	18.7	26.4	62.6	135	27	38	16.5	11.51	1.3	0.087	48	
CMP80L	27.5	37.6	107	215	-	-	21.4	17.72	0.84	0.051	50	

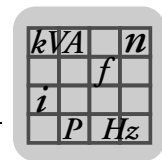

9.3 Technical data – Synchronous CMP../BP servo brakemotors

System voltage: 400 V

n_N [min ⁻¹]	Motor	M_0	I_0	M_{pk}	I_{max}	M_{0VR}	I_{0VR}	m	J_{mot}	L_1	R_1	U_{p0} cold	m_{bmot}	J_{bmot}	M_{B1}	M_{B2}
		[Nm]	[A]	[Nm]	[A]	[Nm]	[A]	[kg]	[kgcm ²]	[mH]	Ω	[V]	[kg]	[kgcm ²]	[Nm]	
3000	CMP40S	0.5	1.2	1.9	6.1	-	-	1.3	0.1	23	11.94	27.5	1.7	0.13	0.95	--
	CMP40M	0.8	0.95	3.8	6.0	-	-	1.6	0.15	46	19.93	56	2.0	0.18	0.95	--
	CMP50S	1.3	0.96	5.2	5.1	1.7	1.25	2.3	0.42	71	22.49	86	2.9	0.48	3.1	4.3
	CMP50M	2.4	1.68	10.3	9.6	3.5	2.45	3.3	0.67	38.5	9.96	90	3.9	0.73	4.3	3.1
	CMP50L	3.3	2.2	15.4	13.6	4.8	3.2	4.1	0.92	30.5	7.42	98	4.7	0.99	4.3	3.1
	CMP63S	2.9	2.15	11.1	12.9	4	3	4.0	1.15	36.5	6.79	90	5.0	1.49	7	9.3
	CMP63M	5.3	3.6	21.4	21.6	7.5	5.1	5.7	1.92	22	3.56	100	6.7	2.26	9.3	7
	CMP63L	7.1	4.95	30.4	29.7	10.3	7.2	7.5	2.69	14.2	2.07	100	8.5	3.03	9.3	7
	CMP71S	6.4	4.9	19.2	25	8.7	6.7	7	3.01	15.7	1.48	87.5	9	3.45	7	14
	CMP71M	9.4	7.5	30.8	39	13.7	10.9	8.4	4.06	9.7	0.81	85	10.4	4.5	14	7
	CMP71L	13.1	9.4	46.9	58	21	15.1	11.4	6.16	7.3	0.56	96	13.4	6.6	14	7
	CMP80S	13.4	10	42.1	47	18.5	13.8	12.8	8.39	7.2	0.54	91		9.79	15	31
	CMP80M	18.7	13.4	62.6	69	27	19.3	16.5	11.51	5	0.345	94		12.91	31	15
	CMP80L	27.5	18.7	107	107	44	30	21.4	17.72	3.35	0.21	99		19.11	31	15
CMP100S	25.5	19.6	68.3	73	36	27.5	19.8	19.34	3.9	0.215	88	22.8	22.16	24	47	
CMP100M	31	21.8	108	102	47	33	24.8	26.25	3.05	0.142	95.5	27.8	29.06	47	24	
CMP100L	47	32.3	178.8	167	70	48	34.6	40	1.9	0.081	98	37.6	42.82	47	24	
4500	CMP40S	0.5	1.2	1.9	6.1	-	-	1.3	0.1	23	11.94	27.5	1.7	0.13	0.85	--
	CMP40M	0.8	0.95	3.8	6.0	-	-	1.6	0.15	46	19.93	56	2.0	0.18	0.95	--
	CMP50S	1.3	1.32	5.2	7.0	1.7	1.7	2.3	0.42	37	11.61	62	2.9	0.48	3.1	4.3
	CMP50M	2.4	2.3	10.3	13.1	3.5	3.35	3.3	0.67	20.5	5.28	66	3.9	0.73	4.3	3.1
	CMP50L	3.3	3.15	15.4	19.5	4.8	4.6	4.1	0.92	14.6	3.57	68	4.7	0.99	4.3	3.1
	CMP63S	2.9	3.05	11.1	18.3	4	4.2	4.0	1.15	18.3	3.34	64	5.0	1.49	7	9.3
	CMP63M	5.3	5.4	21.4	32.4	7.5	7.6	5.7	1.92	9.8	1.48	67	6.7	2.26	9.3	7
	CMP63L	7.1	6.9	30.4	41.4	10.3	10	7.5	2.69	7.2	1.07	71	8.5	3.03	9.3	7
	CMP71S	6.4	7.3	19.2	38	8.7	9.9	7	3.01	7.1	0.72	59	9	3.45	7	14
	CMP71M	9.4	10.9	30.8	57	13.7	15.9	8.4	4.06	4.55	0.385	58	10.4	4.5	14	7
	CMP71L	13.1	14.1	46.9	87	21	22.5	11.4	6.16	3.25	0.24	64	13.4	6.6	14	7
	CMP80S	13.4	15.3	42.1	73	18.5	21	12.8	8.39	3.05	0.22	59		9.79	15	31
	CMP80M	18.7	20.1	62.6	103	27	29	16.5	11.51	2.25	0.148	63		12.91	31	15
	CMP80L	27.5	27.8	107	159	44	44.5	21.4	17.72	1.54	0.085	67		19.11	31	15
CMP100S	25.5	30	68.3	111	36	42.5	19.8	19.34	1.68	0.086	58	22.8	22.16	24	47	
CMP100M	31	33.1	108	154	-	-	24.8	26.25	1.32	0.058	63	27.8	29.06	47	24	
CMP100L	47	48.4	178.8	251	-	-	34.6	40	0.84	0.038	65	37.6	42.82	47	24	
6000	CMP40S	0.5	1.2	1.9	6.1	-	-	1.3	0.1	23	11.94	27.5	1.7	0.13	0.95	--
	CMP40M	0.8	1.1	3.8	6.9	-	-	1.6	0.15	34	14.95	48.5	2.0	0.18	0.95	--
	CMP50S	1.3	1.7	5.2	9.0	1.7	2.2	2.3	0.42	22.5	7.11	48.5	2.9	0.48	3.1	4.3
	CMP50M	2.4	3	10.3	17.1	3.5	4.4	3.3	0.67	12	3.21	50.5	3.9	0.73	4.3	3.1
	CMP50L	3.3	4.2	15.4	26	4.8	6.1	4.1	0.92	8.2	1.91	51	4.7	0.99	4.3	3.1
	CMP63S	2.9	3.9	11.1	23.4	4	5.4	4.0	1.15	11.2	2.1	50	5.0	1.49	7	9.3
	CMP63M	5.3	6.9	21.4	41.4	7.5	9.8	5.7	1.92	5.9	0.92	52	6.7	2.26	9.3	7
	CMP63L	7.1	9.3	30.4	55.8	10.3	13.5	7.5	2.69	4	0.62	53	8.5	3.03	9.3	7
	CMP71S	6.4	9.6	19.2	50	8.7	13.1	7	3.01	4.15	0.395	45	9	3.45	7	14
	CMP71M	9.4	14.7	30.8	76	13.7	21.5	8.4	4.06	2.55	0.205	43.5	10.4	4.5	14	7
CMP71L	13.1	18.8	46.9	115	21	30	11.4	6.16	1.84	0.145	48	13.4	6.6	14	7	

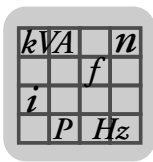

Technical Data

Technical data of the BP brake

9.4 Technical data of the BP brake

The following table lists the technical data of the brakes. The type and number of brake springs determines the level of the braking torque. Maximum braking torque $M_{B \max}$ is installed as standard, unless specified otherwise in the order. Other brake spring combinations can result in reduced braking torque values $M_{B \text{red}}$.

Brake type	$M_{B \max}$ [Nm]	$M_{B \text{red}}$ [Nm]	W_1 [kJ]	W_2 [kJ]	W_3 [10 ³ kJ]	P [W]	t_1 [ms]	t_2 [ms]
BP01	0.95	-	0.4	4.8	1	7	25	15
BP04	4.3	3.1	0.6	7.2	1.5	10.2	60	15
BP09	9.3	7	1	10	2.5	16	60	15
BP1	14	7	1.4	16.8	3.5	19.5	50	15
BP3	31	15	2.2	26.4	5.5	28	70	15
BP5	47	24	3.6	43.2	9	33	110	15

$M_{B \max}$ = Maximum braking torque

$M_{B \text{red}}$ = Optional braking torque

W_1 = Permitted braking work per cycle

W_2 = Permitted braking work per hour

W_3 = Overall permitted braking work

P = Power consumption of the coil

t_1 = Response time

t_2 = Application time



TIP

The response and application times are recommended values in relation to the maximum braking torque.

Motor assignment

The following table shows the standard assignments of motors and brakes:

Motor type	Brake type	M_{B1} [Nm]	M_{B2} [Nm]	Speed class
CMP40	BP01	0.95	-	3000 / 4500 / 6000
CMP50S	BP04	3.1	4.3	
CMP50M/L		4.3	3.1	
CMP63S	BP09	7	9.3	
CMP63M/L		9.3	7	
CMP71S	BP1	7	14	
CMP71M/L		14	7	
CMP80S	BP3	15	31	3000 / 4500
CMP80M/L		31	15	
CMP100S	BP5	24	47	
CMP100M/L		47	24	

M_{B1} Preferred braking torque

M_{B2} Optional braking torque

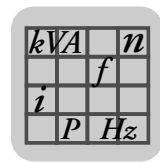

Operating currents for BP brake

	BP01	BP04	BP09	BP1	BP3	BP5
Max. braking torque [Nm]	0.95	4.3	9.3	14	31	47
Braking power [W]	7	10.2	16	19.5	28	33

Rated voltage V_R							
	V_{DC}	I [A _{DC}]	I [A _{DC}]	I [A _{DC}]	I [A _{DC}]	I [A _{DC}]	I [A _{DC}]
	24 (24-25)	0.29	0.42	0.67	0.81	1.17	1.38

I Operating current
 V_N Rated voltage (rated voltage range)

Resistance of BP brake coils

	BP01	BP04	BP09	BP1	BP3	BP5
Max. braking torque [Nm]	0.95	4.3	9.3	14	31	47
Braking power [W]	7	10.2	16	19.5	28	33

Rated voltage V_R							
	V_{DC}	R [Ω]	R [Ω]	R [Ω]	R [Ω]	R [Ω]	R [Ω]
	24 (24-25)	84	56.5	35	29.4	20.5	17.3

R Coil resistance at 20 °C
 V_N Rated voltage (rated voltage range)

kVA	n
	f
i	
P	Hz

Technical Data

Technical data of the BP brake

Block diagram for BMV brake control

In every application, the BP holding brake can be controlled via the BMV brake relay or a customer relay with varistor overvoltage protection.

If the system complies with the specifications for direct brake control, a BP brake can also be controlled directly via the brake output of a MOVIAXIS® servo inverter.

However, the brakes of motors CMP80 and CMP100 can never be directly connected to MOVIAXIS®. For detailed information, refer to the "MOVIAXIS® Multi-Axis Servo Inverter" project planning manual.

Brake control system BMV

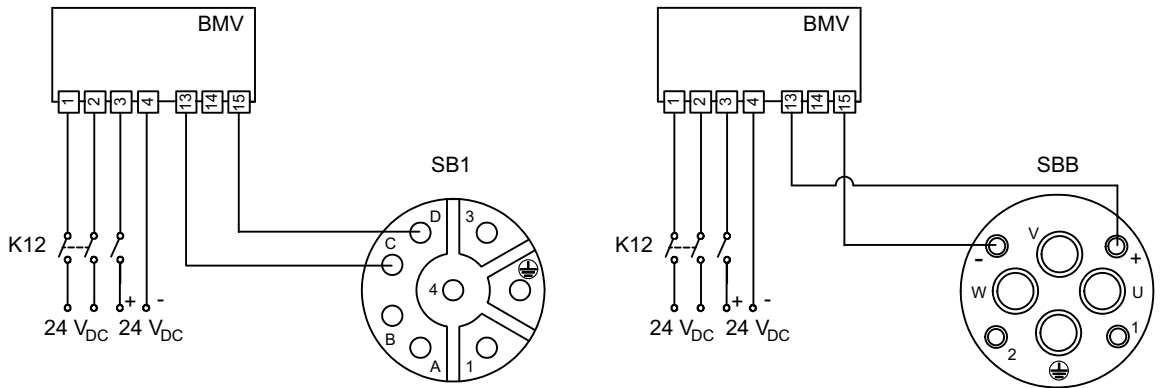

64842axx

BS brake control

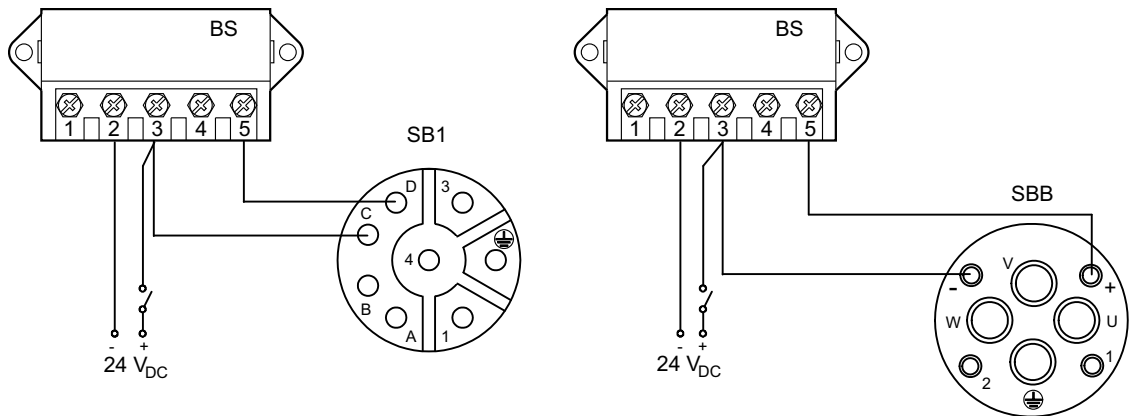

64858axx

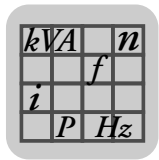

Direct 24 V brake supply

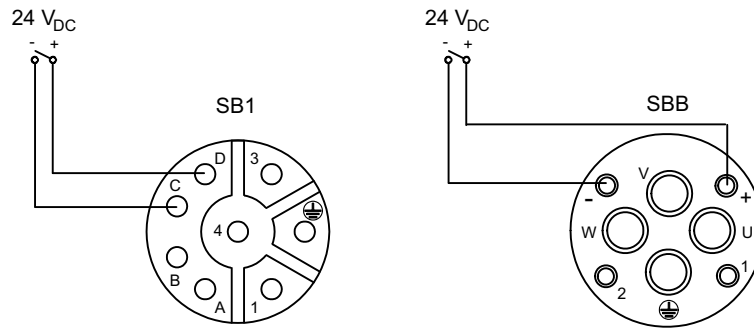

64859axx

Wiring diagram for brake control

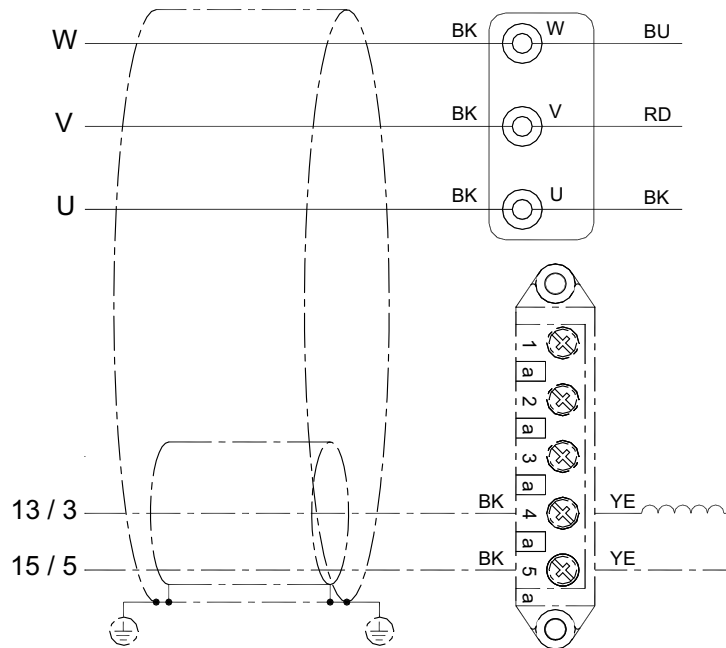

64860axx

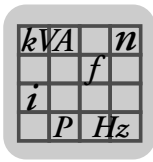

Dimension sheets for BMV brake control

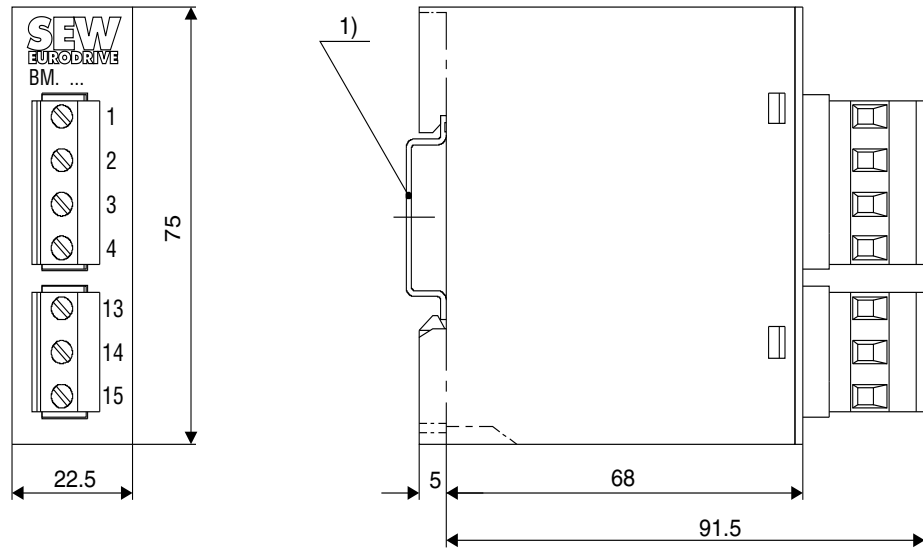

01645BXX

[1] Support rail mounting EN 50022-35-7.5

Dimension sheets for BS brake control

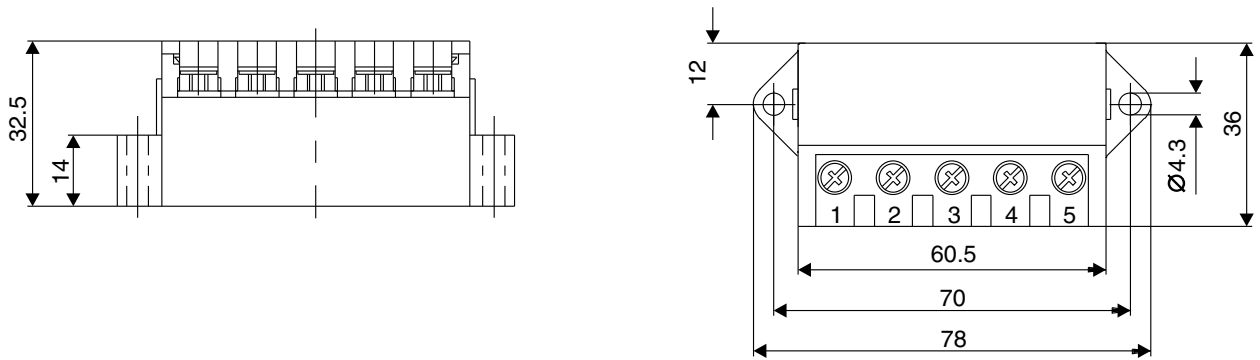

01621BXX



10 Index

A	
Additional features	38
Aligning the motor shaft	18
Assembly notes for plug connectors	31
Assembly of plug connectors	
<i>Plug connectors</i>	
Assembly	30
Assembly of power connectors	33
B	
Before startup	42
Brake coil resistance	51
Brake control system	
<i>BMV</i>	52, 53
Brake malfunctions	44
C	
Cables	
<i>Prefabricated cables</i>	26
Cleaning	46
Connecting motor and encoders	
system via SM. plug connectors	23
Connection cable	46
Connector installation	20
Connector positions	21
Cooling air supply	18
D	
Designated use	8
Disposal	10
During startup	42
E	
Electrical connection	10, 40
Electrical installation	20
Example	
<i>Nameplate</i>	11, 13
Exclusion of liability	6
F	
Forced cooling fan	39
I	
Important notes	5
Information	
<i>Wiring</i>	22
Inspection	45
Inspection intervals	46
Installation	
<i>Electrical</i>	20
<i>Mechanical</i>	16
Installation in damp location or in the open	19
Installation tolerances	19
Installation, connector	20
Installing the motor	18
Insulation resistance	17
K	
Key to the data tables of CMP	
servo brakemotors	47
M	
Maintenance	45
<i>Cleaning</i>	46
Malfunctions	43
<i>Brake</i>	44
<i>Motor</i>	43
<i>Operation with servo inverter</i>	43
Mechanical installation	16, 39
motor installation	18
Motor protection, thermal	22
Motor/brake assignment	50
Mounting, safety notes	9
Mounting/installation	9
N	
Nameplate	11, 13
Notes	
<i>General information</i>	5
<i>Safety</i>	7
O	
Operating currents for BP brake	51
P	
Plug connectors	
<i>Assembly notes</i>	31
<i>Scope of delivery</i>	30
Power connectors	
<i>Assembly</i>	33
Prefabricated cables	26
Preliminary work	16
R	
Resistance of BP brake coils	51
Rights to claim under limited warranty	6
S	
Safety notes	7
<i>Disposal</i>	10
<i>Electrical connection</i>	10
<i>Inspection/maintenance</i>	10
<i>Mounting/installation</i>	9
<i>Startup/operation</i>	10
<i>Transportation/storage</i>	9
Scope of delivery	
<i>Plug connectors</i>	30
Serial number	13
Startup	42
Startup, safety notes	10
Storage	9
Storage, long-term	16
Structure of the synchronous CMP servomotor ..	14

**T**

Target group	8
Technical data of BP brake	
<i>Block diagram for BMV brake control</i>	52, 54
<i>Dimension sheets for BMV brake control</i>	54
Technical data of CMP motors	48
Technical data of CMP servo brakemotors	49
Technical data of the BP brake	50
Temperature sensor KTY	38
Thermal motor protection	22
Tolerances, installation	19
Tools	16
Transportation	9

U

Unit designation	12
------------------------	----

W

Wiring diagrams	27
<i>ES1H, AS1H, AK0H, EK0H encoder signal plug</i>	
<i>connector</i>	29
<i>Power plug connector</i>	27, 28
<i>RH1M resolver signal plug connector</i>	29
Wiring diagrams, connection	27
Wiring information	22

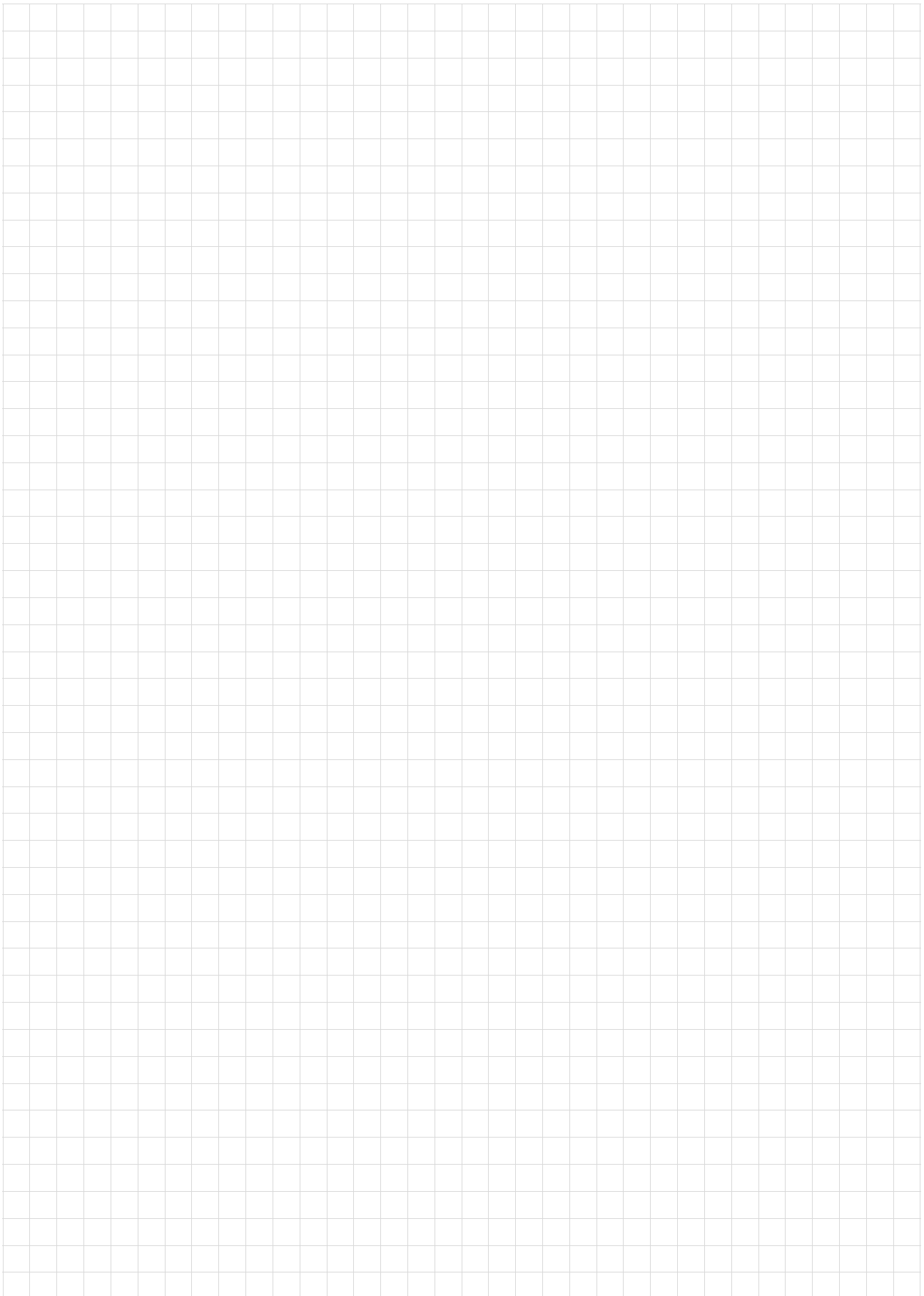

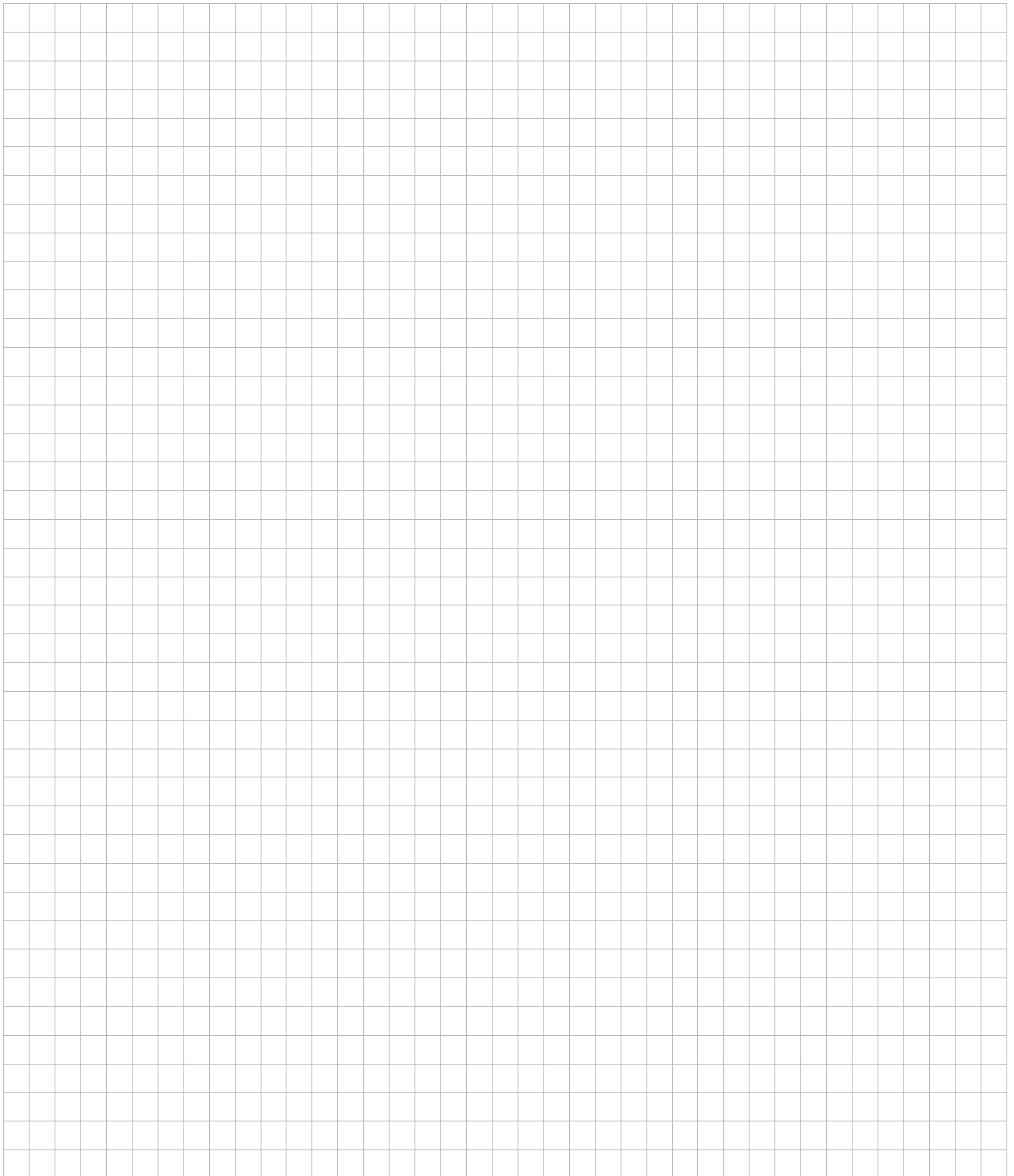

How we're driving the world

With people who think fast and develop the future with you.

With a worldwide service network that is always close at hand.

With drives and controls that automatically improve your productivity.

With comprehensive knowledge in virtually every branch of industry today.

With uncompromising quality that reduces the cost and complexity of daily operations.

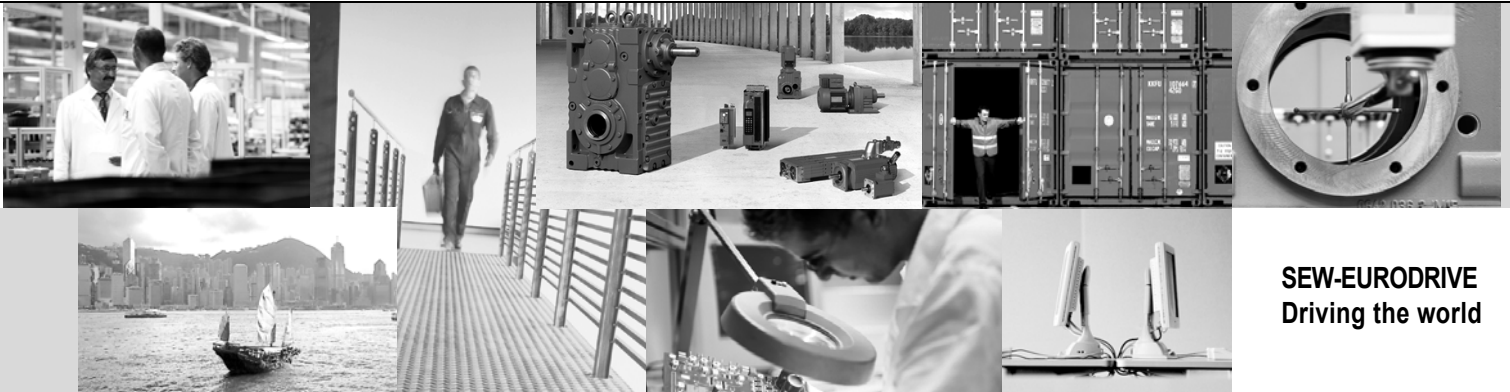

SEW-EURODRIVE
Driving the world

With a global presence that offers responsive and reliable solutions. Anywhere.

With innovative technology that solves tomorrow's problems today.

With online information and software updates, via the Internet, available around the clock.

SEW
EURODRIVE

SEW-EURODRIVE GmbH & Co KG
P.O. Box 3023 · D-76642 Bruchsal / Germany
Phone +49 7251 75-0 · Fax +49 7251 75-1970
sew@sew-eurodrive.com

→ www.sew-eurodrive.com