

# ////// ZERO-MAX<sup>®</sup>



**ETP<sup>®</sup> Keyless Shaft Mount Connections**



# ETP<sup>®</sup>

## Keyless Connections

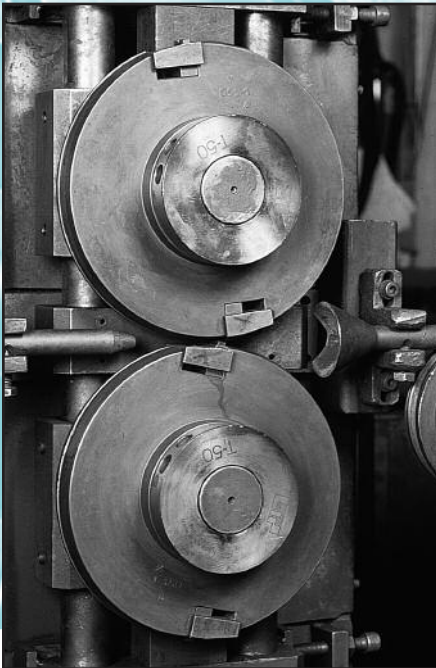
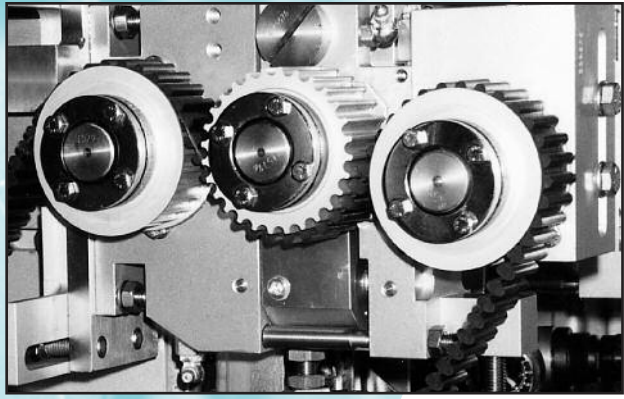

### The Ideal Locking Devices For Shaft-to-Hub Connections.

ETP Connections are ideal for positioning and locking shaft components in a system. They are the best solution where keyways and tapers can weaken or cause excess wear to the shaft components.

ETP Connections also address applications for synchronization of moving parts. They provide precision mounting of shaft components where frequent

readjusting is needed, in systems where balance and runout are inherent problems and where common fastening, adjusting and holding of shaft components are required.

There are ETP models designed to solve specific requirements such as high transmittable torque and special applications. ETP Classic and Express models are available in stainless steel for corrosion protection and to handle frequent washdowns.

### Proven Design. Easy To Use.

ETP Connections feature a double-walled sleeve and tightening mechanism. They form a solid continuous connection between shaft and hub when tightened. See specific model information for complete operating instructions.

All ETP models slide onto a shaft easily, and securely lock in position most shaft mounted motion control components. They disassemble equally fast.

# There's A Zero-Max Model For Every Application

## ETP Connection Benefits

### Provide A Solid Connection Between Shaft and Hub Without Stress or Wear to Your Components.

Eliminates keyways, tapers and tapped holes which can cause component stress and wear, due to fretting and backlash.

### Mount Shaft Components Easier, Faster and More Precisely.

All you need to do is mount, set in position and lock the ETP Connection with a torque wrench.

### Completely Adjustable.

Adjusts radially and axially. Unlike keyways which are non-adjustable, ETP Connections are infinitely phase-adjustable, making them more precise and easier to use.

### Save Space and Material.

Since it is not necessary to mill keyways in the shaft, a smaller shaft can be used, thus saving space and material.

### Reduce Component Wear and System Downtime.

May be tightened and repositioned without wear and with minimum downtime.



**ETP Classic®** Pages 4-5  
Provides the highest radial load. Has flange mounted tightening screws. Available in inch and metric sizes and stainless steel models.



**ETP Express®** Pages 6-7  
For fast and frequent mounting and dismantling. Has only one tightening screw positioned radially for easy access and space savings. Available in inch and metric sizes and stainless steel models.

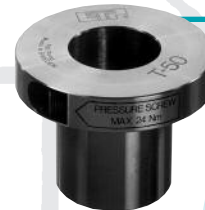

**ETP Techno®** Pages 8-9  
For high concentricity applications where frequent mountings are required. Has runout accuracy of 0.0002 inch (TIR). Handles up to 5000 mountings. Available in metric sizes.



**Posi-Lok Bushing®** Pages 10-11  
An economical solution. Features mechanical locking wedge design with corrosion protection. Available in inch and metric sizes with corrosion resistant nickel plating.

## Selection Guide and Technical Information Pages 12-13



**ETP-KN (Knifemaker)** Pages 14-15  
Use for positioning and fastening circular knives for slitting applications.

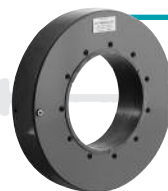

**ETP Impress®** Pages 14-15  
Hydraulic shrink connection where mounting and dismantling is done quickly and easily using hydraulic pressure. Torques up to 190,000 ft. lbs. transmittable torque.



**ETP-Hyloc®** Pages 14-15  
Hydromechanical connection. Mounting and dismantling is carried out with a hydraulic pump. Torques up to 200,000 ft. lbs.

# ETP-CLASSIC®

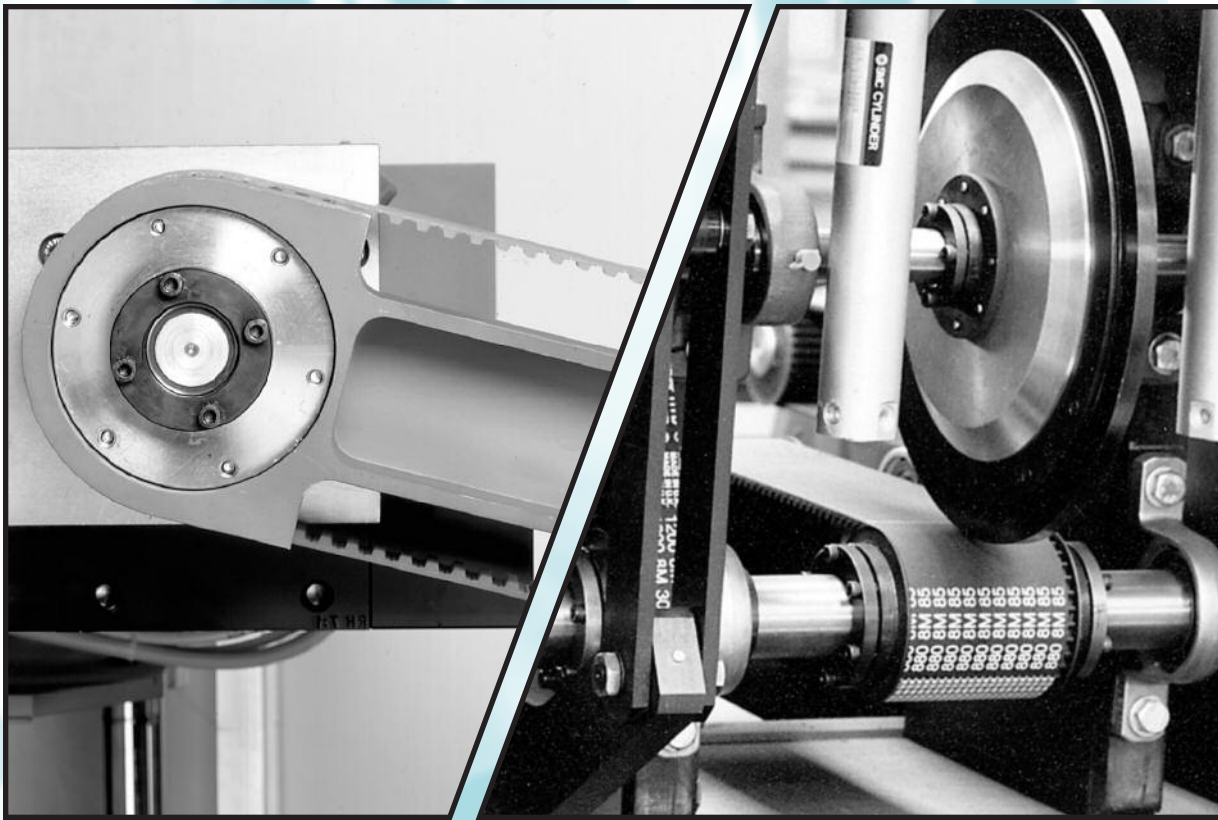

*ETP Classic provides highest radial load. Ideal for mounting timing belts, pulleys, cams, gears and other motion devices. May be positioned on and between shafts quickly with high precision. They disconnect quickly facilitating system maintenance.*

## DESIGN

ETP-CLASSIC consists of a double-walled hardened steel sleeve filled with a specially designed pressure medium, sealing ring, piston, pressure flange and clamping screws.

## OPERATION

When tightening the screws, the sleeve expands uniformly against hub and shaft and creates a rigid joint. When loosening the screws the sleeve returns to its original measurements and can easily be dismantled.

## FEATURES

- Highest radial load.
- Mounting and dismantling is fast.
- Precision adjustment of the hub can be made during mounting.
- Low tightening torque and small number of screws makes mounting easy.
- Good concentricity even after many mountings.
- Hexhead screws can also be used.
- Handles temperature range -22° F to +180° F.

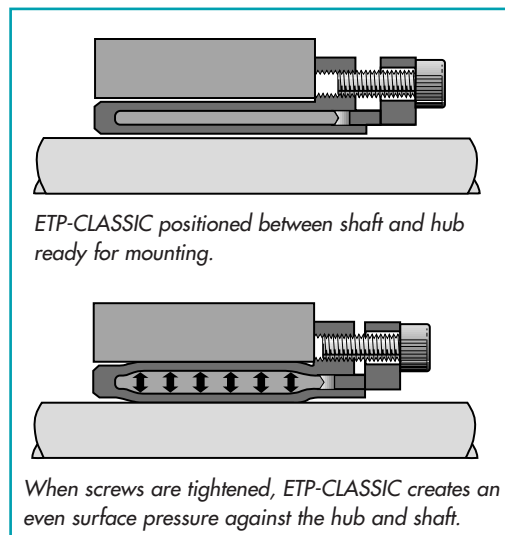

*ETP-CLASSIC positioned between shaft and hub ready for mounting.*

*When screws are tightened, ETP-CLASSIC creates an even surface pressure against the hub and shaft.*

## ETP-CLASSIC® - Inch Sizes



	d inch	D mm	D <sub>1</sub> mm	D <sub>2</sub> mm	L mm	L <sub>1</sub> mm	L <sub>2</sub> mm	T Rated ft. lbs.	F Rated lbs.	Screw Tightening torque ft. lbs.	Hex Head Size mm	No. of Screws	Weight ounces
ETP-3/4	0.75	28	45	35	21	35	40	65	2100	5.1	4	3	6
ETP-7/8	0.875	32	49	40	22	37	42	100	2700	5.9	4	4	7
ETP-15/16	0.9375	34	49	40	25	39	44	130	3300	5.9	4	4	7
ETP-1	1	35	51	41.5	27	41	46	144	3600	5.9	4	4	7
ETP-1 1/8	1.125	39	55	46	29	43	48	207	4400	5.9	4	4	9
ETP-1 3/16	1.1875	41	57	47.5	32	47	52	250	5100	5.9	4	4	10
ETP-1 1/4	1.25	43	60	50.5	34	50	55	302	5800	9.6	5	4	12
ETP-1 5/16	1.3125	45	63	52	35	52	58	350	6400	9.6	5	6	13
ETP-1 3/8	1.375	47	63	53.5	37	53	58	398	7000	5.9	4	6	14
ETP-1 7/16	1.4375	50	65	56	37	54	59	428	7100	5.9	4	6	14
ETP-1 1/2	1.5	52	68	59	41	57	62	516	9300	5.9	4	6	15
ETP-1 5/8	1.625	55	70	61	44	63	68	626	9300	5.9	4	6	19
ETP-1 11/16	1.6875	58	77	65	47	66	72	723	10300	9.6	5	6	20
ETP-1 3/4	1.75	59	77	66.5	49	67	73	870	11900	9.6	5	6	25
ETP-1 15/16	1.9375	65	83	72.5	52	74	80	1070	13100	9.6	5	6	30
ETP-2	2	68	88	76	53	74	80	1550	14400	9.6	5	6	31
ETP-2 3/16	2.1875	74	92	81	58	83	89	2068	17200	9.6	5	8	37
ETP-2 7/16	2.4375	81	99	88	60	85	91	2280	20300	9.6	5	8	41
ETP-2 1/2	2.5	84	107	93	62	86	94	2280	22000	23.6	6	6	57
ETP-2 15/16	2.9375	95	118	104	85	108	116	3925	34400	23.6	6	6	88
ETP-3	3	98	121	107	74	101	109	3925	31300	23.6	6	6	90
ETP-3 7/16	3.4375	110	132	119	90	121	129	5850	40700	23.6	6	7	113
ETP-3 15/16	3.9375	125	148	134	110	139	147	9200	59300	23.6	6	8	172
ETP-4	4.0	130	155	141	97	128	136	9200	59300	23.6	6	8	180

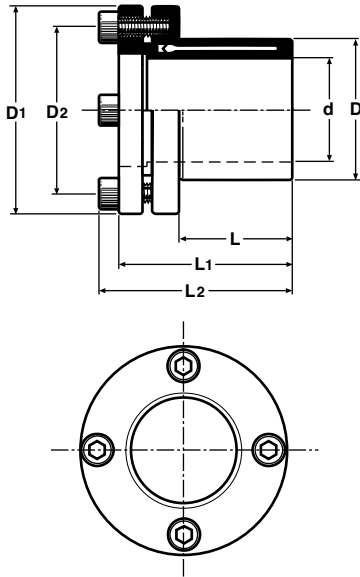

## ETP-CLASSIC® - Metric Sizes

	d mm	D mm	D <sub>1</sub> mm	D <sub>2</sub> mm	L mm	L <sub>1</sub> mm	L <sub>2</sub> mm	T Rated ft. lbs.	F Rated lbs.	Screw Tightening torque ft. lbs.	Hex Head Size mm	No. of Screws	Weight ounces
ETP-15	15	23	38	28.5	17	30	35	41	1635	3.7	4	3	4
ETP-19	19	28	45	35	21	37	42	74	2374	5.9	4	3	6
ETP-20	20	28	45	35	22	37	42	92	2800	5.9	4	3	6
ETP-22	22	32	49	40	22	37	42	100	2755	5.9	4	4	7
ETP-24	24	34	49	40	25	40	45	148	3740	5.9	4	4	7
ETP-25	25	34	49	40	27	43	48	184	4480	5.9	4	4	7
ETP-28	28	39	55	46	29	45	50	221	4793	5.9	4	4	9
ETP-30	30	41	57	47.5	32	47	52	310	6272	5.9	4	4	10
ETP-32	32	43	60	50.5	34	52	57	310	5891	5.9	4	4	12
ETP-35	35	47	63	53.5	37	55	60	479	8310	5.9	4	6	14
ETP-38	38	50	65	56	41	59	64	553	8848	5.9	4	6	15
ETP-40	40	53	70	60.5	43	63	68	693	10528	5.9	4	6	19
ETP-42	42	55	70	60.5	45	65	70	693	10035	5.9	4	6	19
ETP-45	45	59	77	66.5	49	69	75	951	12835	9.6	5	6	25
ETP-48	48	62	80	69.5	52	73	79	1158	14649	9.6	5	6	27
ETP-50	50	65	83	72.5	53	76	82	1401	17024	9.6	5	6	30
ETP-55	55	71	88	78	58	82	88	1844	20361	9.6	5	8	37
ETP-60	60	77	95	84.5	64	90	96	2508	25312	9.6	5	8	48
ETP-65	65	84	102	91	68	96	102	2581	24192	9.6	5	8	59
ETP-70	70	90	113	99	72	99	107	3835	33376	23.6	6	6	72
ETP-75	75	95	118	104	85	114	122	4646	37632	23.6	6	6	88
ETP-80	80	100	123	109	90	120	128	6490	49280	23.6	6	6	94
ETP-85	85	106	129	115	95	125	133	6490	46368	23.6	6	6	109
ETP-90	90	112	135	121	100	133	141	8112	54656	23.6	6	8	124
ETP-95	95	120	143	129	105	139	147	9440	60256	23.6	6	8	157
ETP-100	100	125	148	134	110	145	153	11431	69440	23.6	6	8	172



- All stainless steel components including clamping screws, pressure flange, piston, and double walled sleeve.
- Has the same features as the ETP Classic with a lower transmittable torque.

## ETP-CLASSIC® R - Stainless Steel Metric Sizes

	d mm	D mm	D <sub>1</sub> mm	D <sub>2</sub> mm	L mm	L <sub>1</sub> mm	L <sub>2</sub> mm	T Rated ft. lbs.	F Rated lbs.	Screw Tightening torque ft. lbs.	Hex Head Size mm	No. of Screws	Weight ounces
ETP-R15	15	23	38	28.5	17	30	34	22	1057	4	8	4	4
ETP-R20	20	28	45	35	22	37	41	66	2023	4	8	5	6
ETP-R25	25	34	49	40	27	43	46	129	3147	4	8	7	7
ETP-R30	30	41	57	47.5	32	47	51	188	3822	4	8	7	10
ETP-R35	35	47	63	53.5	37	55	59	288	5017	4	8	9	14
ETP-R40	40	53	70	60.5	43	63	67	443	6744	4	8	9	19
ETP-R45	45	59	77	66.5	49	69	73	664	8993	7	8	9	25
ETP-R50	50	65	83	72.5	53	76	80	959	11690	7	10	9	30

# ETP-EXPRESS®

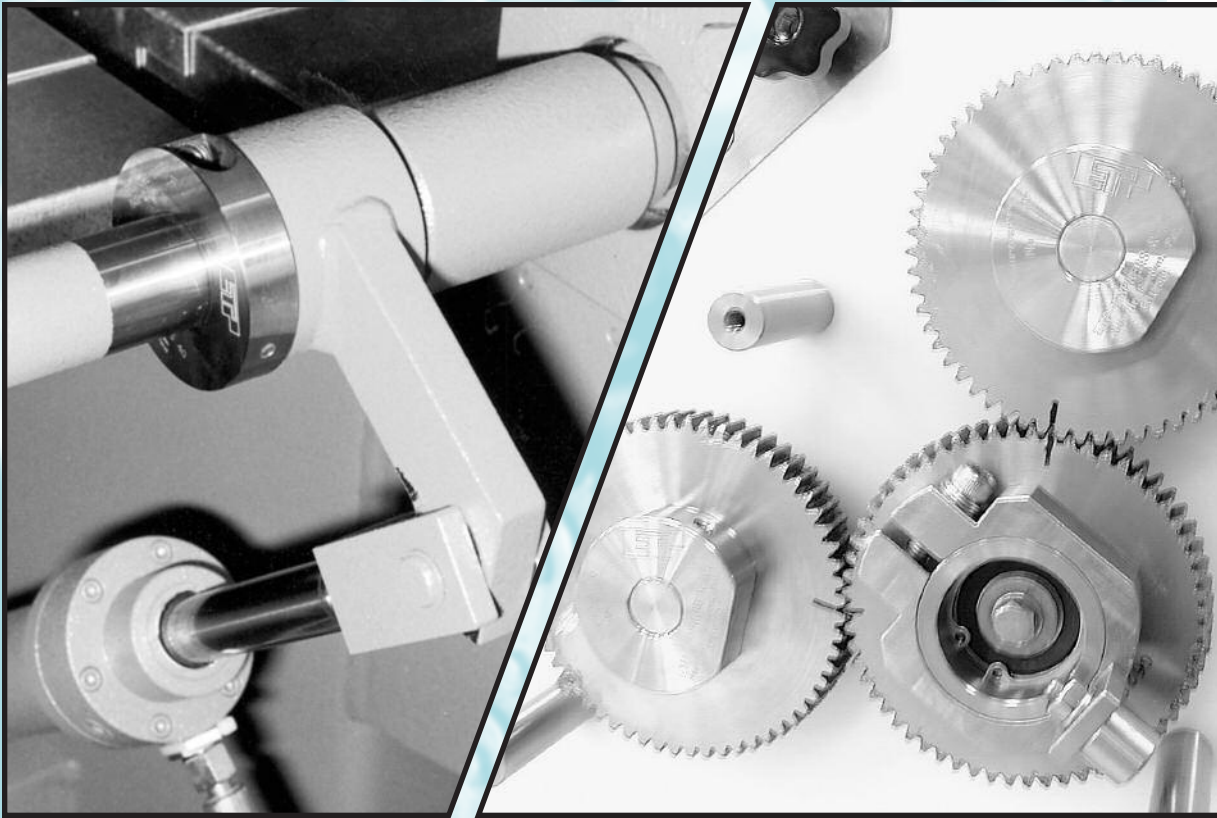

*ETP-EXPRESS has just one screw for pressurizing. It is designed for fast and accurate repositioning of the hub. Since the screw is tightened only in the radial direction, no space is used along the shaft for mounting tools. Other components can be mounted on the shaft all the way up to the flange.*

## DESIGN

ETP-EXPRESS consists of a double-walled hardened steel sleeve and flange filled with a pressure medium. The flange component has a screw and piston with seals to maintain pressure.

## OPERATION

When the pressure screw is tightened, the double-walled sleeve expands uniformly against shaft and hub and creates a rigid joint. Dismantling is done by loosening the screw which returns the ETP-EXPRESS to its original dimensions. It can then easily be dismantled.

## FEATURES

- Fast and frequent mounting/dismantling with only one screw.
- Radial screw positioning saves space along the shaft.
- Accurate positioning. No axial movement when mounting.
- Uniform surface pressure against shaft and hub prevents damage to surfaces and enables the use of small diameter hubs.
- Handles temperature range -22° F to 180° F.

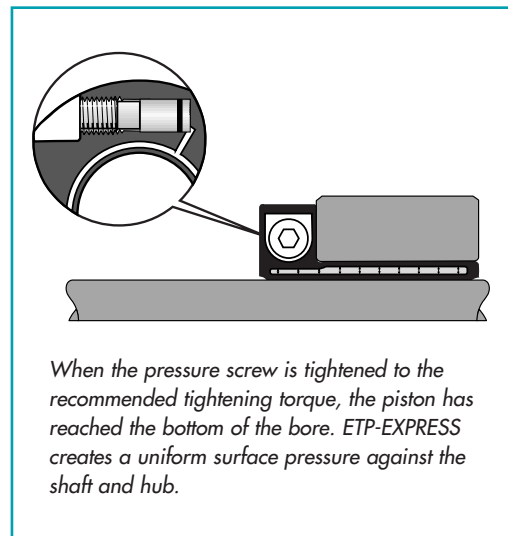

*When the pressure screw is tightened to the recommended tightening torque, the piston has reached the bottom of the bore. ETP-EXPRESS creates a uniform surface pressure against the shaft and hub.*



## ETP-EXPRESS® - Inch and Metric Sizes

	d mm	D mm	D <sub>1</sub> mm	L mm	L <sub>1</sub> mm	T Rated ft. lbs.	Axial F Rated lbs.	Screw Tightening torque ft. lbs.	Hex Head Size mm	Weight ounces
E-5/8"	15.88	19	47	26	40	39	1506	3.6	5	6
E-15	15	18	46	25	39	34	1371	3.6	5	6
E-19	19	23	50.5	28	42	63	2000	3.6	5	7
E-3/4"	19.05	23	50.5	28	42	63	2000	3.6	5	7
E-20	20	24	51.5	30	44	81	2473	3.6	5	7
E-22	22	27	55.5	32	46	96	2473	3.6	5	9
E-7/8"	22.23	27	55.5	32	46	96	2473	3.6	5	9
E-24	24	29	57.5	33	47	140	3372	3.6	5	10
E-25	25	30	58	35	49	169	4046	3.6	5	11
E-1"	25.40	31	59	35	49	140	3372	3.6	5	11
E-28	28	34	63	38	52	206	4496	3.6	5	12
E-1 1/8"	28.58	35	63.5	39	53	214	4496	3.6	5	13
E-30	30	36	64.5	40	54	280	5621	3.6	5	13
E-1 1/4"	31.75	39	68.5	42	56	317	6070	3.6	5	15
E-32	32	39	68.5	42	56	325	6070	3.6	5	15
E-1 3/8"	34.93	42	73	45	59	472	8094	3.6	5	16
E-35	35	42	73	45	59	472	8094	3.6	5	16
E-1 7/16"	36.51	44	74.5	48	62	546	7343	3.6	5	19
E-38	38	46	84.5	52	72	656	10342	15.5	8	30
E-1 1/2"	38.1	46	84.5	52	72	656	10342	15.5	8	30
E-40	40	48	86.5	55	75	811	12365	15.5	8	33
E-42	42	51	89	56	76	811	12365	15.5	8	34
E-45	45	54	93	58	78	1032	13939	15.5	8	38
E-48	48	59	97	59	79	1254	15737	15.5	8	43
E-50	50	60	98.5	60	80	1401	17086	15.5	8	43
E-2"	50.8	61	101.5	60	80	1401	17086	15.5	8	45
E-55	55	67	106	65	85	1770	19559	15.5	8	55
E-60	60	73	115.5	70	90	2434	24730	15.5	8	65
E-70	70	85	135.5	85	109	4130	35971	28.8	10	107
E-80	80	97	145.5	95	119	6416	47212	28.8	10	132

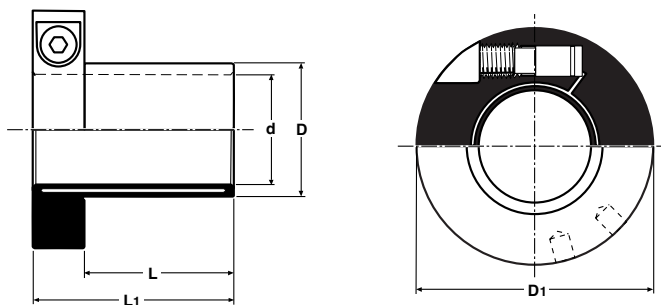

## ETP-EXPRESS® R - Stainless Steel Metric Sizes

	d mm	D mm	D <sub>1</sub> mm	L mm	L <sub>1</sub> mm	r mm	V° degrees	T Rated ft. lbs.	Axial F Rated lbs.	Radial Force lbs.	Screw Tightening Torque ft. lbs.	Hex Head Size mm	Weight ounces
ETP-ER15	15	18	46	25	39	19	53	34	1371	112	3.6	5	6
ETP-ER 5/8"	15.88	19	47	26	40	20.3	54	39	1506	112	3.6	5	7
ETP-ER 3/4"	19.05	23	50.5	28	42	21.9	55	63	2023	225	3.6	5	7
ETP-ER20	20	24	51.5	30	44	22	56	81	2473	225	3.6	5	7
ETP-ER 7/8"	22.23	27	55.5	32	46	24.4	57	95	2158	270	3.6	5	9
ETP-ER25	25	30	58	35	49	26	58	169	4046	337	3.6	5	11
ETP-ER 1"	25.4	31	59	35	49	26.1	58	140	3372	337	3.6	5	11
ETP-ER 1-1/8"	28.58	35	63.5	39	53	28.5	59	214	3595	405	3.6	5	12
ETP-ER30	30	36	64.5	40	54	28	59	280	5621	450	3.6	5	13
ETP-ER 1-1/4"	31.75	39	68.5	42	56	31.1	58	317	6097	495	3.6	5	15
ETP-ER35	35	42	73	45	59	31	58	472	8094	562	3.6	5	16
ETP-ER 1-1/2"	38.1	46	84.5	52	72	36.6	58	656	10340	630	15.5	8	30
ETP-ER40	40	48	86.5	55	75	37	59	811	12365	674	15.5	8	33
ETP-ER45	45	54	93	58	78	39.3	59	1032	13939	787	15.5	8	38
ETP-ER50	50	60	98.5	60	80	42	60	1401	17086	1012	15.5	8	43
ETP-ER 2"	50.8	61	101.5	60	80	45.2	60	1401	16635	1012	15.5	8	46
ETP-ER60	60	73	115.5	70	90	53.3	59	2434	24728	1191	15.5	8	67
ETP-ER70	70	85	135.5	85	109	62	59	4130	29225	1439	29	10	107
ETP-ER80	80	97	145.5	95	119	65.9	61	6417	40466	1686	29	10	132

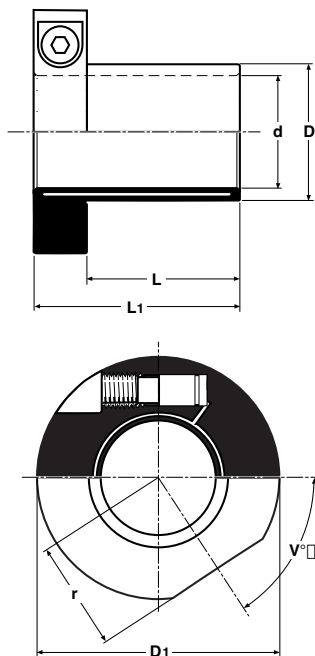

- All exposed components are made of stainless steel material.
- Operation is the same as ETP Express with the same transmittable torque.
- Easy to clean.
- Contains food grade medium.

# ETP-TECHNO®

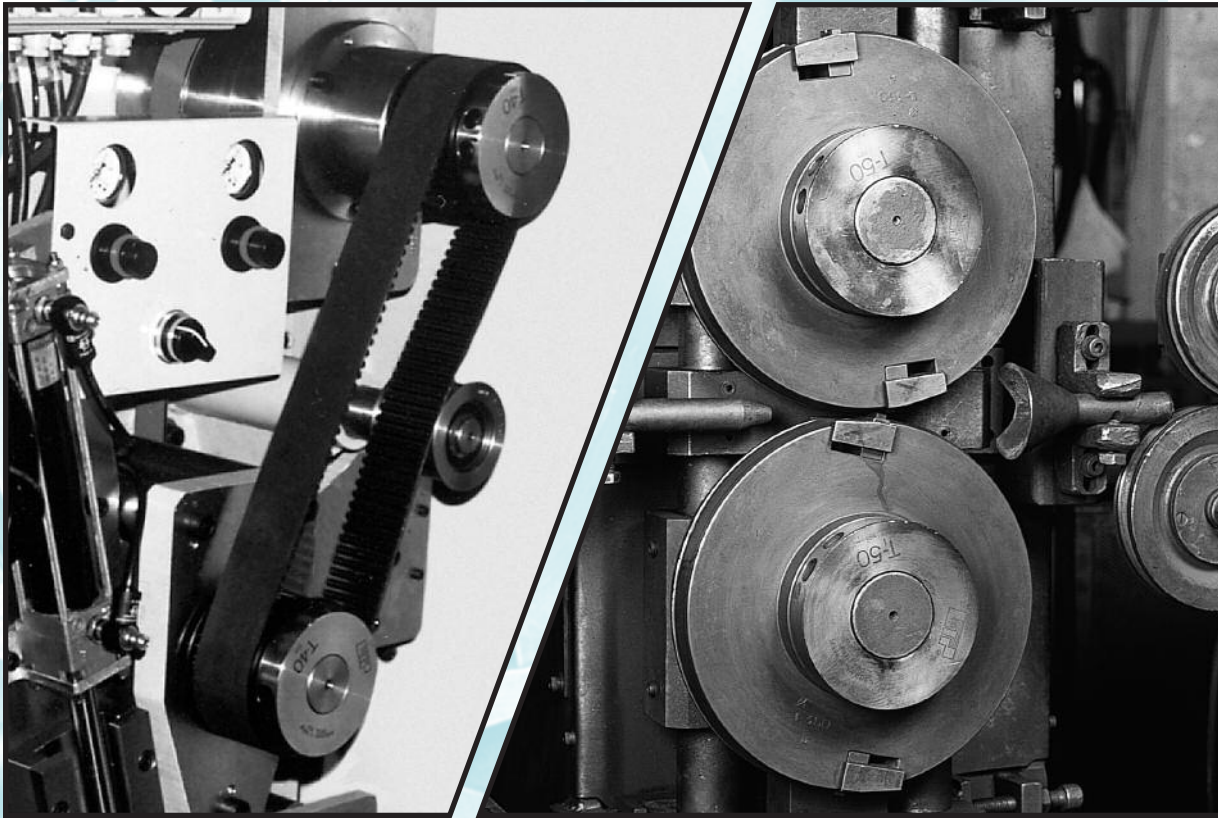

*ETP Techno is the high precision bushing among the ETP Hub-Shaft connections. It is designed for high concentricity applications where frequent mountings, and adjustments are required. Has runout accuracy of 0.0002 inch (TIR). Handles up to 5000 mountings.*

## DESIGN

ETP-TECHNO consists of a double-walled hardened steel sleeve and flange filled with a pressure medium. The flange component contains the pressurizing mechanism consisting of a screw and piston with double sealing function, an O-ring and a metallic seal with a steel ball pressed against a spherical seating element. The outer and inner diameters and the face of the flange on the hub side are accurately machined for high concentricity.

## OPERATION

When the pressure screw is tightened, the double-walled sleeve expands uniformly against the shaft and the hub creating a rigid joint. Dismantling is done by loosening the screw. ETP-TECHNO returns to its original dimensions and can easily be dismantled.

## FEATURES

- Extremely fast and easy to mount and dismantle.
- 15 popular bore sizes from 15mm to 100mm.
- Fits into tight spaces. Adjusts quickly with just one screw.
- Tightens radially with even surface pressure. Prevents damage to shaft and hub.
- Runout accuracy (TIR) 0.0002".
- Handles temperature range -22° F to 230° F.

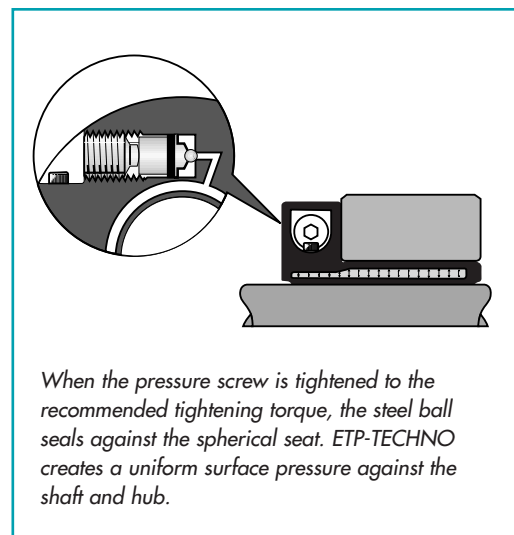

*When the pressure screw is tightened to the recommended tightening torque, the steel ball seals against the spherical seat. ETP-TECHNO creates a uniform surface pressure against the shaft and hub.*



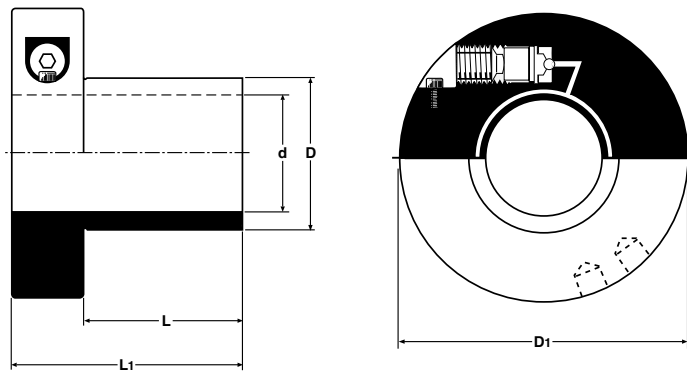

## ETP-TECHNO® High Precision Connections

	d mm	D mm	D <sub>1</sub> mm	L mm	L <sub>1</sub> mm	T Rated ft. lbs.	Axial F Rated ft. lbs.	Screw Tightening torque ft. lbs.	Hex Head Size mm	Weight ounces
T-15	15	19	52	25	41	30	1120	7	6	9
T-20	20	25	59	30	46	88	2688	7	6	11
T-25	25	32	70	35	55	214	5152	12	6	20
T-1"	25.4	32	70	35	55	214	5170	12	6	20
T-30	30	38	76	40	60	369	7392	12	6	24
T-1 1/4"	31.75	41	79	42	62	443	8318	12	6	27
T-32	32	41	79	42	62	443	8318	12	6	28
T-35	35	44	82	45	65	590	10080	12	6	30
T-1 1/2"	38.1	50	90	50	70	649	12814	18	8	38
T-40	40	52	92	55	75	885	13440	18	8	42
T-45	45	56	96	58	78	1143	15232	18	8	44
T-50	50	65	105	60	80	1475	17920	18	8	57
T-60	60	75	122	70	95	2950	29792	30	10	89
T-70	70	90	136	85	110	4794	41664	30	10	129
T-75	75	95	146	90	115	5752	46592	30	10	148
T-80	80	100	154	95	120	6638	50400	30	10	168
T-90	90	112	170	105	133	9588	64512	44	10	229
T-100	100	125	184	115	145	13275	80640	59	12	297

T is transmittable torque when axial force is 0.  
F is transmittable axial force when torque is 0.

# POSI-LOK BUSHING®

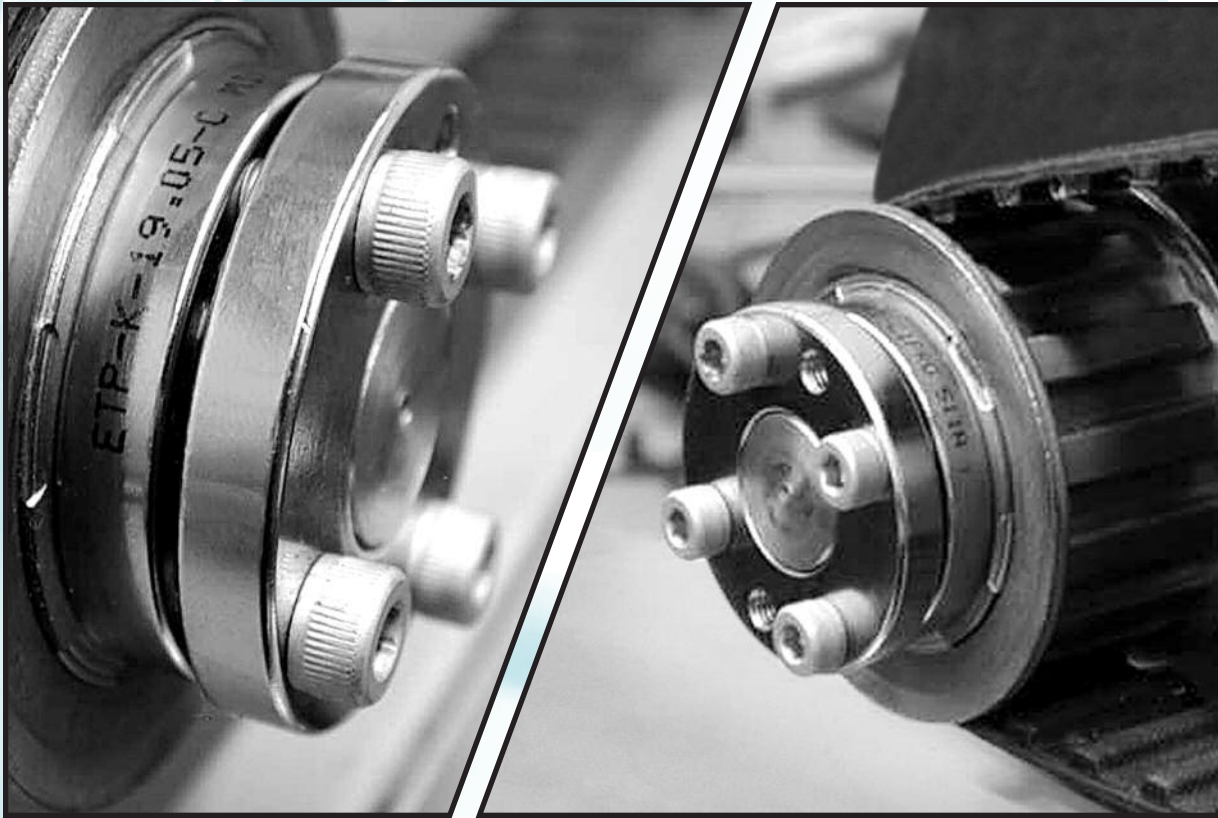

*Posi-Lok® mechanical corrosion protected connection. Posi-Lok bushing is designed to provide excellent axial and radial runout in a broad range of shaft mount applications. It features mechanical locking wedge design with nickel plated corrosion protection.*

## DESIGN

Mechanical locking wedge achieves high transmission of torque.

## OPERATION

Torquing of bolts creates a wedge effect to fasten the shaft and hub.

## FEATURES

- Provides solid connection between the shaft and mounted device. Simple, friction grip design does not require use of keyways.
- Nickel plated finish provides protection from incidental contact with salts, water, solvents and corrosion.
- Socket-head cap screws tighten quickly and easily.
- Excellent axial and radial runout.

### Mechanical locking wedge design

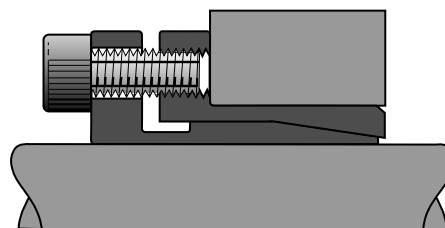

*The wedge effect is augmented by the inner sleeve groove to achieve high torque transmission.*

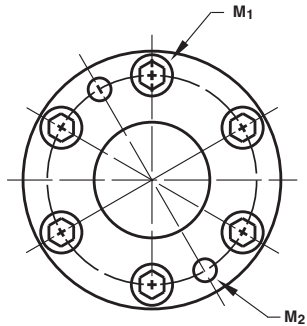
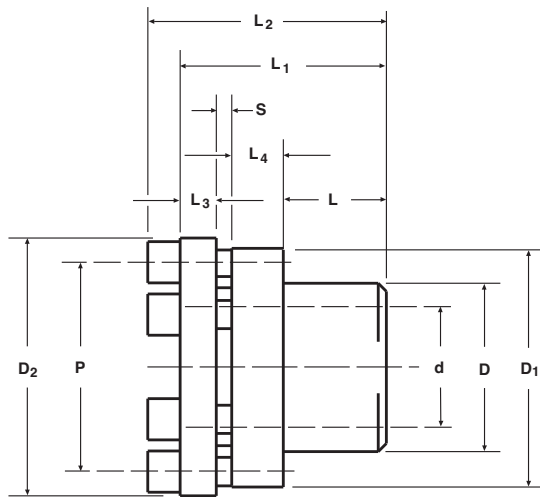

Posi-Lok Bushings® made from stainless steel are available upon request. Please contact Zero-Max at 1-800-533-1731.

## POSI-LOK® - Inch Sizes

	Maximum Transmittable Torque IN. LB.	Allowable Axial Force LBS.	Internal Hub Force PSI	External Hub Force PSI	Bolt Tightening Torque IN. LB.	Rotational Inertia WK <sup>2</sup> LB-IN <sup>2</sup>	Weight OZ.
K-1/4-C	55	438	21756	11603	18	8.54E-03	1.27
K-3/8-C	257	1326	30458	18855	35	2.60E-02	2.40
K-1/2-C	443	1753	36259	20305	35	3.42E-02	2.57
K-5/8-C	858	2855	31960	26107	71	8.54E-02	4.59
K-3/4-C	1106	2855	33359	23206	71	1.37E-01	5.43
K-7/8-C	1859	4271	36259	24656	71	2.22E-01	7.41
K-1.0-C	2124	4271	30458	23206	71	2.60E-01	7.20

	d mm	D mm	D <sub>1</sub> mm	D <sub>2</sub> mm	P mm	L mm	L <sub>1</sub> mm	L <sub>2</sub> mm	L <sub>3</sub> mm	L <sub>4</sub> mm	S mm	M <sub>1</sub> mm	M <sub>2</sub> mm
K-1/4-C	6.35	12	23	25	17	10	20	24	3.5	5	1.5	2-M4 X 8	2-M4
K-3/8-C	9.525	18	29	31	23	12	24	28	5	5	2	3-M4 X 10	3-M4
K-1/2-C	12.7	20	31	33	25	12	24	28	5	5	2	4-M4 X 10	2-M4
K-5/8-C	15.875	24	37	40	30	14	29	34	6	7	2	4-M5 X 12	2-M5
K-3/4-C	19.05	28	41	44	34	14	29	34	6	7	2	4-M5 X 12	2-M5
K-7/8-C	22.225	32	45	48	38	16	33	38	6.5	8	2.5	6-M5 X 14	2-M5
K-1.0-C	25.4	34	47	50	40	16	33	38	6.5	8	2.5	6-M5 X 14	2-M5

## POSI-LOK® - Metric Sizes

	Maximum Transmittable Torque IN. LB.	Allowable Axial Force LBS.	Internal Hub Force PSI	External Hub Force PSI	Bolt Tightening Torque IN. LB.	Rotational Inertia WK <sup>2</sup> LB-IN <sup>2</sup>	Weight OZ.
K-6-C	52	438	23206	11603	18	8.54E-03	1.31
K-7-C	60	438	18855	11603	18	8.54E-03	1.23
K-8-C	204	1326	42061	23206	35	1.71E-02	1.98
K-9-C	230	1326	37710	23206	35	1.71E-02	1.87
K-10-C	257	1326	33359	18855	35	2.63E-02	2.40
K-11-C	283	1326	30458	18855	35	2.60E-02	2.29
K-12-C	416	1753	37710	23206	35	3.42E-02	2.68
K-14-C	487	1753	31908	20305	35	4.44E-02	2.93
K-15-C	841	1753	42061	27557	71	8.20E-02	4.41
K-16-C	885	2855	39160	26107	71	9.23E-02	4.59
K-17-C	974	2855	37710	24656	71	1.13E-01	5.11
K-18-C	974	2855	34809	24656	71	1.09E-01	4.94
K-19-C	1062	2855	33359	23206	71	1.37E-01	5.47
K-20-C	1151	2855	31908	23206	71	1.33E-01	5.29
K-22-C	1859	4271	36259	24656	71	2.22E-01	7.41
K-24-C	2036	4271	33359	23206	71	2.60E-01	7.76
K-25-C	2124	4271	31908	23206	71	2.60E-01	7.41
K-28-C	3363	6070	31908	23206	124	6.94E-01	13.76
K-30-C	3540	6070	30458	21756	124	7.86E-01	14.11
K-32-C	3806	6070	27557	20305	124	8.88E-01	14.99
K-35-C	5576	8093	30458	21756	124	1.25E + 00	18.52

	d mm	D mm	D <sub>1</sub> mm	D <sub>2</sub> mm	P mm	L mm	L <sub>1</sub> mm	L <sub>2</sub> mm	L <sub>3</sub> mm	L <sub>4</sub> mm	S mm	M <sub>1</sub> mm	M <sub>2</sub> mm
K-6-C	6	12	23	25	17	10	20	24	3.5	5	1.5	2-M4 X 8	2-M4
K-7-C	7	12	23	25	17	10	20	24	3.5	5	1.5	2-M4 X 8	2-M4
K-8-C	8	15	26	28	20	12	24	28	5	5	2	3-M4 X 10	3-M4
K-9-C	9	15	26	28	20	12	24	28	5	5	2	3-M4 X 10	3-M4
K-10-C	10	18	29	31	23	12	24	28	5	5	2	3-M4 X 10	3-M4
K-11-C	11	18	29	31	23	12	24	28	5	5	2	3-M4 X 10	3-M4
K-12-C	12	20	31	33	25	12	24	28	5	5	2	4-M4 X 10	2-M4
K-14-C	14	22	33	35	27	12	24	28	5	5	2	4-M4 X 10	2-M4
K-15-C	15	23	36	39	29	14	29	34	6	7	2	4-M5 X 12	2-M5
K-16-C	16	24	37	40	30	14	29	34	6	7	2	4-M5 X 12	2-M5
K-17-C	17	26	39	42	32	14	29	34	6	7	2	4-M5 X 12	2-M5
K-18-C	18	26	39	42	32	14	29	34	6	7	2	4-M5 X 12	2-M5
K-19-C	19	28	41	44	34	14	29	34	6	7	2	4-M5 X 12	2-M5
K-20-C	20	28	41	44	34	14	29	34	6	7	2	4-M5 X 12	2-M5
K-22-C	22	32	45	48	38	16	33	38	6.5	8	2.5	6-M5 X 14	2-M5
K-24-C	24	34	47	50	40	16	33	38	6.5	8	2.5	6-M5 X 14	2-M5
K-25-C	25	34	47	50	40	16	33	38	6.5	8	2.5	6-M5 X 14	2-M5
K-28-C	28	39	59	62	47	20	39	45	7.5	9	2.5	6-M6 X 16	2-M6
K-30-C	30	41	61	64	49	20	39	45	7.5	9	2.5	6-M6 X 16	2-M6
K-32-C	32	43	63	66	51	20	39	45	7.5	9	2.5	6-M6 X 16	2-M6
K-35-C	35	47	67	70	55	22	43	49	8	10	3	8-M6 X 18	2-M6

# Selection

## On New Applications:

1. Calculate the required torque transmission rating
2. Select the ETP Connection with the proper torque rating
3. Check suitability of shaft and hub
4. Check operating temperature

## On Existing Applications:

1. Select the ETP Connection for the required shaft size
2. Check the required torque transmission rating
3. Check operating temperature
4. Check existing shaft and hub for a keyway

## Torque Calculations:

Given the horsepower rating of the prime mover and the shaft rpm, the torque transmitted is:

$$\text{Torque (lb-in)} = \frac{63025}{\text{rpm}} \times \text{H.P.}$$

$$\text{Torque (lb-ft)} = \frac{5252}{\text{rpm}} \times \text{H.P.}$$

## Calculating the Required "Tr"

The required torque transmission rating "Tr" is equal to the calculated torque multiplied by service factor "a" which will account for high starting torques, transient overloads, shock loads, pulsating loads and alternating loads.

Certain types of electric motors have starting torques as high as 2 to 2.5 times rated torque which must be taken into consideration when selecting the ETP.

Recommended service factors for various types of applications are shown in the following table:

## Service Factors

Driver Type Load	Electric Motor			Internal Combustion Engine.		
	Constant	Pulsating	Alternating	Constant	Pulsating	Alternating
Fans	1.0	-	-	1.5	-	-
Rotary Pumps	1.0	1.5	-	1.5	2.5	-
Generators	1.0	1.5	-	1.5	2.5	-
Centrifuges	-	1.5	-	-	2.5	-
Chain Drives	-	1.5	-	-	2.5	-
Reciprocating	-	-	2.0	-	-	3.0
Compressors	-	-	2.0	-	-	3.0
Piston Pumps	-	-	2.0	-	-	3.0
Conveyors (belt)	-	-	2.0	-	-	3.0
Crushers	-	-	2.0	-	-	3.0
Rolling Mills	-	-	2.0	-	-	3.0

## Example:

A piston engine powered compressor (a = 3) with a torque of 100 lb. ft. will require an ETP with a torque rating of 300 lb. ft.

The formula is:  $Tr = Tc \times a$   
**Tr** = torque rating of ETP  
**Tc** = calculating torque  
**a** = service factor

# Installation

The ETP Connection positions quickly and precisely. Simply slide bushing and hub onto shaft, tighten the clamping screws and the bushing is locked into position. To reposition the ETP Connection on the shaft, loosen screws, move the bushing to its new location and retighten screws.

A standard torque wrench is the only tool you need to install the ETP Connection.

When mounting ETP Connections over an existing keyway, the keyway must be filled in.

# Shaft and Hub Tolerances

## ETP CLASSIC (inch series) tolerances:

Sizes	Shaft	Bore
3/4"	+0.000	+0.0010
	-0.0015	-0.000
7/8"-1 1/2"	+0.000	+0.0010
	-0.0020	-0.000
1 5/8"-1 15/16"	+0.000	+0.0010
	-0.0030	-0.000
2"-4"	+0.000	+0.0014
	-0.0030	-0.000

## ETP CLASSIC (metric series) tolerances:

Shaft h8 to k6 (ETP-15 only h7)

Hub H7.

## ETP CLASSIC R tolerances:

Shaft h9 (R-15 only h8)

Hub H7.

## ETP EXPRESS and ETP EXPRESS R tolerances:

Shaft h7 for d= 15 mm.

Shaft h8 for d= 5/8", 3/4", 20, 7/8", 25, 1", 1 1/8", 30, 1 3/16", 1 1/4", 1 3/8", 35, 1 1/2", 40, 45, 50, 2", 60, 70, 80 mm.

Shaft k6-h7 for d= 19, 22, 24, 28, 32, 38, 42, 48, 55 mm.

Hub H7.

## ETP TECHNO tolerances:

Shaft h8.

Hub H7.

## POSI-LOK-K tolerances:

Shaft h8.

Hub H7.

**Note:** If the ETP Connection is used in an application where tolerances lie outside the recommended range, torque transmission (Tr) will be reduced. The torque values in the table of sizes are based on these tolerances.

## Stress in Hub and Shaft

The stress  $\sigma$  is a function of surface pressure and material thickness. At constant surface pressure,  $\sigma$  increases with diminishing material thickness. This applies both to hubs and hollow shafts.

The table below shows recommended OD/ID ratios for hubs made of different materials.

Material	OD/ID
Steel (high grade)	1.4
Steel (normal grade)	1.5
Cast Iron	2.0
Aluminum	2.5

OD = outside diameter of hub  
ID = inside diameter of hub

These OD to ID ratios allow for increased surface pressure at elevated working temperature.

## Temperature

ETP Connections are designed for use in temperatures ranging from -22°F to a maximum of +230°F depending on which product.

## Mounting Values

Following is the ETP Connection model and its rated number of potential tightening and closings.

Model	Size	Rating
ETP-CLASSIC	ALL	100
ETP-CLASSIC R	ALL	50
ETP-EXPRESS	15 mm to 35 mm	2000
	38 mm to 60 mm	1000
	70 mm to 100 mm	500
ETP-EXPRESS R	15 mm to 35 mm	800
	38 mm to 60 mm	400
	70 mm to 100 mm	200
ETP-TECHNO	15 mm to 50 mm	5000
	60 mm to 80 mm	3000
	90 mm to 100 mm	500
POSI-LOK	ALL	100

**Note One of the features of ETP connections is their ability to be mounted quickly with repeatable performance and precision. There is a limit when screws wear and require replacement. If ETP threads are cleaned and regularly lubricated, the guide values in the chart above can be used.**

Visit the Zero-Max website for additional technical information at [www.zero-max.com](http://www.zero-max.com)



## Sizing software for ETP Bushings

Zero-Max provides free software on a CD ROM to help select and size the correct ETP bushing. This CD ROM contains all Zero-Max product catalogs in a PDF format, a comprehensive sizing and selection program and CAD drawings for most of the Zero-Max products.



The sizing and selection portion of the software walks the user through the selection of any Zero-Max product and gives a recommendation on which model to use.

The software is very user friendly and can be used on any Windows or Macintosh based computer.

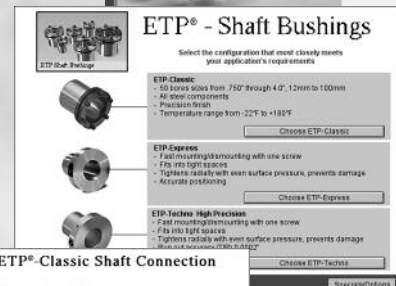
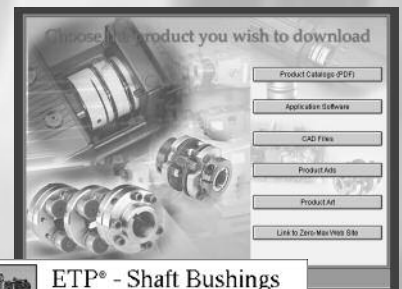

# ETP-KN (Knife Holder)

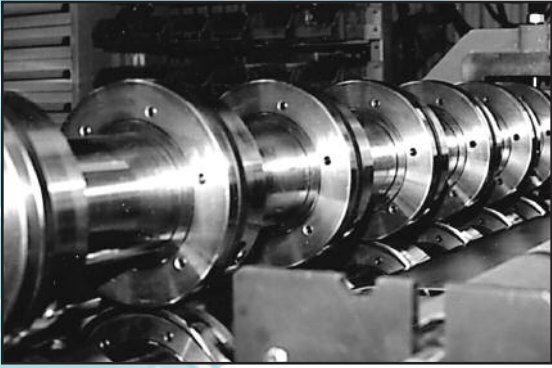

## DESIGN

The ETP-KN Knife Holder has a similar design as the ETP Techno except expansion is against the shaft only. It mounts and positions quickly and provides excellent runout and repeatability, for circular knives in slitting applications.

## OPERATION

The unique pressure chamber design of ETP-KN sets the knife accurately as the single pressure screw is tightened. ETP-KN is ideal for paper, plastic and metal slitting applications.

## FEATURES

- Repeatable axial run-out of approximately 0.0002 inch.
- Extremely short length.
- Very fast to mount, position and remove.
- Single pressure screw with low tightening torque.
- Custom designed for your application, contact Zero-Max.

# ETP-IMPRESS®

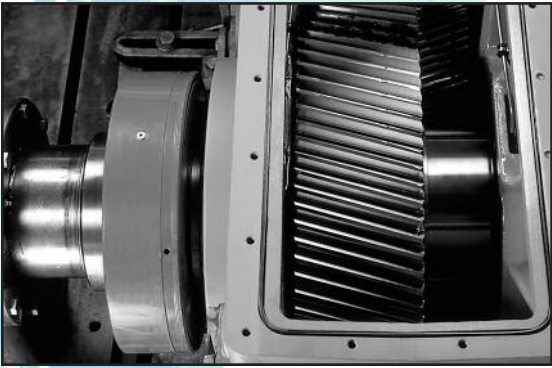

## DESIGN

The ETP Impress is a hydraulic mechanical shrink connection. Mounting is done quickly and easily using hydraulic pressure. Then axial locking screws are tightened. Hydraulic pressure is then released and the flanges stay in position held by the locking screws.

## OPERATION

ETP Impress handles up to 190,000 ft. lbs. of transmittable torque. It's ideal for applications requiring high radial force to compress conical rings and hollow shafts.

## FEATURES

- Direct relationship between hydraulic pressure and transmittable torque.
- Produces uniform surface pressure over hollow and solid shafts.
- Mounts quickly and accurately in tight places.
- The Impress connection can be loosened without hydraulic pressure.
- Can be mounted/dismantled many times without servicing.

# ETP-HYLOC®

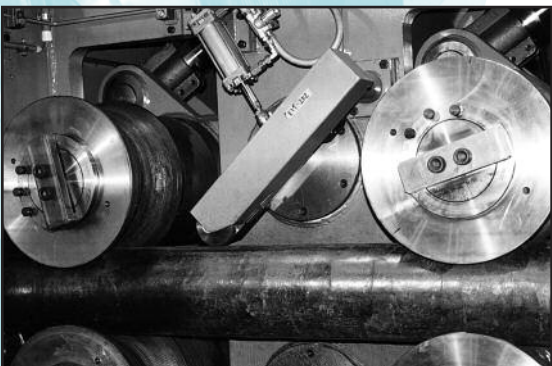

## DESIGN

The ETP Hyloc is a hydromechanical connection designed for very heavy duty applications and hostile operating environments.

## OPERATION

Double-walled sleeve encloses a conical moveable piston. Three flange-mounted threaded connections provide radial or axial hose connection.

## FEATURES

- Mounts quickly, has excellent concentricity and handles high radial loads.
- Available in bore sizes from 50 mm to 220 mm with transmittable torque to 200,000 ft. lbs.
- Mounting and dismantling is done with a hydraulic pump.

The use of the ETP-KN maintains a very tight axial alignment of the knife-edge and maximizes axial runout in the manufacture of three-piece cans. Allows for easy adjustment when changing can sizes or performing machine maintenance.

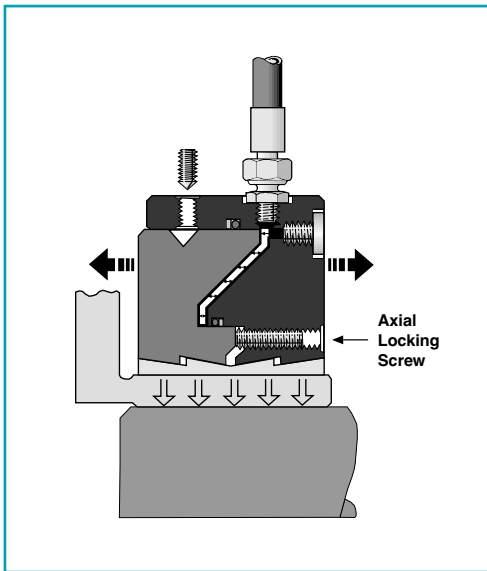
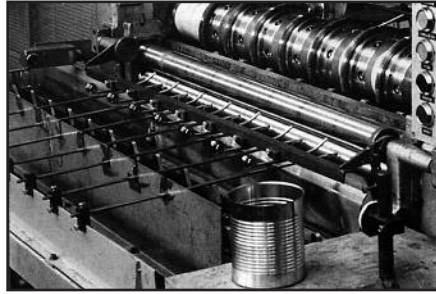
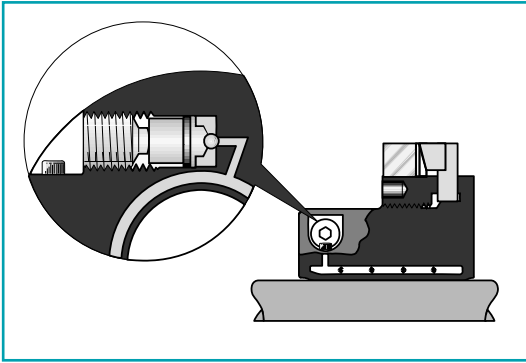

*Mounting: Apply pressure in the "ON" and "P" (not shown) connections. When mounted no hydraulic pressure remains. The small conical angle prevents the piston from releasing.*

*Dismantling: Apply pressure in the "OFF" and "P" (not shown) connections. ETP-HYLOC returns to its original measurements and the joint is loose.*



# Additional Zero-Max® Motion Control Products



## CD® Couplings

Composite disc design that outperforms steel discs and elastomeric models. Torsional stiffness. 3° misalignment. Torques to 500,000 in. lbs.

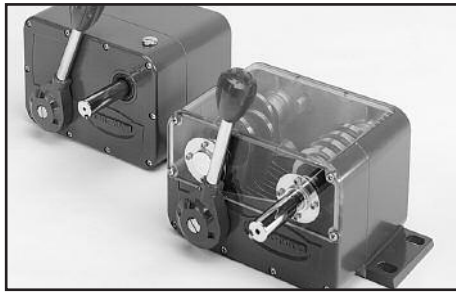

## Zero-Max® Adjustable Speed Drives

Variable 0 to 400 RPM outputs from constant input speeds to 2,000 RPM. Torques 12 to 200 in. lbs.



## Torq-Tender®

Accurate overload protection. Dis-engage torques to 3,000 in. lbs. Bores 1/8" to 1-3/4".



## Schmidt Couplings

Offset, In-line, Elastomeric and Control-Flex models. Sizes 5 to 500,000 inch lbs. torque.

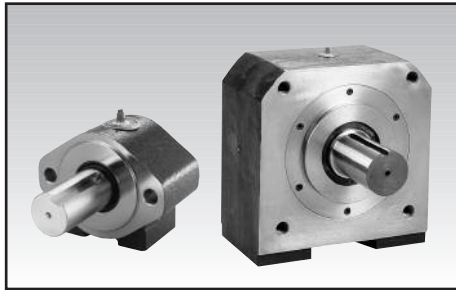

## OHLA® - Overhung Load Adapters

Overhung Load Adapters prevent failures. A thru F mounts. Keyed and spline shafts. Speeds to 3600 RPM. Specials.

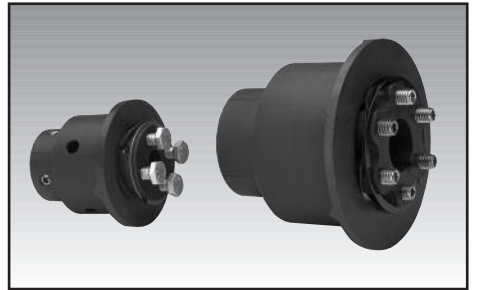

## H-TLC Torque Limiters

Corrosion proof design. Adjustable. Bores from .250" to 1.000". Torques from 4 to 500 in. lbs.

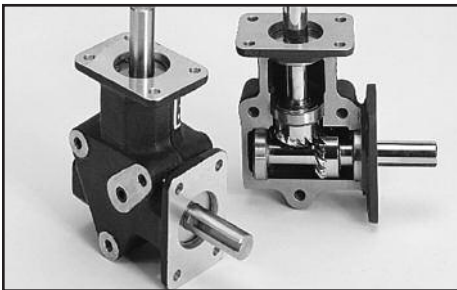

## Crown Right Angle Gear Drives

Two and three way models with 1:1 and 2:1 ratios. Spiral bevel gears. 3/8 to 1 inch dia. Stainless steel shafts.



## ServoClass® Couplings

Zero backlash, torsionally stiff, high misalignment. Clamp hubs. 8 sizes. Torques to 880 in-lb. Inch and metric bore.

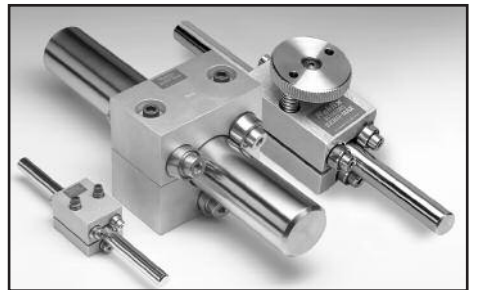

## Roh'Lix® Linear Actuators

Convert rotary motion into precise linear motion. Five models with 3/8" to 2" dia. shafts. Thrust ratings to 200 lbs. Overload protection.

## WARRANTY

Zero-Max, Inc. the manufacturer, warrants that for a period of 12 months from date of shipment it will repair, or at its option, replace any new apparatus which proves defective in material or workmanship, or which does not conform to applicable drawings and specifications approved by the manufacturer. All repairs and replacements shall be F.O.B. factory. All claims must be made in writing to the manufacturer.

In no event and under no circumstances shall manufacturer be liable for (a) damages in shipment; (b) failures or damages due to misuse, abuse, improper installation or abnormal conditions of temperature, dirt, water or corrosives; (c) failures due to operation, intentional or otherwise, above rated capacities, and (d) non-authorized expenses for removal, inspection, transportation, repair or rework. Nor shall manufacturer ever be liable for consequential and incidental damages, or in any amount greater than the purchase price of the apparatus.

Zero Max, Inc. reserves the right to discontinue models or to change specifications at any time without notice. No discontinuance or change shall create any liability on the part of Zero-Max, Inc. in respect to its products in the hands of customers or products on order not incorporating such changes even though delivered after any such change.

This warranty is in LIEU OF ALL OTHER WARRANTIES, EXPRESS OR IMPLIED, INCLUDING (BUT NOT LIMITED TO) ANY IMPLIED WARRANTIES OF MERCHANTABILITY OR FITNESS FOR A PARTICULAR PURPOSE. THE TERMS OF THIS WARRANTY CONSTITUTE ALL BUYER'S OR USER'S SOLE AND EXCLUSIVE REMEDY, AND ARE IN LIEU OF ANY RIGHT TO RECOVER FOR NEGLIGENCE, BREACH OF WARRANTY, STRICT TORT LIABILITY OR UPON ANY OTHER THEORY. Any legal proceedings arising out of the sale or use of this apparatus must be commenced within 18 months of the date of purchase.

**CAUTION:** Rotating equipment must be guarded. Also refer to OSHA specifications and recommendations.

Zero-Max®, CD®, ETP®, ServoClass®, Torq-Tender®, Control-Flex®, Posi-Lok® and Roh'Lix® are registered trademarks of Zero-Max, Inc. OHLA™ is a trademark of Zero-Max, Inc.

© Zero-Max 2006 Printed in U.S.A.

# ////// ZERO-MAX

13200 Sixth Avenue North, Plymouth, Minnesota 55441-5509  
800-533-1731 • (763) 546-4300 • Fax (763) 546-8260 • www.zero-max.com