



**marathon**<sup>®</sup>  
Motors



*Marathon Founders*

## Product Catalog

COMMERCIAL AND INDUSTRIAL SB300

1913 - 2013



A Regal Brand

**REGAL**



# Solutions for the Long Run

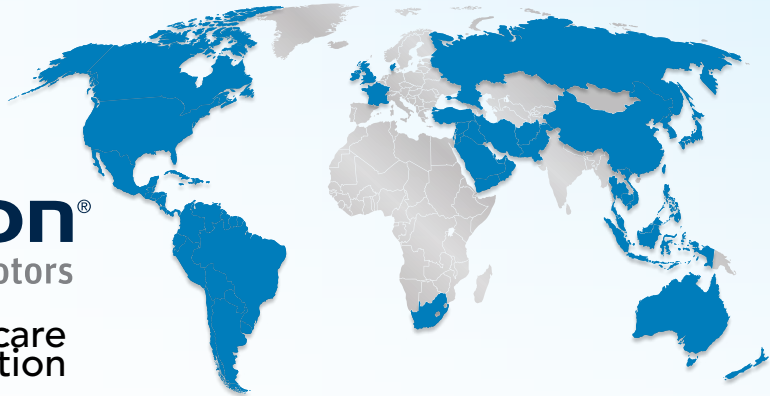

**marathon**<sup>®</sup>  
Motors

A century of customer care and innovation

100 years ago, before Marathon became a proud flagship brand in the Regal family, Marathon began manufacturing motors under four simple founding principles:

- Serve customers according to their needs
- Produce the most efficient and long-lasting motors
- Commit to new technology and research
- Expand and diversify into new markets

We still live by these core philosophies today. They are the foundation of our ability to offer sustainable, customized solutions for our valued customers.

<p><b>1913</b> Marathon company founded</p>	<p><b>1914</b> Founders design the 1/4 HP washing machine motor</p> <p><b>1918</b> Austin Kimble designs a wide variety of fans along with a product called "A drive of a million speeds"</p>	<p><b>1932</b> Producing 57,000 electric motors per year</p> <p><b>1940</b> Marathon's current plant and national headquarters is constructed</p>	<p><b>Late '40s</b> Producing over 300,000 electric motors/year</p> <p><b>MARATHON ELECTRIC</b> <small>POWER OFFICE AND FACTORY, WAUSAU, WIS. FACTORIES AT ERIE, PA. AND BOWLING GREEN, OH.</small></p> <p><b>1949</b> Purchase of generator manufacturer, Burke Electric of Erie, PA and its Bowling Green, OH fuse and terminal block division which became Marathon Special Products</p>	<p><b>1968</b> All generator production consolidated in the Wausau facilities</p> <p><b>1970s</b></p> <p><b>MARATHON ELECTRIC</b></p>	<p><b>1991</b> Marathon "fracket," a one-of-a-kind patented design for encoder and brake mounts, introduced</p> <p>BlueMAX<sup>®</sup>, the first line of inverter duty motors, introduced</p> <p>Fidelity Electric is purchased, significantly expanding Marathon's product offering of 5-20kW Pancake generators</p> <p>DVR2000, the first digital voltage regulator in the power generation industry, is introduced</p>
<p><b>1913</b> Marathon company founded</p>	<p><b>1920s</b></p> <p><b>MARATHON OK MOTORS-FANS</b></p>	<p><b>1922</b> Fractional motors and fans are trademarked as "Marathon OK"</p> <p><b>MARATHON OK PRODUCTS</b></p>	<p><b>1960</b> 1/20 HP through 3500 HP motors introduced</p> <p>Marathon motors made up 95% of the motors installed in a major Panama Canal upgrade</p> <p><b>1960s</b></p> <p><b>Marathon Electric</b></p>	<p><b>1983</b> Four-In-One motor (one stock motor capable of replacing four motors) introduced</p> <p><b>1984</b> Patented Voltage Change Device (VCD™) revolutionary design introduced for voltage change</p>	<p><b>1986</b> Generators manufactured by Marathon chosen as backups for the lighting ceremony of the Statue of Liberty</p> <p>Purchased Lima Electric, in Ohio – making Marathon the world's largest independent producer of electrical generators</p> <p>Marathon introduces XRI product line – leading the industry in NEMA Premium<sup>®</sup> efficiencies</p>

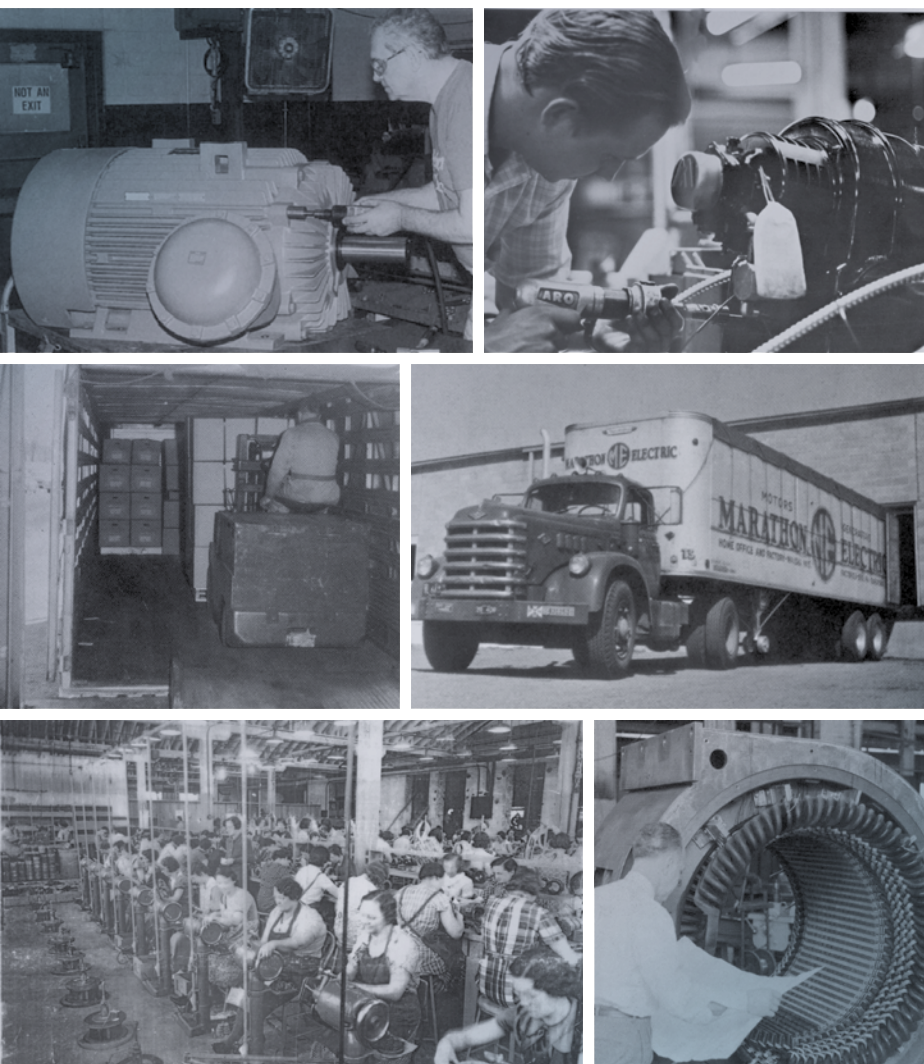

## IN THIS CATALOG

05	General Information
11	Application Information
17	Variable Speed Information
21	Single Phase
36	General Purpose Three Phase
66	Severe Duty
75	Explosion Proof
82	Medium Voltage
84	Inverter Duty "Max" Family
92	PMDC
94	IEC Motors
97	Brake Motors
99	Farm Duty / Agricultural
105	Washdown: Painted and Stainless Steel
119	Pump Motors (Fluid Handling)
155	HVAC / Air Moving
177	OEM Replacements
183	Definite Purpose
192	Modifications through MOD Central
203	Kits and Accessories
224	Index
266	Terms and Conditions

### 1996

BlackMAX® Vector Duty xpmotors introduced

Marathon Gexin joint venture established

### 1997

MAX GUARD® insulation system introduced, exceeding requirements of NEMA MG1, Part 31

Marathon Electric is acquired by Regal

### 2001

microMAX® motor awarded "Product of the Year" by Plant Engineering magazine

### 2002

First true world-class motor, IEC Globetrotter®, introduced

### 2006

Marathon adds a line of IEC motors to expand the offering and capability to compete with global demands



### 2007



### 2010

Highly efficient SyMAX™ permanent magnet AC motor introduced, making Marathon a leader in permanent-magnet motor technology

Mariner DEP/SS generator for Marine Diesel Electric Propulsion is introduced

CMG Pty Ltd is acquired by Marathon and proudly stands behind the Marathon brand

### 2013

Marathon celebrates 100 years in business



### 1998

Marathon becomes only motor company to claim unlimited lead length between motor and drive

### 1999

MagnaPOWER™ 1000 frame generator product line introduced

### 2000

Blue Chip® Severe Duty Explosion Proof motor named Plant Engineering magazine product finalist

Thomson Technology, Inc. of Vancouver, British Columbia, joins Regal allowing the company to offer a full system solution in power generation and controls

### 2004

Regal acquires the commercial AC motor division of General Electric which later rolls into Marathon's product offering

### 2005

6800 frame introduced, expanding capability to 1250 HP

Mariner line of generators for harsh duty environments introduced

### 2008

Marathon acquires motor company in China, offering motors up to 10MW and generators up to 2250 kVA

### 2011

DVR2000E+ digital voltage regulator introduced, providing easy set up

### 2012

Simplified "Marathon" becomes a flagship Regal brand

**marathon™**  
Motors

# Table of Contents

Page No.

Page No.

## General Information

Nameplate Information	5
Model number nomenclature	6
Doing business with Marathon Motors	7
Operation, Maintenance and Storage	8
Service and Warranty	9
Submittal data	9

## Application Information

Agency Information	11
Mechanical and Electrical considerations	11
Hazardous Duty™ overview	12
Terminology	15
Formulas and Conversion factors	16

## Variable Speed Information

Guidelines for general purpose motors on VFD	17
Application considerations	18

## NEMA MOTORS (AC Induction)

### General Purpose Single Phase (NEMA Service Factor)

<b>Dripproof</b>	
Rigid Base	21
Extended Thru-Bolt, Split Phase, Steel endshield	22
Rigid Base (1.0 Service Factor)	23
Resilient Base (Single and Two-Speed)	24
Resilient Base (1.0 Service Factor)	25
C-Face Footless	27
C-Face Footed (Rigid Base)	28

### Totally Enclosed

Rigid Base	29
C-Face Footless	31
C-Face Footed (Rigid Base)	32
C-Face Footed (Removable Base) - Four in One	33

### Hazardous Duty™ Division 1 Explosion Proof, Class I and II, Groups C (as noted), D, F, G

Rigid Base and Resilient Base	34
C-Face Footless and C-Face Footed (Rigid Base)	35

### General Purpose Three Phase

<b>Dripproof</b>	
Rigid Base, 50 Hz, Standard Efficiency	191
Rigid Base	36
C-Face Footless	40
C-Face Footed (Rigid Base)	41
Rigid Base, NEMA Premium® XRI® Efficiency	42
Rigid Base, NEMA Premium® Globetrotter®	45
Medium Voltage - NEMA Premium® XRI® Efficiency	86

### Totally Enclosed

Rigid Base	47
Blue Chip®, Rigid Base, Standard and EPAct Efficiencies	49
C-Face Footless	51
C-Face Footed (Rigid and Removable Base)-Four in One	53
Rigid Base, NEMA Premium® XRI® Efficiency	56
C-Face Footed (Rigid Base), NEMA Premium® XRI® Efficiency	60
Rigid Base, NEMA Premium® Globetrotter®-NEMA Efficiency	61
C-Face Footless NEMA Premium® Globetrotter®-NEMA Efficiency	64
C-Face Footed (Rigid Base), NEMA Premium® Globetrotter®-NEMA Efficiency	64

### Severe Duty

C-Face Footless / Wet Environment / Car Wash Motor	66
Blue Chip® Severe Duty, Rigid Base	66
Blue Chip® Severe Duty, Rigid Base, NEMA Premium® XRI® Efficiency	67

Blue Chip® Severe Duty IEEE-841, Rigid Base, NEMA Premium® XRI® Efficiency	71
Medium Voltage - NEMA Premium® XRI® Efficiency	82

## Explosion Proof

Blue Chip® Severe Duty, C-Face Footed (Rigid Base)	75
Hazardous Duty™, Division 1 Explosion Proof, Class I and II, Groups C (as noted), D, F, G	
Steel frame, Rigid Base	76
C-Face Footless, Standard and EPAct Efficiency	77
Blue Chip® Severe Duty, Rigid Base, EPAct Efficiency	78
Blue Chip® Severe Duty, Rigid Base, NEMA Premium® XRI® Efficiency	79
Black Max® Vector Duty Explosion Proof, C-Face Footed (Rigid Base)	87
Blue Max® Vector Duty Explosion Proof with Encoder, C-Face Footed (Rigid Base)	89
Hazardous Duty™, Division 2/Zone 2	
Totally Enclosed, Class I	
Blue Chip®, Severe Duty, Rigid Base, NEMA Premium® XRI® Efficiency	67
Blue Chip® Severe Duty IEEE-841, Rigid Base, NEMA Premium® XRI® Efficiency	71
Medium Voltage	82

## Inverter (Vector) Duty: "MAX"-series

<b>AC Variable Speed motors</b>	
microMAX® Totally Enclosed, C-Face Footless and C-Face Footed (Rigid Base)	84
Max-Plus (with Encoder), Totally Enclosed, C-Face Footed (Rigid Base)	85
Black Max® Totally Enclosed, C-face Footed (Rigid Base)	86
Blue Max® Totally Enclosed, Rigid Base and C-Face Footed (Rigid Base)	88
Black Max® Explosion Proof, C-Face Footed (Rigid Base)	87
Blue Max® Explosion Proof, with Encoder, C-Face Footed (Rigid Base)	89
Blue Max® Brakemotor, Totally Enclosed, C-Face Footed (Rigid Base)	90
SyMAX PMAC	91

## Permanent Magnet DC

SCR Rated, Totally Enclosed, C-Face Footed (Removable Base)	92
Washdown, SCR Rated, Totally Enclosed, C-Face Footed (Removable Base)	93
Low Voltage, Totally Enclosed, C-Face Footed (Removable Base)	93

## IEC METRIC MOTORS (AC Induction)

<b>Totally Enclosed</b>	
Globetrotter® - B3 mount	94
Globetrotter® - B14 and B35 (flange) mount	96
Flange Kits	208

## Brakemotors

Single Phase, Totally Enclosed, C-Face Footed (Removable Base)	97
Three Phase, Totally Enclosed, Rigid Base	97
Three Phase, Totally Enclosed, C-Face Footless	97
Three Phase, Totally Enclosed, C-Face Footed (Removable Base)	98
Blue Max® Vector Duty Brakemotor, C-Face Footed (Rigid Base)	90
Brake kits: Four-in-One and Black Max®	209

# Table of Contents

	Page No.		Page No.
<b>Farm Duty / Agricultural</b>			
Aeration Fan, Single Phase, TEAO, Rigid Base (see HVAC/Air Moving section) . . . . .	155	Fan & Blower - Direct Drive, PSC, Open Air Over, Extended Thru-Bolt, 460 Volt . . . . .	163
Fan - Single Phase Capacitor Start, TEAO, Rigid Base - High Efficiency . . . . .	100	Fan & Blower - Direct Drive, PSC, Open Air Over, Torsion Flex mount . . . . .	163
Fan - Single Phase, TEAO, Resilient Base-Thru Bolt . . . . .	102	Fan & Blower - Direct Drive, PSC, Open Air Over, Belly Band Thru-Bolt, Double Shaft . . . . .	164
Fan - PSC, TEAO, Resilient Base-Thru Bolt - Variable Speed . . . . .	101	Fan & Blower - Split Phase, Dripproof, Resilient Base - Single and Two Speed . . . . .	165
Fan - Single Phase, TEAO, Direct Drive-Thru Bolt - Single and Two Speed . . . . .	104	Fan & Blower - Capacitor Start, Dripproof, Resilient Base - Single and Two Speed . . . . .	167
High Torque, Single Phase, TEFC, Rigid Base . . . . .	99	Fan & Blower - Split Phase and Capacitor Start, Totally Enclosed, Resilient Base - Single and Two Speed . . . . .	168
High Torque, Single Phase, TEFC, C-Face Footed (Rigid Base) . . . . .	99	Fan & Blower - Single Phase, Explosion Proof, Resilient Base . . . . .	34
Extra-High Torque Chore Motor®, Single Phase, TEFC, Rigid Base . . . . .	100	Fan & Blower - Three Phase, Dripproof, Resilient Base - Single and Two Speed . . . . .	169
Auger Drive, Single Phase, TEFC, N-Flange . . . . .	100	Fan & Blower - Three Phase, TEAO, Resilient Base . . . . .	153
Crop Dryer, Single Phase, Dripproof/Air Over, Rigid Base . . . . .	103	<b>Furnace Blower (see Fan &amp; Blower motors)</b>	
Crop Dryer, Three Phase, Dripproof/Air Over, Rigid Base . . . . .	103	Furnace Blower - PDQ mount . . . . .	170
Grain Stirring, Single Phase, TEFC, Rigid Base . . . . .	103	Kiln Duty . . . . .	187
Incubator/Hatchery Vent Fan, PSC, TEAO, Thru-Bolt . . . . .	104	ME-CAN-DO (Multi-Horsepower), Condenser Fan, PSC, TEAO, Thru-Bolt . . . . .	175
Center Pivot Irrigation, Three Phase, TEFC, with Drip Cover . . . . .	104	ME-CAN-DO (Multi-Horsepower), Fan & Blower - Direct Drive, PSC, Open Air Over, Resilient Ring, Thru-Bolt . . . . .	176
<b>HVAC motors (Air Moving)</b>			
Aeration Fan (see also Farm/Ag Duty) . . . . .	155	Two-Speed, One-Winding and Two-Winding, Variable Torque, Three Phase, Dripproof, Rigid Base . . . . .	185
Attic Fan . . . . .	155	Oil Burner, PSC, 48M flange mount . . . . .	171
Centrifugal Fan . . . . .	156	Oil Burner, Split Phase and Capacitor Start, 48M and 48N flange mount . . . . .	171
Circulator Pump, Single Phase, Dripproof - see also Pump/Fluid Handling section . . . . .	174	Oil Burner, Split Phase and Capacitor Start, 56C Footless . . . . .	172
Condenser Fan/Heat Pump, "ME-CAN-DO" multi-horsepower . . . . .	175	Oil Burner, Three Phase, C-Face Footless (see also Centrifugal Pump, Three Phase) . . . . .	172
Condenser Fan/Heat Pump, PSC, Dripproof, Resilient Ring, Thru-Bolt . . . . .	159	Pedestal Fan, PSC, TEAO, Yoke Mount . . . . .	167
Condenser Fan/Heat Pump, PSC, Open Air Over, Thru-Bolt, Shaft Up or Horizontal . . . . .	156	Refrigeration Fan - Single Phase . . . . .	182
Condenser Fan/Heat Pump, PSC, Open Air Over, Thru-Bolt, Shaft Down . . . . .	157	Refrigeration Fan - Three Phase (see also Condenser Fan/Heat Pump, Three Phase) . . . . .	173
Condenser Fan/Heat Pump, PSC, Open Air Over, Thru-Bolt, All-Angle . . . . .	158	Transformer Cooling Fan, TEAO, Single Speed, Rigid Base . . . . .	173
Condenser Fan/Heat Pump, PSC, Open Air Over, Resilient Ring, Thru-Bolt . . . . .	159	Unit Heater Fan, PSC, TEAO, Resilient Base . . . . .	174
Condenser Fan/Heat Pump, PSC, Open Air Over, Rigid Base, Shaft Up or Horizontal . . . . .	158	<b>OEM replacement aftermarket motors . . . . . 174</b>	
Condenser Fan/Heat Pump, Three Phase, Open Air Over, Belly Band/Resilient Ring, Shaft Up or Horizontal . . . . .	161	<b>Definite Purpose Motors</b>	
Commercial Condenser Fan/Heat Pump, PSC, Open Air Over, Belly Band, Shaft Up . . . . .	159	<b>Air Compressor . . . . . 183</b>	
Commercial Condenser Fan/Heat Pump, PSC, Resilient Base, Shaft Up or Horizontal . . . . .	160	<b>Automotive Duty</b>	
Commercial Condenser Fan/Heat Pump, Three Phase, Dripproof, Belly Band, Shaft Up . . . . .	160	T-Frame: GM 7E-TA (Blue Chip® Severe Duty IEEE-841, Rigid Base, NEMA Premium® XRI® . . . . . 74	
Exhaust Ventilator, Single Phase, Dripproof, C-Face Footless - Single and Two Speed . . . . .	170	T-Frame: Ford EM-1 (Blue Chip®, Severe Duty, Rigid Base, NEMA Premium® XRI® . . . . . 69	
Exhaust Ventilator, Single Phase, Explosion Proof, C-Face Footless . . . . .	35	<b>Car Wash</b>	
Fan & Blower - Direct Drive, ME-CAN-DO mutli-horsepower . . . . .	175	Blue Chip® Severe Duty, C-Face Footless w/ SS Shaft . . . . . 66	
Fan & Blower - Direct Drive, PSC, Open Air Over, Resilient Ring . . . . .	164	<b>Cooling Tower</b>	
Fan & Blower - Direct Drive, PSC, Open Air Over, Resilient Ring, Thru-Bolt mount . . . . .	162	Single-Speed, Blue Chip® Severe Duty, Three Phase, Totally Enclosed, Rigid Base . . . . . 68	
		Two-Speed, Blue Chip® XRI® Severe Duty, Three Phase, Totally Enclosed, Rigid Base . . . . . 184	
		<b>Instant Reversing</b>	
		Single Phase Capacitor Start and PSC, Dripproof and Totally Enclosed . . . . . 186	
		<b>Kiln Duty . . . . . 187</b>	
		<b>Multi-Speed</b>	
		Two-Speed, One-Winding and Two-Winding, Variable Torque, Three Phase, Dripproof, Rigid Base . . . . . 185	

# Table of Contents

	Page No.		Page No.
<b>Oil Well Pump</b> .....	188	PowerWash™ XT Washdown Duty, Single Phase, C-Face Footless .....	105
<b>Pressure Washer</b>		PowerWash™ Washdown Duty, Single Phase, C-Face Footed (Rigid Base) .....	105
Single Phase, Dripproof, Rigid Base and C-Face Footed (Rigid Base) .....	189	PowerWash™ XT Washdown Duty, Three Phase, Rigid Base .....	106
Single Phase, Totally Enclosed, Rigid Base and C-Face Footed (Rigid Base) .....	190	PowerWash™ XT Washdown Duty, Three Phase, C-Face Footless .....	107
<b>Pump motors (Fluid Handling)</b>		PowerWash™ XT Washdown Duty, Three Phase, C-Face Footed (Rigid Base) .....	108
Carbonator Pump, Split Phase, Dripproof .....	119	PowerWash™ XT Washdown Duty Close Coupled Pump, JM, Rigid Base .....	109
Centrifugal Pump (Jet Pump), Single Phase, Dripproof, C-Face Footless, 56C/56J .....	120	PowerWash™ XT Washdown Duty Centrifugal Pump (Jet Pump), C-Face Footless, 56J .....	109
Centrifugal Pump (Jet Pump), Single Phase, Dripproof, C-Face Footed (Rigid Base), 56J .....	121	PowerWash™ XT Washdown Duty Centrifugal Pump (Jet Pump), C-Face Footed, 56J .....	109
Centrifugal Pump (Jet Pump), Single Phase, Totally Enclosed, C-Face Footless, 56C/56J .....	121	PowerWash™ XT Washdown Duty Brakemotor C-Face Footed and Footless .....	109
Centrifugal Pump (Jet Pump), Three Phase, Dripproof, C-Face Footless, 56C/56J .....	122	PowerWash™ SXT Washdown Duty, Single Phase, C-Face Footed (Rigid Base) .....	110
Centrifugal Pump (Jet Pump), Three Phase, Dripproof, C-Face Footed (Rigid Base), 56J .....	122	PowerWash™ SXT Washdown Duty, Three Phase, Stainless, C-Face Footless .....	111
Centrifugal Pump (Jet Pump), Three Phase, Totally Enclosed, C-Face footed (Removable Base), 56J .....	123	PowerWash™ SXT Washdown Duty, Three Phase, Stainless, C-Face Footed (Rigid Base) .....	112
Circulator Pump, Single Phase, Dripproof - see also HVAC/Air Moving section .....	174	PowerWash™ SXT PLUS Washdown Duty, Single Phase, Stainless/BISSC, C-Face Footless .....	113
Close Coupled Pump, JM, Single Phase, Dripproof, C-Face Footed (Rigid Base) .....	124	PowerWash™ SXT Washdown Duty, Single Phase, C-Face Footed (Rigid Base) .....	113
Close Coupled Pump, JM, Single Phase, Totally Enclosed, C-Face Footed (Rigid Base) .....	124	PowerWash™ SXT Washdown Duty, Three Phase, Stainless/BISSC, C-Face Footless .....	114
Close Couple Pump, JM, Three Phase, Dripproof, C-Face Footed NEMA Premium® Globetrotter®- NEMA Efficiency .....	129	PowerWash™ SXT PLUS Washdown Duty, Three Phase, Stainless/BISSC, C-Face Footed (Rigid Base) .....	115
Close Coupled Pump, JM, Three Phase, Dripproof, C-Face Footless (Vertical) and C-Face Footed (Rigid Base) .....	125	PowerWash™ SXT PLUS Washdown Duty, Three Phase, Closes Couple Pump JM (Rigid Base) .....	116
Close Coupled Pump, JM, Three Phase, Totally Enclosed, C-Face Footed (Rigid Base) .....	131	PowerWash™ SXT PLUS Washdown Duty, Three Phase, C-Face Footed (Rigid Base) Brake Motor .....	116
Close Coupled Pump, JP, Single Phase, Dripproof, C-Face Footed (Rigid Base) .....	132	PowerWash™ SXT PLUS Washdown Duty, Three Phase, C-Face Footed (Rigid Base) IEC .....	117
Close Couple Pump, JM, Three Phase, Totally Enclosed, C-Face Footed NEMA Premium® Globetrotter®- NEMA Efficiency .....	133	PowerWash™ SXT PLUS Washdown Duty, Three Phase, Stainless/BISSC, C-Face Footless .....	118
Close Coupled Pump, JP, Three Phase, Dripproof, C-Face Footless (Vertical) and C-Face Footed (Rigid Base) .....	135	PowerWash™ SXT PLUS Washdown Duty, Three Phase, Stainless/BISSC, C-Face Footed (Rigid Base) .....	118
Close Coupled Pump, JP, Three Phase, Totally Enclosed, C-Face Footed (Rigid Base) .....	138	<b>Woodworking/Power Tool</b> .....	191
Close Couple Pump, JP, Three Phase, Dripproof, C-Face Footed NEMA Premium® Globetrotter®- NEMA Efficiency .....	139	<b>50 Hertz</b> .....	191
Close Couple Pump, JP, Three Phase, TEFC, C-Face Footed NEMA Premium® Globetrotter®- NEMA Efficiency .....	141	Modifications through MOD Central .....	192
Fire Pump, Three Phase, Dripproof, Rigid Base .....	144	<b>Accessory Kits</b> .....	203
Fire Pump, Three Phase, TEFC, Rigid Base .....	146	<b>"Specials are our Specialty"</b> .....	222
Jet Pump (single compartment)-See Centrifugal Pump .....	121	<b>Index</b> .....	
Jet Pump, Two-Compartment, Single Phase, Dripproof, C-Face Footless, 56C/56J .....	120	Catalog to Model Number .....	224
Jet Pump, Two-Compartment, Single Phase, Dripproof, Square Flange .....	120	Model to Catalog Number .....	248
Oil Well Pump .....	188	<b>Terms and Conditions of Sale</b> .....	266
Sump Pump, Split Phase, Dripproof .....	120	<b>Warnings and Cautions</b> .....	268
Vertical Solid Shaft P-Base, Three Phase, Dripproof .....	149	<b>EISA - Frequently Asked Questions</b> .....	269
Vertical Solid Shaft P-Base, Three Phase, Totally Enclosed ..	152	<b>NEMA MG-1 Table 12-11 EPAct Efficiencies</b> .....	270
<b>Washdown - Painted and Stainless Steel</b>		<b>NEMA MG-1 Table 12-12 NEMA Premium® Efficiencies</b> .....	271
PowerWash™ XT Washdown Duty, Single Phase, Rigid Base .....	105	One Regal .....	272
		<b>Footnotes</b> .....	Flip Out
		<b>Blue Chip® Product Line Comparison</b> .....	IBC
		<b>IEC Quick Reference Dimensional Chart</b> .....	Flip Out

# General Information

## MARATHON MOTORS

Since 1913, Marathon Motors's name has been recognized for engineering excellence, custom-designed products and an extensive product line of industrial quality motors. Available in all popular enclosures from 1/12 HP through 3000 HP and in a variety of mounting configurations, Marathon Motors's unique designs provide more ways in which to add accessories, such as blowers, brakes and encoders, to our motors than anyone else in the motor business. Our state-of-the-art lab facilities are equipped and staffed with the finest resources available to ensure successful utilization of our products. Finally, as the preferred supplier of motors to most of the top drive manufacturers in North America, we have what it takes to be a leader in understanding the interaction of drives as they are applied with AC induction motors.

## WEBSITE AND E-COMMERCE

Information can be accessed instantly, any time of the day on ME-business. Marathon customers can sign-up for ME-business by contacting their sales representative.

ME-business can be accessed through: [www.marathonelectric.com](http://www.marathonelectric.com).

- Stock Availability
- Order Status
- Shipping Information
- Invoice Information
- Product features and performance data



## Marathon Motors Nameplate Information - HOW TO READ THE NAMEPLATE

The nameplate is the key to selecting the proper replacement motor.

**marathon** Motors  
WAUSAU, WISCONSIN 54401 U.S.A.

**XRI** HIGH EFFICIENCY

CSA Verification Mark - Complies with CSA's Energy Efficiency Verification Service and their Standard C390 - C390 is the Canadian efficiency equivalent of EPAct.

Underwriters Laboratories, Inc. UL Recognized Component Mark  
UL file # E49747

CE (Conformité Européene) Marking  
This mark signifies the motor complies with the European Low Voltage Directive.

CSA Mark - Certified by the Canadian Standards Association  
CSA file # LR21839

CC# - Compliance Certification Number as per assigned by the Department of Energy. Motors meeting EPAct efficiencies or higher will have this number.

Motor Specifications (Example)

Agency Symbols

- MODEL** - The ID number
- DATE CODE** - The month and year manufactured
- MTG.** - Mounting
- FRAME** - The size & mounting
- PART NO.** - Customer part number
- SER.** - Serial number
- TYPE** - Electrical type
- DES.** - Code by NEMA or IEC
- PH** - Electrical phase usually 1 or 3
- INS CL** - Insulation Class
- DUTY** - Time rating under load
- MAX AMB** - The allowable surrounding air temperature
- ENCL** - Enclosure (i.e. TEFC)
- RISE** - The temperature rise over ambient expressed in degrees Celsius when the motor operates at nameplated HP or KW
- IP** - Inherent Protection of the enclosure to solids and liquids as defined by IEC 34-5
- IC** - Inherent Cooling
- CODE** - NEMA locked-rotor KVA
- MTH/YR MFG.** - Month and year motor was manufactured
- WT/LBS** - Motor weight in pounds
- WT/KG** - Motor weight in kilograms
- HZ** - Input frequency of the power supply, usually 50 or 60 HZ
- VOLTS** - Voltage rating of the motor at the operating frequency
- HP** - Rated horsepower the motor will produce
- KW** - Rated output in watts
- F.L. AMPS** - The rated load current expressed in amps at nameplated horsepower with nameplate voltage and frequency
- S.F.** - Percentage of the rated horsepower the motor can safely operate at: Example: 1.15 SF (115% of rated HP)
- PF / COS** - Power Factor / Cosine is the ratio of actual power to the apparent power
- RPM** - Full load speed at rated frequency
- NOM EFF** - Average Efficiency
- SHAFT END BEARING** - Manufacturer drive end bearing number
- OPP. END BEARING** - Manufacturer opposite drive end bearing number
- SHAFT END BRG** - Drive end bearing size
- OPP** - Opposite drive end bearing size

# General Information

## HOW TO READ A MODEL NUMBER:

Each Marathon Motors motor carries a model number that can be used to define some of the motor's physical and electrical characteristics.

Example (For Fractional): 1PC48C17D2000AP

This is a breakdown of the model on the nameplate:

<u>1</u>	<u>P</u>	<u>C</u>	<u>48</u>	<u>C</u>	<u>17</u>	<u>D</u>	<u>2000</u>	<u>A</u>	<u>P</u>
1	2	3	4	5	6	7	10	11	12

This is a breakdown of the model in the catalog:

<u>48</u>	<u>C</u>	<u>17</u>	<u>D</u>	<u>2000</u>
4	5	6	7	10

Example (For Integral): 2QA215TBDR A 7076 AL L

This is a breakdown of the model on the nameplate:

<u>2</u>	<u>Q</u>	<u>A</u>	<u>215T</u>	<u>B</u>	<u>D</u>	<u>R</u>	<u>A</u>	<u>7076</u>	<u>AL</u>	<u>L</u>
1	2	3	4	5	7	8	9	10	11	12

This is a breakdown of the model in the catalog:

<u>215T</u>	<u>B</u>	<u>D</u>	<u>R</u>	<u>A</u>	<u>7076</u>
4	5	7	8	9	10

- Date Code** - Year of Manufacture (Not shown in catalog listings.)
- Thermal Protection** (Not shown in catalog listings.)

	UL Recognized Motor Protector Combination	UL Recognized Motor Construction
Automatic Reset	Automatic Reset	Automatic Reset
Q	Yes	Yes
S	No	No
U	No	Yes
W	#	Yes
Manual Reset	Manual Reset	Manual Reset
P	Yes	Yes
Z	No	Yes
X	No	No
None	None	None
V	No	Yes

# Motor protector combination is U.L. recognized only if motor is used in direct drive fan duty application, and is under locked rotor condition, or is running under no-load condition.

- Date Code** - Month of Manufacturer (Not shown in catalog listings.)
- NEMA Frame Size** - (Integral motors - T and U designate standard shaft, TS and US designate short shaft)

## 5. Electrical Type

Single Phase:

- A = Permanent split capacitor
- B = Capacitor start, capacitor run
- C = Capacitor start, induction run
- N = Split phase start, capacitor run
- S = Split phase

Three Phase:

- T = Three phase
- H = Inverter Duty/IEEE841 Inverter Duty
- V = Medium Voltage

DC Power:

- E = Permanent Magnet DC

## 6. RPM or Speed at 60 Hz (Fractional Only)

- 34 = 2-Pole, 3600 rpm
- 17 = 4-Pole, 1800 rpm
- 11 = 6-Pole, 1200 rpm
- 8 = 8-Pole, 900 rpm

## 7. Enclosure

- D = Dripproof
- E = Explosion proof, non-ventilated
- F = Totally enclosed, fan cooled
- G = Explosion proof, fan cooled
- O = Open
- P = Partial
- S = Semi-enclosed
- T = Totally enclosed, non-ventilated
- V = Washdown, non-ventilated
- W = Washdown, fan cooled

## 8. Frame Construction

### Integral

- L = Aluminum (Full Frame)
- Y = Aluminum (Full Frame)
- Z = Aluminum (High Mount Down Frame)
- H = Aluminum - Sourced
- R = Rolled Steel (Full Frame)
- W = Rolled Steel (Full Frame)
- X = Rolled Steel (High Mount Down Frame)
- B = Rolled Steel - Sourced
- S = Cast Iron (Full Frame)
- N = Cast Iron (Full Frame)
- P = Cast Iron (High Mount Down Frame)
- C = Cast Iron - Sourced
- D = Stainless Steel

### Fractional (where applicable)

- B = Rolled Steel - Sourced
- D = Stainless Steel - Sourced
- U = Frameless - Sourced

## 9. Style Letter (A, B, C, etc. indicate redesign)

## 10. Sequence Number

## 11. Minor Modification Letter(s)

Fractional - 1 letter; Integral - 2 letters

## 12. Manufacturing Code - A code for the factory where the motor was manufactured.



# General Information

## HOW TO READ A MODEL NUMBER: Continued

Example ("harmonized" motor design):

A	B	C	D	E	F	G	H	I
5	KH	3	6	K	G	142	-	X

### A. Rotating Device

### B. Type of Winding

- KH - Split Phase
- KC - Capacitor Start, Induction Run
- K - Polyphase
- KCP - Permanent Split Capacitor
- KCR - Capacitor Start, Capacitor Run

### C. Lamination Size

- 3 - 48 frame, 4 - 56 frame

### D. Length of Frame

	48 frame	56 frame
2	5.17	5.73
3	5.42	6.63
4	None	None
5	5.80	7.11
6	6.23	None
7	6.63	7.63
8	7.23	8.44
9	Spec.	Spec.

### E. Stack Length

A - 5/8"	F - 1-1/4"	L - 1-7/8"	S - 3.0"
B - 3/4"	G - 1-3/8"	M - 2.0"	T - 3-1/4"
C - 7/8"	H - 1-1/2"	N - 2-1/4"	U - 3-1/2"
D - 1.0"	J - 1-5/8"	P - 2-1/2"	W - 4.0"
E - 1-1/8"	K - 1-3/4"	R - 2-3/4"	Q - Spec.

### F. Endshield Construction

- G & N - Aluminum
- K - Steel
- C - Cap/Can

### G. Sequence Number

### H. Current Revision (blank if original)

### I. Type of Overload

- X - UL Auto running & locked rotor
- Y - UL Manual running & locked rotor
- S - UL Auto locked rotor
- T - Non-UL Auto running & locked rotor
- U - Non-UL Manual running & locked rotor
- V - Thermostat
- W - UL Motor Parts

## ORDERING INFORMATION

When ordering, please include the model number, catalog number, description of the motor, quantity, shipping and billing instructions. For pricing of non-stock motors, or if you need assistance in selecting the proper motor, please contact your nearest Marathon Motors sales representative or local Marathon Motors Distributor. **All prices and data are subject to change without notice.**

## CANCELLATIONS AND RETURNS

### Stock Product

Stock product can be returned for credit as defined herein. Equipment must be in original packaging, unused in "as shipped" condition and is **limited to products currently maintained in stock inventory**. The quantity returned cannot exceed Marathon Motors's normal stock quantity level. All motors returned must have date codes no older than 18 months from date of manufacture. The minimum restocking charge is 15% of the original net purchase price. Modified and build to order motors cannot be returned for credit. Return freight charges are the responsibility of the customer returning the motor for credit. **No returns will be accepted without prior authorization.**

### Non-stock Product Cancellation policy:

Cancellation charges for non-stock orders received and entered will be determined based on the percentage of completion in the engineering and manufacturing process, accounting for all costs plus a reasonable profit. Marathon Motors's determination of the cancellation charges shall be conclusive.

## DISCOUNTS AND MULTIPLIERS

Except as noted, all prices in this catalog are list prices. 200 and 575 volt 3 phase ratings utilize the same list price as 230/460 volt. NEMA short shaft (TS) utilize the same list price as standard shaft (T). Contact Marathon Motors for special bearing systems, including all requirements for sleeve or roller bearing. For your discount and multiplier, contact your local Marathon Motors sales representative or local Marathon Motors Distributor.

## MODIFICATION/ACCESSORIES

See the Modification/Accessories Sections for more information on modifications to create special motor variations.

## General Information

### STOCK, NON-STOCK AND BUILD UP MODELS

Standard motors listed in this catalog, as indicated with a check mark (¼) next to the catalog number, are normally in stock. There is no minimum order quantity or minimum billing charge associated with stock motors, unless stated otherwise in your quotation or agreement with Marathon Motors.

Production of non-stock catalog models and all build-up models is subject to minimum order quantities or setup charges listed below.

48-140 Frame = 25 piece minimum  
 180-210 Frames = 5 piece minimum or \$200 set-up/model  
 250-320 Frames = 5 piece minimum or \$300 set-up/model

Build-up motors must be thoroughly described at time of order, and/or associated with a formal quotation issued by Marathon Motors. **Inclusion of product features for similar motors documented in this catalog should not be assumed.**

### SERVICE

For service on any Marathon Motors motor, contact your nearest Marathon Motors Authorized Service Station. For a complete listing of all domestic and foreign service stations, refer to [www.marathonelectric.com](http://www.marathonelectric.com).

### OPERATION AND MAINTENANCE

For information on operation and maintenance, please consult the manual or card shipped with your new motor. Additional copies of "Installation, Operation & Maintenance Instructions" (brochure SB181) are available upon request or through our website, [www.marathonelectric.com](http://www.marathonelectric.com).

### STORAGE PROCEDURES

In the event that long-term storage of motors is required, Marathon Motors recommends the following precautions and procedures. This information is also contained in "Installation, Operation and Maintenance Instructions" (SB181).

#### A. Keep motors clean

1. Store indoors
2. Keep covered to eliminate airborne dust and dirt.
3. Cover openings for ventilation, conduit connections, etc., to prevent entry of rodents, snakes, birds and insects.

#### B. Keep motors dry

1. Store in a dry area indoors
2. Temperature swings should be minimal to prevent condensation.
3. Space heaters are recommended to prevent condensation.
4. Treat unpainted flanges, shafts and fittings with a rust inhibitor.
5. Check insulation resistance before putting motor into service.

#### C. Keep bearings lubricated

1. Once per month, rotate shaft several turns to distribute grease in bearings.
2. If unit has been stored more than one year, add grease before start-up (refer to lubrication procedure).

### DIMENSION DRAWINGS

See Marathon Motors's website: [www.marathonelectric.com](http://www.marathonelectric.com) or request certified drawings through your Marathon Motors Sales Engineer, Representative or local Marathon Motors Distributor.

# General Information

## WARRANTY

Marathon Motors warrants Fractional and Integral motors to be free from defects in materials and workmanship and to conform to Marathon's written specifications.

Motor Type	Warranty Period from Date of Installation*	Warranty Period from Date of Manufacture*
Standard Warranty for any product not shown below	12	18
Medium Voltage	12	18
EPAct compliant (aluminum, steel & cast iron frame)	24	30
Blue Chip® Severe Duty Explosion Proof	24	30
Blue Max®, Black Max®, & microMax™ Inverter Duty	36	42
All NEMA Premium® incl. ODP, Blue Chip®, Severe Duty, Explosion Proof, etc.	36	42
U-Frame Automotive Duty	60	66
Blue Chip® IEEE-841	60	66

\* Warranty period shown is in months, and is valid for whichever period expires first.

Note: Brake discs are considered a normal maintenance item and are not covered under warranty.

For more information, on Marathon Motors's warranty policy, refer to the "Terms and Conditions of Sale" (MPN411) in the back of this catalog.

## SUBMITTAL DATA

Mechanical and electrical submittal data is available on many stock catalog motors through our website [www.marathonelectric.com](http://www.marathonelectric.com) by following the three steps listed on the next page. All other submittal data is available upon request when accompanied by a purchase order for the specified motor, **subject to the following additional charges**

## SUBMITTAL CHARGE SCHEDULE

TYPE	ELEMENTS	NET/EA
BASIC (.PDF format)	Nameplate data Motor characteristics Performance data Outline drawing External connection diagram	No-Charge
	Add for .dxf or .dwg format	\$25
BASIC-PLUS (.pdf format)	All "BASIC" elements, tailored to specific order.	\$75
	"Cut sheets" of installed accessories Add for .dxf or .dwg format	\$25
ADDITIONAL ITEMS (.pdf formats)	Speed/Torque curve	\$50
	Torque capability curve	\$50
	Commercial (end of line) test results (not available for West Plains motors)*	\$50
	Certificate of conformance	\$100
	Thermal damage curve (48-326T frame)	\$500 + cost of additional motor
	Thermal damage curve (364T-6805 frame)	\$1500 +cost of additional motor
* Does not imply retesting		

# General Information

1. From our homepage, click on the Motors link. From the Motors page, enter in the Marathon Catalog number or Model number.

Then click on Model number in results window.

(Note: If you already have a Marathon Motors motor and are looking for the performance data, make sure the model number off the nameplate is what you use for your search. Ex. 056H17T5301).



2. The Motor Model Details page will appear. You will be able to print dimensional drawings and connection diagrams in PDF format for the motors. Under the Technical Data section, click on the link, Certification Data Sheet.

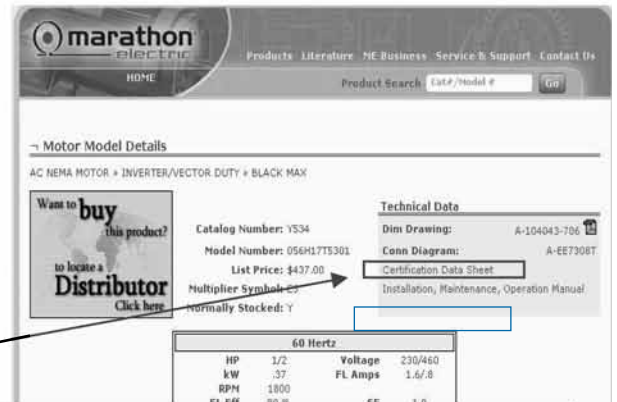

3. Your results will look similar to the example shown to the right for Marathon's 1/2 HP, Black Max® motor, model # 056H17T5301. It's that easy!

**marathon electric**

CERTIFICATION DATA SHEET

MODEL NUMBER: 056H17T5301  
SERIAL NUMBER: A-104043-706

TECHNICAL MOTOR PERFORMANCE DATA

HP	VF	SYNCH. RPM	FL. RPM	FL. TORQUE	FL. CURR.	EFFICIENCY	POWER FACTOR	STARTING TORQUE	STARTING CURR.	STARTING INERTIA
1/2	230V	1800	1725	0.37	1.6	80.3%	0.85	1.6	1.6	0.001

EXTRAORDINARY MOTOR PERFORMANCE DATA

HP	VF	SYNCH. RPM	FL. RPM	FL. TORQUE	FL. CURR.	EFFICIENCY	POWER FACTOR	STARTING TORQUE	STARTING CURR.	STARTING INERTIA
1/2	230V	1800	1725	0.37	1.6	80.3%	0.85	1.6	1.6	0.001

ADDITIONAL PERFORMANCE DATA

TEMPERATURE	INSULATION CLASS	TEMPERATURE RISE	TEMPERATURE RISE	TEMPERATURE RISE	TEMPERATURE RISE	TEMPERATURE RISE	TEMPERATURE RISE
40°C	B	100°C	100°C	100°C	100°C	100°C	100°C

GENERAL INFORMATION

DESCRIPTION	PROTECTION	WINDING	INSULATION	TEMPERATURE	TEMPERATURE	TEMPERATURE	TEMPERATURE
STATISTICAL	IP54	IP54	IP54	IP54	IP54	IP54	IP54

# Application Information

## AGENCY LISTINGS

### UL and CSA

Marathon Motors's Fire Pump and Explosion Proof motors are UL Listed. Other motor types are UL Recognized, including models with inherent overheating protection as noted (i.e. thermally protected models). Marathon motors are also CSA Certified for both explosion proof and non-explosion proof enclosures.

### AC Motors

Non-Explosion Proof	UL File No.	CSA File No.
NEMA 48-449 Frame	E49747	LR2025
All 5K type models numbers	E46035	MC236833
NEMA 500 and 5000 Frame	—	LR2025*
IEC 63-90 Frame	E49747	LR2025
IEC 100-280 Frame	E49747	LR2025*
Thermally Protected motors	E6312	LR2025
Thermally Protected 5K motors	E14133	MC236833
Insulation Systems	E37900	LR2025
* Does not include coverage for use with VFD		
* Domestic product only		
Explosion Proof	UL File No.	CSA File No.
NEMA 56-326 Frame	E12044	LR47504
NEMA 364-449 Frame	E12044	LR21839
Fire Pump Motors	UL File No.	CSA File No.
NEMA 143-510	EX5190	LR2025
Class I, Division 2/Zone 2	UL File No.	CSA File No.
NEMA 48-449, 5000 Frame	—	LR21839
European ATEX Zone 2	Intertek Certificate No.	
NEMA 143-449, IEC 112-280	ITS06ATEX45370	

### PMDC Motors

Non-Explosion Proof	UL File No.	CSA File No.
NEMA 56-145	E49747	E49747

### CE (Conformity Europeenne)

CE marking on the nameplates of Marathon Motors motors is available upon request for most motors rated 600V or less. We do not apply the CE Marking to explosion proof motors. The European "Low Voltage" Directive applies to electric motors. Contact a factory representative for details. Non-explosion proof microMAX™, BlackMax® and BlueMax® (TENV and TEFC) standard (catalog) models have the CE Mark on the nameplate.

### ATEX Directive (ATmospheres EXplosibles)

Mandatory by law, the European Union (EU) Directive 94/9/EC requires that electric motors for use in explosive atmospheres carry the CE mark, notified body identifier, Ex symbol, equipment group and category, plus the date code. See "European Installations" for additional details, located on the next page.

### NEMA (National Electrical Manufacturers Association)

Marathon Motors motors are manufactured in accordance with all applicable areas of NEMA standards in MG1-2006. When applied in accordance with the "Guidelines for Application of Three Phase Motors on Variable Frequency Drives", **Marathon Motors motors are in full compliance with NEMA MG1-2006, Part 31, Section 4.4.2**, as pertaining to voltage spikes. 460 volt motors must withstand voltage spikes of up to 1426

volts; 575 volt motors must withstand spikes up to 1788 volts. See "Insulation Systems" for additional detail on this subject.

### Commitment to RoHS and WEEE European Directives

European Directive 2002/95/EC "Restriction of Use of Certain Hazardous Substances" (RoHS) and Directive 2002/96/EC "Directives on Waste Electrical and Electronic Equipment" (WEEE) were enacted to control the amount of certain hazardous substances contained in products shipped into the E.U. Restricted substances include lead, mercury, cadmium, hexavalent chromium, polybrominated biphenyls and polybrominated dipheynl ethers.

The scope of products covered, affecting motors, is:

- Large household appliances
- Small household appliances
- IT and telecommunications equipment
- Consumer equipment
- Electrical and electronic tools (except large scale stationary and industrial tools)
- Toys, leisure and sports equipment
- Automatic dispensers

The Directives do not currently apply to medical devices, monitoring and control instruments, spare parts for the repair or reuse of electrical and electronic equipment placed on the market before July 1, 2006, and most military and state security equipment.

Regal Beloit Corporation worked closely with suppliers to assure that product falling within the scope of these Directives meets the specified levels of these substances. The Directives took affect July 1st, 2006 however many products were converted in May and June. The products converted are motors in NEMA frame size 145 and below, both AC and DC motors with the following exceptions:

- Sleeve bearing motors
- Brake motors in 56-145 frame will have to be ordered specifically as RoHS compliant.
- Some motors with specialty electro-mechanical components.

### BEARINGS

FRAME SIZE	STANDARD TYPE	COMMENTS
48	Shield Ball	
56 - 184T	Sealed Ball	
182 - 444T	Double Shield Ball	
284 - 449TS	Single Shield Ball	
445T - 6805	Double Shield Ball	Direct - coupled loads
445T - 6805	Roller (DE)/Ball	Belted loads

\* **Beltting data must be provided on all belted applications**

Standard horizontal motors can be mounted in a vertical shaft down orientation (except brakemotors). Contact a factory representative for shaft up mounting arrangements.

Motors for use in vertical shaft up or shaft down configurations must be reviewed by Engineering before ordering.

Continued on next page.

# Application Information

Marathon Motors motors employ the use of Mobil POLYREX<sup>®</sup> EM grease, a specially formulated bearing grease designed for electric motors. POLYREX<sup>®</sup> EM provides superior lubricity, durability and resists corrosion, rust and washout. POLYREX<sup>®</sup> EM is a registered trademark of Mobil Corporation.

Maximum safe mechanical speed capability is a function of bearing size, type and grease selection, as well as rotor balance specifications. Consult the "Maximum Safe Mechanical Speed Limits" chart in the "Overspeed Capability" section.

Note that these values do not imply maximum constant horsepower RPM.

## EFFICIENCY

The efficiency of a motor is the ratio of its useful power output to its total power input and is usually expressed in a percentage. Marathon Motors offers standard, high efficient EAct, and NEMA Premium<sup>®</sup> efficient (XRI) ratings. Standard efficiency motors may only be used on applications that are exempt from legislated efficiencies. The high efficient motor line is in compliance with the Energy Policy Act of 1992 (EAct) and/or Canadian efficiencies as set by NRCAN. The Energy Independence and Security Act of 2007 (EISA07) will become law on December 19, 2010, requiring current EAct-compliant motors to meet NEMA Premium<sup>®</sup> efficiencies, and most EAct-exempt motors to meet EAct levels. XRI Premium efficient motors in this catalog meet NEMA Premium<sup>®</sup> unless otherwise noted.

The XRI<sup>®</sup> line is a premium efficiency line, which exceeds mandated efficiencies of EAct and /or NRCAN. Unless otherwise noted, XRI<sup>®</sup> premium efficient motors in this catalog meet NEMA Premium<sup>®</sup> the newly promoted efficiency levels by NEMA and the Consortium for Energy Efficiency (CEE).

## ELECTRICAL TYPE/STARTING METHOD

Motors in this catalog are capacitor start, split phase, permanent split capacitor, or three phase. Capacitor Start motors have high starting torque, high breakdown torque, and relatively low starting current. Split phase motors have medium starting torque and medium starting current. Permanent split capacitor motors have low starting torque and low starting current. Three phase motors have high starting, extra breakdown torque, and typically very low starting current. Single phase motors cannot be applied on variable frequency drives with three phase output.

## ENCLOSURE AND METHOD OF COOLING

Marathon Motors motors are available in various enclosures; Dripproof (DP), Dripproof Force Ventilated (DPFV), Totally Enclosed Fan Cooled (TEFC), Totally Enclosed Non-Ventilated (TENV), Totally Enclosed (TEAO) and Totally Enclosed Blower Cooled (TEBC). Application conditions will determine the type of motor enclosure required.

Dripproof motors have open enclosures and are suitable for indoor use and in relatively clean atmospheres. Dripproof motors have ventilating openings constructed so that drops of liquid or solid particles falling on the machine at an angle of not greater than 15 degrees from the vertical cannot enter the machine.

Totally enclosed motors are suitable for use in humid environments or dusty, contaminated atmospheres. Totally enclosed non-ventilated motors are NOT cooled by external means. Totally enclosed fan cooled motors are cooled by external means that are part of the motor but not in the internal workings of the motor. Totally enclosed air over motors are sufficiently cooled by external means, provided by the customer.

## HAZARDOUS DUTY™

Hazardous Duty™ motors are totally enclosed (fan cooled or non-ventilated) motors designed for applications in hazardous atmospheres containing explosive gases and/or combustible dusts.

## North American installations

North American standards for electric motors generally fall into one of two divisions. Division 1 Explosion Proof motors are UL Listed in accordance with NFPA Class I (Flammable Gases) or Class II (Combustible Dusts) and Groups (gases or dusts), depending upon the atmosphere. Division 2 motors are CSA Certified and are marked similarly to Division 1 equipment. Inverter Duty motors through 449T frames are CSA Certified for use in Division 2 locations.

## European installations

Motors for hazardous locations in Europe must meet a different set of standards and require different markings than those of North America. CENELEC sets the standards for equipment in hazardous locations for Europe. Motors for use in explosive atmospheres in Europe are often referred to as flameproof (Zone 1) or non-sparking (Zone 2) motors. These motors must comply with the ATEX Directive. The ATEX Directive covers all electrical equipment used in explosive atmospheres. To ensure compliance with the Directive, equipment must meet the essential ATEX requirements and carry the CE mark on the nameplate. Other information required on the nameplate includes the Ex symbol, group & category, Ex protection method, gas group, and temperature code, example (Ex) II 3 G Ex nA IIC T3).

**The tables on the next page describe Marathon Motors's capabilities by Area Classification and by Temperature Code.**

## IEC DEGREES OF PROTECTION vs. MARATHON MOTOR'S STANDARD CONSTRUCTION

The enclosure terminology for an IEC motor is a combination of the IP (Ingress Protection) and IC (Inherent Cooling) codes. Each number in the IP code stands for a different degree of protection.

- IP12 - Dripproof
- IP22 - Dripproof with screens, or die cast aluminum bracket
- IP43 - Totally Enclosed
- IP54 - Totally Enclosed Severe Duty
- IP55 - Totally Enclosed Severe Duty with V-Ring Shaft seals, and/or "Smart Ring" rotating shaft seal and Neoprene gaskets
- IP56 - Totally Enclosed Severe Duty with rotating Shaft seals (eg. Inpro/Seal<sup>®</sup> VBX bearing isolator) and Neoprene gaskets

# Application Information

## Marathon Motors Hazardous Duty Motor Area Classification Chart

Class I Area Classification (Flammable Gases, Vapors or Mists)				Class II Area Classification (Combustible Dusts)			
North America		Europe - ATEX (Category G - Gases)		North America		Europe - ATEX (Category D - Dusts)	
Division 1 Explosion Proof	Division 2 TEFC & TENV	Zone 1 Flameproof	Zone 2 Non-Sparking	Division 1 Explosion Proof	Division 2	Zone 21 Flameproof	Zone 22 Non-Sparking
Group A <sup>①</sup>	Group A	Contact Marathon Motors for ATEX Zone 1 capabilities	Group IIC, Category G	-	-	-	-
Group B <sup>②</sup>	Group B		Group IIC, Category G	-	-	-	-
Group C	Group C		Group IIB, Category G	-	-	-	-
Group D	Group D		Group IIA, Category G	-	-	-	-
-	-	-	-	Group E	-	Category D	Category D
-	-	-	-	Group F	Group F <sup>①</sup>	Category D	Category D
-	-	-	-	Group G	Group G <sup>①</sup>	Category D	Category D

- Group is not applicable to that Division or Zone, or is not defined.

① Group is not available from Marathon Motors.

② Contact factory representative for availability.

APPLICATION INFORMATION

## Marathon Motors Hazardous Duty Motor Temperature Code Chart

	TEMPERATURE CODES		Division 1 Explosion Proof/Zone 1 Flameproof		Division 2/Zone 2 Non-Sparking
			Class I Area Classification (Flammable Gases, Vapors or Mists)	Class II Area Classification* (Combustible Dusts)	Class I Area Classification (Flammable Gases, Vapors or Mists)
Temp.	UL/CSA	ATEX	Division 1/Zone 1	Division 1/Zone 21	Division 2/Zone 2
280°C	T2A	T2(280)	Explosion Proof - Class I, Group D (Group C as noted)		
260°C	T2B	T2(260)			XRI <sup>®</sup> Severe Duty & IEEE-841 @ 1.15 S.F., Class I, Groups A,B,C,D (Sine wave power)
215°C	T2D	T2(215)			Available through Marathon's Mod Central on Totally Enclosed EPAct, XRI <sup>®</sup> , XRI <sup>®</sup> Severe Duty or IEEE-841 @ 1.0 S.F. on PWM VFD, Class I, Groups A, B, C, D
200°C	T3	T3			Available through Marathon's Mod Central on Totally Enclosed EPAct, XRI <sup>®</sup> , XRI <sup>®</sup> Severe Duty or IEEE-841 @ 1.0 S.F., Sine wave power Class I, Groups A, B, C, D
165°C	T3B	T3(165)	Explosion Proof - Class I, Group D (Group C as noted), Sine wave or PWM power	Explosion Proof - Class II, Groups F & G, Sine wave or PWM power	
160°C	T3C	T3(160)	Available through Marathon's Mod Central on Explosion Proof - Class I, Group C & D @ 1.0 S.F. - Contact Factory	Available through Marathon's Mod Central on Explosion Proof - Class II, Group F & G @ 1.0 S.F. - Contact Factory	
135°C	T4	T4	ATEX compliant motors	ATEX compliant motors	

Division I & II ambient range is -25°C to +40°C

ATEX ambient range is -20°C to +40°C

Consult Marathon Motors for higher ambients

# Application Information

## INSULATION SYSTEMS

**Class B** – General Purpose motors that employ Class B insulation systems have a total temperature rating of 130°C and maximum allowable temperature rise of 80°C at 1.0 S.F.

**Class F** – Motors with a Class F system have a total temperature rating of 155°C, with a maximum temperature rise of 105°C at 1.0 S.F. Many Marathon Motors designs utilize a Class F system but limit temperature rise to no higher than “B” rise, providing thermal “headroom” for longer insulation life.

**Class H** – Class H insulated motors have a total temperature rating of 180°C and maximum allowable temperature rise of 125°C. All Marathon Motors motors that employ a Class H system are designed to operate between “B” and “F” rise, giving the user a generous thermal cushion.

“CR200” – Corona Resistant, 200° rated magnet wire is utilized in numerous general purpose and inverter duty motor designs to extend insulation life under the rigors of steep fronted voltage spikes, common with today’s IGBT inverters. Refer to page 17 for product lines that employ the use of CR200 magnet wire.

Motors with the CR200 insulation system can be operated at up to 475 feet from the drive on 460 volt systems, at 3 KHz carrier frequency. For other voltages and/or carrier frequency combinations, contact a factory representative.

**MAX GUARD®** – All Black Max®, Blue Max®, Blue Chip®, XRI® Severe Duty and XRI®-841 (IEEE841) motors feature the MAX GUARD® insulation system, either in conjunction with Class F or Class H materials. Combining corona-resistant magnet wire (CR200) with our patented “low stress” winding configuration and uncompromising quality standards, MAX GUARD® delivers long, dependable motor life under the adverse thermal and dielectric stresses imposed by IGBT-based variable frequency drives. **MAX GUARD® surpasses the requirements of NEMA MG1-2006, Part 31, Section 4.4.2.**

**460 Volt (or lower) motors equipped with MAX GUARD® can be operated at any distance from the drive and at any carrier frequency. 575 Volt motors can be operated at up to 650 feet cable length at 3 KHz.**

## MOUNTING

Most Marathon Motors motors are designed for horizontal mounting (shaft parallel with ground), unless designed otherwise, such as Vertical P Base motors. As a general rule, a horizontal motor can also be mounted in a vertical shaft down orientation. Horizontal motors should never be mounted in a vertical shaft up orientation without consulting your application engineer, as this practice can cause damage to the motor, which is not covered under warranty. Brake motors should not be mounted vertically (up or down), unless the brake has been specifically designed for such.

## NEMA SERVICE FACTOR RATINGS

The table below lists the NEMA service factors for single phase, dripproof motors. Totally enclosed and explosion proof motors have 1.0 service factor except where noted.

### Single Phase

#### NEMA SERVICE FACTOR @ RPM LISTED

HP	3600	1800	1200	900
1/12	1.4	1.4	1.4	1.4
1/8	1.4	1.4	1.4	1.4
1/6	1.35	1.35	1.35	1.35
1/4	1.35	1.35	1.35	1.35
1/3	1.35	1.35	1.35	1.35
1/2	1.25	1.25	1.25	1.15
3/4	1.25	1.25	1.15	1.15
1	1.25	1.15	1.15	1.15
1.5 & Up	1.15	1.15	1.15	1.15

## OVERLOAD PROTECTION

There are four choices in protection: manual (inherent type), automatic (inherent type), thermostats, and none. A manual overload must be physically reset to restart the motor. An automatic thermal overload will stop the motor when it is overloaded or overheated and restart it after the motor has cooled down. None means the motor has no protection. Thermostats are embedded in the winding and connected to the motor starter control circuit. Marathon Motors’s standards are normally closed thermostats, one per phase.



**A motor with an automatic reset protector must not be used where automatic restarting (after motor cool-down) would endanger personnel or equipment. Such applications should use a manual reset protector.**

## PHASE/POWER SUPPLY

Is the power supply three phase or single phase? Most home and farm applications require single phase motors, while most factories, large commercial and industrial users require three phase motors. Single phase motors can be used on three phase systems. Three phase motors, however, cannot be operated from single phase systems. Motor damage will result.

## ROTATION

Most motors in this catalog are reversible by electrical reconnection or by physical orientation. Marathon Motors’s standard rotation from the factory for single phase motors is counterclockwise, when viewing the opposite shaft end of the motor.

## SPEED/RPM

3600, 1800, and 1200 are the most common 60 HZ synchronous speeds with full load speed equivalents of 3450, 1725, and 1150.



# Application Information

## TERMINOLOGY

**Ambient Temperature** – Temperature of the medium, such as air, water or earth, into which the heat of the equipment is dissipated.

**Across The Line Start** - A method of motor starting that applies full line voltage to the motor. The motor is connected directly to the power source.

**Base Speed** – Nameplate rating where the motor will develop rated HP at rated load and voltage. With AC systems, it is commonly the point where 60 Hz is applied to the induction motor.

**Breakaway Torque** – The torque required to start a machine from standstill.

**Breakdown Torque (BDT)** – The maximum torque that an AC motor will develop with rated voltage applied at rated frequency while rotating.

**Cogging** – A condition in which a motor does not rotate smoothly but “steps” or “jerks” from one position to another during shaft revolution. Cogging is most pronounced at low motor speeds and can cause objectionable vibrations in the driven machine.

**Continuous Duty** – The continuous rating is the maximum constant load that can be carried continuously without exceeding established temperature rise limitations under prescribed conditions of load and within the limitations of established standards.

**Definite Purpose Motor** – Any motor design, listed and offered in standard ratings with standard operating characteristics and mechanical construction, for use under service conditions other than usual or for use on a particular type of application (NEMA).

**Duty Cycle** – The relationship between the operating and resting times or repeatable operation at different loads and/or speeds.

**Efficiency** – Ratio of power output to power input indicated as a percentage. In motors, it is the effectiveness with which a motor converts electrical power into mechanical power.

**Frequency** – Number of cycles per second of alternating current 60HZ used primarily in the United States, 50HZ normally used overseas.

**Full Load Torque (FLT)** – The torque necessary to produce rated horsepower at full load speed.

**General Purpose Motor** – This motor has a continuous duty rating and NEMA A or B design, listed and offered in standard ratings with standard operating characteristics and mechanical construction for use under usual service conditions without restriction to a particular application or type of application (NEMA).

**Inertia** – A measure of a body’s resistance to changes in velocity, whether the body is at rest or moving at a constant velocity. The velocity can be either linear or rotational. The moment of inertia ( $WK^2$ ) is the product of the weight ( $W$ ) of an object and the square of the radius of gyration ( $K^2$ ). The radius of gyration is a measure of how the mass of the object is distributed about the axis of rotation.  $WK^2$  is usually expressed in units of lb-ft<sup>2</sup>.

**Inrush Current** – The initial surge of current into the windings. Inrush current can be up to ten times higher than the continuously needed current because there is low initial resistance.

**Intermittent Duty** – A motor that never reaches equilibrium temperature, but is permitted to cool down (to ambient temperature) between operations. For example, a crane, hoist or machine tool motor is often rated for 15, 30 or 60 minute duty.

**Load Sharing** – An application condition in which two or more similar-sized AC Induction motors are mechanically connected to each other and powered from the same inverter. Optimum load sharing is achieved with higher slip (NEMA Design B or C) motors.

**Locked Rotor Current (LRA)** – Steady state current taken from the line with the rotor at standstill, at rated voltage and frequency. This is the current when starting the motor and load across the line.

**Locked Rotor Torque (LRT)** – The minimum torque that a motor will develop at rest for all angular positions of the rotor, with rated voltage applied at rated frequency.

**No Load (Conditions)** – The state of a machine rotating at normal speed under rated conditions, but when no output is required from it.

**Part Winding Start (PWS)** – A method of reduced voltage starting that applies power to only one set of windings, then to the other set as the motor comes up to speed.

**Power Factor** – Power factor is the ratio of real power (kW) to total kVA, or the ratio of actual power (W) to apparent power (volt-amperes).

**Reactance** – The opposition to the flow of current made by an induction coil or a capacitor. Performance data expresses stator reactance as X1 and rotor reactance as X2.

**Resistance** – The opposition to voltage or current in an electrical circuit. Performance data expresses stator resistance as R1 and rotor resistance as R2.

**Rotor** – The rotating member of a machine with a shaft.

**Service Factor (SF)** – When used on a motor nameplate, a number which indicates how much above the nameplate rating a motor can be loaded intermittently without causing serious degradation (i.e. a motor with 1.15 SF can produce 15% greater torque than one with 1.0 SF, within temperature constraints).

**Squirrel Cage Induction Motor** – When used on a motor nameplate, a number which indicates how much above the nameplate rating a motor can be loaded without causing serious degradation (i.e. a motor with 1.15 SF can produce 15% greater torque than one with 1.0 SF, within temperature constraints).

# Application Information

## TERMINOLOGY

**Shock Load** – The load seen by a clutch, brake or motor in a system that transmits high peak loads. This type of load is present in crushers, separators, grinders, conveyors, winches and cranes.

**Slip** – The difference between the speed of the rotating magnetic field (synchronous speed) and mechanical rotational speed (rotor speed) of AC induction motors. Usually expressed as a percentage of synchronous speed.

**Special Purpose Motor** – A motor with special operating characteristics, special mechanical construction, or both, designed for a particular application and not falling within the definition of a general purpose or definite purpose motor (NEMA).

**Speed Range** – The minimum and maximum speeds at which a motor must operate under constant or variable torque load conditions. A 50:1 speed range for a motor with top speed of 1800 RPM means the motor must operate as low as 36 RPM and still operate within specifications.

**Starting Torque** – The torque exerted by the motor during the starting period.

**Stator** – The stationary portion of the magnetic circuit and the associated windings and leads of a rotating machine.

**Synchronous Speed** – The speed of an AC induction motor's rotating magnetic field. It is determined by the frequency applied to the stator and the number of magnetic poles present in each phase of the stator windings. Mathematically, it is expressed as Sync Speed (RPM) =  $120 \times \text{Applied Frequency (Hz)} / \text{Number of Poles per phase}$ .

**Torque** – A turning force applied to a shaft, tending to cause rotation. Torque is normally measured in "pound-feet" and is equal to the force applied times the radius through which it acts.

**Torque-to-Inertia Ratio** – The rated motor torque divided by its rotor inertia. Helps determine a motor's ability to accelerate loads and/or respond to commands from a drive to change speed or direction.

**Voltage Drop** – The reduction in voltage level from the source to the load caused by conductor resistance.

**Wye Start Delta Run (YD)** – A method of reduced voltage starting that first connects a motor in a wye to reduce voltage, then reconnects the motor in a delta to provide full line voltage.

## FORMULAS & CONVERSION FACTORS

$$\text{Horsepower (HP)} = \text{Torque (lb-ft)} \times \text{RPM} / 5252$$

$$\text{Horsepower (HP)} = \text{Torque (lb-in)} \times \text{RPM} / 63025$$

$$\text{Torque (lb-ft)} = \text{HP} \times 5252 / \text{RPM}$$

$$\text{Torque (lb-in)} = \text{HP} \times 63025 / \text{RPM}$$

$$\text{Efficiency} = \text{Power Out} / \text{Power In}$$

$$\text{Synchronous RPM} = 120 \times \text{Frequency} / \# \text{ Poles}$$

$$\text{Ohms} = \text{Volts} / \text{Amperes} (R = E/I)$$

$$\text{Amperes} = \text{Volts} / \text{Ohms} (I = E/R)$$

$$\text{Volts} = \text{Amperes} \times \text{Ohms} (E = IR)$$

$$\text{Static Torque (T)} = F \times R \text{ (lb-ft)},$$

$$F = \text{Force (lb)},$$

$$R = \text{pulley or drum radius (ft)}$$

$$\text{Pound-feet (torque)} = .7376 \times \text{Newton-meters}$$

$$\text{Newton-meters (torque)} = 1.3558 \times \text{lb-ft}$$

$$\text{Power (HP)} = \text{Torque (lb-ft)} \times 2\pi \times \text{RPM} / 33000$$

$$\text{Temperature (Celsius)} = 5/9 \times (F^\circ - 32)$$

$$\text{Temperature (Fahrenheit)} = (9/5 \times C^\circ) + 32$$

$$1 \text{ Kilowatt (KW)} = 1.341 \text{ Horsepower}$$

$$1 \text{ Horsepower} = 746 \text{ watts (.746 KW)}$$

$$\text{Brake Torque} = (5252 \times P / N) \times \text{SF}, P = \text{HP}, N = \text{RPM}, \text{SF} = 1.4$$

Use 2.0 to 2.5 SF for cranes and hoists (consult crane manufacturer or end-user).

# Variable Speed Operation

Guidelines for Application of General Purpose, Three Phase, Single Speed Motors on Variable Frequency Drives Meets NEMA MG1-2006 Part 30 and Part 31 Section 4.4.2 Unless stated otherwise, motor nameplates do NOT include listed speed range.

ENCLOSURE	EFFICIENCY	VARIABLE TORQUE	CONSTANT TORQUE								
		ALL FRAMES	56	143-215		254-286		324-365		404-449	
NEMA Motors		ALL POLES	ALL POLES	2-Pole	4&6 Pole	2-Pole	4&6 Pole	2-Pole	4&6 Pole	2-Pole	4&6 Pole
ODP	Standard (EPAAct exempt)	10:1	2:1	2:1	2:1	Contact Engineering					
	EPAAct compliant	10:1	N/A	2:1	2:1	2:1	2:1	Contact Engineering			
	NEMA Premium	10:1	N/A	10:1	10:1	10:1	10:1	10:1	10:1	2:1	2:1
TEFC	Standard (EPAAct exempt)	10:1	2:1	2:1	2:1	Contact Engineering					
	EPAAct compliant	10:1	N/A	2:1	10:1	2:1	10:1	2:1	2:1	2:1	2:1
	NEMA Premium	10:1	N/A	2:1	20:1	2:1	20:1	2:1	20:1 (1)	2:1	20:1 (1)
TENV	EPAAct compliant	10:1	N/A	1000:1	1000:1	1000:1	1000:1	1000:1	1000:1	1000:1	1000:1
	NEMA Premium	10:1	1000:1	1000:1	1000:1	1000:1	1000:1	1000:1	1000:1	1000:1	1000:1
Washdown TEFC	Standard (EPAAct exempt)	10:1	10:1 (2)	10:1 (2)	10:1 (2)	N/A	N/A	N/A	N/A	N/A	N/A
	EPAAct compliant	10:1	10:1 (2)	10:1 (2)	10:1 (2)	N/A	N/A	N/A	N/A	N/A	N/A
	NEMA Premium	10:1	10:1 (2)	10:1 (2)	10:1 (2)	N/A	N/A	N/A	N/A	N/A	N/A
Washdown TENV	Standard (EPAAct exempt)	10:1	1000:1	1000:1	1000:1	N/A	N/A	N/A	N/A	N/A	N/A
	EPAAct compliant	10:1	1000:1	1000:1	1000:1	N/A	N/A	N/A	N/A	N/A	N/A
	NEMA Premium	10:1	1000:1	1000:1	1000:1	N/A	N/A	N/A	N/A	N/A	N/A
Explosion Proof	All efficiency levels	Explosion Proof motors must be properly nameplated with inverter duty information prior to use on VFD. See Marathon catalog pages for specific rating capabilities. Motors with automatic overload protectors cannot be used on VFDs.									
IEC Motors		ALL FRAMES	63-90	100-225	250-315						
All Enclosures	All efficiency levels	10:1	20:1	Up to 20:1	Up to 2:1						

Notes: (1) 324-449T, 4 & 6 Pole XRI motors are rated for 20:1 C.T. with fan modification; otherwise rated for 2:1 C.T. continuous duty, or 20:1 C.T. 60 minute duty at lowest RPM.  
 (2) Washdown TEFC motors are rated for 10:1 C.T. 60 minute duty or 2:1 C.T. continuous duty at lowest RPM.  
 Model numbers beginning with 5K are not suitable for use with Variable Frequency Drives.

## Application Notes

Bearing currents	Marathon Motors recommends that any motors used with Variable Frequency Drives be equipped with suitable means to protect the motor bearings from shaft currents caused by common mode voltages inherent with operation on a non-sinusoidal power supply. Marathon Motors offers several options for motors in non-classified (non-hazardous) locations, including ground brushes, insulated bearings and non-contact shaft grounding rings. For more information on ground brushes and bearing currents, see the VARIABLE SPEED OPERATION section. For installation cost and available options, see the MOD CENTRAL section.
Restricted use	DO NOT APPLY THE FOLLOWING MOTORS ON VARIABLE FREQUENCY DRIVES: Single Phase motors, Motors with inherent overload protection, Multi-Speed motors, Motors with 1.0 Service Factor on sine wave power. Fire Pump motors should not be used with variable frequency power supplies, due to the critical nature of these applications.
Hazardous Locations	Consult with Marathon Motors when applying motors and drives into Hazardous Locations, either Division/Zone 1 or Division/Zone 2 areas. UL and CSA policies prohibit the installation of bearing protection devices, such as shaft grounding brushes, rings or insulated bearings on motors in Hazardous Locations.

## Maximum Cable Lengths from the Motor to Drive

PRODUCT DESCRIPTION	3 kHz CARRIER FREQUENCY (PHASE TO PHASE)*		
	230 VOLT	460 VOLT	575 VOLT
56-326 NEMA, 100-225 IEC Frames	600 ft.	125 ft.	40 ft.
364-5013 NEMA, 250-315 IEC Frames	1000 ft.	225 ft.	60 ft.
Motors with CR <sup>200</sup> Corona Resistant Magnet Wire	1500 ft.	475 ft.	140 ft.
Motors with MAX GUARD <sup>®</sup> insulation system	Unlimited	Unlimited	650 ft.
Form-wound low voltage motors	Unlimited	Unlimited	650 ft.

\* Higher carrier frequencies require shorter cable length to obtain normal (50Khrs) insulation life.

## Standard Motor Insulation Systems

CR200 CORONA-RESISTANT MAGNET WIRE	Max Guard <sup>®</sup> *
microMAX <sup>®</sup> inverter duty	Black Max <sup>®</sup> Vector Duty - All Product
"4 - in - 1" Three Phase, C-Face with Removable Base	Blue Max <sup>®</sup> Vector Duty - All Products
Standard Three Phase stock Brakemotors	PowerWash <sup>™</sup> XT, SXT, and SXT-Plus Washdown Duty - Three Phase
Blue Chip <sup>®</sup> Severe Duty Explosion Proof,	Blue Chip <sup>®</sup> XRI Severe Duty
EPAAct Efficiency	Blue Chip <sup>®</sup> XRI-841 (IEEE841 compliant)
Max +	Automotive Duty "T" Frame
	Blue Chip <sup>®</sup> Explosion Proof, XRI <sup>®</sup> Premium Efficiency
	Globetrotter <sup>®</sup> IEC Metric motors

# Variable Speed Operation

## VARIABLE SPEED INFORMATION

Marathon Motors Vector-Duty and Inverter-Duty motors, unless otherwise stated, are rated for continuous operation in a 40°C ambient and for altitudes up to 3300 feet (1000 meters) above sea level. Special application considerations, such as high or low ambient, intermittent ratings, high altitude, duty cycle rated, extended constant horsepower range, special base speed, voltage or frequency, or any other special requirements, should be reviewed by a factory representative.

It is the responsibility of the startup personnel during commissioning of the VFD/motor system to properly tune the drive to the motor for the specific application. The correct voltage boost and volts/hertz settings are application dependent and unique to each motor design. Procedures for these adjustments should be in your VFD user manual. Many Vector Duty and Inverter Duty motors in this catalog are equipped with thermostats; warranty coverage may be denied if they are not properly utilized.

**WARNING** Power factor correction capacitors should never be installed between the drive and the motor.



## INVERTER DUTY OR INVERTER RATED

"Inverter Duty" (often called "Inverter Rated") motors are suitable for use with Variable Frequency Drives, as long as operation is within the application guidelines published in this catalog. In general, Marathon Motors's three phase, general purpose, NEMA Design B motors are considered "Inverter Duty", and meet or exceed the requirements of NEMA MG1, Part 30. As required under Federal law, these motors comply with EPAAct efficiencies when operating from utility power.

Many of Marathon's motor product lines have been enhanced to facilitate reliable operation on today's variable speed drives, including wider constant torque speed range (up to 20:1) and improved insulation systems that withstand voltage spikes common with variable frequency operation.

Inverter Duty (Rated) motors are most often used in 10:1 speed range, variable torque or constant torque applications. A vector control is usually required for operation beyond 10:1 CT.

Refer to "Guidelines for Application of General Purpose, Single Speed Three Phase Motors on Variable Frequency Drives" in this section of this catalog for the allowable speed range and cable length restrictions (from VFD to motor). Additional detail regarding a specific product's capabilities is available on its catalog page, or by consulting your application engineer.

**VECTOR DUTY** – "Vector Duty" describes a class of motors that are used in conjunction with Open- (without encoder) or Closed-Loop (with encoder) Vector controls, that provide enhanced performance under low speed operating conditions, or in cases where torque (rather than speed) must be controlled. "Vector Duty" motors can be applied to Volts/Hertz (scalar) drives, as well.

Marathon Motors's "MAX" family, consisting of Blue Max®, Black Max® and microMAX™ motors, have been specifically designed for optimal operation on vector or volts/hertz controls. These motors feature a wide constant torque (up to 2000:1) and/or constant horsepower (up to 4:1) speed range and are performance-matched to all current technology IGBT drives. Vector Duty motors meet or exceed the requirements of NEMA MG1, Part 31, and are equipped with an enhanced insulation system (MAX GUARD® or CR<sup>200</sup>) to provide many years of trouble-free service. Consult the catalog page for each product's capabilities and features. As these motors are specifically designed for operation through an inverter, they are exempt from EPAAct legislation. Model numbers contain the letter "H" in the "Electrical Type" field.

**VARIABLE TORQUE LOADS** – Applications include fans, blowers and centrifugal pumps. Torque varies as the square of the speed, and horsepower as the cube of the speed. Operation below base speed significantly lightens the load on the motor. While most variable torque applications do not require the motor to operate below half speed, the motor is fully capable of operation to zero speed. Operation above base speed significantly adds to the load on the motor; therefore, a factory representative must review applications requiring variable torque above base speed. Refer to the application chart found on page 14 for use of general purpose three phase motors on variable frequency drives. Marathon's microMAX™, Black Max® or Blue Max® motors are not necessarily required for operation of variable torque loads. A bypass circuit is often employed in Variable Torque applications. If this device is intended to be used, selection of a NEMA Design B motor is recommended, to withstand the inrush current during across-the-line starting.

**CONSTANT TORQUE LOADS** – Applications include conveyors, elevators, hoists, extruders, positive displacement pumps, mixers and converting equipment. Torque remains constant throughout the range of operation, and extra care should be taken in the proper application of motors, especially at very low speeds. Most constant torque applications don't require operation below 10:1 (i.e. 6 Hz operation on a 60 Hz motor), but an increasing number of applications historically reserved for servo and/or stepper systems are being served with motors capable of operation beyond 20:1, up to 2000:1 (zero speed, constant torque). Refer to the application chart found on page 17 for use of general purpose three phase motors on variable frequency drives.

Continued on next page.

# Variable Speed Operation

## CONSTANT TORQUE LOADS (Cont'd.)

Applications requiring greater than 20:1 C.T. are ideal for microMAX™, Black Max® or Blue Max® motors. These motors provide full rated torque within their listed speed range, without exceeding a Class F temperature rating while under inverter power (many operate at Class B). Ratings in this catalog have been developed, based on extensive testing on IGBT inverters, set at a minimum 3 KHz (or equivalent) carrier frequency.

Vector Duty and Inverter Duty motors from Marathon Motors are designed for operation at 150% of rated load for one minute, up to the base speed of the motor (overload capability declines to 100% as the motor reaches maximum constant HP speed). These motors accommodate constant horsepower operation to 1-1/2 to 2 times base speed, subject to the motor's maximum safe mechanical speed limit. Refer to the Maximum Safe Mechanical Speed Chart, as well as the performance section for each motor's capability.

Motors rated for zero RPM continuous duty (1000:1 or 2000:1) must be powered by vector drives to produce rated torque without overheating. Optimum zero speed and low-speed full torque performance may require a closed loop vector drive (with encoder feedback).

**CONSTANT HORSEPOWER LOADS** – Applications include coil winders, band saws, grinders, and turret lathes. Operation requires the motor to deliver the same horsepower rating, regardless of shaft speed. Torque increases at low speed and decreases at higher speed. Most general purpose motors can deliver constant horsepower up to 1 1/2 times base speed (consult a factory representative to verify performance). However, many constant HP applications require operation to twice base speed, and some, such as coil winders, up to 4 times base speed. microMAX™, Black Max® and Blue Max® motors are designed for 1 1/2 to 2 times base speed, and the Wide CHP motors, found in Marathon's SB371 Catalog, deliver up to 4 times constant horsepower performance.

**BEARING CURRENTS** – As stated in NEMA MG1-31.4.4.3, to protect a motor from inverter-sourced shaft voltages, either both bearings must be insulated or the motor shaft must be effectively grounded. Marathon Motors offers several effective means to protect the bearings from inverter sourced EDM (electrical discharge machining). A Shaft Grounding device is standard in Blue Max® motors, in frame sizes 444T and larger. Insulating the motor bearings will not prevent damage to bearings of a connected load, and insulated couplings should be employed to protect the load. Adding a ground brush to a motor with insulated bearings will divert motor shaft currents and help protect the bearings of the connected load. At this time, UL policy prohibits the use of ground brushes or insulated bearings in Hazardous Locations (Div 1 & 2, Zones 1, 2, 21 & 22).

### The Marathon Solution to Bearing Currents

Any motor with a "-P" behind the catalog number and a "P" footnote features a current mitigation device.



**MOTOR GROUNDING** - Frames and accessories of all motors must be grounded in accordance with the National Electric Code (NEC) Article 430. Refer to NEC Article 250 for general information on grounding. Proper grounding of inverter-driven motors is essential to protect personnel and livestock from inverter-sourced common mode voltages, which may reach hazardous levels on the frame of ungrounded or poorly grounded motors.

**LOW INPUT VOLTAGE** – If, due to lower utility supply voltage, the input voltage from the VFD to the motor is lower than the motor's rated voltage, de-rating of the motor's base frequency, horsepower, full load RPM, and constant HP RPM is required. The revised values can be calculated by multiplying by the ratio of the voltage change. For example, to operate a 460 volt motor from an inverter fed by 50 or 60 HZ, 400 volt utility power, the multiplier is 400/460 or 0.87.

The VFD can be reprogrammed to match the new base point values, allowing the motor to provide rated torque at rated current from the new base speed down to its original minimum Constant torque speed. The motor's CHP range will begin at the new base frequency and will be shortened by the same ratio as described above.

**OVERSPEED CAPABILITY** – Maximum safe mechanical speed capability is a function of bearing size and type, lubrication, rotor balancing technique and specifications, air gap, enclosure, frame construction and connection to the driven load. In addition, consideration must be given to ambient noise levels, as operation above base speed will increase motor noise and vibration, and reduce bearing life. Under no circumstances should bearing hub temperature exceed 100°C. Belted loads should not exceed 60 Hz operating RPM by more than 25% (NEMA "TS" shafts are not suitable for belted loads). Due to external cooling fans, TEFC (and Explosion Proof Fan Cooled) motors are limited to 4000 RPM maximum speed.

Marathon Motors, through extensive testing in our state-of-the-art laboratory and in actual field experience, has developed a number of high speed motors whose maximum safe mechanical speed exceeds the values in the table below. The following table depicts maximum safe speed limits for continuous operation, direct-coupled, non-explosion proof motors, and does not imply constant horsepower capability. Please consult a factory representative for requirements beyond those listed, or for intermittent duty limits.

**Maximum Safe Mechanical Speed Limits  
(ODP, TENV, DPFV OR TEBC ENCLOSURES)  
60 Hz base frequency**

Frame Size	2-Pole	4, 6 or 8-Pole
56-184	7200	5400
213-256	5400	4200
284-286	5400	3600
324-326	4000	3600
364-365	4000	2800
404-449	3600	2800
5000 Fr	N/A	CALL
6800 Fr	N/A	CALL

# Variable Speed Operation

## OTHER APPLICATION CONSIDERATION

For proper selection, the following should be considered:

- Horsepower or torque requirements at various speeds.
- Desired speed range of the load and motor.
- Acceleration and deceleration rate requirements of the process being controlled.
- Starting requirements including the frequency of starting and a description of the load (reflected inertia at the motor, load torque during starting).
- Whether the application is a continuous process or duty cycle of starts, stops and speed changes.
- A general description of the type of application including the environment in which the VFD system components must operate (determines motor enclosure and/or explosion proof classification).
- Description of the available electrical power supply and wiring.
- Special performance requirements, if any.
- Whether the drive will be configured with a by-pass circuit. In case of its deployment, the motor will operate like its fixed speed counterpart and may require a NEMA B design which limits in-rush current, or selection of a larger motor starter or other protective circuitry.
- Load sharing
- Mounting and other mechanical considerations

## Typical Temperature Rise Of Various Enclosures

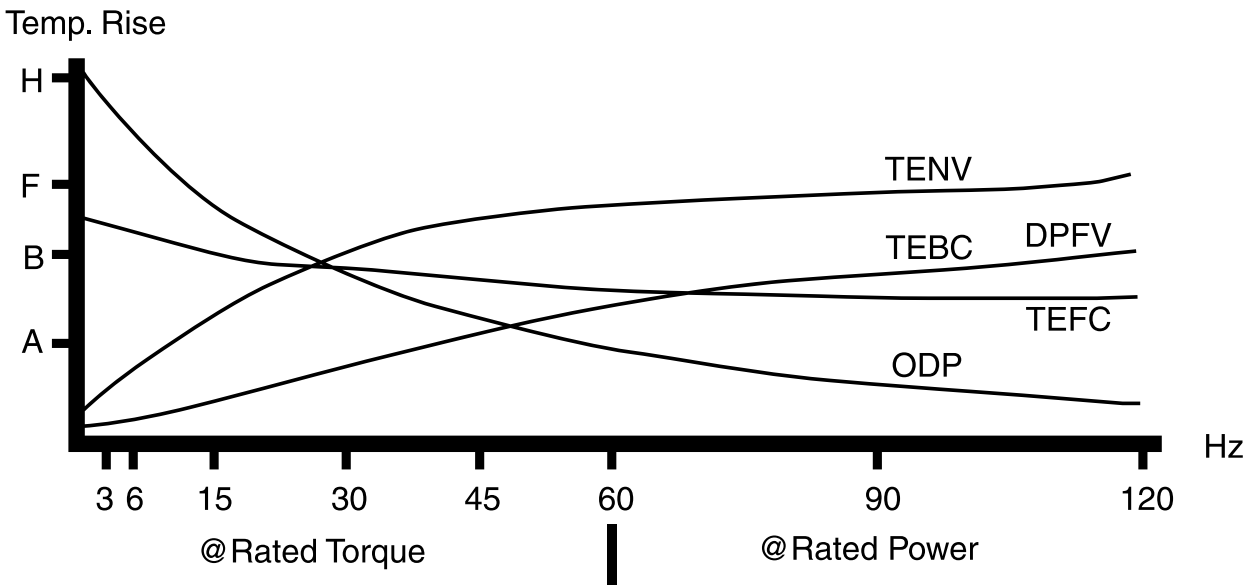

VARIABLE SPEED OPERATION

# General Purpose, Single Phase (NEMA Service Factor), Dripproof

## Features:

- Heavy gauge steel frame and base
- Ball bearings (except as noted)
- Economical split phase or capacitor start designs, as noted
- Service Factor, as noted
- UL Recognized and CSA Certified



## Rigid Base

HP	RPM	VOLTS	FRAME	OVER LOAD	CAT. NO.	MODEL NO.	STOCK	LIST PRICE	MULT. SYMB.	F.L. AMPS	WEIGHT	"C" DIM.	FOOT NOTES
1/6	1800	115	48	AUTO	4349	5KH39QN9537X	✓	\$143	F1	3.9	12	8.94	3,7,20
1/4	1800	115	48	NONE	4354	5KH39QN9538	✓	\$146	F1	5.1	13	8.94	3,7,20
	1800	115	48	NONE	H239	5KH33FN6	✓	\$197	F1	5.6	13	8.87	d,3,7,20
	1800	115	48	AUTO	4362	5KH39QN9686X	✓	\$151	F1	5.1	13	8.94	3,7,20
	1800	115/208-230	48	MANUAL	G078	048C17D2034	✓	\$202	F1	5.0/2.3-2.5	17	9.84	2,20
	1800	115/208-230	48	NONE	C147	5KC35JN10	✓	\$187	F1	5.2/2.7-2.6	16	9.25	2,7,20
	1800	115/208-230	48	AUTO	C148	5KC35JN10X	✓	\$253	F1	5.2/2.7-2.6	16	9.25	2,7,20
	1800	115/230	48	AUTO	C145	5KC35JN8X	✓	\$227	F1	5.2/2.6	16	9.57	d,2,7,20
	1500	110/220	48	NONE	C431	5KC36LN18	✓	\$275	F1	5.6/2.8	17	9.66	2,7,20,50
1/3	3600	115/208-230	48	NONE	G091	048C34D2025		\$161	F1	4.4/2.2-2.2	17	10.09	2,20
	1800	115/208-230	48	NONE	C153	5KC36LN30	✓	\$268	F1	6.0/3.2-3.0	18	9.66	2,7,20,68
	1800	115/208-230	48	AUTO	C154	5KC36LN30X	✓	\$280	F1	6.0/3.2-3.0	18	9.66	2,7,20,68
	1800	115/208-230	56	NONE	C158	5KC36LN7	✓	\$227	F1	6.0/3.2-3.0	18	10.32	2,7,20,68
	1800	100-120/200-240	56	NONE	E253	5KCR46JN0085	✓	\$327	F1	4.0-3.8/2.0-1.9	23	10.77	ES,1,20,68
	1800	115/208-230	56	AUTO	C159	5KC36LN7X	✓	\$235	F1	6.0/3.2-3.0	18	10.32	2,20,68
	1800	115/208-230	56	MANUAL	G095	056C17D2010	✓	\$242	F1	6.4/3.0-3.2	18	10.22	2,20
	1200	115/230	56	NONE	C1252	5KC49PN6070	✓	\$338	F1	8.6/4.3	89	11.48	2,20,68
1/2	3600	115/230	48	NONE	G1098	5KC36JN266	✓	\$180	F1	7.6/3.8	15	9.66	2,7,19
	3600	115	56	MANUAL	9031	5KC49MN2043Y	✓	\$215	F1	11.5	20	11.14	2,17
	3600	115/230	56	MANUAL	C1474	5KC37LN502Y	✓	\$265	F1	7.4/3.7	17	10.72	2,17
	3000	110/220	48	NONE	C459	5KC37MN96	✓	\$300	F1	7.8/3.9	20	10.06	2,7,19,50
	1800	115/230	48	NONE	C164	5KC37NN15	✓	\$332	F1	9.2/4.6	20	10.40	2,7,19
	1800	110-120/200-240	56	NONE	E262	5KCR46MN0092	✓	\$384	F1	5.8-5.6/2.9-2.8	27	10.77	ES,1,19,68
	1800	115/208-230	56	NONE	C167	5KC49GN0010	✓	\$253	F1	8.8/4.2-4.4	21	10.38	2,19
	1800	115/230	56	AUTO	C168	5KC49GN0010X	✓	\$277	F1	8.8/4.4	21	10.38	2,19
	1800	115/230	56	MANUAL	C169	5KC49GN0010Y	✓	\$284	F1	8.8/4.4	31	10.38	2,19
	1200	115/230	56	NONE	C1263	5KC48UN6073	✓	\$433	F1	9.4/4.7	34	12.76	2,19
3/4	3600	115/208-230	56	NONE	G915	056C34D2100	✓	\$233	F1	9.6/4.4-4.8	21	10.97	2,19
	3600	115	56	MANUAL	9032	5KC49MN2049Y	✓	\$250	F1	12.5	27	11.14	2,17
	3600	115/230	56	MANUAL	C1475	5KC37NN501Y	✓	\$321	F1	10.2/5.1	18	10.72	2,19
	1800	100-120/200-240	56	NONE	EG271	5KCR49PN0097	✓	\$482	F1	9.0-8.8/4.5-4.4	31	11.37	ES,1,19,68
	1800	115/208-230	56	NONE	C175	5KC46LN0153	✓	\$317	F1	13.2/6.2-6.6	25	10.78	2,19
	1800	115/230	56	AUTO	C176	5KC46LN0153X	✓	\$366	F1	13.2/6.6	24	10.78	2,19
	1800	115/208-230	56	MANUAL	G919	056B17D2010	✓	\$346	F1	11.0/5.5-5.5	26	11.47	1,19
	1800	115/208-230	56	MANUAL	C1298	5KC46NN0758Y	✓	\$346	F1	11.2/5.8-5.6	26	10.34	2,19
	1800	115/230	56	MANUAL	C177	5KC46LN0153U	✓	\$388	F1	13.2/6.6	24	10.78	d,2,19
	1200	115/230	56	NONE	C178	5KCR49WN6075	✓	\$554	F1	12.6/6.3	44	13.96	ES,1,18
1	3600	115/208-230	56	NONE	C179	5KC38RN60	✓	\$264	F1	12.4/6.4-6.2	24	11.04	2,19
	3600	115/208-230	56	AUTO	C180	5KC38RN60X	✓	\$338	F1	12.4/6.4-6.2	24	11.04	2,19
	3600	115/230	56	MANUAL	9033	5KC49NN2050Y	✓	\$285	F1	16.0/8.0	23	11.14	d,2,17
	3600	115/208-230	56	MANUAL	D010	056B34D2029	✓	\$287	F1	10.6/5.5-5.3	23	11.72	1,18
	3600	115/230	56	MANUAL	C702	5KC38RN4153Y	✓	\$407	F1	12.8/6.5	20	11.04	d,2,18
	1800	100-120/200-240	56H	NONE	E280	5KCR48UN0104	✓	\$343	F1	11.8-11.4/5.9-5.7	39	12.66	ES,1,18
	1800	115/208-230	56	NONE	C181	5KC49PN0161	✓	\$343	F1	13.6/6.7-6.8	31	11.38	2,18
	1800	115/208-230	56	AUTO	C182	5KC49PN0161X	✓	\$365	F1	13.6/6.6-6.8	31	11.38	2,18
	1800	115/230	56	MANUAL	C1480	5KC49PN0161U	✓	\$379	F1	13.6/6.8	31	11.38	2,18
	1800	115/208-230	143T	NONE	C188	5KC49PN0162	✓	\$343	S1	13.6/6.7-6.8	31	11.77	2,11,18
	1200	115/230	56H	NONE	C183	5KCR49QN6076	✓	\$499	F1	12.6/6.3	54	14.93	ES,1,18
	1200	115/230	182T	NONE	I141	182TCDR17079	✓	\$574	S1	15.0/7.5	87	15.72	13,18

SINGLE PHASE

Continued on next page.

# General Purpose, Single Phase

## (NEMA Service Factor), Dripproof



### Rigid Base

HP	RPM	VOLTS	FRAME	OVER LOAD	CAT. NO.	MODEL NO.	STOCK	LIST PRICE	MULT. SYMB.	F.L. AMPS	WEIGHT	"C" DIM.	FOOT NOTES
1 1/2	3600	115/208-230	56	NONE	G937	056B34D2026	✓	\$353	F1	14.8/8.0-7.4	25	11.72	1,18
	3600	115/230	56	MANUAL	C1477	5KC49PN2144Y	✓	\$463	F1	16.8/8.4	29	11.82	d,2,18
	3600	115/230	56	MANUAL	C704	5KC49PN2521Y	✓	\$369	F1	21.3 / 10.6	31	11.91	2,18
	3600	115/208-230	143T	NONE	I101	143TCDR5303		\$366	S1	18.8/9.7-9.4	30	10.99	2,14,18
	1800	115/230	56	NONE	C1299	5KCR48WN0756Y		\$443	F1	13.4/6.7	35	12.45	ES,1,110
	1800	115/208-230	56H	MANUAL	G951	056C17D5308	✓	\$443	F1	18.0/9.3-9.0	39	12.44	2,14,18
	1800	115/208-230	56H	NONE	C185	5KCR49SN0068	✓	\$408	F1	18.2/9.1-9.1	35	11.90	ES,1,18
	1800	115/208-230	56H	AUTO	C186	5KCR49SN0068X	✓	\$424	F1	18.2/9.1	35	11.90	ES,1,18
	1800	115/208-230	145T	NONE	C191	5KCR49SN0065	✓	\$415	S1	18.2/9.1-9.1	35	12.30	ES,1,18
	1200	115/230	184T	NONE	I142	184TCDR7076		\$714	S1	23.0/11.5	72	15.72	2,13,18
2	3600	115/230	56	NONE	C187	5KC48TN2169	✓	\$424	F1	21.2 / 10.6	38	12.66	2,18
	3600	115/230	56	MANUAL	C703	5KC49RN2520Y	✓	\$579	F1	23.8/11.8	33	11.91	2,18
	3600	115/208-230	145T	NONE	I102	145TBDR5302	✓	\$436	S1	19.2/10.5-9.6	35	11.49	1,18
	1800	115/208-230	56HZ	NONE	C193	5KCR49WN0270	✓	\$433	F1	22.0/10.9-11.0	44	14.33	ES,1,11,18
	1800	115/208-230	56HZ	AUTO	CG381	5KCR49WN0270T	✓	\$556	F1	22.0/10.9-11.0	44	14.33	ES,1,11,18
	1800	115/208-230	145T	MANUAL	I127	145TBDR5337	✓	\$534	S1	18.8/10.2-9.4	48	13.49	1,11,18
	1800	115/208-230	182T	NONE	I112A	182TCDW7026	✓	\$484	S1	23.0/12.3-11.5	62	13.19	2,13,18
	1200	115/208-230	213T	NONE	I143	213TCDW7076	✓	\$887	S1	30.0/15.5-15.0	138	16.55	2,18
3	3600	230	56	MANUAL	9036	5KCR48UN2653Y	✓	\$602	F1	14.5	40	12.64	ES,1,17
	3600	115/230	145T	NONE	C194	5KCR48TN8062	✓	\$610	S1	29.4/14.7	38	13.13	ES,1,18
	3600	115/208-230	182T	NONE	I103A	182TCDW7001	✓	\$544	S1	32.0/17.1-16.1	62	13.69	2,13,18
	1800	115/208-230	184T	NONE	I113A	184TCDW7026	✓	\$566	S1	33.5/17.4-16.8	78	14.21	2,13,18
	1200	230	215T	NONE	I144	215TBDW7079		\$1,222	S1	16.0	134	18.05	1,18
5	3600	230	56H	MANUAL	D017	056B34D5302	✓	\$640	F1	20.0	55	13.94	1,5,18
	3600	208-230	184T	NONE	I104A	184TBDW17008	✓	\$731	S1	24.0-22.0	79	14.69	2,13,18
	1800	208-230	184T	NONE	I114A	184TBDW7026	✓	\$686	S1	23.0-21.0	82	14.71	1,13,18
	1800	208-230	213T	NONE	I117	213TCDW7026		\$934	S1	30.5-28.0	108	16.55	2,18
7 1/2	3600	208-230	184T	NONE	I108A	184TBDW7001	✓	\$770	S1	34.0-31.0	103	16.69	1,13,18
	3600	208-230	213T	NONE	I105	213TCDW7001	✓	\$1,041	S1	40.0-37.0	105	16.55	2,18,F
	1800	208-230	215T	NONE	I115	215TBDW7026	✓	\$1,027	S1	37.2-34.5	115	18.05	1,18
10	3600	208-230	215T	NONE	I106	215TCDW17002	✓	\$1,335	S1	51.0-46.0	193	18.05	2,18,F
	1800	208-230	215T	NONE	I116	215TBDW7028	✓	\$1,322	S1	49.0-44.0	140	19.30	1,7,18

SINGLE PHASE

### Extended Thru-Bolts, Split Phase - Steel Endshields

HP	RPM	VOLTS	FRAME	OVER LOAD	CAT. NO.	MODEL NO.	STOCK	LIST PRICE	MULT. SYMB.	F.L. AMPS	WEIGHT	"C" DIM.	FOOT NOTES
1/4	1800	115	48Z	NONE	H901	5KH32DNA612	✓	\$126	F1	5.1	11	9.83	9,18,28
	1800	115	48Z	AUTO	H902	5KH32DNA612X	✓	\$131	F1	5.1	11	9.83	9,18,28
1/3	1800	115	48Z	NONE	H903	5KH32FNA611	✓	\$130	F1	5.5	14	9.83	9,18,28
	1800	115	48Z	AUTO	H904	5KH32FNA611X	✓	\$135	F1	5.5	12	9.83	9,18,28
1/2	1800	115	56Z	NONE	H905	5KH36JNA769	✓	\$153	F1	8.1	16	10.89	10,18,28
	1800	115	56Z	AUTO	H906	5KH36JNA769X	✓	\$158	F1	8.1	16	10.89	10,18,28
3/4	1800	115	56Z	NONE	H907	5KH37NNA768	✓	\$187	F1	11.2	18	11.29	10,17
	1800	115	56Z	AUTO	H908	5KH37NNA768X	✓	\$192	F1	11.2	33	11.29	10,17



# Special Purpose, Single Phase (1.0 Service Factor), Dripproof

## Features:

- Heavy gauge steel frame and base
- Ball bearings (except as noted)
- Economical split phase or capacitor start designs, as noted
- 1.0 Service Factor
- UL Recognized and CSA Certified



## Rigid Base

HP	RPM	VOLTS	FRAME	OVER LOAD	CAT. NO.	MODEL NO.	STOCK	LIST PRICE	MULT. SYMB.	F.L. AMPS	WEIGHT	"C" DIM.	FOOT NOTES
1/4	1800	115	48	NONE	4351	5KH39QN9542	✓	\$112	F1	5.7	13	8.94	d,3,7
	1800	115	48	NONE	S003	048S17D2089	✓	\$112	F1	5.7	12	9.09	3,7
	1500	110/220	48	AUTO	H689	5KH35JN603X	✓	\$230	F1	5.2/2.6	15	9.23	3,7,50
1/3	1800	115	48	AUTO	4380	5KH39QN9681X	✓	\$161	F1	6.2	14	8.94	d,3,7
	1800	115	48	AUTO	S026	048S17D2113	✓	\$130	F1	6.6	14	9.34	3,7
	1800	115	48	NONE	4368	5KH39QN9397	✓	\$125	F1	6.2	14	8.94	3,7
	1800	115	48	NONE	S006	048S17D2090	✓	\$125	F1	6.6	14	9.34	3
	1800	115	48	NONE	H229	5KH35HN9	✓	\$204	F1	6.8	15	9.25	d,3,7
	1800	115/230	48	NONE	S010	048C17D2023	✓	\$169	F1	7.0/3.5	15	9.34	2
	1800	115/230	48	MANUAL	S030	048C17D2027	✓	\$202	F1	7.0/3.5	16	9.34	2
	1800	115/230	48	AUTO	S011	048C17D2024	✓	\$177	F1	7.0/3.5	16	9.34	
	1800	230	48	NONE	4373	5KH39QN9543	✓	\$176	F1	3.3	14	8.94	3,7
	1800	115	48Z	NONE	4376	5KH39QN9547		\$168	F1	6.2	15	10.36	3,7
	1800	115	56Z	NONE	4372	5KH39QN9546	✓	\$172	F1	6.2	15	8.94	3,7
	1800	115	56Z	NONE	H676	5KH35GNA229	✓	\$204	F1	6.2	14	9.57	3,7
	1800	115/230	56	MANUAL	CG105	5KC35JN27Y		\$242	F1	6.6/3.3	16	9.89	2
	1500	110/220	48	AUTO	H691	5KH36LN488X	✓	\$246	F1	7.0/3.5	17	9.66	3,7
	1/2	1800	115	48	NONE	H696	5KH36LNA504	✓	\$243	F1	8.3	15	9.68
1800		115	56	AUTO	9029	5KC49NN0221X	✓	\$219	F1	8.7	20	11.14	2
1800		115	56	AUTO	S027	056S17D2066	✓	\$166	F1	9.2	19	10.22	3
1800		115	56	NONE	H230	5KH39QN9091		\$159	F1	8.3	16	10.32	3,7
1800		115	56	NONE	S022	056S17D2046	✓	\$159	F1	9.2	17	10.22	3
1800		115/230	56	NONE	S012	056C17D2098	✓	\$208	F1	9.2/4.6	18	10.22	2
1800		115/230	56	MANUAL	S033	056C17D2064	✓	\$242	F1	9.2/4.6	18	10.22	2
1800		115/230	56	AUTO	S013	056C17D2051	✓	\$217	F1	9.2/4.6	18	10.22	2
1800		115/230	56Z	NONE	CG393	5KC36MN20	✓	\$292	F1	8.2/4.1	17	12.30	2
3/4		3600	115/230	48	NONE	CG111	5KC37LN91	✓	\$416	F1	11.2/5.6	19	10.06
	1800	115/230	56	MANUAL	S036	056C17D2067	✓	\$284	F1	10.4/5.2	24	11.97	2
	1800	115/230	56	AUTO	S015	056C17D2055	✓	\$259	F1	10.4/5.2	24	11.97	2
	1800	115/230	56	NONE	S014	056C17D2054	✓	\$249	F1	10.4/5.2	24	11.97	2
1	3600	115/230	56Z	NONE	C449	5KC37NN160	✓	\$327	F1	13.4/6.7	20	12.60	2
	1800	115/230	56	MANUAL	S039	056C17D5320	✓	\$369	F1	13.6/6.8	27	10.94	2
	1800	115/230	56	AUTO	S038	056C17D5343	✓	\$343	F1	13.6/6.8	27	10.94	2
	1800	115/230	56	NONE	S037	056C17D5319	✓	\$335	F1	13.6/6.8	28	10.94	2
1 1/2	3600	115/230	56	MANUAL	9034	5KC49NN2044Y	✓	\$281	F1	19.0/9.5	29	11.14	2
2	3600	115/230	56	MANUAL	9035	5KCR48TN2650Y	✓	\$462	F1	17/8.5	38	12.76	ES,1
3	3600	208-230	145T	NONE	1145	145TBD5303		\$472	S1	13.5/12.5	40	12.49	1
5	3600	230	56H	MANUAL	9038	5KCR49Z2722Y	✓	\$640	F1	21.0	49	15.04	ES,1

SINGLE PHASE

# General Purpose, Single Phase (NEMA Service Factor), Dripproof

## Features:

- Heavy gauge steel frame and base
- Ball bearings (except as noted)
- Thermal protection, as noted
- Capacitor start design for high starting torque
- Capacitor start/capacitor run design for higher efficiency, as noted
- 48Y and 48YZ have 48/56 Fr mounting holes
- Service Factor, as noted
- UL Recognized and CSA Certified



## Resilient Base

HP	RPM	VOLTS	FRAME	OVER LOAD	CAT. NO.	MODEL NO.	STOCK	LIST PRICE	MULT. SYMB.	F.L. AMPS	WEIGHT	"C" DIM.	FOOT NOTES	
1/4	1800	115	48	AUTO	CG201	5KC35JN12X	✓	\$223	F1	5.2	16	9.57	d,4,7,20	
	1800	115	48	NONE	C200	5KC35JN12	✓	\$218	F1	5.2	16	9.57	d,7,20	
	1800	115/230	48	NONE	G1114	5KC35JN7	✓	\$173	F1	5.2/2.6	16	9.57	7,20	
	1800	115/230	48	AUTO	G1115	5KC35JN7X	✓	\$183	F1	5.2/2.6	16	9.57	7,20	
	1500	110/220	48	AUTO	C460	5KC36LN19X	✓	\$281	F1	5.6/2.8	18	10.00	7,20,50	
1/3	3600	115/230	48	AUTO	C208	5KC35FN51X	✓	\$237	F1	6.8/3.4	15	9.57	7,20	
	1800	100-120/200-240	56	AUTO	E254	5KCR46JN0086X	✓	\$337	F1	4.0-3.8/2.0-1.9	25	10.77	ES,1,20,68	
	1800	115/208-230	48	NONE	C209	5KC36LN26	✓	\$269	F1	6.0/3.2-3.0	18	10.00	7,20,68	
	1800	115/208-230	48	AUTO	C210	5KC36LN26X	✓	\$284	F1	6.0/3.2-3.0	18	10.00	7,20,68	
	1800	115/230	56	AUTO	G135	056C17D2088	✓	\$221	F1	6.4/3.2	18	10.22	d,20	
	1800	115/208-230	56	NONE	C215	5KC36LN1	✓	\$292	F1	6.0/3.2-3.0	18	10.32	20,68	
	1800	115/208-230	56	AUTO	C216	5KC36LN1X	✓	\$241	F1	6.0/3.2-3.0	18	10.32	20,68	
	1500	110/220	56	AUTO	C457	5KC37NN14T	✓	\$341	F1	7.4/3.7	20	10.72	20,50	
	1200	115/230	56	NONE	C1258	5KC49PN6051	✓	\$396	F1	8.6/4.3	28	11.38	20	
	1200	115/230	56	AUTO	C548	5KC49PN6051X	✓	\$407	F1	8.6/4.3	28	11.38	20	
1/2	3600	115/208-230	48	AUTO	C1152	5KC39QN3220X	✓	\$175	F1	8.2/3.9-4.1	19	11.00	7,19	
	1800	100-120/200-240	56	AUTO	E263	5KCR46MN0054X	✓	\$403	F1	5.8-5.6/2.9-2.8	27	10.77	ES,1,19,68	
	1800	115/208-230	56	NONE	B1316	5KC49GN0001	✓	\$259	F1	8.8/4.2-4.4	21	10.38	19	
	1800	115/208-230	56	AUTO	C1153	5KC49GN0022X	✓	\$293	F1	8.6/4.1-4.3	21	10.38	19	
	1800	115/208-230	56	AUTO	B317	056C17D2072	✓	\$299	F1	8.0/4.1-4.0	20	10.47	CF,19,31	
	1800	115/230	56	AUTO	CG223	5KC49GN0001X	✓	\$314	F1	8.8/4.4	21	10.38	d,19	
	1800	115/230	56	AUTO	D111	056C17D2079	✓	\$263	F1	7.2/3.6	20	10.72	19	
	1800	115/230	56	AUTO	G151	056C17D2025	✓	\$263	F1	8.6/4.3	24	11.72	d,19	
	1200	115/230	56	NONE	C1264	5KC48UN6052	✓	\$564	F1	9.4/4.7	40	12.76	19	
	1200	115/230	56	AUTO	C552	5KC48UN6052X	✓	\$576	F1	9.4/4.7	36	12.76	19	
	3/4	3600	115/208-230	48	AUTO	C1154	5KC38NN413X	✓	\$322	F1	10.0/4.9-5.0	17	11.00	7,19
		3600	115/208-230	56	AUTO	C1155	5KC38NN410X	✓	\$228	F1	10.0/4.9-5.0	17	11.32	19
		1800	100-120/200-240	56	AUTO	EG272	5KCR49PN0098X	✓	\$501	F1	9.0-8.8/4.5-4.4	31	11.37	ES,1,17,68
1800		115/208-230	56	NONE	G156	056B17D2012	✓	\$324	F1	11.0/5.5-5.5	26	11.47	1,19	
1800		115/208-230	56	AUTO	C1156	5KC46LN0149X	✓	\$353	F1	13.3/6.5-6.6	27	10.78	19	
1800		115/208-230	56	AUTO	B319	056C17D2074	✓	\$363	F1	10.0/5.2-5.0	23	11.72	CF,19,31	
1800		115/208-230	56	NONE	CG230	5KC46LN0158	✓	\$326	F1	13.2/6.2-6.6	25	10.78	19	
1800		115/208-230	56	NONE	B318	056C17D2073	✓	\$337	F1	10.0/5.2-5.0	24	11.72	CF,19,31	
1800		115/208-230	56	AUTO	C138	5KC46JN0002X	✓	\$352	F1	11.4/5.6-5.7	23	10.78	19	
1800		115/230	56	AUTO	D1113	5KC46LN0158X	✓	\$325	F1	13.2/6.6	25	10.78	d,19	
1500		110/220	56	AUTO	C1187	5KC49NN0224X	✓	\$463	F1	12.2/6.1	28	11.38	19,50	
1200		115/230	56	NONE	CG232	5KCR49WN6077	✓	\$652	F1	12.6/6.3	42	13.96	1,18	
1		3600	115/208-230	56	AUTO	C1157	5KC39RN383X	✓	\$284	F1	13.4/6.7-6.6	25	11.90	19
		3600	115/208-230	56	AUTO	D118	056C34D2106	✓	\$266	F1	12.0/6.2-6.0	25	12.22	18
	1800	100-120/200-240	56H	AUTO	E281	5KCR48UN0105X	✓	\$526	F1	11.8-11.4/5.9-5.7	40	12.65	ES,1,18,68	
	1800	115/208-230	56	AUTO	C1158	5KC49PN0164X	✓	\$369	F1	14.7/7.2-7.4	29	11.38	18	
	1800	115/208-230	56	NONE	C235	5KC49PN0155	✓	\$344	F1	13.6/6.7-6.8	31	11.38	5,18	
	1800	115/230	56	AUTO	CG236	5KC49PN0155X	✓	\$418	F1	13.6/6.8	30	11.38	d,18	

Continued on next page.

# General Purpose, Single Phase (NEMA Service Factor), DripProof

## Resilient Base

HP	RPM	VOLTS	FRAME	OVER LOAD	CAT. NO.	MODEL NO.	STOCK	LIST PRICE	MULT. SYMB.	F.L. AMPS	WEIGHT	"C" DIM.	FOOT NOTES
1 1/2	3600	115/208-230	56	AUTO	D115	056B34D2027		\$370	F1	13.4/7.4-6.7	28	11.72	1,18
	1800	115/208-230	56H	NONE	B336	056C17D5347	✓	\$413	F1	18.0/9.3-9.	39	12.85	5,18,32
	1800	115/208-230	56H	AUTO	CG239	5KCR49SN0012X	✓	\$491	F1	18.2/9.1	35	11.91	ES,1,5,18
	1800	115/208-230	56H	AUTO	C1160	5KCR49SN0150X	✓	\$429	F1	16.4/8.4-8.2	35	11.90	ES,1,18
	1800	115/208-230	145T	NONE	I146	145TCDR5331	✓	\$419	S1	18.0/9.3-9.	42	13.22	18,32
2	3600	115/208-230	56H	AUTO	K152	056B34D5320	✓	\$450	F1	19.2/10.5-9.6	33	11.85	1,5,18
	3600	115/208-230	56H	AUTO	C1161	5KCR49RN2148T	✓	\$451	F1	19.6/10.4-9.8	33	11.91	ES,1,5,110
	1800	115/208-230	56H	AUTO	B352	056B17D5331	✓	\$547	F1	21.0/11.3-10.5	50	13.85	1,5,18
	1800	115/208-230	145T	NONE	I147	145TBDR5345	✓	\$440	S1	21/11.3-10.5	49	14.22	1,18

## Two Speed, Variable Torque, Resilient Base

HP	RPM	VOLTS	FRAME	OVER LOAD	CAT. NO.	MODEL NO.	STOCK	LIST PRICE	MULT. SYMB.	F.L. AMPS	WEIGHT	"C" DIM.	FOOT NOTES
1/2-1/6	1800/1200	115	56	AUTO	C419	5KC49PN3027X	✓	\$499	F1	8.2/3.9	28	11.38	19
3/4-1/4	1800/1200	115	56	AUTO	C474	5KCR49PN3011X	✓	\$545	F1	9.0/6.4	31	11.48	ES,1,19
	1800/1200	115	56	NONE	C420	5KCR49PN3011	✓	\$463	F1	9.0/6.4	31	11.48	ES,1,19
	1800/1200	208-230	56	AUTO	C486	5KCR49PN3012X	✓	\$472	F1	4.3-4.4/3.1-3.2	38	11.48	ES,1,19
1 1/3	1800/1200	115	56	AUTO	C1478	5KCR49SN3009X	✓	\$601	F1	10.8/7.4	30	12.01	ES,1,18
	1800/1200	115	56	NONE	C475	5KCR49SN3009	✓	\$578	F1	10.8/7.4	35	12.01	ES,1,18
	1800/1200	208-230	56	NONE	C476	5KCR49SN3010	✓	\$601	F1	5.3-5.4/3.6-3.7	35	12.01	ES,1,18
	1800/1200	208-230/190-220	56H	AUTO	C1479	5KCR48TN3084X	✓	\$613	F1	5.3-5.4/3.6-3.7	36	12.54	ES,1,17

## Special Purpose, Single Phase (1.0 Service Factor), DripProof

Features:

- Heavy gauge steel frame and base
- Ball bearings (except as noted)
- 1.0 Service Factor
- Economical split phase or capacitor start designs, as noted
- 48Y and 48YZ have 48/56 Fr mounting holes
- UL Recognized and CSA Certified



## Resilient Base

HP	RPM	VOLTS	FRAME	OVER LOAD	CAT. NO.	MODEL NO.	STOCK	LIST PRICE	MULT. SYMB.	F.L. AMPS	WEIGHT	"C" DIM.	FOOT NOTES
1/4	1800	115	48	AUTO	S103	048S17D2091		\$125	F1	5.7	13	9.06	3,7,31
	1800	115	48	NONE	S102	048S17D2042	✓	\$119	F1	5.7	13	9.06	3,7
	1800	115/230	48	AUTO	S119	048C17D2046	✓	\$173	F1	6.2/3.1	13	9.06	2,7
	1800	115/230	48	NONE	S118	048C17D2045	✓	\$164	F1	6.2/3.1	14	9.06	2,7
	1800	115	48	NONE	H675	5KH33FNA230	✓	\$197	F1	5.0	14	9.19	d,3,7
	1800	115	48Z	AUTO	S126	048S17D2104	✓	\$125	F1	5.3	14	9.72	3,53
	1800	115	56Z	AUTO	4364	5KH39QN5541X	✓	\$169	F1	5.7	13	9.19	3,4,7
	1800	115	56Z	NONE	4359	5KH39QN5523	✓	\$165	F1	5.7	13	9.19	3,4,7
	1500	220	48	NONE	H645	5KH39QNB810	✓	\$223	F1	3.4	14	9.57	3,7,50
	1500	110/220	56Z	AUTO	HG690	5KH35JN602X	✓	\$237	F1	5.2/2.6	15	9.51	3,7,50

Continued on next page.

# Special Purpose, Single Phase (1.0 Service Factor), Dripproof

## Resilient Base

HP	RPM	VOLTS	FRAME	OVER LOAD	CAT. NO.	MODEL NO.	STOCK	LIST PRICE	MULT. SYMB.	F.L. AMPS	WEIGHT	"C" DIM.	FOOT NOTES	
1/3	1800	115	48	NONE	4369	5KH39QN5508	✓	\$139	F1	6.2	14	8.94	3,7	
	1800	115	48	NONE	S106	048S17D2093	✓	\$141	F1	6.5	14	9.31	3,7,31,CF	
	1800	115/230	48	AUTO	C129	5KC35JN23X	✓	\$183	F1	6.4/3.2	16	9.57	2,7	
	1800	115/230	48	AUTO	S111	048C17D2029	✓	\$183	F1	7.0/3.5	16	9.31	2,7	
	1800	115/230	48	NONE	S110	048C17D2028	✓	\$173	F1	7.0/3.5	16	9.31	2,7	
	1800	115	48	AUTO	4310	5KH39QN5508X	✓	\$137	F1	6.2	14	8.94	3,7	
	1800	115	48Y	AUTO	S127	048S17D2105	✓	\$137	F1	6.6	14	9.72	3,5,3	
	1800	115	48	NONE	H674	5KH35JNA231	✓	\$212	F1	6.6	15	9.57	3,7	
	1800	115	56Z	NONE	4377	5KH39QN5524	✓	\$180	F1	6.2	15	9.19	3,7	
	1800	115	56Z	AUTO	4381	5KH39QN5528X	✓	\$184	F1	6.2	15	9.19	3,7	
	1800	115	56Z	AUTO	4776	5KH39QN5539T	✓	\$184	F1	6.2	16	9.19	d,3,7,57	
	1800	230	48	NONE	4371	5KH39QN5529	✓	\$180	F1	3.3	14	8.94	3,7	
	1800	230	48	AUTO	4311	5KH39QN5529X	✓	\$184	F1	3.3	14	8.93	3,7	
	1500	110/220	56Z	AUTO	HG692	5KH36LN489X	✓	\$254	F1	7.0/3.5	17	9.94	3,50	
	1500	220	56Z	NONE	H673	5KH33KN5594	✓	\$242	F1	3.5	17	9.19	3,7,50	
	1/2	1800	115	48Z	AUTO	HG710	5KH33JNA511T	✓	\$166	F1	7.9	15	9.93	3,9
		1800	115	48Z	AUTO	S128	048S17D2106	✓	\$166	F1	9.2	17	10.22	3,5,3
		1800	115	56	NONE	S120	056S17D2023	✓	\$164	F1	9.2	18	10.22	3,31
		1800	115	56Z	AUTO	4778	5KH39QN9639T	✓	\$254	F1	8.3	20	9.57	3,7
		1800	115/230	56Z	AUTO	S113	056C17D2099	✓	\$221	F1	9.1/4.5	19	10.22	2
1800		115/230	56	NONE	S112	056C17D2097	✓	\$213	F1	9.1/4.5	19	10.22	2	
1800		115/230	48	AUTO	C133	5KC36MN27X	✓	\$308	F1	8.2/4.1	19	10.00	2,7	
1800		230	56	AUTO	4602	5KH39QN9518X	✓	\$275	F1	4.2	19	10.32	3	
1800		230	56	NONE	4387	5KH39QN9684	✓	\$267	F1	4.2	19	10.32	3	
1500		110/220	56	AUTO	H693	5KH46JN0329X	✓	\$283	F1	9.2/4.6	23	10.55	3	
3/4	1800	115/230	56	NONE	S114	056C17D2060	✓	\$253	F1	10.4/5.2	25	11.97	2	
	1800	115	56	NONE	4422	5KH39QN9687	✓	\$314	F1	11.2	21	10.72	3	
	1800	115/230	56	AUTO	C1483	5KC46LN0254X	✓	\$263	F1	13.2/6.6	25	10.78	2	
	1800	115/230	56	AUTO	S115	056C17D2061	✓	\$263	F1	10.4/5.2	25	11.97	2	
1	1800	115/230	56	AUTO	S117	056C17D5340	✓	\$348	F1	13.6/6.8	28	11.35	2	
	1800	115/230	56	NONE	S116	056C17D5339	✓	\$339	F1	13.6/6.8	29	11.35	2	

SINGLE PHASE

# General Purpose, Single Phase (NEMA Service Factor), Dripproof

## Features:

- Ball bearings mechanically locked on shaft end (excludes 5K models)
- Heavy gauge steel frame and base
- Capacitor start design for high starting torque
- Capacitor start/capacitor run design for higher efficiency, as noted
- Service Factor, as noted
- UL Recognized and CSA Certified



## C-Face Footless

HP	RPM	VOLTS	FRAME	OVER LOAD	CAT. NO.	MODEL NO.	STOCK	LIST PRICE	MULT. SYMB.	F.L. AMPS	WEIGHT	"C" DIM.	FOOT NOTES
1/4	1800	115/208-230	56C	NONE	G212	056C17D2084	✓	\$202	F1	5.0/2.3-2.5	17	10.69	20
	1800	115/208-230	56C	AUTO	C354	5KC35JN70X	✓	\$265	F1	5.2/2.7-2.6	15	9.61	20
1/3	3600	115/208-230	56C	NONE	G216	056C34D2117	✓	\$173	F1	4.4/2.2-2.2	17	10.19	20
	1800	100-120/200-240	56C	NONE	E251	5KCR46JN0084	✓	\$390	F1	4.0-3.8/2.0-1.9	23	10.77	ES,1,20,68
	1800	115/208-230	56C	AUTO	C356	5KC36LN83X	✓	\$307	F1	6.0/3.2-3.0	16	10.35	20,68
1/2	1800	115/208-230	56C	NONE	G230	056C17D2085	✓	\$237	F1	6.4/3.0-3.2	17	10.69	20
	3600	115/208-230	56C	NONE	G232	056C34D2108	✓	\$191	F1	8.4/3.8-4.2	17	10.69	19
	1800	100-120/200-240	56C	NONE	E260	5KCR46MN0091	✓	\$445	F1	5.8-5.6/2.9-2.8	25	10.77	ES,1,19,68
	1800	115/208-230	56C	NONE	G234	056C17D2044	✓	\$279	F1	8.6/4.1-4.3	21	11.19	19
	1800	115/230	56C	AUTO	C359	5KC49GN0009X	✓	\$348	F1	8.8/4.4	21	10.38	19
3/4	1200	115/208-230	56C	NONE	G278	056C11D5304	✓	\$446	F1	10.6/5.1-5.3	32	11.94	19
	1200	115/230	56C	NONE	C1422	5KC48UN6072	✓	\$483	F1	9.4/4.7	40	12.61	2,19
	3600	115/208-230	56C	NONE	G238	056C34D2101	✓	\$245	F1	9.6/4.4-4.8	20	10.94	19
	1800	100-120/200-240	56C	NONE	E269	5KCR49PN0096	✓	\$482	F1	9.0-8.8/4.5-4.4	31	11.38	ES,1,19,68
1	1800	115/230	56C	AUTO	CG362	5KC46LN0159X	✓	\$419	F1	13.2/6.6	24	10.78	19
	1800	115/208-230	56C	NONE	G250	056B17D2011	✓	\$342	F1	11.0/5.5-5.5	25	11.72	1,19
	3600	115/208-230	56C	NONE	G254	056B34D2031	✓	\$281	F1	10.6/5.5-5.3	23	11.68	1,19
	1800	100-120/200-240	56C	NONE	E278	5KCR48UN0103	✓	\$555	F1	11.8-11.4/5.9-5.7	37	12.65	ES,1,18,68
	1800	115/230	56C	AUTO	CG363	5KC49PN0163X	✓	\$468	F1	13.6/6.8	24	11.38	18
	1800	115/208-230	56C	NONE	G256	056C17D5310	✓	\$367	F1	13.4/6.8-6.7	29	11.44	18
1 1/2	3600	115/208-230	56C	NONE	G258	056B34D2023		\$365	F1	14.2/7.7-7.1	26	11.68	1,18
	1800	115/208-230	56C	NONE	G270	056C17D5311	✓	\$427	F1	18.0/9.3-9.0	39	12.44	18
2	3600	115/208-230	56C	NONE	G272	056B34D5319	✓	\$447	F1	19.2/10.5-9.6	32	11.44	1,18
	1800	115/208-230	56C	NONE	G274	056B17D5303	✓	\$521	F1	21.0/11.3-10.5	47	13.44	1,18
3	3600	115/208-230	182TC	NONE	C173	182TCDR8007		\$598	S1	32.0/17.5-16.0	76	13.96	18
	1800	115/230	184TC	NONE	C174	184TCDR9627		\$584	S1	33.0/16.5	52	15.96	18

SINGLE PHASE

# General Purpose, Single Phase (NEMA Service Factor), Dripproof

Features:

- Ball bearings, mechanically locked on shaft end (excludes 5K models)
- NEMA Service Factors
- Heavy gauge steel frame and base
- Capacitor start design for high starting torque
- Capacitor start/capacitor run design for higher efficiency, as noted
- UL Recognized and CSA Certified



## C-Face Footed (Rigid Base)

HP	RPM	VOLTS	FRAME	OVER LOAD	CAT. NO.	MODEL NO.	STOCK	LIST PRICE	MULT. SYMB.	F.L. AMPS	WEIGHT	"C" DIM.	FOOT NOTES
1/4	1800	115/208-230	56C	AUTO	K234	056C17D2114		\$217	F1	5.0/2.3-2.5	18	10.30	
1/3	1800	115/208-230	56C	AUTO	K235	056C17D2115	✓	\$252	F1	6.4/3.0-3.2	18	10.30	
	1800	100-120/200/240	56C	MANUAL	E250	5KCR46JN0083Y	✓	\$303	F1	4.0-3.8/2.0-1.9	24	10.77	d,ES,1,68
	1800	100-120/200/240	56C	AUTO	E252	5KCR46JN0083X	✓	\$252	F1	4.0-3.8/2.0-1.9	23	10.77	ES,1,68
1/2	1800	100-120/200-240	56C	AUTO	E261	5KCR46MN0090X	✓	\$293	F1	5.8-5.6/2.9-2.8	27	10.77	ES,1,68
	1800	100-120/200-240	56C	MANUAL	E259	5KCR46MN0090Y		\$351	F1	5.8-5.6/2.9-2.8	27	10.77	ES,1,68
3/4	1800	100-120/200-240	56C	AUTO	E270	5KCR49PN0095X	✓	\$356	F1	9.0-8.8/4.5-4.4	31	11.37	ES,1,68
	1800	100-120/200-240	56C	MANUAL	E268	5KCR49PN0095Y	✓	\$405	F1	9.0-8.8/4.5-4.4	30	11.37	ES,1,68
1	1800	100-120/200-240	56C	MANUAL	EG277	5KCR48UN0102Y		\$576	F1	11.8-11.4/5.9-5.7	40	12.65	ES,1,68
2	3600	115/208-230	56C	MANUAL	C1269	5KC49SN2537Y	✓	\$600	F1	15.6/8.8-7.8	36	11.34	
3	3600	208-230	56C	MANUAL	C1270	5KC49ZN2539Y	✓	\$733	F1	13.0-12.0	41	12.84	

# General Purpose, Single Phase

## Totally Enclosed

Features:

- Ball bearings
- Heavy gauge steel constructions
- Economical split phase or capacitor start designs, as noted
- Service Factor, as noted
- UL Recognized and CSA Certified



## Rigid Base

HP	RPM	VOLTS	FRAME	OVER LOAD	CAT. NO.	MODEL NO.	STOCK	LIST PRICE	MULT. SYMB.	F.L. AMPS	WEIGHT	"C" DIM.	FOOT NOTES	
1/6	1800	115	48	NONE	H116	5KH32EN66	✓	\$227	F1	4.0	15	9.92	3,17	
	900	115/230	56	NONE	C248	5KC49PN3036	✓	\$591	F1	5.6/2.8	28	12.43	2,17	
1/4	1800	115	48	AUTO	HG121	5KH32FN3123X	✓	\$249	F1	5.1	15	9.92	3,17	
	1800	115	48	NONE	HG120	5KH32FN3123	✓	\$238	F1	5.1	15	9.92	3,17	
	1800	115/230	48	AUTO	C243	5KC32GN9X	✓	\$294	F1	5.4/2.7	17	10.00	2,17	
	1800	115/230	48	NONE	C242	5KC32GN9	✓	\$281	F1	5.4/2.7	17	10.00	2,17	
	1800	230	48	AUTO	H243	5KH32GN68X	✓	\$272	F1	2.7	17	9.92	3,17	
	1500	110/220	48	NONE	C462	5KC33KN19	✓	\$325	F1	5.4/2.7	18	10.17	2,17,50	
	1800	115/208-230	56	MANUAL	G314	056C17F2052	✓	\$235	F1	4.2/2.1-2.1	20	10.22	2,18	
	1800	115/230	56	AUTO	CG251	5KC32GN19X	✓	\$306	F1	5.4/2.7	17	10.38	2,17	
	1800	115/230	56	NONE	G1312	5KC32GN19	✓	\$219	F1	5.4/2.7	16	10.38	2,17	
	1200	115/230	56	NONE	G1316	5KC49MN6061	✓	\$332	F1	6.2/3.1	27	11.43	2,17	
1/3	3600	115	48	AUTO	HG124	5KH33FN85X	✓	\$260	F1	6.4	16	10.17	3,17	
	3600	115	48	NONE	HG123	5KH33FN85	✓	\$252	F1	6.4	16	10.17	3,17	
	1800	115/230	56	AUTO	G1331	5KC35MN43X	✓	\$255	F1	6.0/3.0	20	10.93	2,18	
	1800	115/208-230	56	MANUAL	G332	056C17F2049	✓	\$270	F1	6.0/3.0-3.0	20	10.47	2,18	
	1800	100-120/200-400	56	NONE	E258	5KCR46JN0089	✓	\$392	F1	4.0-3.8/2.0-1.9	25	11.83	ES,1,20,68	
	1800	115/230	56	NONE	G1330	5KC35MN43	✓	\$245	F1	6.0/3.0	17	10.93	2,18	
	1200	115/230	56	NONE	C1333	5KC49PN6062	✓	\$374	F1	8.6/4.3	31	12.43	2,18	
1/2	3600	115/208-230	56	MANUAL	G393	056C34F5307	✓	\$228	F1	8.4/4.0-4.2	22	11.82	2,14,18	
	3600	115/230	56	MANUAL	C664	5KC36LN4003Y	✓	\$228	F1	8.0/4.0	17	11.36	17,82	
	3600	115/208-230	56	NONE	K339	056C34F5327	✓	\$213	F1	8.4/4.0-4.2	23	11.82	2,14,18	
	1800	100-120/200-240	56	NONE	E267	5KCR46MN0094	✓	\$446	F1	5.8-5.6/2.9-2.8	27	11.83	ES,1,19,68	
	1800	115/230	56	AUTO	C262	5KC42GN0014X	✓	\$293	F1	8.6/4.3	21	11.00	2,18	
	1800	115/208-230	56	MANUAL	G339	056C17F2051	✓	\$311	F1	8.0/4.0-4.0	23	11.22	2,18	
	1800	115/208-230	56	MANUAL	C661	5KC46GN0569Y	✓	\$311	F1	9.0/4.5-4.5	44	11.83	18,82	
	1800	115/208-230	56	NONE	C261	5KC42GN0014	✓	\$276	F1	8.6/4.1-4.3	21	11.00	2,18	
	1800	115/230	48	NONE	CG260	5KC37RN35	✓	\$361	F1	8.8/4.4	23	11.38	2,17	
	1200	115/230	56	NONE	C264	5KC49UN6065	✓	\$474	F1	9.4/4.7	40	12.96	2,18	
	3/4	3600	115/208-230	56	MANUAL	G379	056C34F5309	✓	\$277	F1	10.6/5.3-5.3	26	12.32	2,14,18
		3600	115/208-230	56	NONE	G352	056C34F5308	✓	\$260	F1	10.6/5.3-5.3	26	12.32	2,14,18
1800		100-120/200-240	56	NONE	EG276	5KCR49PN0101	✓	\$497	F1	9.0-8.8/4.5-4.4	31	12.43	ES,7,19,68	
1800		115/230	56	AUTO	C269	5KC46PN0015X	✓	\$359	F1	11.0/5.5	31	11.83	2,17	
1800		115/208-230	56	MANUAL	G356	056C17F5308	✓	\$382	F1	11.0/5.4-5.5	29	12.32	2,14,18	
1800		115/208-230	56	NONE	C268	5KC46PN0015	✓	\$340	F1	11.0/5.4-5.5	31	11.83	2,18	
1200		115/230	56	NONE	C271	5KCR48VN6066	✓	\$566	F1	10.6/5.3	44	13.82	ES,1,17	
1200		115/208-230	143T	NONE	I707	143TBFR5376	✓	\$591	S1	11.4/5.8-5.7	42	13.87	1,14,18	

SINGLE PHASE

Continued on next page.

# General Purpose, Single Phase

## Totally Enclosed

### Rigid Base

HP	RPM	VOLTS	FRAME	OVER LOAD	CAT. NO.	MODEL NO.	STOCK	LIST PRICE	MULT. SYMB.	F.L. AMPS	WEIGHT	"C" DIM.	FOOT NOTES
1	3600	115/208-230	56	NONE	G359	056C34F5310	✓	\$298	F1	12.4/6.7-6.2	30	12.32	2,14,18
	3600	115/230	56	AUTO	C273	5KC49NN2130X	✓	\$313	F1	13.0/6.5	29	12.43	2,17
	3600	115/230	56	MANUAL	C663	5KC49NN2419Y	✓	\$313	F1	13.2/6.6	29	12.43	19,82
	3600	115/208-230	56	MANUAL	G390	056C34F5311	✓	\$313	F1	12.4/6.7-6.2	31	12.32	2,14,18
	3600	115/230	56	MANUAL	C274	5KC49NN2130Y	✓	\$313	F1	13.0/6.5	21	12.43	2,17
	1800	115/230	56	MANUAL	C660	5KC49TN0568Y	✓	\$400	F1	13.2/6.6	38	12.96	17,82
	1800	115/230	56	NONE	C275	5KC49TN0034	✓	\$383	F1	13.2/6.6	38	12.96	2,17
	1800	100-120/200-240	56	NONE	E285	5KCR49UN0108	✓	\$571	F1	11.8-11.4/5.9-5.7	40	12.96	ES,1,68
	1800	115/208-230	56	MANUAL	G373	056C17F5311	✓	\$400	F1	13.4/6.8-6.7	30	12.82	2,14,18
	1800	115/230	56	AUTO	C276	5KC49TN0034X	✓	\$392	F1	13.2/6.6	36	12.96	2,17
	1800	115/230	143T	NONE	C295	5KC49TN0033	✓	\$400	S1	13.2/6.6	38	13.33	2,17
1 1/2	3600	115/208-230	56H	MANUAL	G391	056B34F5321	✓	\$410	F1	14.2/7.7-7.1	33	12.82	1,5,14,18
	3600	115/230	56	MANUAL	C662	5KC49SN2418U	✓	\$410	F1	16.4/8.2	35	12.96	17,82
	3600	115/208-230	56H	NONE	G374	056B34F5320	✓	\$382	F1	14.2/7.7-7.1	32	12.82	1,5,14
	3600	115/208-230	143T	NONE	I220	143TBFR5301	✓	\$424	S1	14.2/7.7-7.1	33	12.87	1,14,18
	1800	115/208-230	56H	MANUAL	C659	5KCR48WN0566Y	✓	\$459	F1	14.5/7.1-7.3	40	13.82	18,82
	1800	115/208-230	56H	MANUAL	G378	056B17F5302	✓	\$459	F1	15.2/8.2-7.6	40	13.82	1,5,14,18
	1800	115/208-230	56H	NONE	G1376	5KCR48WN0273	✓	\$436	F1	14.5/7.1-7.3	44	13.82	ES,1,5,18
	1800	115/208-230	56H	AUTO	G1377	5KCR48WN0273X	✓	\$451	F1	14.5/7.1-7.3	44	13.82	ES,1,5,18
	1800	115/208-230	145T	MANUAL	I201	145TBFR5327	✓	\$507	S1	15.2/8.2-7.6	41	13.87	1,14,18
	1800	115/208-230	145T	NONE	C297	5KCR48WN0292	✓	\$450	S1	14.5/7.1-7.3	44	14.07	1,18
2	3600	115/230	56	MANUAL	G1392	5KCR49TN2139U	✓	\$464	F1	17.8/8.9	38	14.27	ES,1,18
	3600	115/208-230	56H	NONE	K350	056B34F5322		\$447	F1	18.0/10.0-9.0	38	13.32	1,5,14,18
	3600	115/208-230	145T	NONE	I221	145TBFR5303	✓	\$464	S1	18.0/10.0-9.0	39	13.37	1,14,18
	1800	115/230	145T	NONE	I700	145TBFR5334	✓	\$567	S1	18.8/9.4	50	14.87	1,14,18
	1800	115/208-230	182T	NONE	I212	182TBFR5326	✓	\$613	S1	20.0/10.8-10.0	52	15.65	F,1,18
	1800	115/208-230	182T	NONE	I206	182TBFR5301	✓	\$714	S1	24.6/13.9-12.3	57	15.81	1,17
3	3600	208-230	145T	NONE	I204	145TBFR5301		\$632	S1	13.1-11.8	50	14.87	1,14,18
	3600	208-230	145T	MANUAL	I205	145TBFR5302		\$680	S1	13.1-11.8	50	14.87	1,14,18
	1800	115/208-230	184T	NONE	I213A	184TBF7W17044	✓	\$731	S1	28.4/14.8-14.2	72	14.96	1,13,14,17
	1800	115/208-230	184T	NONE	I223A	184TBF7W7701	✓	\$912	S1	22.0-19.8	98	16.49	1,13,14,17
5	3600	208-230	184T	NONE	I214A	184TBF7W7726	✓	\$900	S1	21.5-19.5	103	17.46	1,13,14,18
	1800	208-230	213T	NONE	I216	213TBF7W7026	✓	\$971	S1	24.5-22.0	106	18.73	1,14,17
	1800	208-230	213T	NONE	I224	213TBF7W7001	✓	\$1,224	S1	36.0-32.0	112	20.23	1,14,17,F
7 1/2	3600	208-230	215T	NONE	I215	215TBF7W7026	✓	\$1,195	S1	35.0-30.0	133	21.48	1,14,17
	1800	208-230	215T	NONE	I225	215TBF7W7001	✓	\$1,491	S1	44.0-41.5	141	20.23	1,14,17,F
10	3600	208-230	215T	NONE	I217	215TBF7W7027	✓	\$1,533	S1	41.5	144	21.48	1,14,17
	1800	230	215T	NONE	I217	215TBF7W7027	✓	\$1,533	S1	41.5	144	21.48	1,14,17

SINGLE PHASE



# General Purpose, Single Phase

## Totally Enclosed

Features:

- Ball bearings mechanically locked on shaft end (excludes 5K models)
- Heavy gauge steel constructions
- Suitable for horizontal or vertical mounting
- Economical split phase or capacitor start designs, as noted
- Will accept brake kits, see Accessory section (except as noted)
- Service Factor, as noted
- UL Recognized and CSA Certified



## C-Face Footless

HP	RPM	VOLTS	FRAME	OVER LOAD	CAT. NO.	MODEL NO.	STOCK	LIST PRICE	MULT. SYMB.	F.L. AMPS	WEIGHT	"C" DIM.	FOOT NOTES
1/6	1800	115	56C	NONE	H244	5KH32EN124	✓	\$277	F1	4.0	10	10.30	3,17,24
1/4	1800	115/230	56C	NONE	G1511	5KC32GN25	✓	\$231	F1	5.4/2.7	16	10.30	2,17,24
	1200	115/230	56C	NONE	C1423	5KC49MN6063		\$356	F2	6.2/3.1	27	11.40	2,17,24
1/3	3600	115/230	56C	NONE	C1419	5KC33FN31	✓	\$205	F1	5.6/2.8	14	10.19	18,24
	1800	100-120/200-240	56C	NONE	E256	5KCR46JN0088	✓	\$417	F1	4.0-3.8/2.0-1.9	25	11.84	ES,1,20,24,68
	1800	115/230	56C	NONE	G1513	5KC35MN73	✓	\$266	F1	6.0/3.0	19	10.93	2,18,24
1/2	3600	115/208-230	56C	NONE	G514	056C34F5322		\$223	F1	8.4/4.0-4.2	23	11.82	2,18
	3600	115/230	56C	AUTO	C349	5KC36LN166X	✓	\$319	F1	7.4/3.7	19	11.36	2,18,24
	1800	100-120/200-240	56C	NONE	E265	5KCR46MN0093	✓	\$468	F1	5.8-5.6/2.9-2.8	27	11.84	ES,1,19,24,68
	1800	115/230	56C	AUTO	C446	5KC42GN0018X	✓	\$375	F1	8.6/4.3	21	11.01	2,18,24
	1800	115/230	56C	NONE	G1515	5KC42GN0018	✓	\$307	F1	8.6/4.3	21	11.01	2,18,24
3/4	1200	115/230	56C	NONE	C1404	5KC49UN6067	✓	\$644	F1	9.4/4.7	40	12.93	2,17,24
	3600	115/208-230	56C	NONE	G516	056C34F5323	✓	\$273	F1	10.6/5.3-5.3	26	12.32	2,18
	1800	100-120/200-240	56C	NONE	E274	5KCR49PN0100	✓	\$517	F1	9.0-8.8/4.5-4.4	31	12.44	ES,1,19,24,68
1	1800	115/230	56C	NONE	G1517	5KC46PN0032	✓	\$369	F1	11.0/5.5	31	11.84	2,17,24
	3600	115/208-230	56C	NONE	G518	056C34F5324	✓	\$309	F1	12.4/6.7-6.2	29	12.32	2,18
1	3600	115/230	56C	AUTO	C351	5KC49NN2133X	✓	\$407	F1	13.0/6.5	29	12.44	2,18,24
	1800	100-120/200-240	56C	NONE	EG283	5KCR49UN0107	✓	\$593	F1	11.8-11.4/5.9-5.7	40	12.97	ES,1,18,24,68
	1800	115/230	56C	NONE	G1519	5KC49TN0035	✓	\$393	F1	13.2/6.6	36	12.97	2,17,24
	1800	115/230	56C	NONE	C1424	5KC49SN2158	✓	\$392	F1	16.4/8.2	35	12.93	2,24,111
1 1/2	3600	115/230	56C	AUTO	C855	5KC49SN2156X	✓	\$498	F1	16.4/8.2	35	12.93	2,17,24
	1800	115/208-230	56C	NONE	G1531	5KCR48WN0294	✓	\$454	F1	14.5/7.1-7.3	44	13.69	ES,1,18,24
2	3600	115/208-230	56C	NONE	G533	056B34F5319	✓	\$476	F1	18.0/10.0-9.0	38	13.32	1,18
	3600	115/230	56C	AUTO	C466	5KCR49TN2155T	✓	\$610	F1	17.8/8.9	38	14.28	1,17,24

SINGLE PHASE

# General Purpose, Single Phase

## Totally Enclosed

### Features:

- Ball bearings mechanically locked on shaft end (excludes 5K models)
- Heavy gauge steel constructions
- Suitable for horizontal or vertical mounting
- Economical split phase or capacitor start designs, as noted
- Will accept brake kits, see Accessory section (except as noted)
- Service Factor, as noted
- UL Recognized and CSA Certified



## C-Face Footed (Rigid Base)

HP	RPM	VOLTS	FRAME	OVER LOAD	CAT. NO.	MODEL NO.	STOCK	LIST PRICE	MULT. SYMB.	F.L. AMPS	WEIGHT	"C" DIM.	FOOT NOTES	
1/3	1800	100-120/200-240	56C	AUTO	E257	5KCR46JN0087X	✓	\$434	F1	4.0-3.8/2.0-1.9	23	11.84	ES,1,20,24,68	
	1800	100-120/200-240	56C	MANUAL	E255	5KCR46JN0087Y	✓	\$437	F1	4.0-3.8/2.0-1.9	26	11.84	ES,1,20,24,68	
	1800	115/208-230	56C	MANUAL	F131	056C17F5358	✓	\$347	F1	6.6/3.1-3.3	23	11.82	2,18,68	
	1800	115/230	56C	NONE	C1405	5KC35MN145	✓	\$270	F1	6.0/3.0	17	10.93	2,24,18,68	
1/2	3600	115/208-230	56C	NONE	C1420	5KC36LN144	✓	\$228	F1	7.4/3.7	17	11.36	2,24,19,68	
	3600	115/230	56C	AUTO	C444	5KC36LN144X	✓	\$235	F2	7.4/3.7	25	11.36	24,68	
	1800	100-120/200-240	56C	MANUAL	E264	5KCR46MN0055Y	✓	\$484	F1	5.8-5.6/2.9-2.8	29	11.84	ES,1,19,24,68	
	1800	100-120/200-240	56C	AUTO	E266	5KCR46MN0055X	✓	\$472	F1	5.8-5.6/2.9-2.8	29	11.84	ES,1,19,24,68	
	1800	115/208-230	56C	MANUAL	F132	056C17F5912	✓	\$388	F1	8.8/4.2-4.4	25	11.82	2,18,68	
1800	115/230	56C	NONE	C375	5KC42GN0066	✓	\$311	F1	8.6/4.3	23	11.01	2,18,24,68		
	1800	100-120/200-240	56C	MANUAL	EG273	5KCR49PN0099Y	✓	\$540	F1	9.0-8.8/4.5-4.4	31	12.44	ES,1,19,24,68	
	1800	100-120/200-240	56C	AUTO	E275	5KCR49PN0099X	✓	\$530	F1	9.0-8.8/4.5-4.4	31	12.44	ES,1,19,24,68	
	1800	115/208-230	56C	MANUAL	F133	056C17F5913	✓	\$451	F1	11/5.4-5.5	29	12.32	2,18,68	
	1800	115/230	56C	NONE	C1425	5KC49PN0283	✓	\$374	F1	11.0/5.5	31	12.40	2,17,24,68	
3/4	1200	115/230	56C	NONE	C1412	5KCR49WN6078		\$605	F2	12.6/6.3	44	13.81	ES,1,24,68	
	1	3600	115/230	56C	AUTO	C445	5KC49NN2132X	✓	\$321	F2	13.0/6.5	29	12.44	24,68
	1800	100-120/200-240	56C	MANUAL	EG282	5KCR49UN0106Y	✓	\$615	F1	11.8-11.4/5.9-5.7	40	12.97	ES,1,18,24,68	
	1800	100-120/200-240	56C	AUTO	EG284	5KCR49UN0106X	✓	\$610	F1	11.8-11.4/5.9-5.7	40	12.97	ES,1,18,24,68	
	1800	115/208-230	56C	NONE	C376	5KC49TN0067	✓	\$400	F1	13.2/6.7-6.6	38	12.97	2,17,24,68	
1800	115/208-230	56C	MANUAL	F134	056C17F5914	✓	\$485	F1	13.4/6.8-6.7	31	12.82	2,18,68		
	1 1/2	3600	115/208-230	56HCZ	NONE	K631	056B34F5324		\$397	F1	14.2/7.7-7.1	34	12.82	1,18,68
	1800	115/208-230	56C	MANUAL	F135	056B17F5584	✓	\$583	F1	15.2/8.2-7.6	41	13.82	1,5,18,68	
	1800	115/208-230	145TC	NONE	C281	145TBFR5337		\$567	S1	15.2/8.2-7.6	43	13.87	1,18,68	
2	3600	115/208-230	145TC	NONE	C282	145TBFR5305		\$632	S1	16.6/9.1-8.3	42	13.37	1,18,68	
	1800	115/230	56HC	MANUAL	K319	056B17F5319	✓	\$598	F1	18.8/9.4	50	14.82	1,5,18,68	
3	3600	208-230	145TC	NONE	C284	145TBFR5306		\$678	S1	13.1-11.8	52	14.87	1,18,68	
	1800	230	184TC	MANUAL	I314A	184TBFW7041	✓	\$896	S1	12.8	86	17.61	1,13,18,68	
5	1800	230	184TC	MANUAL	I315A	184TBFW7034	✓	\$1,069	S1	21	101	18.72	1,13,17,68	

SINGLE PHASE

# General Purpose, Single Phase

## Totally Enclosed, Four in One

### Features:

- Double sealed ball bearings, mechanically locked on shaft end
- Heavy gauge steel constructions
- Bolt-on, removable rigid base
- Suitable for horizontal or vertical mounting
- Capacitor start design for high starting torque
- Capacitor start/capacitor run design for higher efficiency, as noted
- 1.15 Service Factor (except as noted)
- Will accept brake kits, see Accessory section
- Will accept drip cover kits, see Accessories section
- UL Recognized and CSA Certified



### C-Face Footed (Removable Base)

HP	RPM	VOLTS	FOUR-N ONE	FRAME	OVER LOAD	CAT. NO.	MODEL NO.	STOCK	LIST PRICE	MULT. SYMB.	F.L. AMPS	WEIGHT	"C" DIM.	FOOT NOTES
1/4	1200	115/208-230	YES	56C	NONE	G577	056C11F5302	✓	\$356	F2	6.8/3.1-3.4	24	11.82	
1/3	1800	115/208-230	YES	56C	NONE	G570	056C17F5320	✓	\$277	F2	6.6/3.1-3.3	23	11.82	68
	1200	115/208-230	YES	56C	NONE	G576	056C11F5303	✓	\$397	F2	7.8/3.6-3.9	27	12.32	
1/2	3600	115/208-230	YES	56C	NONE	D311	056C34F5301	✓	\$235	F2	8.4/4.0-4.2	22	11.82	
	1800	115/208-230	YES	56C	NONE	G571	056C17F5321	✓	\$317	F2	8.8/4.2-4.4	24	11.82	68
	1200	115/208-230	YES	56C	NONE	G578	056B11F5303	✓	\$484	F2	9.6/4.7-4.8	35	13.32	1,68
3/4	3600	115/208-230	YES	56C	NONE	D312	056C34F5302	✓	\$284	F2	10.6/5.3-5.3	27	12.32	
	1800	115/208-230	YES	56C	NONE	G572	056C17F5322	✓	\$382	F2	11.0/5.4-5.5	30	12.32	68
	1200	115/208-230	YES	56C	NONE	G579	056B11F5302	✓	\$605	F2	11.4/5.8-5.7	39	13.82	1
1	3600	115/208-230	YES	56C	NONE	D313	056C34F5303	✓	\$321	F2	11.2/5.7-5.6	30	12.32	
	1800	115/208-230	YES	56HC	NONE	G573	056C17F5323	✓	\$406	F2	13.4/6.8-6.7	31	12.82	5,68
1 1/2	3600	115/208-230	YES	56C	NONE	D314	056B34F5326	✓	\$404	F2	14.2/7.7-7.1	32	12.82	1
	1800	115/208-230	YES	56HC	NONE	G574	056B17F5305	✓	\$466	F2	15.2/8.2-7.6	40	13.82	1,5,68
2	3600	115/208-230	YES	56HC	NONE	D315	056B34F5327	✓	\$486	F2	16.6/9.1-8.3	37	13.82	1,5
	1800	115/208-230	YES	56HC	NONE	G575	056B17F5306	✓	\$584	F2	20.0/10.8-10.0	51	14.82	1,5,17
3	3600	208-230	YES	56HC	NONE	D316	056B34F5328	✓	\$650	F2	13.1-11.8	50	14.82	1,5

SINGLE PHASE

# Hazardous Duty™ Division 1 Explosion Proof Class I and II, Groups C (as noted), D, F & G Steel Frame, Single Phase

## Features:

- 1.0 Service Factor
- Automatic reset thermal protector
- Meets temperature code T3B
- Economical split phase or capacitor start designs, as noted
- Explosion proof conduit box included, shipped loose
- UL Listed File No. E12044
- CSA Certified File No. LR47504



## Resilient Base

HP	RPM	VOLTS	FRAME	GROUP C	CAT. NO.	MODEL NO.	STOCK	LIST PRICE	MULT. SYMB.	F.L. AMPS	WEIGHT	"C" DIM.	FOOT NOTES
1/4	1800	115	56	N	K032	056C17E5302		\$374	F1	4.8	26	11.88	2,N
	1200	115	56	N	K033	056C11G5303	✓	\$514	F1	5.4	31	14.46	2,37
1/3	1800	115	56	N	K037	056C17G5308		\$489	F1	6.6	29	13.96	2,37



## Rigid Base

HP	RPM	VOLTS	FRAME	GROUP C	CAT. NO.	MODEL NO.	STOCK	LIST PRICE	MULT. SYMB.	F.L. AMPS	WEIGHT	"C" DIM.	FOOT NOTES
1/12	1800	115	48	N	H454	5KH32ENB168X	✓	\$451	F1	1.90	18	9.68	3,N
1/8	1200	115	48	N	HG455	5KH36NNB166X	✓	\$511	F1	3.00	23	10.74	3,N
1/6	1800	115	48	N	HG456	5KH35LNB164X	✓	\$468	F1	3.30	22	10.31	3,N
	1200	115	56	Y	H891	5KC49LN6386X	✓	\$598	F1	3.80	26	12.47	3,N
1/4	1800	115	48	N	HG458	5KH36PNB171X	✓	\$484	F1	4.40	24	10.74	3,N
	1800	115/208-230	56	Y	G639	056C17E5314	✓	\$446	F1	4.8/2.3-2.4	26	11.97	2,N
	1800	115/230	48	N	C646	5KC36PNB169X	✓	\$548	F1	4.2/2.1	25	10.74	2,N
	1200	115	56	Y	C1801	5KC49MN6384X	✓	\$713	F1	5.6	34	13.94	2
	1200	115/208-230	56	Y	G650	056C11G5306	✓	\$597	F1	6.8/3.1-3.4	28	13.94	2
1/3	1800	115/208-230	56	Y	G651	056C17G5315	✓	\$509	F1	6.6/3.1-3.3	27	13.44	2
	1500	110/220-230	56	Y	C1803	5KC49HN0719X	✓	\$603	F1	6.8/3.1-3.4	31	13.44	2
	1200	115/208-230	56	Y	G652	056C11G5307	✓	\$641	F1	7.8/3.6-3.9	31	13.94	2
1/2	3600	115/208-230	56	Y	G653	056C34G5308	✓	\$458	F1	8.4/4.0-4.2	26	13.44	2
	1800	115/208-230	56	Y	G654	056C17G5316	✓	\$556	F1	8.8/4.2-4.4	27	13.94	2
	1500	110/220-230	56	Y	C1807	5KC49QN0716X	✓	\$618	F1	8.4/4.2-4.4	33	14.44	2,50
	1200	115/208-230	56	Y	C1809	5KC49SN6375X		\$739	F1	9.4/4.7-5.0	39	14.94	2
	1200	115/208-230	56	Y	G655	056B11G5301	✓	\$739	F1	9.6/4.7-4.8	39	14.94	1
3/4	3600	115/208-230	56	Y	G656	056C34G5309		\$516	F1	10.6/5.3-5.3	31	13.94	2
	1800	115/208-230	56	Y	C1810	5KC49QN4559X	✓	\$624	F1	11.0/5.4-5.5	38	14.44	d,2
	1800	115/208-230	56	Y	G657	056C17G5317	✓	\$624	F1	11.0/5.4-5.5	33	14.44	2
1	3600	115/208-230	56	Y	G658	056C34G5310		\$557	F1	12.4/6.7-6.2	40	14.44	2
	1800	115/208-230	56	Y	G659	056C17G5318	✓	\$652	F1	13.4/6.8-6.7	34	14.44	2

SINGLE PHASE

# Hazardous Duty™ Division 1 Explosion Proof Class I and II, Groups C, D, F & G

## Steel Frame, Single Phase

### Features:

- 1.0 Service Factor
- Automatic reset thermal protector
- Meets temperature code T3B
- 56CZ frame motors have 2-1/4 x 5/8 shaft dimensions
- Capacitor start design for high starting torque
- Explosion proof conduit box included, shipped loose
- UL Listed File No. E12044, MC228275
- CSA Certified File No. LR47504, MC236833



### C-Face Footless

HP	RPM	VOLTS	FRAME	CAT. NO.	MODEL NO.	STOCK	LIST PRICE	MULT. SYMB.	F.L. AMPS	WEIGHT	"C" DIM.	FOOT NOTES
1/4	1800	115/208-230	56C	G852	056C17E5319	✓	\$463	F1	4.8/2.3-2.4	22	11.97	
	1200	115	56CZ	C1818	5KC49MN6379X	✓	\$667	F1	5.6	34	14.30	2,37
1/3	1800	115/208-230	56C	G853	056C17G5320	✓	\$522	F1	6.6/3.1-3.3	27	13.44	
1/2	3600	115/208-230	56C	G854	056C34G5311	✓	\$470	F1	8.4/4.0-4.2	26	13.44	
	3600	115/208-230	56J	C1814	5KC49HN2509X	✓	\$690	F1	8.4/4.0-4.2	27	13.95	15
	1800	115/208-230	56C	G855	056C17G5321	✓	\$568	F1	8.8/4.2-4.4	28	13.94	
	1200	115	56CZ	C1817	5KC49SN6380X	✓	\$850	F1	8.0	47	15.30	
3/4	1800	115/208-230	56C	C1816	5KC49QN0718X	✓	\$636	F1	11.0/5.4-5.5	27	14.44	d
	1800	115/208-230	56C	G857	056C17G5322	✓	\$636	F1	11.0/5.4-5.5	33	14.44	
1	3600	115/208-230	56C	G858	056C34G5316		\$570	F1	12.4/6.2-6.7	34	14.44	
	1800	115/208-230	56C	G870	056C17G5323	✓	\$664	F1	13.4/6.8-6.7	34	14.44	



SINGLE PHASE

### C-Face Footed (Rigid Base)

HP	RPM	VOLTS	FRAME	CAT. NO.	MODEL NO.	STOCK	LIST PRICE	MULT. SYMB.	F.L. AMPS	WEIGHT	"C" DIM.	FOOT NOTES
1/3	1800	115/208-230	56C	G871	056C17G5324	✓	\$501	F1	6.6/3.1-3.3	37	13.44	
1/2	1800	115/208-230	56C	G872	056C17G5328	✓	\$573	F1	8.8/4.2-4.4	29	13.94	
3/4	3600	115/208-230	56C	G873	056C34G5314	✓	\$533	F1	10.6/5.3-5.3	30	13.94	
	1800	115/208-230	56C	G874	056C17G5326	✓	\$641	F1	11.0/5.4-5.5	34	14.44	
1	3600	115/208-230	56C	G875	056C34G5315		\$576	F1	12.4/6.7-6.2	34	14.44	
	1800	115/208-230	56C	G876	056C17G5327	✓	\$680	F1	13.4/6.8-6.7	35	14.44	

# General Purpose, Three Phase

## Dripproof, Rigid Base

Features:

- EISA compliant efficiencies, as noted
- Ball bearings (except where noted)
- NEMA Service Factors
- Will accept C-Face Kits, see Accessories Section (except as noted)
- UL Recognized and CSA Certified

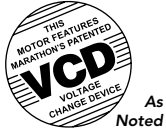

Suitable for use on VFD per guidelines on page 17.

HP	RPM	VOLTS	FRAME	OVER LOAD	CAT. NO.	MODEL NO.	STOCK	LIST PRICE	MULT. SYMB.	NOM. EFF.	F.L. AMPS	WEIGHT	"C" DIM.	FOOT NOTES	C-FACE KITS
1/4	1800	208-230/460	48	NONE	G044	048T17D2000	✓	\$195	F1	62.0	1.2-1.3/.65	13	9.34	25,68	N/A
1/3	3600	208-230/460	48	NONE	K113	5K35FN2	✓	\$187	F1	61.0	1.5-1.8/0.9	14	9.25		N/A
	1800	208-230/460	48	NONE	K527	5K35JN198	✓	\$227	F1	66.5	1.5-1.6/0.8	15	9.25		N/A
	1800	200-208	56	NONE	G046	056T17D2128		\$227	F1	67.0	1.8-1.9	15	9.97	25	N/A
	1800	208-230/460	56	NONE	G047	056T17D2095	✓	\$227	F1	67.0	1.5-1.6/0.8	15	9.97	25,68	N/A
	1200	208-230/460	56	NONE	G061	056T11D5301		\$309	F1	62.0	1.9-2.2/1.1	19	9.94	68	A435
1/2	3600	208-230/460	56	NONE	K027	056T34D5300		\$207	F1	66.0	2.1-2.2/1.1	20	10.44	68	A435
	3600	208-230/460	48	NONE	K115	5K36JN2	✓	\$207	F1	69.8	2.0-2.0/1.0	16	9.68		N/A
	1800	200-208	56	NONE	G062	056T17D2114	✓	\$255	F1	70.0	2.5-2.65	17	10.47	25	N/A
	1800	208-230/460	56	NONE	G063	056T17D2094	✓	\$262	F1	70.0	2.1-2.2/1.1	17	10.47	25,68,CF	N/A
	1800	208-230/460	56	NONE	K116	5K42HN4106	✓	\$254	F1	74.7	2.3-2.2/1.1	19	10.05	19	A534
	1800	208-230/460	56	NONE	E12D4	5KS49HN4077	✓	\$369	F1	76.9	1.8-1.8/0.9	20	10.38	ES	A534
	1800	208-230/460	56	AUTO	G905	056T17D5336	✓	\$316	F1	68.0	2.3-2.4/1.2	21	10.44	VC,68	A435
	1800	575	56	NONE	G065	056T17D2112	✓	\$255	F1	70.0	0.9	17	10.47	25	N/A
	1500	220/380	56	NONE	K318	5K42JN4163	✓	\$352	F1	66.7	3.0/1.7	21	10.05	50	A534
	1200	208-230/460	56	NONE	G067	056T11D5302	✓	\$342	F1	68.0	2.4-2.7/1.35	23	10.44	68	A435
3/4	900	208-230/460	143T	NONE	H180	143TTDR5401		\$416	E6	64.0	2.9-3.0/1.5	32	11.49	5,13	A436
	3600	208-230/460	56	NONE	G080	056T34D5301	✓	\$231	F1	74.0	3.0-3.2/1.6	21	10.44	68	A435
	1800	200-208	56	NONE	G082	056T17D2111	✓	\$285	F1	75.5	3.2-3.3	21	10.97	25	N/A
	1800	208-230/460	56	NONE	G084	056T17D2093	✓	\$305	F1	75.5	2.7-2.8/1.4	20	10.97	25,68,CF	N/A
	1800	208-230/460	56	NONE	K119	5K46KN4071	✓	\$295	F1	74.3	3.3-3.0/1.5	24	10.78	19	A534
	1800	208-230/460	56	AUTO	G908	056T17D5339	✓	\$346	F1	75.5	2.9-3.0/1.5	22	10.44	68	A435
	1800	200-230/460	56	NONE	E34D4	5KS46MN4078	✓	\$414	F1	79.2	2.5-2.4/1.2	24	10.78	ES,68	A534
	1800	575	56	NONE	G086	056T17D2110	✓	\$285	F1	75.5	1.1	20	10.97	25	A435
	1200	208-230/460	56	NONE	G088	056T11D5303		\$353	F1	74.0	3.1-3.2/1.6	25	10.94	68	A435
	1200	208-230/460	143T	NONE	H150	143TTDR5376	✓	\$321	E6	74.0	3.1-3.2/1.6	29	10.99	5,68	A436
	900	208-230/460	145T	NONE	H181	145TTDR5401	✓	\$472	E6	72.0	4.0-4.0/2.0	42	12.99	68	A436
	1	3600	208-230/460	56	NONE	K000	056T34D5302	✓	\$263	F1	74.0	3.7-3.7/1.85	23	10.44	
1800		200	143T	NONE	<b>E901</b>	143TTDR5348	✓	\$297	E2	82.5	3.6	40	12.49	5,13	A436
1800		200-208	56	NONE	K003	056T17D2113	✓	\$293	F1	76.5	3.9-4.1	23	11.47	25	N/A
1800		200-208	143T	AUTO	<b>U416</b>	143TTDR4061		\$423	E2	82.5	3.6-3.43	39	12.49	5,13	A436
1800		208-230/460	56	NONE	K004	056T17D2092	✓	\$310	F1	76.5	3.4-3.4/1.7	23	11.47	25,68,CF	N/A
1800		208-230/460	56	NONE	K122	5K46MN4072	✓	\$300	F1	79.2	3.6-3.8/1.9	27	10.78	19	A534
1800		208-230/460	56	NONE	K2069	5KE49PN4594	✓	\$417	F1	82.5	3.2-3.1/1.55	30	11.38		A534
1800		208-230/460	56	AUTO	G921	056T17D5342	✓	\$353	F1	77.0	3.5-3.6/1.8	24	10.94	VC,68	A436
1800		208-230/460	56HZ	AUTO	K063	056T17D3301	✓	\$375	F1	77.0	3.5-3.6/1.8	27	10.99	Z,5,68	A436
1800		208-230/460	56HZ	AUTO	K067	056T17D3305		\$389	F1	77.0	3.5-3.6/1.8	27	10.99	VC,Z,5,68	A436

Catalog numbers (Cat No.) highlighted in bold blue have efficiency levels that meet EISA requirements

Continued on next page.

# General Purpose, Three Phase

## Dripproof, Rigid Base

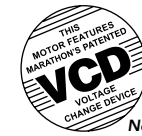

As Noted

HP	RPM	VOLTS	FRAME	OVER LOAD	CAT. NO.	MODEL NO.	STOCK	LIST PRICE	MULT. SYMB.	NOM. EFF.	F.L. AMPS	WEIGHT	"C" DIM.	FOOT NOTES	C-FAKE KITS	
1	1800	208-230/460	143T	AUTO	<b>U417A</b>	143TTDR6052		\$495	E2	85.5	3.2-3.0/1.5	45	12.99	5,13,68	A436	
	1800	208-230/460	143T	AUTO	U418	143TTDR4051	✓	\$440	E2	82.5	3.3-3.1/1.55	38	12.49	d,VC,5,13,68	A436	
	1800	208-230/460	143T	AUTO	<b>U418A</b>	143TTDR6051	✓	\$515	E2	85.5	3.2-3.0/1.5	45	12.99	VC,5,13,68	A436	
	1800	575	56	NONE	K049	056T17D2130	✓	\$293	F1	76.5	1.4	24	11.47	25	N/A	
	1800	575	56HZ	AUTO	K081	056T17D15528		\$375	F1	77.0	1.45	27	10.99	Z,5	A436	
	1800	575	143T	AUTO	<b>U922</b>	143TTDR4055		\$423	E2	82.5	1.1	39	12.49	5,13	A436	
	1800	575	143T	AUTO	<b>U922A</b>	143TTDR16036		\$495	E2	85.5	1.2	45	12.99	5,13	A436	
	1800	575	143T	NONE	<b>E912</b>	143TTDR5351		\$297	E2	82.5	1.1	39	12.49	5,13	A436	
	1200	200	145T	NONE	<b>E785</b>	145TTDR4078		\$389	E2	80.0	4.1	47	13.49	5,13	A436	
	1200	208-230/460	56H	NONE	K007	056T11D5304		\$382	F1	75.5	4.1-4.2/2.1	29	11.44	5,68	A435	
	1200	575	145T	NONE	E934	145TTDR4080		\$389	E2	80.0	1.4	47	13.49	5,13	A436	
	900	230/460	182T	NONE	<b>H182A</b>	182TTDW7101		\$511	E6	75.8	4.0/2.0	69	12.19	13	A666	
	1 1/2	3600	200	143T	NONE	E917	14TTDR4005		\$330	E2	82.5	5.5	31	10.90	5,13	A436
		3600	208-230/460	56	NONE	K009	056T34D5303	✓	\$324	F1	80.0	4.9-5.0/2.5	24	10.44	68	A435
		3600	208-230/460	143T	NONE	E783	143TTDR5313	✓	\$330	E2	82.5	4.2-4.2/21	31	10.99	d,5,13,68	A436
3600		208-230/460	143T	NONE	<b>E783A</b>	143TTDR6313	✓	\$452	E2	86.5	4-3.8/1.9	101	12.49	5,13,68	A436	
3600		575	143T	NONE	<b>E798</b>	143TTDR4006		\$330	E2	82.5	1.9	28	10.99	5,13	A436	
1800		200	145T	NONE	<b>E902</b>	145TTDR5632	✓	\$324	E2	84.0	5.0	39	12.49	5,13	A436	
1800		200-208	145T	AUTO	<b>U419</b>	145TTDR4128		\$450	E2	84.0	5.0-4.9	39	12.49	5,13	A436	
1800		208-230/460	56H	NONE	K022	056T17D5309	✓	\$325	F1	80.0	4.8-4.8/2.4	28	10.94	5,68	A436	
1800		208-230/460	56H	AUTO	G923	056T17D5344	✓	\$386	F1	80.0	4.8-4.8/2.4	27	10.94	VC,5,68	A436	
1800		208-230/460	56HZ	AUTO	K064	056T17D3302	✓	\$398	F1	80.0	4.8-4.8/2.4	30	10.99	Z,5,68	A436	
1800		208-230/460	56HZ	AUTO	K068	056T17D3306	✓	\$408	F1	80.0	4.8-4.8/2.4	33	10.99	VC,Z,5,68	A436	
1800		208-230/460	145T	AUTO	<b>U420A</b>	145TTDR6126	✓	\$526	E2	86.5	4.4-4.4/2.2	48	12.49	5,13,68	A436	
1800		208-230/460	145T	AUTO	<b>U421A</b>	145TTDR6127		\$546	E2	86.5	4.4-4.4/2.2	48	12.49	VC,5,13,68	A436	
1800		575	56H	NONE	K061	056T17D5369	✓	\$325	F1	80.0	1.9	27	10.94	5	A436	
1800		575	145T	AUTO	<b>U923</b>	145TTDR4130		\$450	E2	84.0	1.8	39	12.49	5,13	A436	
1800	575	145T	AUTO	<b>U923A</b>	145TTDR16054		\$553	E2	86.5	1.8	47	12.99	5,13	A436		
1500	220/380	145T	NONE	K408	5K49SN8050	✓	\$456	E2	81.7	4.5/2.6	35	13.59	50	A536		
1200	200	182T	NONE	<b>E1799</b>	182TTDW4083	✓	\$428	E2	84.0	7.2	75	12.69	13	A666		
900	230/460	184T	NONE	<b>H183A</b>	184TTDW7101		\$620	E6	77.0	5.6/2.8	62	13.19	13	A666		
2	3600	200	145T	NONE	<b>U905</b>	145TTDR4103		\$389	E2	84.0	6.2	29	10.99	5,13	A436	
	3600	208-230/460	56H	NONE	K025	056T34D5304	✓	\$382	F1	80.0	6.4-6.2/3.1	24	10.44	5,68	A435	
	3600	575	145T	NONE	<b>U906</b>	145TTDR4005		\$389	E2	84.0	2.2	31	10.99	5,13	A436	
	1800	200-208	145T	NONE	<b>E903</b>	145TTDR5633	✓	\$357	E2	84.0	6.7-6.6	43	12.99	5,13	A436	
	1800	200-208	145T	AUTO	<b>U422</b>	145TTDR4134	✓	\$485	E2	84.0	6.7-6.6	43	12.99	5,13	A436	
	1800	208-230/460	56H	NONE	K041	056T17D5310	✓	\$357	F1	81.5	6.2-6.2/3.1	33	11.94	5,68	A436	
	1800	208-230/460	56HZ	AUTO	K065	056T17D3303	✓	\$427	F1	81.5	6.2-6.2/3.1	35	11.99	Z,5,68	A436	
	1800	208-230/460	56HZ	AUTO	K069	056T17D3307	✓	\$440	F1	81.5	6.2-6.2/3.1	34	11.99	VC,Z,5,68	A436	
	1800	208-230/460	145T	AUTO	<b>U423A</b>	145TTDR6132	✓	\$568	E2	86.5	6.2-6.0/3.0	56	12.49	5,13,68	A436	
	1800	208-230/460	145T	AUTO	<b>U424A</b>	145TTDR6133	✓	\$588	E2	86.5	6.2-6.0/3.0	56	12.99	VC,5,13,68	A436	
	1800	575	56H	NONE	K062	056T17D5370	✓	\$357	F1	81.5	2.5	33	11.94	5	A436	
	1800	575	145T	NONE	<b>E914</b>	145TTDR5665	✓	\$357	E2	84.0	2.3	43	12.99	5,13	A436	
	1800	575	145T	NONE	<b>E914A</b>	145TTDR16062	✓	\$547	E2	86.5	2.4	37	13.62		A600	
	1800	575	145T	AUTO	<b>U924</b>	145TTDR4136		\$485	E2	84.0	2.3	42	12.99	5,13	A436	
	1800	575	145T	AUTO	<b>U924A</b>	145TTDR16059		\$568	E2	86.5	2.4	56	13.49	5,13	A436	
1200	200	184T	NONE	<b>E918</b>	184TTDR4178		\$549	E2	85.5	7.15	89	15.22	13,25	A666		
900	230/460	213T	NONE	<b>H184A</b>	213TTDW14102		\$877	E2	85.5	8.0/4.0	142	17.30		A606		
3	3600	200	145T	NONE	<b>E919</b>	145TTDR4003		\$408	E2	84.0	10.0	33	11.49	5,13	A436	
	3600	208-230/460	56H	NONE	K048	056T34D5340		\$424	F1	84.0	8.8-8.2/4.1	32	11.44	5	A436	
	3600	575	145T	NONE	<b>E932</b>	145TTDR4105		\$408	E2	84.0	3.5	33	11.49	5,13	A436	

GENERAL PURPOSE THREE PHASE

Catalog numbers (Cat No.) highlighted in bold blue have efficiency levels that meet EISA requirements

Continued on next page.

# General Purpose, Three Phase

## Dripproof, Rigid Base



HP	RPM	VOLTS	FRAME	OVER LOAD	CAT. NO.	MODEL NO.	STOCK	LIST PRICE	MULT. SYMB.	NOM. EFF.	F.L. AMPS	WEIGHT	"C" DIM.	FOOT NOTES	C-FACE KITS	
3	1800	200	182T	NONE	<b>E1904</b>	182TTDW4027	✓	\$418	E2	86.5	10.1	60	12.69	13,25,CF	A666	
	1800	200-208	182T	AUTO	<b>U1425</b>	182TTDW4074	✓	\$571	E2	86.5	9.6-9.7	62	12.69	13	A666	
	1800	200-208	182T	AUTO	<b>U425B</b>	182TTDW16048		\$668	E2	89.5	9.0-8.9	71	13.19	13	A666	
	1800	208-230/460	56HZ	NONE	H803	056T17D5398	✓	\$389	F1	84.0	9.2-8.6/4.3	47	13.49	Z,13,68	A436	
	1800	208-230/460	56HZ	AUTO	K066	056T17D3304	✓	\$436	F1	84.0	9.2-8.6/4.3	47	13.49	Z,5,68	A436	
	1800	208-230/460	56HZ	AUTO	K080	056T17D3308	✓	\$450	F1	84.0	9.2-8.6/4.3	47	13.99	VC,Z,5,68	A436	
	1800	208-230/460	182T	AUTO	<b>U426B</b>	182TTDW16049	✓	\$668	E2	89.5	8.6-8.0/4.0	72	13.19	13	A666	
	1800	575	182T	NONE	<b>E1915</b>	182TTDW4030		\$418	E2	86.5	3.5	60	12.69	13	A666	
	1800	575	182T	AUTO	<b>U925</b>	182TTDR4075		\$571	E2	86.5	3.5	78	14.22	d, 25	N/A	
	1800	575	182T	AUTO	<b>U925A</b>	182TTDW16082		\$668	E2	89.5	3.2	87	14.19	13,25	A666	
	1200	200	213T	NONE	<b>U907</b>	213TTDW4078	✓	\$743	E2	86.5	9.65	121	17.30		A606	
	900	230/460	215T	NONE	<b>H185A</b>	215TTDW14110		\$1,096	E2	86.5	10.0/5.0	225	18.55		A606	
5	3600	200	182T	NONE	<b>E933</b>	182TTDR4104		\$468	E2	86.5	13.8	74	13.72	25	N/A	
	3600	575	182T	NONE	<b>U908</b>	182TTDR4106		\$468	E2	85.5	4.8	83	13.72	25	N/A	
	1800	200	184T	NONE	<b>E1905</b>	184TTDW4027	✓	\$454	E2	87.5	15.6	79	13.19	13	A666	
	1800	200-208	184T	AUTO	<b>U427</b>	184TTDR4153	✓	\$647	E2	87.5	15.0/14.4	76	15.22	d,25	N/A	
	1800	200-208	184T	AUTO	<b>U427A</b>	184TTDW4153	✓	\$647	E2	87.5	15.0/14.7	77	13.19	13	A666	
	1800	208-230/460	184T	AUTO	<b>U428B</b>	184TTDW16038	✓	\$756	E2	89.5	13.6-12.6/6.3	75	14.19	13,68	A666	
	1800	575	184T	NONE	<b>E1916</b>	184TTDW4030	✓	\$454	E2	87.5	5.3	79	13.19	13	A666	
	1800	575	184T	AUTO	<b>U917</b>	184TTDW16041		\$647	E2	89.5	5.1	82	14.19	13	A666	
	1200	200	215T	NONE	<b>E935</b>	215TTDW4078	✓	\$865	E2	87.5	16.1	145	18.55	13	A606	
	900	230/460	254T	NONE	<b>H186A</b>	254TTDX14104	✓	\$1,515	E2	87.5	17.6/8.8	133	20.57	22.32	A612	
	7 1/2	3600	200	184T	NONE	<b>E937A</b>	184TTDW4003		\$606	E2	87.5	20.3	68	14.19	13,25	A666
		3600	575	184T	NONE	<b>E938</b>	184TTDR4105		\$606	E2	87.5	7.0	78	14.72		A666
1800		200	213T	NONE	<b>E906</b>	213TTDBA4028	✓	\$632	E2	88.5	24.9	114	17.30	13,25	A606	
1800		200-208	213T	AUTO	<b>U429</b>	213TTDW4070		\$921	E2	88.5	22.1-21.2	118	18.04	13	A606	
1800		208-230/460	213T	AUTO	<b>U430A</b>	213TTDW16060	✓	\$1,078	E2	91.0	21.0-19.2/9.6	135	19.29	13,68	A606	
1800		575	213T	NONE	<b>E758</b>	213TTDW4030		\$632	E2	88.5	7.7	113	17.30	13	A606	
1800		575	213T	AUTO	<b>U926</b>	213TTDW4071		\$921	E2	88.5	7.7	118	17.30	13	A606	
1800		575	213T	AUTO	<b>U926A</b>	213TTDW16061		\$1,078	E2	91.0	7.7	125	19.29	13	A606	
900		230/460	256T	NONE	H187	256TTDX7101	✓	\$1,790	E6	84.0	26.0/13.0	148	22.32	d	A612	
900		230/460	256T	NONE	<b>H187A</b>	256TTDN14102	✓	\$1,925	E2	88.5	22.0/11.0	162	24.37		N/A	
10		3600	200	213T	NONE	<b>E939</b>	213TTDW4003		\$787	E2	88.5	26.9	120	17.30	13	A606
		1800	200	215T	NONE	<b>E907</b>	215TTDW4028	✓	\$811	E2	89.5	28.8	125	17.30	13	A606
	1800	575	215T	NONE	<b>E759</b>	215TTDW4030	✓	\$811	E2	89.5	10.0	123	17.30	d,13	A606	
	1200	230/460	256T	NONE	<b>E734</b>	256TTDX4076	✓	\$1,261	E2	90.2	28.0/14.0	178	22.32		A612	
	900	230/460	284T	NONE	<b>H188A</b>	284TTDN14102		\$2,284	E2	89.5	38.5/19.2	328	24.94		A610	
15	3600	200	215T	NONE	<b>E788</b>	215TTDW4003	✓	\$1,210	E2	90.2	39.1	120	18.55	13	A606	
	1800	200	254T	NONE	<b>E908</b>	254TTDX4028	✓	\$1,215	E2	91.0	44.2	208	22.32		A612	
	1800	575	254T	NONE	<b>E760</b>	254TTDX4030	✓	\$1,215	E2	91.0	15.4	184	22.32		A612	
	900	230/460	286T	NONE	<b>H189A</b>	286TTDN14101		\$3,003	E2	89.5	42.0/21.0	361	26.81		A610	
20	3600	200	254T	NONE	<b>U900</b>	254TTDX4018		\$1,426	E2	91.0	53.1	214	20.57		A612	
	1800	200	256T	NONE	<b>E909</b>	256TTDX4027	✓	\$1,484	E2	91.0	60.0	227	22.32		A612	
	1800	575	256T	NONE	<b>E761</b>	256TTDX4032		\$1,484	E2	91.0	20.8	198	22.32		A612	
25	3600	200	256T	NONE	<b>E786</b>	256TTDX4013	✓	\$1,740	E2	91.0	66.5	200	22.32		A612	
	1800	200	284T	NONE	<b>E910</b>	284TTP4029	✓	\$1,723	E2	91.7	70.0	350	23.49		A610	
	1800	575	284T	NONE	<b>E762</b>	284TTP4035		\$1,723	E2	91.7	24.4	351	23.49		A610	
	900	230/460	326T	NONE	<b>H191A</b>	326TTDR14105		\$4,283	E2	90.2	73.0/36.5	565	28.50		A613	

Catalog numbers (Cat No.) highlighted in bold blue have efficiency levels that meet EISA requirements

Blue shaded areas are Cast Iron Frames

Continued on next page.



# General Purpose, Three Phase

## Dripproof, Rigid Base

HP	RPM	VOLTS	FRAME	OVER LOAD	CAT. NO.	MODEL NO.	STOCK	LIST PRICE	MULT. SYMB.	NOM. EFF.	F.L. AMPS	WEIGHT	"C" DIM.	FOOT NOTES	C-FACE KITS
30	3600	200	284TS	NONE	<b>U901</b>	284TSTDP4004		\$2,076	E2	91.0	83.0	320	22.06		A610
	1800	200	286T	NONE	<b>E911</b>	286TTDP4027	√	\$2,004	E2	92.4	83.0	350	24.99		A610
	1800	575	286T	NONE	<b>E763</b>	286TTDP4034		\$2,004	E2	92.4	28.8	285	24.99		A610
40	3600	200	286TS	NONE	<b>U902</b>	286TSTDP4017		\$2,658	E2	91.7	108	460	23.56		A610
	1800	200	324T	NONE	<b>E787</b>	324TTDP4030		\$2,493	E2	93.0	112	542	26.00		A613
	1800	575	324T	NONE	<b>E764</b>	324TTDP4028		\$2,493	E2	93.0	39.0	474	26.00		A613
50	3600	200	324TS	NONE	<b>U909</b>	324TSTDP4006		\$3,158	E2	92.4	135	385	24.50		A613
	1800	200	326T	NONE	<b>E790</b>	326TTDP4046		\$2,906	E2	93.0	142	499	27.50		A613
	1800	575	326T	NONE	<b>E765</b>	326TTDP4048		\$2,906	E2	93.0	49.0	496	27.50		A613
60	3600	200	326TS	NONE	<b>U910</b>	326TSTDP4003		\$3,591	E2	93.0	155	398	26.00		A613
	1800	575	364T	NONE	<b>E766</b>	364TTDS4040		\$3,562	E2	93.6	57.5	699	28.62	d	A216
75	1800	575	365T	NONE	<b>E767</b>	365TTDS4041		\$4,338	E2	94.1	71.0	730	29.62		A216
100	1800	575	404T	NONE	<b>U903</b>	404TTDS4042		\$5,532	E2	94.1	94.5	1004	32.50		A222
125	1800	575	405T	NONE	<b>U904</b>	405TTDS4049		\$6,624	E2	94.5	118	1083	34.00		A222
150	1800	575	444T	NONE	<b>U911</b>	444TTDS4069		\$9,566	E2	95.0	141	1321	37.75		A228
200	1800	575	445T	NONE	<b>U912</b>	445TTDS4070		\$12,085	E2	95.0	186	1447	39.75		A228
250	3600	460	445TS	NONE	<b>E757</b>	445TSTDS4001	√	\$17,697	E2	94.5	279	1406	36.00	PW,68	A231
	1800	460	445T	NONE	<b>E745</b>	445TTDS4037		\$14,420	E2	95.4	287	1561	39.75	PW,RB	A228
	1200	460	447T	NONE	<b>H822A</b>	447TTDN14087		\$15,156	E2	95.4	308	2345	43.25	F,RB,YD,25	N/A
300	3600	460	447TS	NONE	<b>H178</b>	447TSTDN7001	√	\$16,918	E6	95.0	332	1940	39.50	F,YD,68	A293
	1800	460	447TS	NONE	<b>H812</b>	447TSTDN7026	√	\$15,976	E6	95.4	345	1994	39.50	F,YD,68	A293
	1200	460	449T	TSTAT	<b>H820</b>	449TTDN7086		\$16,360	E6	95.4	357	2632	48.25	F,YD,17,25	N/A
350	3600	460	447TS	NONE	<b>H193</b>	447TSTDN7003	√	\$19,379	E6	95.0	385	2013	39.50	F,YD,68	A293
	1800	460	447TS	NONE	<b>H813</b>	447TSTDN7027	√	\$17,363	E6	95.4	400	2064	39.50	F,YD,68	A293
	1200	460	449T	TSTAT	<b>H821A</b>	449TTDN14078		\$23,628	E2	95.4	420	2145	48.25	F,YD,17,25	N/A
400	3600	460	447TS	NONE	<b>H817</b>	447TSTDN7005	√	\$22,049	E6	95.4	440	2150	39.50	F,YD,68	A293
	1800	460	447TS	NONE	<b>H814</b>	447TSTDN7028	√	\$20,152	E6	95.4	450	2220	39.50	F,YD	A293
450	3600	460	449TS	TSTAT	<b>H818</b>	449TSTDN7001	√	\$23,550	E6	95.8	502	2544	44.50	F,YD,68	A293
	1800	460	449TS	TSTAT	<b>H815A</b>	449TSTDN14033		\$23,169	E6	95.8	505	2695	44.50	F,YD	A293
500	3600	460	449TS	TSTAT	<b>H819A</b>	449TSTDN14005	√	\$28,591	E6	95.8	546	2737	44.50	F,YD	A293
	1800	460	449TS	TSTAT	<b>H816</b>	449TSTDN7027		\$23,599	E6	95.8	560	2695	44.50	F,YD	A293

Catalog numbers (Cat No.) highlighted in bold blue have efficiency levels that meet EISA requirements

Blue shaded areas are Cast Iron Frames

# General Purpose, Three Phase Dripproof

Features:

- Ball bearings, mechanically locked on shaft end
- NEMA Service Factors
- UL Recognized and CSA Certified



## C-Face Footless

Suitable for use on VFD per guidelines on page 17.

HP	RPM	VOLTS	FRAME	CAT. NO.	MODEL NO.	STOCK	LIST PRICE	MULT. SYMB.	NOM. EFF.	F.L. AMPS	WEIGHT	"C" DIM.	FOOT NOTES
1/4	1800	208-230/460	56C	K247	5K49DN4132	✓	\$205	F1	67.4	1.1-1.2/0.6	17	9.52	17,68
1/3	3600	208-230/460	56C	KG215	5K35FN55	✓	\$177	F1	61.0	1.5-1.8/0.9	14	9.90	68,115
	1800	208-230/460	56C	K248	5K49FN4138	✓	\$237	F1	69.2	1.5-1.6/0.8	20	9.52	68
1/2	3600	208-230/460	56C	K216	5K36JN57	✓	\$201	F1	69.8	2.0-2.0/1.0	16	10.31	68,114
	1800	208-230/460	56C	K249	5K42HN4127	✓	\$267	F1	74.7	2.3-2.2/1.1	19	9.90	68
	1800	575	56C	G242	056T17D2115	✓	\$267	F1	68.0	0.9	17	10.30	
	1200	208-230/460	56C	K1299	5K46MN6018	✓	\$353	F1	72.0	2.4-2.7/1.4	23	10.44	68
3/4	3600	208-230/460	56C	G205	056T34D5327		\$242	F1	74.0	3.0-3.2/1.6	20	10.44	68
	3600	208-230/460	56C	K218	5K37MN37	✓	\$242	F1	74.0	2.6-2.6/1.3	17	10.70	48,68,113
	1800	208-230/460	56C	K250	5K46KN4125	✓	\$298	F1	74.3	2.7-2.8/1.4	24	10.80	
	1800	575	56C	G243	056T17D2116	✓	\$298	F1	75.5	1.1	19	10.80	d
	1200	208-230/460	56C	K1300	5K49PN6019	✓	\$365	F1	76.1	2.9-2.8/1.4	26	11.38	
1	3600	208-230/460	56C	K220	5K38PN47	✓	\$275	F1	74.0	3.3-3.2/1.6	36	11.30	48,68,112
	1800	208-230/460	56C	K251	5K46MN4126	✓	\$304	F1	79.2	3.6-3.8/1.9	24	10.73	
	1800	208-230/460	143TC	K634	5K46MN8423	✓	\$357	E6	79.2	3.6-3.8/1.9	27	12.42	d
	1800	208-230/460	143TC	<b>K634A</b>	143TTDR14049	✓	\$384	E2	82.5	3.3-3.1/1.55	34	12.49	
	1800	575	56C	G244	056T17D2127		\$304	F1	77.0	1.4	23	11.30	
	1200	208-230/460	145TC	<b>C150A</b>	145TTDR14088	✓	\$475	E2	80.0	3.8-3.6/1.8	43	13.49	68
1 1/2	3600	208-230/460	56C	K222	5K46KN2173	✓	\$335	F1	80.0	5.0-4.8/2.4	24	10.73	48,68,111
	3600	208-230/460	143TC	<b>K2018</b>	5KE49PN8418	✓	\$417	E6	82.5	4.4-4.0/2.0	35	11.50	
	1800	208-230/460	56C	K521	5K49PN4120	✓	\$336	F1	79.8	5.8-5.6/2.8	31	11.33	
	1800	208-230/460	145TC	K622	5K49RN8424	✓	\$383	E6	82.1	5.2/2.6	33	11.95	d
	1800	208-230/460	145TC	<b>K622A</b>	145TTDR14049	✓	\$412	E2	84.0	4.6-4.4/2.2	41	12.49	
	1200	208-230/460	145TC	<b>C162A</b>	145TTDR14087		\$497	E2	84.0	5.45-5.4/2.7	51	12.49	68
2	3600	208-230/460	145TC	<b>C102A</b>	145TTDR14007	✓	\$475	E2	84.0	5.4/2.7	34	10.99	68
	3600	208-230/460	56C	K224	5K49NN2180	✓	\$392	F1	80.0	6.0-6.0/3.0	27	11.33	48,68,110
	1800	208-230/460	56C	K644	5K49ZN4611	✓	\$369	F1	83.8	6.6-6.4/3.2	49	13.81	
	1800	208-230/460	145TC	<b>C122A</b>	145TTDR4341	✓	\$444	E2	84.0	6.2-5.8/2.9	42	11.99	68
	1800	208-230/460	145TC	<b>K2043</b>	5KE49UN8428	✓	\$483	E6	84.0	6.4-6.0/3.0	40	12.62	24,68
	1200	230/460	184TC	<b>C152A</b>	184TTDW14078		\$572	E2	85.5	6.8/3.4	28	13.28	13,68
3	3600	208-230/460	56C	G289	056T34D5339		\$440	F1	84.0	8.9-8.4/4.2	31	11.44	68
	3600	208-230/460	56C	K226	5K48TN2182	✓	\$440	F1	84.0	8.9-8.4/4.2	38	12.61	18,48,68
	3600	208-230/460	145TC	<b>C103</b>	145TTDR5312	✓	\$485	E6	84.0	8.9-8.4/4.2	32	11.49	68
	1800	208-230/460	182TC	C123	182TTDR8067	✓	\$494	E6	81.5	9.2-9.0/4.5	67	14.28	d,68
	1800	208-230/460	182TC	<b>C123B</b>	182TTDW4028	✓	\$531	E2	86.5	9-8.8/4.4	63	12.78	13,68
5	3600	208-230/460	182TC	<b>C104B</b>	182TTDW14008	✓	\$662	E2	85.5	14.0-12.4/6.2	65	13.73	13,68
	1800	208-230/460	184TC	<b>C124B</b>	184TTDW14027	✓	\$580	E2	87.5	13.2/6.6	87	13.28	13,68
7 1/2	3600	208-230/460	184TC	<b>C105B</b>	184TTDW14017	✓	\$758	E2	87.5	20.0-17.6/8.8	74	14.28	13,68
	1800	208-230/460	213TC	<b>C125A</b>	213TTDW14057		\$767	E2	88.5	21.0-19.0/9.5	148	18.03	68
	1200	208-230/460	254TC	<b>C155A</b>	254TTDX14089		\$1,233	E2	88.5	23.0-21.4/10.7	217	20.92	68
10	3600	208-230/460	213TC	<b>C106A</b>	213TTDW14014	✓	\$934	E2	88.5	26.0-23.4/11.7	105	18.03	68
	1800	208-230/460	215TC	<b>C126A</b>	215TTDW14071		\$930	E2	89.5	28.0-25.0/12.5	124	18.03	68
	1200	230/460	256TC	<b>C156A</b>	256TTDX14087		\$1,398	E2	90.2	28.0/14.0	201	22.67	68

GENERAL PURPOSE THREE PHASE

# General Purpose, Three Phase

## Dripproof

Applications: General purpose use on gear reducers, pumps, machine tools, and other direct coupled equipment installed in environments that are relatively clean and dry. For use outdoors an enclosure or drip cover may be required (see Accessories section).

Features:

- Ball bearings, mechanically locked on shaft end (excludes 5K models)
- NEMA Service Factors
- UL Recognized and CSA Certified



### C-Face Footed (Rigid Base)

Suitable for use on VFD per guidelines on page 17.

HP	RPM	VOLTS	FRAME	CAT. NO.	MODEL NO.	STOCK	CT SPEED RANGE*	LIST PRICE	MULT. SYMB.	NOM. EFF.	F.L. AMPS	WEIGHT	"C" DIM.	FOOT NOTES
1/3	1800	208-230/460	56C	K1305	5K42FN4033	✓	----	\$259	F1	69.2	1.5-1.6/0.8	17	9.95	
1/2	3600	208-230/460	56C	K1306	5K49FN2045	✓	----	\$245	F1	65.5	2.2-2.5/1.3	19	10.38	114
	1800	208-230/460	56C	K1307	5K42HN4032	✓	----	\$289	F1	74.7	2.3-2.2/1.1	19	9.95	68
3/4	1800	208-230/460	56C	K1308	5K46KN4031	✓	----	\$320	F1	74.3	3.3-3.0/1.5	24	10.78	
1	1800	208-230/460	143TC	<b>K2021</b>	5KE49PN8391		----	\$347	E2	82.5	3.2-3.1/1.55	34	11.50	
	1800	208-230/460	56HC	K635	5K46MN4623	✓	----	\$325	F1	79.2	3.6-3.8/1.9	27	10.78	
1 1/2	3600	208-230/460	56C	K690	5K46HN2546	✓	----	\$356	F1	80.0	5.2-5.0/2.5	22	10.44	
	1800	208-230/460	145TC	<b>K2022</b>	5KE49TN8401	✓	----	\$356	E2	84.0	4.5-4.4/2.2	39	12.03	
2	1800	208-230/460	56HC	K646	5K49RN4617	✓	----	\$357	F1	82.1	5.2/2.6	33	11.91	
	3600	208-230/460	56C	K1311	5K49NN2046	✓	----	\$414	F1	80.5	6.6-6.0/3.0	27	11.38	
2	1800	208-230/460	145TC	<b>K2023</b>	5KE49UN8407	✓	----	\$401	E2	84.0	6.4-6.0/3.0	42	13.34	
	1800	208-230/460	56HC	K648	5K49ZN4616	✓	----	\$390	F1	83.6	6.2-5.8/2.9	49	13.86	
3	3600	230/460	145TC	<b>U401A</b>	145TTDR16308	✓	2:1	\$572	E2	86.5	7.2/3.6	45	12.69	68
	1800	230/460	182TC	<b>U410A</b>	182TTDW16059	✓	2:1	\$624	E2	89.5	8.0/4.0	76	14.19	13,68
5	3600	208-230/460	182TC	<b>U402C</b>	182TTDW16010	✓	2:1	\$788	E2	86.5	13.4-12.4/6.2	65	13.20	13,68
	1800	230/460	184TC	<b>U403A</b>	184TTDW16043		2:1	\$771	E2	89.5	13.6-12/6.3	89	14.20	13,68
7 1/2	3600	208-230/460	184TC	<b>U404B</b>	184TTDW16001		2:1	\$1,061	E2	88.5	17.8/8.9	85	14.20	13,68
	1800	230/460	213TC	<b>U405A</b>	213TTDW16063	✓	2:1	\$1,048	E2	91.0	16.2/8.1	168	18.03	68
10	3600	230/460	213TC	<b>U432A</b>	213TTDW16010		2:1	\$1,083	E2	89.5	23.4/11.7	127	18.03	YD,68
	1800	208-230/460	215TC	<b>U433A</b>	215TTDW16061		2:1	\$1,246	E2	91.7	27.0-25.0/12.5	185	19.28	YD,68
15	3600	230/460	215TC	<b>U435</b>	215TTDW4315		2:1	\$1,349	E2	90.2	34.0/17.0	128	19.28	YD,13,68
	1800	208-230/460	254TC	<b>U436A</b>	254TTDN16056	✓	2:1	\$1,641	E2	93.0	37.0/18.5	221	23.31	YD,68
20	3600	230/460	254TC	<b>U437</b>	254TTDX4315		2:1	\$1,615	E2	91.0	46.0/23.1	200	20.89	YD,68
	1800	208-230/460	256TC	<b>U438A</b>	256TTDN16049		2:1	\$1,955	E2	93.0	59.0-55.0/27.5	235	24.81	YD,68
25	3600	230/460	256TC	U439	256TTDX4315		2:1	\$1,928	E2	91.0	58.0/29.0	185	22.64	d,YD,68
	3600	230/460	256TC	<b>U439A</b>	256TTDN16009		2:1	\$2,255	E2	91.7	58.0/29.0	243	24.81	YD,68
30	1800	230/460	284TSC	<b>U440A</b>	286TSTDN16034		2:1	\$2,365	E2	93.6	61.0/30.5	356	14.50	YD,68
	3600	230/460	284TSC	<b>U441A</b>	286TSTDN16005	✓	2:1	\$2,780	E2	91.7	67.5/34	234	25.44	YD,68
40	1800	230/460	286TSC	<b>U442A</b>	286TSTDN16033		2:1	\$2,694	E2	94.1	73.0/36.5	376	25.44	YD,68
	3600	230/460	286TSC	<b>U443A</b>	286TSTDN16004		2:1	\$3,458	E2	92.4	90.0/45.0	354	25.44	YD,68
50	1800	230/460	324TSC	<b>U444A</b>	324TSTD16032		----	\$3,418	E2	94.1	94.0/47.0	465	24.50	YD,68
	3600	230/460	324TSC	U445	324TSTD16016	✓	----	\$3,589	E2	92.4	117/58.5	420	24.50	d,YD,68
60	3600	230/460	324TSC	<b>U445A</b>	324TSTD16002	✓	----	\$4,196	E2	93.0	112/56.0	443	24.50	YD,68
	1800	230/460	326TSC	<b>U446A</b>	326TSTD16035		----	\$3,901	E2	94.5	121/60.5	453	27.00	YD,68
75	3600	230/460	326TSC	<b>U447A</b>	326TSTD16005	✓	----	\$4,703	E2	93.6	135/67.5	366	26.00	YD,68
	1800	230/460	364TSC	<b>U448A</b>	365TSTDS16044		----	\$4,894	E2	95.0	139/69.5	748	26.50	YD,68
100	3600	230/460	364TSC	<b>U449A</b>	365TSTDS16008		----	\$6,832	E2	93.6	170/85.0	732	27.50	YD,68
	1800	230/460	365TSC	<b>U450A</b>	365TSTDS6074		----	\$5,801	E2	95.0	174/87.0	803	27.50	YD,68
125	3600	230/460	404TSC	<b>U451A</b>	365TSTDS16005		----	\$8,081	E2	93.6	230/115	799	27.50	YD,68
	1800	230/460	404TSC	<b>U452A</b>	404TSTDS6327		----	\$7,556	E2	95.4	226/113	1056	29.50	YD,68
150	3600	460	404TSC	<b>U453A</b>	404TSTDS16006	✓	----	\$9,719	E2	94.1	138	991	29.50	YD,68
	1800	460	405TSC	<b>U454A</b>	405TSTDS16039		----	\$8,833	E2	95.4	141	1132	29.50	YD,68
150	3600	460	405TSC	<b>U455A</b>	405TSTDS16005		----	\$12,214	E2	94.1	165	1034	31.00	YD,68
	1800	460	444TSC	<b>U456A</b>	444TSTDS16034		----	\$12,379	E2	95.8	170	1376	34.00	YD,13,68

Catalog numbers (Cat No.) highlighted in bold blue have efficiency levels that meet EISA requirements

Blue shaded areas are Cast Iron Frames

\* Requires nameplate modification

GENERAL PURPOSE THREE PHASE

# General Purpose, Three Phase Dripproof, NEMA Premium® XRI® Efficiency

## Applications:

General purpose use on compressors, pumps, conveyors, blowers, and other machinery in environments that are relatively clean and dry. Substantial energy savings can be realized when using these high efficiency motors. Guaranteed efficiencies offer an eXtra Return on your Investment when using these premium efficiency motors on high cycle or long run time applications.



## Features:

### Meets or exceeds NEMA Premium® efficiencies

#### NEMA Premium® models are in compliance with EISA2007

- Motors are suitable for 10:1 VT on all frame sizes and 10:1 CT up to 365T frame (Except where noted)
- 1.15 Service Factor
- TSTATS available from Mod Central
- Class F Insulation
- Nameplated 60/50 hertz
- UL Recognized, CSA Certified and CE Marked
- Three year warranty



## Rigid Base

Suitable for use on VFD per guidelines on page 17.

HP	RPM	VOLTS	FRAME	CAT. NO.	MODEL NO.	STOCK	LIST PRICE	MULT. SYMB.	NOM. EFF.	F.L. AMPS	WEIGHT	"C" DIM.	FOOT NOTES	C FACE KIT	
1	3600	208-230/460	56H	<b>U244</b>	056T17D6001	✓	\$406	E2	80.0	2.8-3.4/1.4	24	10.18	13	A435	
	1800	208-230/460	143T	<b>U758</b>	143TTDR6027	✓	\$463	E2	85.5	3.2/1.6	30	12.12		A600	
	1800	208-230/460	143T	<b>U758-P</b>	143TTDR16052	✓	\$488	E2	85.5	3.5-3.2/1.6	30	12.50	P	A436	
	1800	575	143T	<b>E912A</b>	143TTDR16037	✓	\$463	E2	85.5	1.3	30	12.12		A600	
	1200	208-230/460	145T	<b>U265</b>	145TTDR6076	✓	\$539	E2	82.5	3.8-4.4/2.2	41	12.62		A600	
	1200	575	145T	<b>E934A</b>	145TTDR16077	✓	\$539	E2	82.5	1.8	41	12.62		A600	
1 1/2	3600	208-230/460	143T	<b>U245</b>	143TTDR6028	✓	\$452	E2	84.0	4.4-4.0/2.0	36	12.28		A600	
	3600	575	143T	<b>E798A</b>	143TTDR16005	✓	\$452	E2	84.0	1.6	36	12.28		A600	
	1800	208-230/460	145T	<b>U759</b>	145TTDR6028	✓	\$483	E2	86.5	4.8-5.6/2.4	35	12.62		A600	
	1800	208-230/460	145T	<b>U759-P</b>	145TTDR16348	✓	\$510	E2	86.5	4.8-5.6/2.4	35	13.00	P	A436	
	1800	575	145T	<b>E913A</b>	145TTDR16061	✓	\$483	E2	86.5	1.8	35	12.62		A600	
	1200	208-230/460	182T	<b>U1266</b>	182TTDW6076	✓	\$634	E2	86.5	6.2/3.1	68	13.19	13	A666	
	1200	575	182T	<b>U914</b>	182TTDW16009	✓	\$634	E2	86.5	2.5	68	13.19	13	A666	
	2	3600	208-230/460	145T	<b>U246</b>	145TTDR6039	✓	\$533	E2	85.5	5.2-4.8/2.4	43	13.12		A436
3600		575	145T	<b>U906A</b>	145TTDR16008	✓	\$533	E2	85.5	2.1	43	13.12		A436	
1800		208-230/460	145T	<b>U760</b>	145TTDR6029	✓	\$547	E2	86.5	5.8/2.9	37	13.62		A600	
1800		208-230/460	145T	<b>U760-P</b>	145TTDR16349	✓	\$577	E2	86.5	6.4-5.8/2.9	37	14.00	P	A436	
1800		575	145T	<b>E914A</b>	145TTDR16062	✓	\$547	E2	86.5	2.4	37	13.62		A600	
1200		208-230/460	184T	<b>U1267</b>	184TTDW6076	✓	\$646	E2	87.5	7.2/3.6	90	15.19	13	A666	
1200		575	184T	<b>U915</b>	184TTDW16076	✓	\$646	E2	87.5	2.9	90	15.19	13	A666	
3		3600	208-230/460	145T	<b>U247</b>	145TTDR6002	✓	\$539	E2	86.5	8.0-7.2/3.6	45	13.12		A600
		3600	575	145T	<b>E932A</b>	145TTDR16010	✓	\$539	E2	86.5	2.9	45	13.12		A600
		1800	208-230/460	182T	<b>E1930</b>	182TTDW6030	✓	\$561	E2	89.5	8.4-8.0/4.0	76	14.19	13	A666
	1800	208-230/460	182T	<b>E1930-P</b>	182TTDW16063	✓	\$592	E2	89.5	8.4-8.0/4.0	76	14.57	13,P	A666	
	1800	575	182T	<b>E915B</b>	182TTDW16029	✓	\$561	E2	89.5	3.4	76	14.19	13	A666	
	1200	208-230/460	213T	<b>U268</b>	213TTDC6076	✓	\$886	E2	88.5	10.2-10.0/5.0	156	16.38	d	A602	
1200	575	213T	<b>U279</b>	213TTDC6079	✓	\$886	E2	88.5	4.0	156	16.38	d	A602		

Catalog numbers (Cat No.) highlighted in bold blue have efficiency levels that meet EISA requirements

Blue shaded areas are Cast Iron Frames

Continued on next page.

# General Purpose, Three Phase Dripproof, NEMA Premium® XRI® Efficiency Rigid Base

HP	RPM	VOLTS	FRAME	CAT. NO.	MODEL NO.	STOCK	LIST PRICE	MULT. SYMB.	NOM. EFF.	F.L. AMPS	WEIGHT	"C" DIM.	FOOT NOTES	C FACE KIT	
5	3600	208-230/460	182T	<b>U1248</b>	182TTDW6001	✓	\$591	E2	86.5	13.0-12.0/6.0	86	15.19	13	A666	
	3600	575	182T	<b>U908A</b>	182TTDW16008	✓	\$591	E2	86.5	5.6	86	15.19	13	A666	
	1800	208-230/460	184T	<b>E1931</b>	184TTDW6031	✓	\$631	E2	89.5	13.6-12.8/6.4	89	15.19	13	A666	
	1800	208-230/460	184T	<b>E1931-P</b>	184TTDW16061	✓	\$665	E2	89.5	13.6-12.8/6.4	89	15.57	13,P	A666	
	1800	575	184T	<b>E916B</b>	184TTDW16040	✓	\$631	E2	89.5	5.3	89	15.19	13	A666	
	1200	208-230/460	215T	<b>U269</b>	215TTDC6076	✓	\$1,031	E2	90.2	15.8-15.0/7.5	185	16.38	d	A602	
	1200	575	215T	<b>U280</b>	215TTDC6079	✓	\$1,031	E2	90.2	6.0	185	16.38	d	A602	
7 1/2	3600	208-230/460	184T	<b>U249A</b>	184TTDW6001	✓	\$855	E2	88.5	19.6-17.6/8.8	106	16.19	13	A666	
	3600	575	184T	<b>E938A</b>	184TTDW16027	✓	\$855	E2	88.5	7.0	106	16.19	13	A666	
	1800	208-230/460	213T	<b>U763</b>	213TTDC6026	✓	\$817	E2	91.0	20.6-19.8/9.9	160	16.38		A602	
	1800	208-230/460	213T	<b>U430A-P</b>	213TTDW16073	✓	\$862	E2	91.0	21.0-19.2/9.6	135	19.67	13,P	A606	
	1800	575	213T	<b>U281</b>	213TTDC6029	✓	\$817	E2	91.0	7.8	160	16.38	d	A602	
	1200	208-230/460	254T	<b>U254</b>	254TTDC6076	✓	\$1,289	E2	92.4	23.4-22.4/11.2	281	20.94	d,YD	A622	
	1200	230/460	254T	<b>E733A</b>	254TTDX16082	✓	\$1,289	E2	92.4	21.0/10.5	240	22.40		N/A	
	1200	575	254T	<b>U282</b>	254TTDC6079	✓	\$1,289	E2	92.4	8.1	281	20.94	d,YD	A622	
	10	3600	208-230/460	213T	<b>U764</b>	213TTDC6001	✓	\$932	E2	91.0	25.0-23.6/11.8	150	16.38	d	A602
		3600	575	213T	<b>U283</b>	213TTDC6003	✓	\$932	E2	91.0	9.4	150	16.38	d	A602
		1800	208-230/460	215T	<b>U431A-P</b>	215TTDW16073	✓	\$1,017	E2	91.7	29.0-26.2/13.1	175	22.15	13,P	A606
		1800	208-230/460	215T	<b>U765</b>	215TTDC6026	✓	\$964	E2	91.7	28.5-25.6/12.8	220	17.87		A602
1800		575	215T	<b>U284</b>	215TTDC6029	✓	\$964	E2	91.7	10.0	220	17.87	d,A	A602	
1200		230/460	256T	<b>E734A</b>	256TTDX16078	✓	\$1,607	E2	91.7	27.4/13.7	300	23.90		N/A	
1200		208-230/460	256T	<b>U255</b>	256TTDC6076	✓	\$1,607	E2	91.7	31.0-29.6/14.8	305	22.60	d,YD	A622	
1200		575	256T	<b>U285</b>	256TTDC6079	✓	\$1,607	E2	91.7	10.8	305	22.60	d,YD	A622	
15		3600	208-230/460	215T	<b>U766</b>	215TTDC6001	✓	\$1,366	E2	91.0	38.0-34.6/17.3	184	17.87	d,99	A602
		3600	575	215T	<b>U286</b>	215TTDC6003	✓	\$1,366	E2	91.0	13.8	184	17.87	d,99	A602
	1800	208-230/460	254T	<b>U767</b>	254TTDC6026	✓	\$1,335	E2	93.0	40.5-37.0/18.5	310	20.94	A,YD	A622	
	1800	230/460	254T	<b>E722A</b>	254TTDX16042	✓	\$1,335	E2	93.0	38.0/18.9	230	22.10		N/A	
	1800	230/460	254T	<b>E722A-P</b>	254TTDX16043	✓	\$1,408	E2	93.0	38.0/18.9	230	22.50	P	N/A	
	1800	575	254T	<b>U287</b>	254TTDC6029	✓	\$1,335	E2	93.0	15.0	310	20.94	d,A,YD	A622	
	1200	230/460	284T	<b>E1002</b>	284TTDR16077	✓	\$2,116	E2	91.7	43.0/21.5	340	24.30		N/A	
	1200	208-230/460	284T	<b>U256</b>	284TTDC6076	✓	\$2,116	E2	92.4	42.0-39.5/19.7	414	23.54	YD	A626	
	1200	575	284T	<b>U288</b>	284TTDC6079	✓	\$2,116	E2	92.4	16.0	414	23.54	d,YD	A626	
	20	3600	230/460	254T	<b>E708A</b>	254TTDX16010	✓	\$1,574	E2	91.0	48.0/24.0	243	22.10		N/A
3600		208-230/460	254T	<b>U768</b>	254TTDC6001	✓	\$1,574	E2	93.0	50.0-46.0/23.0	300	20.94	d,YD	A622	
3600		575	254T	<b>U289</b>	254TTDC6003	✓	\$1,574	E2	93.0	18.4	300	20.94	d,YD	A622	
1800		230/460	256T	<b>E723A</b>	256TTDX16032	✓	\$1,653	E2	93.6	49.0/24.5	259	22.10		N/A	
1800		230/460	256T	<b>E723A-P</b>	256TTDX16033	✓	\$1,744	E2	93.6	49.0/24.5	259	22.50	P	N/A	
1800		208-230/460	256T	<b>U769</b>	256TTDC6026	✓	\$1,653	E2	93.0	55.0-51.0/25.5	360	22.60	YD	A622	
1800		575	256T	<b>U290</b>	256TTDC6029	✓	\$1,653	E2	93.0	19.2	360	22.60	d,YD	A626	
1200		208-230/460	286T	<b>U257</b>	286TTDC6076	✓	\$2,577	E2	92.4	58.0-55.0/27.5	457	25.00	d,YD	A626	
25		3600	230/460	256T	<b>E709A</b>	256TTDX16006	✓	\$2,004	E2	91.7	57.0/28.5	261	22.10		N/A
		3600	208-230/460	256T	<b>U770</b>	256TTDC6001	✓	\$2,004	E2	93.0	64.0-57.4/28.7	315	22.60	d,YD	A622
	3600	575	256T	<b>U291</b>	256TTDC6003	✓	\$2,004	E2	93.0	23.0	315	22.60	d,YD	A626	
	1800	230/460	284T	<b>E1006</b>	284TTDR16047	✓	\$1,950	E2	93.6	70.2/35.1	292	24.30		N/A	
	1800	230/460	284T	<b>E1006-P</b>	284TTDR16048	✓	\$2,057	E2	93.6	70.2/35.1	292	24.68	P	N/A	
	1800	208-230/460	284T	<b>U771</b>	284TTDC6026	✓	\$1,950	E2	93.6	66.0-59.6/29.8	424	23.54	YD	A626	
	1800	208-230/460	284TS	<b>E793A</b>	284TSTDN16031	✓	\$1,950	E2	93.6	64.0/32.0	424	23.57		A287	
	1800	575	284T	<b>E762A</b>	284TTDC6029	✓	\$1,950	E2	93.6	23.8	424	23.54	d,YD	A627	
	1200	208-230/460	324T	<b>U798</b>	324TTDC6076	✓	\$3,070	E2	93.0	72.0-67.0/33.5	695	26.02	d,YD	A627	
	30	3600	230/460	284TS	<b>E1008</b>	284TSTDN16003	✓	\$2,479	E2	91.7	69.0/34.5	270	22.90		N/A
3600		208-230/460	284TS	<b>U772</b>	284TSTDC6001	✓	\$2,479	E2	94.1	85.0-67.0/33.5	396	22.17	d,YD	A626	
3600		575	284TS	<b>U292</b>	284TSTDC6003	✓	\$2,479	E2	94.1	28.1	396	22.17	d,YD	A626	
1800		230/460	284T	<b>E1009</b>	286TTDR16037	✓	\$2,250	E2	94.1	73.2/36.6	303	25.80		N/A	
1800		230/460	284T	<b>E1009-P</b>	286TTDR16038	✓	\$2,374	E2	94.1	73.2/36.6	202	26.18	P	N/A	
1800		208-230/460	286T	<b>U773</b>	286TTDC6026	✓	\$2,250	E2	94.1	78.0-71.0/35.5	483	25.00	d,YD	A626	
1800		208-230/460	286TS	<b>E794A</b>	286TSTDN16036	✓	\$2,250	E2	94.1	78.0-71.0/35.5	483	25.44		A287	
1800		575	286T	<b>E763A</b>	286TTDC6029	✓	\$2,250	E2	94.1	28.6	483	25.00	d,YD	A627	
1200		208-230/460	326T	<b>U799</b>	326TTDC6076	✓	\$3,599	E2	93.6	86.3-78.0/39.0	760	27.52	d,YD	A627	

GENERAL PURPOSE THREE PHASE

Catalog numbers (Cat No.) highlighted in bold blue have efficiency levels that meet EISA requirements

Blue shaded areas are Cast Iron Frames

Continued on next page.

# General Purpose, Three Phase Dripproof, NEMA Premium® XRI® Efficiency

## Rigid Base

HP	RPM	VOLTS	FRAME	CAT. NO.	MODEL NO.	STOCK	LIST PRICE	MULT. SYMB.	NOM. EFF.	F.L. AMPS	WEIGHT	"C" DIM.	FOOT NOTES	C FACE KIT	
40	3600	230/460	286TS	<b>E1010</b>	286TSTDR16002	✓	\$2,984	E2	92.4	103.5/51.8	369	22.90		N/A	
	3600	208-230/460	286TS	<b>U774</b>	286TSTDC6001	✓	\$2,984	E2	93.6	100-91.2/45.6	452	23.62	d,A,YD,99	A626	
	3600	575	286TS	<b>U293</b>	286TSTDC6003	✓	\$2,984	E2	93.6	36.5	452	23.62	d,A,YD,99	A626	
	1800	230/460	284T	<b>U775-P</b>	324TTDR16050	✓	\$2,984	E2	94.1	96.0/48.0	540	28.00	P	N/A	
	1800	208-230/460	324T	<b>U775</b>	324TTDC6026	✓	\$2,828	E2	94.1	130-118/59.0	581	26.02	d,YD	A627	
	1800	208-230/460	326TS	<b>E789A</b>	326TSTDP16032	✓	\$2,828	E2	94.1	100/50.0	581	26.00		A613	
	1800	575	324T	<b>E764A</b>	324TTDC6029	✓	\$2,828	E2	94.1	38.0	581	26.02	d,YD	A627	
	1200	208-230/460	364T	<b>U1927</b>	364TTDCA6086	✓	\$4,619	E2	94.1	107-100/50.0	875	31.60	YD	A626	
50	3600	208-230/460	324TS	<b>U776</b>	324TSTDC6001	✓	\$3,638	E2	94.1	123-112/56.0	548	24.53	d,YD	A627	
	3600	575	324TS	<b>U294</b>	324TSTDC6003	✓	\$3,638	E2	94.1	44.8	548	24.53	d,YD	A627	
	1800	208-230/460	326TS	<b>E791A</b>	326TSTDR16034	✓	\$3,369	E2	94.5	121/60.5	453	27.00		N/A	
	1800	230/460	326T	<b>E791A-P</b>	326TTDR16063	✓	\$3,554	E2	94.5	121/60.5	453	27.38	P	N/A	
60	1800	208-230/460	326T	<b>U777</b>	326TTDC6026	✓	\$3,369	E2	94.5	129-118/59.0	710	27.52	YD	A627	
	1800	575	326T	<b>E765A</b>	326TTDC6029	✓	\$3,369	E2	94.5	48.0	710	27.52	d,YD	A627	
	1200	208-230/460	365T	<b>U1928</b>	365TTDCA6086	✓	\$5,317	E2	94.1	134-125/62.5	930	32.80	d,YD	A629	
	3600	208-230/460	326TS	<b>U778</b>	326TSTDC6001	✓	\$4,352	E2	94.1	148-136/68.0	590	26.02	d,YD	A627	
	1800	208-230/460	364T	<b>U1779</b>	364TTDCA6060	✓	\$4,007	E2	95.4	151.5-140/70.0	1005	31.60	YD	A629	
	1800	208-230/460	365TS	<b>E768C</b>	365TSTDS16042	✓	\$4,007	E2	95.4	153-139/69.5	1005	27.50		A219	
	1800	575	365T	<b>E766A</b>	365TTDS16067	✓	\$4,007	E2	95.4	55.5	1005	29.62	YD	A216	
	1200	230/460	404T	<b>U270</b>	404TTDS6086	✓	\$6,400	E2	95.0	146/73.0	975	32.50		A222	
75	3600	208-230/460	364TS	<b>U1782</b>	364TSTDCA6001	✓	\$5,750	E2	93.6	190-170/85.0	937	31.54	d,YD	A629	
	1800	208-230/460	365T	<b>U1783</b>	365TTDCA6060	✓	\$4,799	E2	95.4	189-174/87.0	1030	32.72	d,YD	A629	
	1800	208-230/460	365TS	<b>E782C</b>	365TSTDS16041	✓	\$4,799	E2	95.4	194-174/87.0	1030	27.50		A219	
	1800	575	365T	<b>E767A</b>	365TTDS16064	✓	\$4,799	E2	95.0	69.5	1030	29.62	YD	A216	
	1200	230/460	405T	<b>U271</b>	405TTDS16081	✓	\$7,866	E2	95.0	180/90.0	1100	34.00		A222	
100	3600	208-230/460	365TS	<b>U1784</b>	365TSTDCA6001	✓	\$7,037	E2	94.5	251-224/112	1016	32.72	d,YD	A629	
	1800	230/460	404T	<b>E922</b>	404TTDS6060	✓	\$6,256	E2	95.4	226/113	1025	32.50	YD	A222	
	1800	230/460	404TS	<b>E780A</b>	404TSTDS16036	✓	\$6,256	E2	95.4	226/113	1025	29.50		A225	
	1800	575	404T	<b>U903A</b>	404TTDS16055	✓	\$6,256	E2	95.4	90.5	1025	32.50	YD	A222	
	1200	230/460	444T	<b>U272</b>	444TTDS16077	✓	\$9,764	E2	95.4	234/117	1300	37.75		A228	
125	3600	460	404TS	<b>U250</b>	404TSTDS6001	✓	\$8,418	E2	95.0	140	973	29.50	YD	A225	
	1800	460	405T	<b>E923</b>	405TTDS6060	✓	\$7,919	E2	95.4	141	1150	34.00	YD	A222	
	1800	460	405TS	<b>E781A</b>	405TSTDS16038	✓	\$7,919	E2	95.4	141	1150	31.00	PW	A225	
	1800	575	405T	<b>U904A</b>	405TTDS16060	✓	\$7,919	E2	95.4	113	1150	34.00	YD	A222	
	1200	460	445T	<b>U273</b>	445TTDS16076	✓	\$12,814	E2	95.0	145	1500	39.75	YD	A228	
	150	3600	460	405TS	<b>U251</b>	405TSTDS6007	✓	\$10,599	E2	95.0	165	1075	31.00	YD	A225
150	1800	460	444T	<b>E924</b>	444TTDS6060	✓	\$10,631	E2	95.8	170	1275	37.75	YD	A228	
	1800	460	444TS	<b>E792A</b>	444TSTDS16038	✓	\$10,631	E2	95.8	170	1275	34.00	PW	A231	
	1800	575	444T	<b>U911A</b>	444TTDS16043	✓	\$10,631	E2	95.8	170	1275	37.75	YD	A228	
	1200	460	447T	<b>U274</b>	447TTDN16077	✓	\$13,175	E2	95.4	185	2050	43.25		N/A	
	200	3600	460	444TS	<b>U252</b>	444TSTDS16003	✓	\$15,323	E2	95.8	216	1277	34.00	YD	A231
200	1800	460	445T	<b>E925</b>	445TTDS6060	✓	\$13,339	E2	95.8	225	1500	39.75	YD	A228	
	1800	460	445TS	<b>U400A</b>	445TSTDS16038	✓	\$13,339	E2	95.8	225	1500	36.00	PW	A231	
	1800	575	445T	<b>U912A</b>	445TTDS16041	✓	\$13,339	E2	95.8	180	1500	39.75	YD	A228	
	1200	460	449T	<b>U275</b>	449TTDN16076	✓	\$15,730	E2	95.4	245	2200	43.25	YD	N/A	
	250	3600	460	447TS	<b>U785</b>	447TSTDN16004	✓	\$17,846	E2	95.8	274	1438	39.50	YD	A293
250	1800	460	447T	<b>U786</b>	447TTDN16046	✓	\$16,478	E2	96.2	292	1438	43.25	YD	N/A	
	300	3600	460	447TS	<b>U788</b>	447TSTDN16007	✓	\$20,819	E2	95.4	330	1745	39.50	YD	A293
	1800	460	447T	<b>U789</b>	447TTDN16041	✓	\$18,660	E2	96.2	340	1745	43.25	YD	N/A	
300	1200	460	449T	<b>U790</b>	449TTDN16077	✓	\$24,663	E2	95.8	365	2112	48.25	YD	N/A	
	350	3600	460	447TS	<b>U791</b>	447TSTDN16008	✓	\$22,900	E2	95.4	385	1745	39.50	YD	A293
400	3600	460	449TS	<b>U793</b>	449TSTDN16003	✓	\$26,471	E2	95.8	450	2112	44.50	YD	A293	
450	3600	460	449TS	<b>U795</b>	449TSTDN16004	✓	\$33,459	E2	95.8	495	2112	44.50	YD	A293	
500	3600	460	449TS	<b>U797</b>	449TSTDN16005	✓	\$37,275	E2	95.8	545	2147	44.50	YD	A293	

Catalog numbers (Cat No.) highlighted in bold blue have efficiency levels that meet EISA requirements

Blue shaded areas are Cast Iron Frames

# General Purpose, Three Phase Globetrotter® NEMA Premium® Efficiency Dripproof

Features:

- ⊕ Meets or exceeds NEMA Premium® efficiencies  
NEMA Premium® models are in compliance with EISA2007
- 182T-215T models steel frame, 254T-449T models cast iron frame
- Inverter Duty 10:1 Variable Torque and 2:1 Constant Torque, 1.0 SF
- 1.15 Service Factor
- Class F Insulation
- Standard assembly F1, reversible to F2 assembly
- UL Recognized, CSA Certified, CE Mark
- Three year warranty



## Rigid Base

HP	RPM	VOLTS	FRAME	CAT. NO.	MODEL NO.	STOCK	LIST PRICE	MULT. SYMB.	NOM. EFF.	F.L. AMPS	WEIGHT	"C" DIM.	FOOT NOTES	C FACE KIT
1 1/2	1200	230/460	182T	<b>GT0005</b>	182TTDB6076	✓	\$623	E1	86.5	4.8-4.4/2.2	75	13.72		A160
2	1200	208-230/460	184T	<b>GT0008</b>	184TTDB6076	✓	\$634	E1	87.5	6.4-5.8/2.9	99	14.72		A160
3	1800	208-230/460	182T	<b>GT0010</b>	182TTDB6026	✓	\$551	E1	89.5	8.4-7.8/3.9	76	13.72		A160
	1200	208-230/460	213T	<b>GT0011</b>	213TTDB6076	✓	\$870	E1	88.5	9.2-8.8/4.4	156	17.52		A161
5	3600	208-230/460	182T	<b>GT0012</b>	182TTDB6001	✓	\$581	E1	86.5	13.2-11.8/5.9	126	13.72		A160
	1800	208-230/460	184T	<b>GT0013</b>	184TTDB6026	✓	\$620	E1	89.5	13.6-12.4/6.2	86	14.72		A160
	1200	208-230/460	215T	<b>GT0014</b>	215TTDB6076	✓	\$1,012	E1	89.5	15.2-14.0/7.0	281	17.52		A161
7 1/2	3600	208-230/460	184T	<b>GT0015</b>	184TTDB6001	✓	\$714	E1	88.5	19.0-17.0/8.5	143	14.72	A	A160
	1800	208-230/460	213T	<b>GT0016</b>	213TTDB6026	✓	\$802	E1	91.0	20.7-19.0/9.5	160	17.52		A161
	1200	208-230/460	254T	<b>GT0017</b>	254TTDCA6076	✓	\$1,266	E1	90.2	22.0-21.0/10.5	281	22.64		A163
10	3600	208-230/460	213T	<b>GT0018</b>	213TTDB6001	✓	\$916	E1	89.5	25.5-23.0/11.5	150	17.52		A161
	1800	208-230/460	215T	<b>GT0019</b>	215TTDB6026	✓	\$947	E1	91.7	26.9-25.0/12.5	220	17.52		A161
	1200	208-230/460	256T	<b>GT0020</b>	256TTDCA6076	✓	\$1,578	E1	91.7	29.6-27.6/13.8	305	24.22		A163
15	3600	208-230/460	215T	<b>GT0021</b>	215TTDB6001	✓	\$1,342	E1	90.2	38.0-34.0/17.0	184	17.52		A161
	1800	208-230/460	254T	<b>GT0022</b>	254TTDCA6026	✓	\$1,311	E1	93.0	40.0-38.0/19.0	310	22.64		A163
	1200	208-230/460	284T	<b>GT0023</b>	284TTDCA6076	✓	\$2,078	E1	91.7	42.5-40.0/20.0	414	25.71	YD	A165
20	3600	208-230/460	254T	<b>GT0024</b>	254TTDCA6001	✓	\$1,546	E1	91.0	51.0-46.0/23.0	300	22.64	YD	A162
	1800	208-230/460	256T	<b>GT0025</b>	256TTDCA6026	✓	\$1,623	E1	93.0	53.0-49.0/24.5	360	24.22	YD	A163
	1200	208-230/460	286T	<b>GT0026</b>	286TTDCA6076	✓	\$2,532	E1	92.4	58.0-54.0/27.0	457	27.09	YD	A165
25	3600	208-230/460	256T	<b>GT0027</b>	256TTDCA6001	✓	\$1,969	E1	91.7	64.0-57.0/28.5	315	24.22	YD	A162
	1800	208-230/460	284T	<b>GT0028</b>	284TTDCA6026	✓	\$1,915	E1	93.6	66.0-62.0/31.0	424	25.71	YD	A165
	1200	208-230/460	324T	<b>GT0029</b>	324TTDCA6076	✓	\$3,016	E1	93.0	72.0-68.0/34.0	695	28.55	YD	A167
30	3600	208-230/460	284TS	<b>GT0030</b>	284TSTDCA6001	✓	\$2,435	E1	91.7	76.0-68.0/34.0	396	24.41	YD	A164
	1800	208-230/460	286T	<b>GT0031</b>	286TTDCA6026	✓	\$2,210	E1	94.1	81.0-74.0/37.0	483	27.09	YD	A165
	1200	208-230/460	326T	<b>GT0032</b>	326TTDCA6076	✓	\$3,535	E1	93.6	83.5-78.5/39.0	760	29.73	YD	A167
40	3600	208-230/460	286TS	<b>GT0033</b>	286TSTDCA6001	✓	\$2,931	E1	92.4	100-90.0/45.0	452	25.79	YD	A164
	1800	208-230/460	324T	<b>GT0034</b>	324TTDCA6026	✓	\$2,777	E1	94.5	105-95.0/47.5	581	28.55	YD	A167
	1200	208-230/460	364T	<b>GT0035</b>	364TTDCB6086	✓	\$4,537	E1	94.1	106-99.0/49.5	875	31.69	YD	A169
50	3600	208-230/460	324TS	<b>GT0036</b>	324TSTDCA6001	✓	\$3,573	E1	93.0	124-93.0/46.5	548	27.05	YD	A166
	1800	208-230/460	326T	<b>GT0037</b>	326TTDCA6026	✓	\$3,310	E1	94.5	131-118/59.0	710	29.73	YD	A167
	1200	208-230/460	365T	<b>GT0038</b>	365TTDCB6086	✓	\$5,223	E1	94.1	132-122/61.0	930	33.27	YD	A169
60	3600	208-230/460	326TS	<b>GT0039</b>	326TSTDCA6001	✓	\$4,275	E1	93.6	148-134/67.0	590	28.23	YD	A166
	1800	208-230/460	364T	<b>GT0040</b>	364TTDCB6060	✓	\$3,935	E1	95.0	153-139/69.5	1005	31.69	YD	A169
	1200	230/460	404T	<b>GT0041</b>	404TTDCB6086	✓	\$6,286	E1	94.5	144/72.0	975	37.20	YD	A415

Catalog numbers (Cat No.) highlighted in bold blue have efficiency levels that meet EISA requirements

Blue shaded areas are Cast Iron Frames

Continued on next page.

# General Purpose, Three Phase Globetrotter® NEMA Premium® Efficiency

Dripproof

## Rigid Base

HP	RPM	VOLTS	FRAME	CAT. NO.	MODEL NO.	STOCK	LIST PRICE	MULT. SYMB.	NOM. EFF.	F.L. AMPS	WEIGHT	"C" DIM.	FOOT NOTES	C FACE KIT
75	3600	208-230/460	364TS	<b>GT0042</b>	364TSTDCB6001	√	\$5,648	E1	93.6	184-166/83.0	937	29.57	YD	A168
	1800	208-230/460	365T	<b>GT0043</b>	365TTDCB6060	√	\$4,713	E1	95.0	194-174/87.0	1030	33.27	YD	A168
	1200	230/460	405T	<b>GT0044</b>	405TTDC16081	√	\$7,726	E1	94.5	180/90.0	1100	38.78	YD	A415
100	3600	208-230/460	365TS	<b>GT0045</b>	365TSTDCB6001	√	\$6,912	E1	93.6	243-222/111	1016	31.14	YD	A168
	1800	230/460	404T	<b>GT0046</b>	404TTDC6060	√	\$6,145	E1	95.4	226/113	1025	37.20	YD	A415
	1200	230/460	444T	<b>GT0047</b>	444TTDC16077	√	\$9,591	E1	95.0	232/116	1675	44.57	YD	A417
125	3600	460	404TS	<b>GT0048</b>	404TSTDC6001	√	\$8,269	E1	94.1	138	973	33.85	PW	A414
	1800	460	405T	<b>GT0049</b>	405TTDC6060	√	\$7,778	E1	95.4	140	1150	38.78	PW	A415
	1200	460	445T	<b>GT0050</b>	445TTDC16076	√	\$12,586	E1	95.0	145	1799	44.57	PW	A417
150	3600	460	405TS	<b>GT0051</b>	405TSTDC6007	√	\$9,676	E1	94.1	164	1075	35.45	PW	A414
	1800	460	444T	<b>GT0052</b>	444TTDC6060	√	\$10,442	E1	95.8	168	1275	44.57	PW	A417
	1200	460	447T	<b>GT0053</b>	447TTDC16077	√	\$12,941	E1	95.4	172	2050	49.69	PW	A419
200	3600	460	444TS	<b>GT0054</b>	444TSTDC16003	√	\$15,051	E1	95.0	215	1277	40.83	PW	A416
	1800	460	445T	<b>GT0055</b>	445TTDC6060	√	\$13,102	E1	95.8	220	1885	44.57	PW	A417
	1200	460	449T	<b>GT0056</b>	449TTDC16076	√	\$16,501	E1	95.4	228	2200	49.69	PW	A419

Catalog numbers (Cat No.) highlighted in bold blue have efficiency levels that meet EISA requirements

Blue shaded areas are Cast Iron Frames



# General Purpose, Three Phase

## Totally Enclosed

### Applications:

General purpose use on pumps, fans, blowers, compressors, conveyors, and other industrial machinery installed in damp, dusty, or dirty environments. Additionally, cast iron frame motors may be suitable for the process industries.

### Features:

- Frame constructions are heavy gauge steel or Aluminum, as noted
- Ball bearings (except as noted)
- 1.15 Service Factor (except as noted)
- 60/50 hertz at next lower horsepower, as noted
- Will accept C-Face Kits as noted, also see Accessories section
- UL Recognized and CSA Certified
- Two year warranty on EISA efficient motors (bold blue Catalog Numbers)



### Rigid Base

Suitable for use on VFD per guidelines on page 17.

HP	RPM	VOLTS	FRAME	CAT. NO.	MODEL NO.	STOCK	CT SPEED RANGE*	LIST PRICE	MULT. SYMB.	NOM. EFF.	F.L. AMPS	WEIGHT	"C" DIM.	FOOT NOTES	C FACE KITS	
1/4	1800	208-230/460	48	K151	5K32GN30	✓	----	<b>\$221</b>	F1	62.9	1.3-1.4/0.7	14	9.92	20	N/A	
	1800	230/460	48	K194	5K33KN92	✓	----	<b>\$322</b>	F1	67.5	1.2/0.6	15	9.19	17,N	N/A	
	1800	208-230/460	56	K439	5K49DN4131	✓	----	<b>\$283</b>	F1	67.4	1.1-1.2/0.6	16	9.57	17,N	A536	
	1800	575	48	K418	5K32GN53	✓	----	<b>\$299</b>	F1	61.2	0.6	16	9.92	17	N/A	
	1200	230/460	56	K321	5K35MN75	✓	----	<b>\$317</b>	F1	66.0	1.4/0.7	17	10.93	20,68	AG215	
1/3	3600	208-230/460	48	K153	5K33FN30	✓	----	<b>\$221</b>	F1	61.0	1.5-1.8/0.9	16	10.20	17	N/A	
	1800	208-230/460	56	K154	5K49FN4136	✓	----	<b>\$239</b>	F1	69.2	1.5-1.6/0.8	20	10.73	20,68	A536	
	1800	208-230/460	56	K196	5K49FN4129	✓	----	<b>\$361</b>	F1	73.4	1.3-1.4/0.7	18	9.57	17,N	A536	
	1800	575	56	G304	056T17F2043	✓	----	<b>\$239</b>	F1	65.5	0.6	25	10.22	25	N/A	
	1200	230/460	56	K155	5K36PN30	✓	----	<b>\$336</b>	F1	67.3	1.8/0.9	20	11.40	20,68	AG215	
1/2	3600	208-230/460	56	G308	056T34F5328	✓	2:1	<b>\$217</b>	F1	66.0	2.1-2.2/1.1	22	11.82	68	A437	
	3600	575	56	G309	056T34F5333	✓	2:1	<b>\$217</b>	F1	66.0	0.9	22	11.82		A437	
	1800	208-230/460	56	K158	5K35MNB117	✓	----	<b>\$267</b>	F1	76.1	2.1-2.2/1.1	17	10.93	19	AG215	
	1800	208-230/460	56	K197	5K42HN4109	✓	----	<b>\$402</b>	F1	76.9	1.8-1.8/0.9	20	9.95	17,N	A536	
	1800	575	56	K426	5K42HN4134	✓	----	<b>\$267</b>	F1	76.9	0.8	22	11.00	19,50	A536	
	1200	208-230/460	56	K159	5K49MN6079	✓	----	<b>\$369</b>	F1	72.0	2.6-2.6/1.3	27	11.43	5,19	A536	
3/4	3600	208-230/460	56	K160	5K37NN30	✓	----	<b>\$259</b>	F1	74.1	2.6-2.5/1.3	18	11.76	19	AG215	
	3600	575	56	G327	056T34F5334	✓	2:1	<b>\$259</b>	F1	74.0	1.3	23	11.82		A437	
	1800	200-208	56	G328	056T17F2045	✓	----	<b>\$295</b>	F1	75.5	3.2/3.3	21	11.22	25	N/A	
	1800	208-230/460	56	K161	5K36PNB111	✓	----	<b>\$295</b>	F1	78.9	2.8-2.8/1.4	20	11.36	19	AG215	
	1800	208-230/460	56	K198	5K49PN4113	✓	----	<b>\$414</b>	F1	80.6	2.4-2.4/1.2	31	11.38	17,N	A536	
	1800	575	56	G1340	5K36PN251	✓	----	<b>\$295</b>	F1	73.4	1.3	20	11.40	19	A536	
	1200	208-230/460	56	K162	5K46PN6082	✓	----	<b>\$382</b>	F1	76.1	2.9-2.8/1.4	31	11.83	68	AG215	
	1200	208-230/460	143T	H700	143TFR5376	✓	2:1	<b>\$371</b>	E6	74.0	3.2-3.2/1.6	28	12.37	68	A438	
	1	3600	208-230/460	56	K163	5K38RN30	✓	----	<b>\$291</b>	F1	78.5	3.2-3.0/1.5	25	12.36	19,68	AG215
		3600	575	56	G345	056T34F5335	✓	2:1	<b>\$291</b>	F1	74.0	1.5	24	11.82		A437
1800		200	143T	<b>E824</b>	143TFR4028	✓	10:1	<b>\$347</b>	E8	82.5	3.5	32	12.87		A438	
1800		208-230/460	56	G347	056T17F5302	✓	2:1	<b>\$309</b>	F1	77.0	3.5-3.6/1.8	25	12.32	68	A437	
1800		208-230/460	56	K164	5K49MN4105	✓	----	<b>\$394</b>	F1	79.2	3.6-3.8/1.9	27	11.43	17	A536	
1800		575	56	K424	5K49MN4111	✓	----	<b>\$309</b>	F1	78.2	1.7	27	11.43	19	A536	
1200		230/460	56H	K165	5K49UN6085	✓	----	<b>\$408</b>	F1	76.1	3.6/1.8	37	13.07	18,68	A536	

Catalog numbers (Cat No.) highlighted in bold blue have efficiency levels that meet EISA requirements

\* Requires nameplate modification

Continued on next page.

# General Purpose, Three Phase

## Totally Enclosed

### Rigid Base

HP	RPM	VOLTS	FRAME	CAT. NO.	MODEL NO.	STOCK	CT SPEED RANGE*	LIST PRICE	MULT. SYMB.	NOM. EFF.	F.L. AMPS	WEIGHT	"C" DIM.	FOOT NOTES	C FACE KITS
1 1/2	3600	200	143T	<b>E830</b>	143TTFR4003		2:1	\$366	E8	82.5	4.6	34	12.87		A438
	3600	208-230/460	56	K166	5K46KN2175		----	\$351	F1	77.3	5.0-4.8/2.4	24	11.83		A536
	3600	575	56	G363	056T34F5336		2:1	\$351	F1	80.0	1.8	25	11.82		A437
	1800	200	145T	<b>E836</b>	145TTFR4029	√	10:1	\$387	E8	84.0	5.1	44	14.37		A438
	1800	208-230/460	56H	K167	5K49SN4118	√	----	\$353	F1	81.7	4.7-4.4/2.2	35	13.07	5,19,68	A536
	1800	575	145T	<b>E838</b>	145TTFR4038		10:1	\$387	E8	84.0	1.8	44	14.37		A438
2	3600	200	145T	<b>E840</b>	145TTFR4005		2:1	\$424	E8	84.0	6.0	38	13.37		A438
	3600	575	56H	G368	056T34F5337		2:1	\$408	F1	80.0	2.4	29	12.32	5	A437
	3600	575	145T	<b>E843</b>	145TTFR4007		2:1	\$424	E8	84.0	2.1	38	13.37		A438
	1800	200	145T	<b>E845</b>	145TTFR4032	√	10:1	\$424	E8	84.0	64.5	46	13.87		A438
	1800	208-230/460	56	K1492	5K49ZN4252	√	----	\$393	F1	83.6	6.2-5.8/2.9	44	14.38		A536
	1800	575	145T	<b>E847</b>	145TTFR4039		10:1	\$424	E8	84.0	2.3	41	13.87		A438
3	3600	208-230/460	56H	G385	056T34F5338		2:1	\$458	F1	84.0	8.4-7.6/3.8	39	13.52	5,68	A437
	3600	575	182T	<b>U603</b>	182TTFR4005		2:1	\$480	E8	85.5	3.0	67	14.97		A644
	1800	200	182T	<b>U605A</b>	182TTFW4327	√	10:1	\$454	E8	87.5	9.7	61	12.96	13	A666
	1800	230/460	56H	G387	056T17F5327		2:1	\$418	F1	84.0	8.6/4.3	48	14.82	68	A437
	1800	575	182T	<b>U1608</b>	182TTFW4040	√	10:1	\$454	E8	87.5	3.4	61	12.96	13	A666
5	3600	200	184T	<b>U611</b>	184TTFR4003		2:1	\$593	E8	87.5	14.3	86	15.97		A644
	3600	575	184T	<b>U614</b>	184TTFR4005		2:1	\$593	E8	87.5	5.0	78	15.97		A644
	1800	200	184T	<b>U616</b>	184TTFR4038	√	10:1	\$530	E8	87.5	15.0	82	15.97		A644
	1800	200	184T	<b>U616A</b>	184TTFW4727	√	10:1	\$530	E8	87.5	15.0	71	13.96	13	A666
	1800	200	184T	<b>H1668</b>	184TTFW7727	√	2:1	\$484	E6	87.5	15.0	82	13.96	13	A666
	1800	575	184T	<b>U1619</b>	184TTFW4040		10:1	\$530	E8	87.5	5.3	70	13.96	13	A666
7 1/2	3600	200	213T	<b>U622</b>	213TTFW4003		2:1	\$775	E8	89.5	21.2	136	20.23		A609
	3600	575	213T	<b>U625</b>	213TTFW4005		2:1	\$775	E8	88.5	7.4	128	18.73		A609
	1800	200	213T	<b>U627</b>	213TTFW4028	√	10:1	\$760	E8	89.5	23.0	125	18.73		A609
	1800	575	213T	<b>U630</b>	213TTFW4030		10:1	\$760	E8	89.5	8.0	135	18.73		A609
	10	3600	200	215T	<b>U634</b>	215TTFW4003		2:1	\$905	E8	89.5	27.6	152	20.23	
10	3600	575	215T	<b>E821</b>	215TTFW4005		2:1	\$905	E8	89.5	9.6	145	20.23		A609
	1800	200	215T	<b>E822</b>	215TTFW4028	√	10:1	\$920	E8	89.5	29.9	125	20.23		A609
	1800	575	215T	<b>U640</b>	215TTFW4030		10:1	\$920	E8	89.5	10.4	138	20.23		A609
	15	3600	200	254T	<b>U643</b>	254TTFL14004		2:1	\$1,256	E8	90.2	40.5	178	22.49	AL
15	3600	575	254T	<b>U645</b>	254TTFL14005		2:1	\$1,256	E8	90.2	14.0	178	22.99	AL	A1209
	1800	200	254T	<b>U646A</b>	254TTFL4027	√	10:1	\$1,248	E8	91.0	46.0	178	22.99	AL	A1209
	20	1800	200	256T	<b>U651</b>	256TTFL14027		10:1	\$1,536	E8	91.0	58.5	247	26.24	AL
20	1800	575	256T	<b>E998</b>	256TTFL14030		10:1	\$1,536	E8	91.0	20.4	286	26.24	AL	A1209

Catalog numbers (Cat No.) highlighted in bold blue have efficiency levels that meet EISA requirements

\* Requires nameplate modification

# Blue Chip® General Purpose, Three Phase

## Totally Enclosed

### Applications:

General Purpose use on pumps, fans, blowers, compressors, conveyors, and other industrial machinery installed in damp, dusty, or dirty environments. Additionally, cast iron frame motors may be suitable for the process industries..

### Features:

- Frame constructions are heavy gauge steel or Aluminum, as noted
- 1.15 Service Factor
- Nameplated 60/50 hertz at next lowest horsepower
- Will accept C-Face Kits as noted, also see Accessories section
- Severe duty kits available, see Accessories section
- Shaft slinger, regreasable bearings (182T and larger), lead lugs (364T and larger), and bearing caps on 444T and larger
- Ball Bearings, except where noted
- UL Recognized and CSA Certified
- Two year warranty on EISA efficient motors (bold blue Catalog Numbers)



### Rigid Base

Suitable for use on VFD per guidelines on page 17.

HP	RPM	VOLTS	FRAME	CAT. NO.	MODEL NO.	STOCK	CT SPEED RANGE*	LIST PRICE	MULT. SYMB.	NOM. EFF.	F.L. AMPS	WEIGHT	"C" DIM.	FOOT NOTES	C FACE KITS	
3/4	1200	208-230/460	143T	<b>H457</b>	143TTFN8076	√	2:1	\$371	E6	74.0	3.1-3.2/1.6	46	12.04	68	A603	
	1	1800	200	143T	<b>E825</b>	143TTTN4028		1000:1	\$366	E1	82.5	3.7	50	10.43	N	A603
		1800	208-230/460	143T	<b>E826</b>	143TTTC4026	√	1000:1	\$366	E1	85.5	3.2-3.0/1.5	51	10.43	N,68	A603
	1800	575	143T	<b>E828</b>	143TTTN4030		1000:1	\$366	E1	82.5	1.3	50	10.43	N	A603	
	1200	230/460	145T	<b>E829</b>	145TTTN4076	√	1000:1	\$467	E1	80.0	3.4/1.7	58	11.43	N,68	A655	
	1200	575	145T	<b>U672</b>	145TTTN4080	√	1000:1	\$467	E1	80.0	1.3	57	11.43	N	A655	
	900	230/460	182T	<b>L409A</b>	182TTFN4101	√	-----	\$760	E8	74.0	4.4/2.2	92	15.87	68	A641	
1 1/2	3600	200	143T	<b>E831</b>	143TTTN4003		1000:1	\$386	E1	86.5	4.6	60	10.43	N	A603	
	3600	208-230/460	143T	<b>E833</b>	143TTTN4001	√	1000:1	\$386	E1	82.5	4.4-4.0/2.0	51	10.43	N,68	A603	
	3600	575	143T	<b>E835</b>	143TTTN4005		1000:1	\$386	E1	86.5	1.6	42	10.43	N	A603	
	1800	200	145T	<b>U601</b>	145TTTN4032		1000:1	\$406	E1	84.0	5.1	62	11.43	N	A655	
	1800	208-230/460	145T	<b>E837</b>	145TTTC4026	√	1000:1	\$406	E1	84.0	4.6-4.2/2.1	58	11.43	N,68	A655	
	1800	575	145T	<b>E839</b>	145TTTN4035	√	1000:1	\$406	E1	84.0	1.8	62	11.43	N	A655	
	900	230/460	184T	<b>L410A</b>	184TTFS14101	√	-----	\$876	E8	78.5	6.1/3.05	99	15.81	68	A644	
	900	230/460	184T	<b>L410B</b>	184TTFN4102	√	-----	\$876	E8	77.0	6.1/3.05	128	15.87	68	A641	
	2	3600	200	145T	<b>E841</b>	145TTTN4003		1000:1	\$447	E1	86.5	6.0	70	11.43	N	A655
		3600	208-230/460	145T	<b>E842</b>	145TTTN4001	√	1000:1	\$447	E1	84.0	5.8-5.4/2.7	66	11.43	N,68	A655
3600		575	145T	<b>E844</b>	145TTTN4005		1000:1	\$447	E1	86.5	2.1	66	11.43	N	A655	
1800		200	145T	<b>U606</b>	145TTTN4030		1000:1	\$447	E1	85.5	6.9	64	11.43	N	A655	
1800		208-230/460	145T	<b>E846</b>	145TTTC4027	√	1000:1	\$447	E1	84.0	6.0-5.6/2.8	60	11.43	N,68	A655	
1800		575	145T	<b>E848</b>	145TTTN4040	√	1000:1	\$447	E1	85.5	2.4	64	11.43	N	A655	
900		230/460	213T	<b>L411A</b>	213TTFN4103	√	-----	\$1,231	E8	82.5	7.5/3.75	189	18.22	68	A646	
3	3600	575	182T	<b>U604</b>	182TTFS4005		2:1	\$503	E1	85.5	3.0	81	14.81		A644	
	900	230/460	215T	<b>L421A</b>	215TTFS14103	√	-----	\$1,603	E8	84.0	10.6/5.3	167	19.72	68	A206	
	5	3600	575	184T	<b>U615</b>	184TTFS4005		2:1	\$622	E1	87.5	4.9	106	15.81		A644
1800		575	184T	<b>U620</b>	184TTFS4030		10:1	\$556	E1	87.5	5.2	102	15.81		A644	
900		230/460	254T	<b>L412A</b>	254TTFNA14103	√	-----	\$2,213	E8	87.5	15.0/7.5	534	23.52	68	A239	
7 1/2	3600	575	213T	<b>U671</b>	213TTFS4005		2:1	\$815	E1	88.5	7.6	191	18.2		A206	
	1800	575	213T	<b>U631</b>	213TTFS4030		10:1	\$797	E1	89.5	8.0	174	18.2		A206	
	900	230/460	256T	<b>L413A</b>	256TTFNA14101	√	-----	\$2,816	E8	86.5	23.0/11.5	312	25.27	68	A239	
10	3600	575	215T	<b>U637</b>	215TTFS4005		2:1	\$950	E1	90.2	9.6	184	19.70		A206	
	1800	575	215T	<b>U641</b>	215TTFS4030		10:1	\$966	E1	89.5	10.0	222	19.70		A206	
	900	230/460	284T	<b>L414A</b>	248TTFNA14102	√	-----	\$3,337	E8	84.0	31.0/15.5	388	26.26	68	A239	
15	3600	575	254T	<b>U638</b>	254TTFPA4005		2:1	\$1,319	E1	90.2	14.4	260	23.69		A239	
	1800	575	254T	<b>U648</b>	254TTFNA4030		10:1	\$1,311	E1	91.0	15.6	308	23.52		A284	
	900	230/460	286T	<b>L415A</b>	286TTFNA14106	√	-----	\$4,385	E8	86.5	45.0/22.5	421	28.97	68	A617	

GENERAL PURPOSE THREE PHASE

Catalog numbers (Cat No.) highlighted in bold blue have efficiency levels that meet EISA requirements

Blue shaded areas are Cast Iron Frames

√ Requires nameplate modification

Continued on next page.

# General Purpose, Three Phase

## Totally Enclosed

### Rigid Base

Suitable for use on VFD per guidelines on page 17.

HP	RPM	VOLTS	FRAME	CAT. NO.	MODEL NO.	STOCK	CT SPEED RANGE*	LIST PRICE	MULT. SYMB.	NOM. EFF.	F.L. AMPS	WEIGHT	"C" DIM.	FOOT NOTES	C FACE KITS	
20	3600	575	256T	<b>U650</b>	256TTFNA4005		2:1	\$1,732	E1	90.2	18.8	310	25.27		A284	
	1800	575	256T	<b>U653</b>	256TTFNA4030		10:1	\$1,613	E1	91.0	20.0	331	25.27		A284	
	900	230/460	324T	<b>L416A</b>	324TTFS14101	✓	---	\$5,284	E8	87.5	64.0/32.0	512	28.97	68	A214	
25	3600	575	284TS	<b>U654</b>	284TSTFPA4005		2:1	\$2,092	E1	91.0	24.0	545	24.89		A617	
	1800	575	284T	<b>E800</b>	284TTFPA4030		10:1	\$1,901	E1	92.4	24.8	324	26.27		A617	
	1800	200	284T	<b>U655</b>	284TTFPA4028		10:1	\$1,901	E1	92.4	71.0	374	31.87		A617	
	900	230/460	326T	<b>L417A</b>	326TTFS14101	✓	---	\$6,258	E8	88.5	78.0/39.0	625	30.32	68	A214	
30	3600	575	286TS	<b>E819</b>	286TSTFPA4005		2:1	\$2,306	E1	91.0	28.8	406	26.30		A617	
	1800	575	286T	<b>E817</b>	286TTFPA4030		10:1	\$2,308	E1	92.4	29.6	406	27.76		A617	
	900	460	364T	<b>L420</b>	364TTFS8101	✓	---	\$6,526	E6	91.0	41.0	886	31.50	68,89	A395	
40	1800	575	324T	<b>E815</b>	324TTFPA4030		2:1	\$2,985	E1	93.0	40.0	555	28.97		A619	
	900	460	365T	<b>L425</b>	365TTFS8115	✓	---	\$8,085	E6	91.0	53.5	970	32.50	68,89	A395	
50	1800	575	326T	<b>U659</b>	326TTFPA4030		2:1	\$3,843	E1	93.0	49.0	589	30.47		A619	
	900	460	404T	<b>L426</b>	404TTFS8102	✓	---	\$9,632	E6	92.4	69.0	1191	35.62	68,89	A223	
60	1800	575	364T	<b>U660</b>	364TTFS4040		2:1	\$5,639	E1	93.6	57.5	952	31.50		A395	
	900	460	405T	<b>L427</b>	405TTFS8114	✓	---	\$11,169	E6	91.7	81.0	1340	37.12	68,89	A223	
75	1800	575	365T	<b>E805</b>	365TTFS4040		2:1	\$7,207	E1	94.1	71.0	1053	32.50		A395	
	900	460	444T	<b>L428</b>	444TTFS8106	✓	---	\$14,875	E6	93.0	97.0	1820	41.25	68,89	A229	
100	900	460	445T	<b>L429</b>	445TTFN8115	✓	---	\$18,794	E6	93.6	133	2377	43.19	68	A620	
125	900	460	445T	<b>L440</b>	445TTFN8102		---	\$21,852	E6	93.6	169	2377	43.19	H,RB,68	N/A	
150	900	460	447/9	<b>L442</b>	449TTFS8111		---	\$24,652	E6	94.5	206	2872	51.69	H,RB,68	N/A	
200	900	460	L447/9T	<b>L449</b>	449TTFS8110	✓	---	\$25,074	E6	94.5	270	3225	51.69	H,RB,YD,68	N/A	
250	3600	460	447/9TS	<b>L451A</b>	449TSTFS14007	✓	---	\$26,869	E9	95.4	275	2079	48.11	H,YD,68	A624	
	1800	460	445T	<b>L452</b>	445TTFN8040	✓	---	\$18,916	E9	95.0	285	2395	43.19	H,RB,YD,68	N/A	
	1800	460	447/9T	<b>L455</b>	449TTFS8028		---	\$20,335	E9	95.0	290	2802	51.69	H,YD,68	A623	
	1800	460	447/9T	<b>L454</b>	449TTFS8038	✓	---	\$20,335	E9	95.0	290	2775	51.69	H,RB,YD,68	N/A	
	1800	575	445T	<b>L453</b>	445TTFN8041		---	\$18,916	E9	95.0	228	2394	43.19	RB	N/A	
	1200	460	447/9T	<b>L456</b>	449TTFS8087	✓	---	\$21,131	E9	95.4	300	2895	51.69	H,RB,YD,68	N/A	
	1200	460	447/9T	<b>L457</b>	449TTFS8077		---	\$21,131	E9	95.4	300	3092	51.69	H,YD,68	A623	
	900	460	L447/9T	<b>L471</b>	449TTFS18105		---	\$23,108	E6	94.5	330	3586	56.71	H,RB,YD,17	N/A	
	300	3600	460	447/9TS	<b>L459</b>	449TSTFS8002	✓	---	\$28,760	E9	95.4	330	2633	47.88	H,YD,68	A624
	1800	460	447/9T	<b>L462</b>	449TTFS8037	✓	---	\$21,396	E9	95.4	338	2717	51.69	H,RB,YD,68	N/A	
300	1800	575	447/9T	<b>L472A</b>	---		---	\$22,872	E9	95.4	330	2900	51.86	H,RB,YD	A623	
	1800	460	447/9T	<b>L463</b>	449TTFS8027	✓	---	\$22,872	E9	95.4	338	3041	51.69	H,YD,68	A623	
	1200	460	L447/9T	<b>L465</b>	449TTFS8076		---	\$24,543	E9	95.4	360	3440	51.69	H,YD,17,68	A623	
	1200	460	447/9T	<b>L464</b>	449TTFS8086	✓	---	\$24,543	E9	95.4	360	3428	51.69	H,RB,YD,17,68	N/A	
	350	3600	460	447/9TS	<b>L466</b>	449TSTFS8001	✓	---	\$33,035	E9	95.4	380	2931	47.88	H,YD,68	A624
	1800	460	L447/9T	<b>L467</b>	449TTFS8036	✓	---	\$24,420	E9	95.4	400	3042	51.69	H,RB,YD	N/A	
400	1800	460	447/9T	<b>L469A</b>	449TTFS14043	✓	---	\$27,882	E9	95.4	469	3088	51.86	H,RB,17	N/A	

Catalog numbers (Cat No.) highlighted in bold blue have efficiency levels that meet EISA requirements

Blue shaded areas are Cast Iron Frames

\* Requires nameplate modification

# General Purpose, Three Phase

## Totally Enclosed

### Applications:

General purpose use on gear reducers, pumps, machine tools, and other direct-coupled equipment installed in damp, dusty, or dirty environments. Additionally, cast iron frame motors may be suitable for the process industries.

### Features:

- Ball bearings, mechanically locked on shaft end (excludes 5K models)
- Rated 60/50 hertz, 190/380 or 380 volt, at next lower horsepower (as noted)
- 1.15 Service Factor (except as noted)
- Rolled steel 56-145T frame motors accept brake kits, see Accessories section (except as noted)
- UL Recognized and CSA Certified



## C-Face Footless

Suitable for use on VFD per guidelines on page 17.

HP	RPM	VOLTS	FRAME	CAT. NO.	MODEL NO.	STOCK	CT SPEED RANGE*	LIST PRICE	MULT. SYMB.	NOM. EFF.	F.L. AMPS	WEIGHT	"C" DIM.	FOOT NOTES
1/4	1800	208-230/460	56C	K252	5K49DN4130	✓	----	\$237	F1	67.4	1.1-1.2/0.6	16	9.52	N,20,24,68
	1800	575	56C	K405	056T17F2047		----	\$237	F1	62.0	0.5	13	9.94	24
1/3	3600	208-230/460	56C	P101	056T34T5306	✓	2:1	\$205	F1	64.0	1.7-2.0/1.0	18	9.94	N,68
	1800	208-230/460	56C	K253	5K33JNA943	✓	----	\$253	F1	68.8	1.5-1.6/0.8	16	10.60	24,68,111
1/2	1800	575	56C	K522	5K33KN67	✓	----	\$253	F1	71.1	0.6	16	10.60	20,24,68
	3600	208-230/460	56C	P102	056T34F5321	✓	2:1	\$228	F1	66.0	2.1-2.2/1.1	21	11.82	68
3/4	1800	208-230/460	56C	K254	5K35MNB114	✓	----	\$295	F1	76.1	2.1-2.2/1.1	17	10.93	19,24
	1800	575	56C	K469	5K42HN4137	✓	----	\$295	F1	76.9	0.8	22	11.01	19,24,68
	1200	208-230/460	56C	K1316	5K49MN6020	✓	----	\$464	F1	72.0	2.6-2.6/1.3	27	11.44	19,24
	3600	208-230/460	56C	P103	056T34F5322	✓	2:1	\$270	F1	72.0	3.0-3.2/1.6	22	11.82	68
1	1800	208-230/460	56C	K255	5K36PNB116	✓	----	\$325	F1	78.9	2.8-2.8/1.4	20	11.36	19,24,68
	1800	575	56C	K523	5K36PN254	✓	----	\$325	F1	73.4	1.3	20	11.36	19,24,68
	1200	208-230/460	143TC	K1318	5K49PN8030	✓	----	\$480	E6	76.1	2.9-2.8/1.4	31	12.56	24
	1200	208-230/460	56C	K1317	5K49PN6025	✓	----	\$472	F1	76.1	2.9-2.9/1.4	31	12.44	24
	1200	208-230/460	56C	K404	056T11F5320		2:1	\$392	F1	74.0	3.1-3.2/1.6	26	12.32	68
	3000	208-220/440	56C	K633	5K36MN4152	✓	----	\$400	F1	77.0	3.6-3.6/1.8	20	11.36	17,24,68
	3600	208-230/460	56C	P104	056T34F5323	✓	2:1	\$303	F1	74.0	3.7-3.7/1.85	24	11.82	68
	1800	208-230/460	56C	K256	5K49MN4104	✓	----	\$332	F1	79.2	3.6-3.8/1.9	27	11.44	19,24,68
1 1/2	1800	208-230/460	143TC	<b>C220A</b>	143TTFR4329	✓	2:1	\$375	E8	82.5	3.2-3.0/1.5	35	12.87	68
	1800	575	56C	K524	5K49MN4112	✓	----	\$332	F1	78.2	1.7	27	11.44	19,24
	1800	575	143TC	C230	143TTFR5333		2:1	\$348	E6	77.0	1.5	26	12.37	
	1800	575	143TC	<b>C230A</b>	143TTFR4333		2:1	\$375	E8	82.5	1.2	32	12.37	
	1200	208-230/460	145TC	<b>C250A</b>	145TTFR4378	✓	2:1	\$469	E8	80.0	3.6-3.4/1.7	39	13.37	68
	1200	208-230/460	56C	K1490	5K49PN6164	✓	----	\$483	F1	74.2	3.9-3.8/1.9	31	12.44	24
	1200	208-230/460	56C	K407	056T11F5321		2:1	\$419	F1	77.0	3.8-3.6/1.8	33	12.82	68
	3600	208-230/460	56C	P105	056T34F5324	✓	2:1	\$352	F1	80.0	4.6/2.3	25	11.82	68
	3600	208-230/460	56C	KG235	5K49PN2348	✓	----	\$434	F1	81.7	4.8-4.2/2.1	31	12.44	24,68,111
	3600	208-230/460	143TC	C201	143TTFR5302	✓	2:1	\$360	E6	80.0	4.7-4.6/2.3	35	11.87	d,68
2	3600	208-230/460	143TC	<b>C201A</b>	143TTFR4302	✓	2:1	\$388	E8	82.5	4.4-4.0/2.0	41	11.87	68
	1800	208-230/460	56C	K257	5K49SN4117	✓	----	\$365	F1	81.7	4.7-4.4/2.2	35	12.44	19,24,68
	1800	208-230/460	145TC	<b>C221A</b>	145TTFR4332	✓	2:1	\$436	E8	84.0	4.6-4.4/2.2	38	14.37	68
	1800	575	56C	G548	056T17F5320		2:1	\$365	F1	80.0	1.9	31	12.32	
	1800	575	145TC	<b>C231</b>	145TTFR5340		2:1	\$405	E6	80.0	1.9	29	12.37	
	1800	575	145TC	<b>C231A</b>	145TTFR4340		2:1	\$436	E8	84.0	1.8	38	14.37	
	1200	230/460	182TC	<b>C251A</b>	---		2:1	\$845	E8	75.5	5.0/2.5	89	17.93	F,68
	3600	208-230/460	56C	P106	056T34F5325	✓	2:1	\$408	F1	80.0	6.0-6.0/3.0	29	12.32	68
	3600	208-230/460	56C	KG237	5K49SN2187	✓	----	\$497	F1	83.0	5.8-5.4/2.7	35	12.97	24,68,110
	3600	208-230/460	145TC	<b>C202A</b>	145TTFR4306	✓	2:1	\$451	E8	84.0	5.6-5.2/2.6	38	13.37	68
2	1800	208-230/460	56C	K1491	5K49ZN4253	✓	----	\$393	F1	83.6	6.2-5.8/2.9	45	14.25	24,68
	1800	208-230/460	145TC	<b>K2033</b>	5KE48WN8365	✓	----	\$533	E6	84.0	6.5-6.2/2.8	43	13.84	24,68
	1800	575	56C	G549	056T17F5329		2:1	\$393	F1	82.5	2.3	41	13.82	
	1800	575	145TC	C232	145TTFR5341		2:1	\$433	E6	82.5	2.3	41	13.87	
	1800	575	145TC	<b>C232A</b>	145TTFR14048		2:1	\$466	E8	84.0	2.3	49	14.87	
	1200	230/460	184TC	<b>C252A</b>	---		2:1	\$947	E8	80.0	6.7/3.35	89	15.69	F,24,68

Catalog numbers (Cat No.) highlighted in bold blue have efficiency levels that meet EISA requirements

\* Requires nameplate modification

Continued on next page.

# General Purpose, Three Phase

Totally Enclosed

C-Face Footless

HP	RPM	VOLTS	FRAME	CAT. NO.	MODEL NO.	STOCK	CT SPEED RANGE*	LIST PRICE	MULT. SYMB.	NOM. EFF.	F.L. AMPS	WEIGHT	"C" DIM.	FOOT NOTES
3	3600	208-230/460	56C	P107	056T34F5326	✓	2:1	\$443	F1	84.0	8.4-7.6/3.8	38	13.32	68
	3600	208-230/460	145TC	<b>C236A</b>	145TTFR4307	✓	2:1	\$451	E8	85.8	8.4-7.6/3.8	39	13.37	68
	3600	208-230/460	182TC	<b>C203B</b>	182TTFW14004	✓	2:1	\$575	E8	85.5	8.2-7.4/3.7	65	13.97	F,13,24,68
	1800	208-230/460	182TC	<b>C223B</b>	182TTFW4027	✓	2:1	\$552	E8	87.5	8.8-8.4/4.2	64	12.97	13,68
	1800	230/460	56C	K640	5K49QN4609	✓	-----	\$484	F1	84.7	8.2/4.1	54	14.89	17,24,68
	1200	230/460	213TC	<b>C253A</b>	213TTFW14081		2:1	\$787	E8	81.5	9.6/4.8	108	19.46	F,24,68
5	3600	208-230/460	184TC	<b>C204B</b>	184TTFW14004	✓	2:1	\$660	E8	87.5	13.4-12.2/6.1	74	14.47	13,68
	1800	208-230/460	184TC	<b>C1224</b>	184TTFW8641	✓	2:1	\$576	E8	87.5	16-14.8/7.4	70	13.97	13,68
	1200	208-230/460	215TC	<b>C254A</b>	215TTFW14084		2:1	\$1,096	E8	87.5	16.0-14.8/7.4	179	20.96	24,68
7 1/2	3600	208-230/460	184TC	<b>C238B</b>	184TTFW14021	✓	2:1	\$791	E8	88.5	18.5-16.8/8.4	95	15.97	13,68
	3600	208-230/460	213TC	<b>C205A</b>	213TTFW14011	✓	2:1	\$873	E8	88.5	21.0-19.2/9.6	84	19.46	F,24,68
	1800	208-230/460	213TC	<b>C225A</b>	213TTFW14045	✓	2:1	\$766	E8	89.5	22.0-19.4/9.7	110	19.46	F,24,68
	1200	230/460	254TC	<b>C255A</b>	254TTF14078		-----	\$1,481	E8	89.5	22.0/11.0	148	23.24	AL,F,24,68
10	3600	208-230/460	215TC	<b>C206A</b>	215TTFW14024	✓	2:1	\$1,044	E8	89.5	27.0-24.0/12.0	142	20.96	F,24,68
	1800	208-230/460	215TC	<b>C226A</b>	215TTFW14041	✓	2:1	\$1,006	E8	89.5	28.0-26.0/13.0	138	20.96	F,24,68
	1200	230/460	256TC	<b>C256A</b>	256TTFNA14086		-----	\$1,831	E8	89.5	26.0/13.0	375	25.94	F,24,68
15	3600	208-230/460	215TC	<b>C237A</b>	215TTFW14022	✓	2:1	\$1,327	E8	90.2	39.0-36.0/18.0	154	20.96	F,24,68
	3600	230/460	254TC	<b>C207A</b>	254TTF14009		-----	\$1,443	E8	90.2	35.0/17.5	210	23.24	AL,F,24,68
	1800	208-230/460	254TC	<b>C227A</b>	254TTF14037	✓	-----	\$1,429	E8	91.0	42.0-40.0/20.0	199	23.24	AL,F,24,68

Catalog numbers (Cat No.) highlighted in bold blue have efficiency levels that meet EISA requirements

Blue shaded areas are Cast Iron Frames

\* Requires nameplate modification

# General Purpose, Three Phase

## Totally Enclosed (Four in One)

### Features:

- Ball bearings, mechanically locked on shaft end (excludes 5K models)
- 1.15 Service Factor (except as noted)
- Class F insulation (except as noted)
- Rated 60/50 hertz, 190/380 or 380 volt, at next lower horsepower (as noted) 56-145T frame motors, accept brake kits, see accessory kits
- UL Recognized and CSA Certified
- Two year warranty on EPAct and NEMA Premium efficient (bold blue catalog numbers)



### Additional features for "Four-In-One" motors only:

- CR200 Corona resistant magnet wire
- Bolt-on, removable rigid base
- Suitable for horizontal and vertical mounting
- Will accept drip cover kits, see Accessories section



## C-Face Footed (Rigid and Removable Base)

Suitable for use on VFD per guidelines on page 17.

HP	RPM	VOLTS	FRAME	"FOUR IN-ONE"	CAT. NO.	MODEL NO.	STOCK	CT SPEED RANGE*	LIST PRICE	MULT. SYMB.	NOM. EFF.	F.L. AMPS	WEIGHT	"C" DIM.	FOOT NOTES
1/4	1800	208-230/460	56C		G565	056T17F2051		2:1	\$242	F1	62.5	1.2-1.4/0.7	14	9.94	BI,24,68
	1200	208-230/460	56C	YES	G586	056T11F5311	✓	2:1	\$343	F2	52.5	1.7-2.0/1.0	19	11.31	6,13,68
1/3	3600	208-230/460	56C	YES	D390	056T34T5303	✓	1000:1	\$217	F2	66.0	1.7-1.8/0.9	20	10.43	N,6,13,24,68
	3600	575	56C	YES	K702	056T34T5309		1000:1	\$217	F2	64.0	0.8	19	9.93	N,6,13,24
	1800	208-230/460	56C		K1322	5K42FN4035	✓	---	\$270	F1	69.2	1.5-1.6/0.8	20	11.01	20,24,68
	1800	208-230/460	56C	YES	G580	056T17T5305	✓	1000:1	\$278	F2	68.0	1.4-1.6/0.8	20	9.93	N,6,13,24,68
	1800	575	56C	YES	K703	056T17T5316	✓	1000:1	\$278	F2	68.0	0.7	20	9.93	N,6,13,24
1/2	1200	208-230/460	56C	YES	G587	056T11F5310	✓	10:1	\$361	F2	62.0	1.9-2.2/1.1	21	11.31	6,13,68
	3600	208-230/460	56C		G569	056T34F5308		2:1	\$233	F1	66.0	2.1-2.2/1.1	23	11.82	BI,13,68
	3600	208-230/460	56C	YES	D391	056T34F5301	✓	10:1	\$242	F2	66.0	2.1-2.2/1.1	22	11.81	6,13,68
	3600	575	56C	YES	K704	056T34F5348	✓	10:1	\$242	F2	66.0	0.9	22	11.81	6,13
	1800	208-230/460	56C		K1324	5K42HN4034	✓	---	\$299	F1	74.7	2.3-2.2/1.1	22	11.01	19,24,68
	1800	208-230/460	56C	YES	G581	056T17F5321	✓	10:1	\$308	F2	68.0	2.3-2.4/1.2	24	11.81	6,13,68
	1800	575	56C	YES	K705	056T17F5336	✓	10:1	\$308	F2	68.0	1.0	23	11.81	6,13
	1200	208-230/460	56C	YES	G588	056T11F5309	✓	10:1	\$393	F2	68.0	2.4-2.7/1.35	23	11.81	6,13,68
3/4	3600	208-230/460	56C	YES	D392	056T34F5302	✓	4:1	\$282	F2	68.0	3.0-3.2/1.6	23	11.81	6,13,68
	3600	575	56C	YES	K706	056T34F5349	✓	4:1	\$282	F2	68.0	1.3	23	11.81	6,13
	1800	208-230/460	56C		K258	5K49KN4124	✓	---	\$330	F1	74.3	3.3-3.0/1.5	24	11.41	19,24,68
	1800	208-230/460	56C	YES	G582	056T17F5322	✓	10:1	\$337	F2	75.5	2.6-3.0/1.5	40	11.81	6,13,68
	1800	575	56C	YES	K707	056T17F5337	✓	10:1	\$337	F2	75.5	1.2	24	11.81	6,13
	1200	208-230/460	56C	YES	G589	056T11F5308	✓	4:1	\$405	F2	74.0	3.1-3.2/1.6	27	12.31	6,13,68
1	3600	208-230/460	56C		K500	5K38RN106	✓	---	\$307	F1	78.5	3.2-3.0/1.5	32	12.4	19,24,68
	3600	208-230/460	56C	YES	D393	056T34F5303	✓	4:1	\$314	F2	74.0	3.7-3.7/1.85	25	11.81	6,13,68
	3600	575	56C	YES	K708	056T34F5350	✓	4:1	\$314	F2	77.0	1.5	25	11.81	6,13
	1800	208-230/460	56C		K259	5K49MN4110	✓	---	\$336	F1	79.2	3.6-3.8/1.9	27	11.41	19,24,68
	1800	208-230/460	56HC	YES	G583	056T17F5323	✓	10:1	\$344	F2	77.0	3.5-3.6/1.8	26	12.31	5,6,13,68
	1800	575	56HC	YES	K709	056T17F5338	✓	4:1	\$344	F2	77.0	1.5	27	12.31	5,6,13
	1200	208-230/460	56HC	YES	K701	056T11F5307	✓	4:1	\$433	F2	77.0	3.95-4.0/2.0	32	12.81	5,6,13,68

Catalog numbers (Cat No.) highlighted in bold blue have efficiency levels that meet EISA requirements

\* Requires nameplate modification

Continued on next page.

# General Purpose, Three Phase

## Totally Enclosed

### C-Face Footed (Rigid and Removable Base)

HP	RPM	VOLTS	FRAME	"FOUR IN-ONE"	CAT. NO.	MODEL NO.	STOCK	CT SPEED RANGE*	LIST PRICE	MULT. SYMB.	NOM. EFF.	F.L. AMPS	WEIGHT	"C" DIM.	FOOT NOTES	
1 1/2	3600	230/460	143TC		U733	143TTFR4010	✓	2:1	\$436	E8	82.5	4.0/2.0	35	12.87	d,68	
	3600	208-230/460	56C	YES	D394	056T34F5304	✓	2:1	\$375	F2	80.0	4.7-4.6/2.3	25	11.81	6,13,68	
	3600	575	56C	YES	K721	056T34F5351	✓	2:1	\$375	F2	80.0	1.8	26	11.81	6,13	
	1800	200	145TC		<b>U703</b>	145TTFR4046		10:1	\$415	E8	84.0	5.1	44	14.37		
	1800	208-230/460	56HC		K260	5K49SN4119	✓	---	\$369	F1	81.7	4.7-4.4/2.2	35	12.44	19,24,50	
	1800	575	145TC		<b>U705</b>	145TTFR4052		10:1	\$415	E8	84.0	1.8	44	14.37	6	
	1800	208-230/460	56HC	YES	G584	056T17F5324	✓	10:1	\$376	F2	80.0	4.8-4.8/2.4	30	12.31	5,6,13,68	
	1800	575	56HC	YES	K722	056T17F5339	✓	2:1	\$376	F2	80.0	1.9	29	12.31	5,6,13	
	1200	230/460	56HC	YES	K700	056T11F5328	✓	2:1	\$460	F2	77.5	5.8/2.9	42	14.32	5,6,13,17	
	2	3600	208-230/460	56HC	YES	D395	056T34F5305	✓	2:1	\$433	F2	80.0	6.0-6.0/3.0	29	12.31	5,6,13,68
3600		575	56HC	YES	K723	056T34F5352	✓	2:1	\$433	F2	80.0	2.4	30	12.31	5,6,13	
1800		200	145TC		<b>U706</b>	145TTFR4070		10:1	\$445	E8	84.0	6.4	42	13.87		
1800		208-230/460	56HC		K806	056T17F5330	✓	2:1	\$410	F1	82.5	6.0-5.8/2.9	40	13.82	BI,5,68	
1800		575	145TC		<b>U708</b>	145TTFR4126		10:1	\$445	E8	84.0	2.2	42	13.87		
1800		208-230/460	56HC	YES	G585	056T17F5325	✓	10:1	\$409	F2	82.5	6.0-5.8/2.9	40	13.81	5,6,13,68	
1800		575	56HC	YES	K724	056T17F5340	✓	4:1	\$409	F2	82.5	2.3	39	13.81	5,6,13	
1200		230/460	184TC	YES	<b>C380B</b>	184TTFW16051	✓	10:1	\$866	E8	88.5	6.4/3.2	74	14.97	6,13,24,68	
3		3600	200	182TC		<b>U736</b>	182TTFR4013		2:1	\$622	E8	85.5	8.5	76	15.69	24,13
		3600	208-230/460	56HC	YES	D396	056T34F5306	✓	2:1	\$481	F2	84.0	8.4-7.6/3.8	40	13.31	5,6,13,68
	3600	575	56HC	YES	K725	056T34F5353	✓	2:1	\$481	F2	84.0	3.1	40	13.31	5,6,13	
	3600	208-230/460	182TC	YES	C381	182TTFR4320	✓	10:1	\$756	E8	85.5	8.2-7.4/3.7	76	15.50	d,6,24,68	
	3600	208-230/460	182TC	YES	<b>C381B</b>	182TTFW16021	✓	10:1	\$884	E8	86.5	8.2-7.4/3.7	75	14.47	6,13,24,68	
	1800	230/460	56HCZ	YES	G590	056T17F5355	✓	---	\$460	F2	85.5	8.6/4.3	48	14.87	Z,5,6,13,17,68	
	1800	575	56HCZ	YES	G591	056T17F5356		---	\$460	F2	85.5	3.4	48	14.87	Z,5,6,13,17	
	1800	208-230/460	182TC	YES	<b>C382B</b>	182TTFW16030	✓	10:1	\$790	E8	89.5	8.6-7.8/3.9	75	14.47	6,13,24,68	
	1800	575	182TC	YES	<b>C383A</b>	182TTFW4345		10:1	\$676	E8	87.5	3.4	76	15.50	6,13,24	
	1800	575	182TC	YES	<b>C383B</b>	182TTFW16027	✓	10:1	\$790	E8	89.5	3.2	89	14.97	6,13,24	
5	1200	208-230/460	213TC	YES	<b>C384A</b>	213TTFW16078	✓	10:1	\$1,105	E8	89.5	9.2-8.8/4.4	123	20.97	6,24,68	
	3600	200	184TC		<b>U738</b>	184TTFR4013		2:1	\$731	E8	87.5	14.2	90	16.69	24,13	
	3600	230/460	184TC	YES	<b>C385B</b>	184TTFW16006	✓	10:1	\$944	E8	88.5	13.1-12.0/6.0	94	14.97	13,24,68	
	1800	230/460	184TC	YES	<b>C386B</b>	184TTFW16027	✓	10:1	\$833	E8	89.5	12.6/6.3	85	14.97	13,24,68	
	1800	575	184TC	YES	C387	184TTFR4345	✓	10:1	\$712	E8	87.5	5.2	86	16.50	d,6,24	
	1800	575	184TC	YES	C387A	184TTFW4345	✓	10:1	\$712	E8	87.5	5.2	72	16.50	d,6,13,24,68	
	1800	575	184TC	YES	<b>C387B</b>	184TTFW16029	✓	10:1	\$833	E8	89.5	5.1	72	14.97	6,13,24,68	
	1200	208-230/460	215TC	YES	<b>C388A</b>	215TTFW16079	✓	10:1	\$1,318	E8	90.2	15.0-14.0/7.0	157	22.22	6,13,24,68	

Catalog numbers (Cat No.) highlighted in bold blue have efficiency levels that meet EISA requirements

\* Requires nameplate modification

Continued on next page.



# General Purpose, Three Phase

## Totally Enclosed

### C-Face Footed (Rigid and Removable Base)

HP	RPM	VOLTS	FRAME	"FOUR IN-ONE"	CAT. NO.	MODEL NO.	STOCK	CT SPEED RANGE*	LIST PRICE	MULT. SYMB.	NOM. EFF.	F.L. AMPS	WEIGHT	"C" DIM.	FOOT NOTES
7 1/2	3600	200	213TC		<b>U740</b>	213TTFW4007		2:1	\$958	E8	89.5	21.2	118	20.97	24
	3600	575	213TC		<b>U742</b>	213TTFW4008		2:1	\$958	E8	89.5	7.4	118	20.97	24
	3600	208-230/460	213TC	YES	<b>C389A</b>	213TTFW16008	✓	10:1	\$1,225	E8	90.2	19.6-17.8/8.9	125	20.97	6,24,68
	1800	208-230/460	213TC	YES	<b>C390A</b>	213TTFW16035	✓	10:1	\$1,105	E8	91.7	21.0-18.6/9.3	157	22.22	6,24,68
	1800	575	213TC	YES	<b>C391</b>	213TTFW4345		10:1	\$945	E8	89.5	8.0	122	20.97	d,6,24
	1800	575	213TC	YES	<b>C391A</b>	213TTFW16036	✓	10:1	\$1,105	E9	91.7	7.5	157	22.22	6,24
10	3600	200	215TC		<b>U743</b>	215TTFW4013		2:1	\$1,012	E8	89.5	27.6	175	20.97	24
	3600	208-230/460	215TC	YES	<b>C392A</b>	215TTFW16005	✓	10:1	\$1,275	E8	91.7	26.4-23.6/11.8	139	22.22	6,24,68
	1800	200	215TC		<b>U718</b>	215TTFW4033		10:1	\$957	E8	89.5	29.9	128	20.97	24
	1800	208-230/460	215TC	YES	<b>C393A</b>	215TTFW16041	✓	10:1	\$1,215	E8	91.7	28.0-26.0/13.0	189	22.22	6,24,68
	1800	575	215TC	YES	<b>C394</b>	215TTFW4345		10:1	\$1,039	E8	89.5	10.4	191	20.97	6,24
	1800	575	215TC	YES	<b>C394A</b>	215TTFW16042		10:1	\$1,215	E8	91.7	10.3	208	22.22	6,24
15	1800	200	254TC		<b>U721</b>	254TTFW4033		10:1	\$1,436	E8	91.0	46.0	189	23.24	AL,24
	1800	575	254TC		<b>U723</b>	254TTFW4035		10:1	\$1,436	E8	91.0	16.0	236	23.24	AL,24

Catalog numbers (Cat No.) highlighted in bold blue have efficiency levels that meet EISA requirements

Blue shaded areas are Cast Iron Frames

\* Requires nameplate modification

### Brake Kits for

#### 56-143-145 frames ONLY (as noted)

TORQUE (LB-FT)	COIL VOLTAGE	CAT. NO.	STOCK	LIST (LOOSE)	LIST (INSTALLED)	MULT. SYMB.	WEIGHT
3	208-230/460	A301	✓	\$398	\$563	S4	10
	208-230/460	A1301	✓	\$398	\$563	S4	10
	575	A297	✓	\$398	\$563	S4	10
	575	A1297	✓	\$398	\$563	S4	3
6	208-230/460	A302	✓	\$469	\$632	S4	11
	208-230/460	A1302	✓	\$469	\$632	S4	10
	575	A298	✓	\$469	\$632	S4	11
10	208-230/460	A303	✓	\$580	\$737	S4	10
	208-230/460	A1303	✓	\$580	\$737	S4	10
	575	A299	✓	\$580	\$737	S4	10
	575	A1299	✓	\$580	\$737	S4	10

### Drip Cover Kits (Four-In-One)

CAT. NO.	STOCK	FRAME	LIST PRICE	MULT. SYMB.	WEIGHT
A234	✓	56-143T-145T	\$24	S4	2
A197	✓	182T-184T	\$27	S4	3
A199	✓	213T-215T	\$31	S4	5

GENERAL PURPOSE THREE PHASE

# NEMA Premium® XRI® Efficiency

## Three Phase, Totally Enclosed

### Applications:

General purpose use on compressors, pumps, conveyors, blowers, and other machinery in dirty and dusty environments. Substantial energy savings can be realized when using these high efficiency motors. Guaranteed efficiencies offer an eXtra Return on your Investment when using these premium efficiency motors on high cycle or long run time applications.

### Features:

- ⊕ Meets or exceeds NEMA Premium® efficiencies, except where noted NEMA Premium® models are in compliance with EISA2007
- Suitable for use on a VFD. Variable Torque and Constant Torque (as noted)
- 1.15 Service Factor on sinewave, 1.0 Service Factor on IGBT power
- F1 conduit box on Rigid Base, F3 on C-Face Footed (Rigid Base) motors
- Shaft slinger
- Class F insulation
- 1.15 Service Factor
- Ball bearings (except as noted)
- C-Face Footed models are rated 60/50 Hz, same HP
- Motors accept C-face kits, as noted
- UL Recognized, CSA Certified and CE Mark
- Three year warranty



Rigid Base



Models through 40 HP are capable of modification as follows (contact factory to confirm):

- 1.25 Service Factor (sinewave only)
- 50Hz at same HP, 1.0 Service Factor (sinewave only)
- Certain combinations of existing and new nameplate markings are not possible (contact factory to confirm)
- Any nameplate changes are subject to modification charges (see MOD Central section)
- Contact Marathon Motors for optional nameplate markings on 50 HP and larger



### Rigid Base

Suitable for use on VFD per guidelines on page 17.

HP	RPM	VOLTS	FRAME	CAT. NO.	MODEL NO.	STOCK	CT SPEED RANGE*	LIST PRICE	MULT. SYMB.	NOM. EFF.	F.L. AMPS	WEIGHT	"C" DIM.	FOOT NOTES	C FACE KITS
1	3600	200	56H	<b>E2150</b>	56T34F16001		10:1	\$540	E9	80.0	3.2	24	11.31		A665
	3600	230/460	56H	<b>E2100</b>	56T34F15940	✓	10:1	\$540	E9	80.0	2.8/1.4	24	11.31		A665
	3600	575	56H	<b>E2125</b>	56T34F16020		10:1	\$540	E9	80.0	1.1	24	11.31		A665
	1800	200	143T	<b>E2151</b>	143TTFR16038	✓	10:1	\$465	E9	85.5	3.7	32	13.75		A642
	1800	230/460	143T	<b>E2101</b>	143TTFR15642	✓	10:1	\$465	E9	85.5	3.2/1.6	32	13.75		A642
	1800	230/460	143T	<b>E2201-P</b>	143TTFN16040	✓	10:1	\$682	E9	85.5	3.0/1.5	48	13.99	P	A603
	1800	575	143T	<b>E2126</b>	143TTFR16040	✓	10:1	\$465	E9	85.5	1.3	32	13.75		A642
	1200	200	145T	<b>E2152</b>	145TTFR15581		10:1	\$555	E9	82.5	4.4	42	13.43		A642
	1200	230/460	145T	<b>E2102</b>	145TTFR16078	✓	10:1	\$555	E9	82.5	3.8/1.9	42	13.75		A642
	1200	575	145T	<b>E2127</b>	145TTFR16080		10:1	\$555	E9	82.5	1.5	42	13.75		A642
1 1/2	3600	200	143T	<b>E2153</b>	143TTFR16001		10:1	\$561	E9	84.0	4.6	37	13.75		A642
	3600	230/460	143T	<b>E2103</b>	143TTFR15582	✓	10:1	\$561	E9	84.0	4.0/2.0	37	13.75		A642
	3600	575	143T	<b>E2128</b>	143TTFR16020		10:1	\$561	E9	84.0	1.6	37	13.75		A642
	3600	230/460	143T	E351	143TTFN6001		20:1	\$655	E9	86.5	4.0/2.0	54	10.43	N,NE	A603
	1800	200	145T	<b>E2154</b>	145TTFR16038	✓	10:1	\$478	E9	86.5	5.5	34	13.75		A642
	1800	230/460	145T	<b>E2104</b>	145TTFR16033	✓	10:1	\$478	E9	86.5	4.8/2.4	34	13.75		A642
	1800	230/460	145T	<b>E2204-P</b>	145TTFN16046	✓	10:1	\$720	E9	86.5	4.6/2.3	54	13.99	P	A603
	1800	575	145T	<b>E2129</b>	145TTFR16040	✓	10:1	\$478	E9	86.5	1.9	34	13.75		A642
	1200	200	182T	<b>E2155</b>	182TTFW16082		10:1	\$710	E9	87.5	6.0	89	14.47	13	A666
	1200	230/460	182T	<b>E2105</b>	182TTFW16076	✓	10:1	\$710	E9	87.5	5.6/2.8	89	14.97	13	A666
	1200	575	182T	<b>E2130</b>	182TTFW16080		10:1	\$710	E9	87.5	2.2	89	14.47	13	A666

Catalog numbers (Cat No.) highlighted in bold blue have efficiency levels that meet EISA requirements

Blue shaded areas are Cast Iron Frames

\* Requires nameplate modification

GENERAL PURPOSE THREE PHASE

# NEMA Premium® XRI® Efficiency

## Three Phase, Totally Enclosed

### Rigid Base

HP	RPM	VOLTS	FRAME	CAT. NO.	MODEL NO.	STOCK	CT SPEED RANGE*	LIST PRICE	MULT. SYMB.	NOM. EFF.	F.L. AMPS	WEIGHT	"C" DIM.	FOOT NOTES	C FACE KITS	
2	3600	200	145T	<b>E2156</b>	145TTFR16001		10:1	\$578	E9	85.5	5.5	44	13.75		A642	
	3600	230/460	145T	<b>E2106</b>	145TTFR13002	✓	10:1	\$578	E9	85.5	4.8/2.4	44	13.75		A642	
	3600	575	145T	<b>E2131</b>	145TTFR16020		10:1	\$578	E9	85.5	1.9	44	13.75		A642	
	3600	230/460	145T	E353	145TTTN6001		20:1	\$642	E9	85.5	5.0/2.5	64	11.43	N,NE	A603	
	1800	200	145T	<b>E2157</b>	145TTFR16038	✓	10:1	\$525	E9	86.5	6.7	50	14.75		A642	
	1800	230/460	145T	<b>E2107</b>	145TTFR16035	✓	10:1	\$525	E9	86.5	5.8/2.9	50	14.75		A642	
	1800	230/460	145T	<b>E2207-P</b>	145TTFN16045	✓	10:1	\$684	E9	86.5	6.0/3.0	64	13.99	P	A603	
	1800	575	145T	<b>E2132</b>	145TTFR16045	✓	10:1	\$525	E9	86.5	2.3	50	14.75		A642	
	1200	200	184T	<b>E2158</b>	184TTFW16079		10:1	\$839	E9	88.7	7.4	89	14.97	13	A666	
	1200	230/460	184T	<b>E2108</b>	184TTFW16076	✓	10:1	\$839	E9	88.7	6.4/3.2	89	14.97	13	A666	
	1200	575	184T	<b>E2133</b>	184TTFW16081		10:1	\$839	E9	88.7	2.6	89	14.97	13	A666	
	1200	575	184T	<b>E002</b>	184TTFC6081	✓	10:1	\$899	E9	88.5	3.0	125	16.80	d	N/A	
	3	3600	200	182T	<b>E2159</b>	182TTFW16002	✓	10:1	\$777	E9	86.5	8.7	66	13.97	13	A666
		3600	230/460	182T	<b>E2109</b>	182TTFW16001	✓	10:1	\$777	E9	86.5	7.6/3.8	66	13.97	13	A666
3600		575	182T	<b>E2134</b>	182TTFW16020	✓	10:1	\$777	E9	86.5	3.0	66	13.97	13	A666	
3600		230/460	182T	E216	182TTTS6001		20:1	\$882	E9	89.5	7.6/3.8	94	12.71	N,NE	A644	
1800		200	182T	<b>E2160</b>	182TTFW16038	✓	10:1	\$693	E9	89.5	9.0	80	13.97	13	A666	
1800		230/460	182T	<b>E2110</b>	182TTFW16026	✓	10:1	\$693	E9	89.5	7.8/3.9	80	13.97	13	A666	
1800		230/460	182T	<b>E2210-P</b>	182TTFN16047	✓	10:1	\$909	E9	89.5	8.0/4.0	104	15.87	P	A644	
1800		575	182T	<b>E2135</b>	182TTFW16040	✓	10:1	\$693	E9	89.5	3.1	80	13.97	13	A666	
1800		575	182T	<b>U609A</b>	182TTFC6031	✓	10:1	\$747	E9	89.5	3.2	104	15.89	d	N/A	
1800		575	182T	E303	182TTTS6030		1000:1	\$791	E9	90.2	3.2	100	12.71	N,NE	A644	
1200		200	213T	<b>E2161</b>	213TTFW16082		10:1	\$1,026	E9	89.5	10.1	115	18.73		A609	
1200		230/460	213T	<b>E2111</b>	213TTFW16076	✓	10:1	\$1,026	E9	89.5	8.8/4.4	115	18.73		A609	
1200		575	213T	<b>E2136</b>	213TTFW16081		10:1	\$1,026	E9	89.5	3.5	115	18.73		A609	
5		3600	200	184T	<b>E2162</b>	184TTFW16002	✓	10:1	\$882	E9	88.5	13.8	96	16.47	13	A666
	3600	230/460	184T	<b>E2112</b>	184TTFW16001	✓	10:1	\$882	E9	88.5	12.0/6.0	96	16.47	13	A666	
	3600	575	184T	<b>E2137</b>	184TTFW16020	✓	10:1	\$882	E9	88.5	4.8	96	16.47	13	A666	
	3600	575	184T	<b>U615A</b>	184TTFC6006	✓	10:1	\$959	E9	88.5	5.2	112	16.52	d	N/A	
	1800	200	184T	<b>E2163</b>	184TTFW16038	✓	10:1	\$810	E9	89.5	14.7	94	14.97	13	A666	
	1800	230/460	184T	<b>E2113</b>	184TTFW16026	✓	10:1	\$810	E9	89.5	12.8/6.4	94	14.97	13	A666	
	1800	230/460	184T	<b>E202-P</b>	184TTFN16056	✓	10:1	\$1,003	E9	89.5	12.4/6.2	109	17.85	P	A644	
	1800	208-230/460	184T	<b>U618A</b>	184TTFC6027	✓	10:1	\$873	E9	89.5	14.0-12.8/6.4	109	16.80		N/A	
	1800	575	184T	<b>E2138</b>	184TTFW16040	✓	10:1	\$810	E9	89.5	5.1	94	14.97	13	A666	
	1800	575	184T	<b>U620A</b>	184TTFC6031	✓	10:1	\$873	E9	89.5	5.3	109	16.80	d	N/A	
	1200	200	215T	<b>E2164</b>	215TTFW16081		10:1	\$1,326	E9	90.2	16.1	135	20.23		A609	
	1200	230/460	215T	<b>E2114</b>	215TTFW16076	✓	10:1	\$1,326	E9	90.2	14.0/7.0	135	20.23		A609	
	1200	208-230/460	215T	<b>U621A</b>	215TTFC6077	✓	10:1	\$1,377	E9	90.2	15.8-14.4/7.2	176	19.61	d	N/A	
	1200	575	215T	<b>E2139</b>	215TTFW16080		10:1	\$1,326	E9	90.2	5.6	135	20.23		A609	
7 1/2	3600	230/460	213T	<b>E2115</b>	213TTFW16001	✓	10:1	\$1,066	E9	90.2	17.8/8.9	116	20.97		A609	
	3600	230/460	213T	E218	213TTTS6001		2:1	\$1,184	E9	90.2	17.8/8.9	185	15.69	N,NE	A206	
	3600	575	213T	<b>E2140</b>	213TTFW16020		10:1	\$1,066	E9	90.2	7.1	116	20.97		A609	
	3600	575	213T	<b>U671A</b>	213TTFC6006	✓	10:1	\$1,147	E9	90.2	7.3	147	18.19	d	N/A	
	1800	230/460	213T	<b>E2116</b>	213TTFW16026	✓	10:1	\$1,000	E9	91.7	21.6/10.8	144	18.70		A667	
	1800	230/460	213T	<b>E203-P</b>	213TTFN16326	✓	10:1	\$1,234	E9	91.7	20.1/10.0	185	19.63	P	A206	
	1800	208-230/460	213T	<b>U629A</b>	213TTFC6027	✓	10:1	\$1,074	E9	91.7	20.5-18.6/9.3	155	18.19		N/A	
	1800	575	213T	<b>E2141</b>	213TTFW16040	✓	10:1	\$1,000	E9	91.7	8.6	144	18.70		A667	
	1800	575	213T	<b>U631A</b>	213TTFC6031	✓	10:1	\$1,074	E9	91.7	8.9	155	18.19	d	N/A	
	1200	230/460	254T	<b>E2117</b>	254TTFL16076	✓	10:1	\$1,744	E9	91.0	19.8/9.9	162	23.40		A1209	
	1200	208-230/460	254T	<b>U633A</b>	254TTFC6077	✓	10:1	\$1,806	E9	91.0	24.2-22.2/11.1	249	23.19	d	N/A	
	1200	230/460	254T	<b>E235</b>	254TTFNA6076		20:1	\$1,872	E9	91.0	19.8/9.9	223	23.52		A284	
	1200	575	254T	<b>E2142</b>	254TTFL16077		10:1	\$1,744	E9	91.0	7.9	162	23.40		A1209	
	1200	575	254T	<b>E005</b>	254TTFC6081	✓	10:1	\$1,806	E9	91.0	8.5	249	23.19	d	N/A	

GENERAL PURPOSE THREE PHASE

Catalog numbers (Cat No.) highlighted in bold blue have efficiency levels that meet EISA requirements

Blue shaded areas are Cast Iron Frames

\* Requires nameplate modification

Continued on next page.

# NEMA Premium® XRI® Efficiency

## Three Phase, Totally Enclosed

### Rigid Base

HP	RPM	VOLTS	FRAME	CAT. NO.	MODEL NO.	STOCK	CT SPEED RANGE*	LIST PRICE	MULT. SYMB.	NOM. EFF.	F.L. AMPS	WEIGHT	"C" DIM.	FOOT NOTES	C FACE KITS
10	3600	230/460	215T	<b>E2118</b>	215TTFW16001	✓	10:1	\$1,176	E9	91.7	23.6/11.8	137	22.22		A609
	3600	208-230/460	215T	<b>U636A</b>	215TTFW6002	✓	10:1	\$1,286	E9	91.7	25.7-23.4/11.7	181	19.61	d	N/A
	3600	575	215T	<b>E2143</b>	215TTFW16020		10:1	\$1,176	E9	91.7	9.4	137	22.22		A609
	3600	575	215T	<b>U637A</b>	215TTFW6006	✓	10:1	\$1,286	E9	91.7	9.6	181	19.61	d	N/A
	1800	230/460	215T	<b>E2119</b>	215TTFW16026	✓	10:1	\$1,138	E9	91.7	26.8/13.4	161	19.70		A667
	1800	230/460	215T	<b>E204-P</b>	215TTFN16057	✓	10:1	\$1,475	E9	91.7	25.0/12.5	177	22.63	P	A206
	1800	208-230/460	215T	<b>U639A</b>	215TTFW6027	✓	10:1	\$1,190	E9	91.7	27.5-25.0/12.5	177	19.61		N/A
	1800	575	215T	<b>E2144</b>	215TTFW16040	✓	10:1	\$1,138	E9	91.7	10.7	161	19.70		A667
	1800	575	215T	<b>U641A</b>	215TTFW6031	✓	10:1	\$1,190	E9	91.7	10.3	177	19.61	d	N/A
	1800	575	215T	<b>E306</b>	215TTFW6030		20:1	\$1,353	E9	91.7	10.0	225	19.70		A206
	1200	230/460	256T	<b>E2120</b>	256TTFW16076	✓	10:1	\$2,153	E9	91.0	26.2/13.1	185	25.15		A1209
	1200	208-230/460	256T	<b>U642A</b>	256TTFW6077	✓	10:1	\$2,244	E9	91.0	32.4-29.9/14.5	300	24.92	d	N/A
15	3600	230/460	254T	<b>E2121</b>	254TTFW16001	✓	10:1	\$1,672	E9	91.0	35.4/17.7	162	22.99		A1209
	3600	208-230/460	254T	<b>U644A</b>	254TTFW6002	✓	10:1	\$1,719	E9	91.0	38.5-35.0/17.5	200	19.61	d	N/A
	3600	230/460	254T	<b>E220</b>	254TTFNA6001		2:1	\$1,815	E9	91.7	35.0/17.5	350	23.52		A284
	3600	575	254T	<b>E2146</b>	254TTFW16020		10:1	\$1,672	E9	91.0	14.2	162	22.99		A1209
	3600	575	254T	<b>U638A</b>	254TTFW6006	✓	10:1	\$1,719	E9	91.0	14.3	200	19.61	d	N/A
	1800	230/460	254T	<b>E2122</b>	254TTFW16026	✓	10:1	\$1,554	E9	92.4	38.1/19.1	174	22.99		A1209
	1800	230/460	254T	<b>E2122-P</b>	254TTFW16036	✓	10:1	\$1,639	E9	92.4	38.1/19.1	174	22.99	P	A1209
	1800	208-230/460	254T	<b>U647B</b>	254TTFW6027	✓	10:1	\$1,640	E9	92.4	39.6-36.0/18.0	280	23.19		N/A
	1800	230/460	254T	<b>E205</b>	254TTFNA6026		20:1	\$1,704	E9	92.4	37.6/18.8	350	23.52		A284
	1800	230/460	254T	<b>E205-P</b>	254TTFNA6026	✓	20:1	\$1,955	E9	92.4	37.6/18.8	350	23.52	P	A284
	1800	575	254T	<b>E2147</b>	254TTFW16040	✓	10:1	\$1,554	E9	92.4	15.8	174	22.99		A1209
	1800	575	254T	<b>U648A</b>	254TTFW6031	✓	10:1	\$1,640	E9	92.4	15.6	280	23.19	d	N/A
20	3600	230/460	284T	<b>E307</b>	254TTFNA6030		20:1	\$1,704	E9	92.4	15.1	350	23.52		A284
	1200	230/460	284T	<b>E237</b>	284TTFW6076	✓	20:1	\$3,035	E9	91.7	40.8/20.4	475	26.34		A618
	1200	208-230/460	284T	<b>E978A</b>	284TTFW6077	✓	10:1	\$3,035	E9	91.7	44.7-40.6/20.3	333	26.26		N/A
	3600	230/460	256T	<b>E2123</b>	256TTFW16002	✓	10:1	\$2,249	E9	91.0	47.0/23.5	186	24.74		A1209
	3600	208-230/460	256T	<b>U649A</b>	256TTFW6002	✓	10:1	\$2,351	E9	91.0	50.6-46.0/23.0	316	24.92	d	N/A
	3600	230/460	256T	<b>E221</b>	256TTFNA6001		2:1	\$2,351	E9	92.4	46.8/23.4	375	25.27		A284
	3600	575	256T	<b>E2148</b>	256TTFW16020		10:1	\$2,249	E9	91.0	18.9	186	26.24		A1209
	1800	230/460	256T	<b>E2124</b>	256TTFW16033	✓	10:1	\$1,935	E9	93.0	48.6/24.3	191	26.24		A1209
	1800	230/460	256T	<b>E2124-P</b>	256TTFW16038	✓	10:1	\$2,041	E9	93.0	48.6/24.3	191	26.24	P	A1209
	1800	208-230/460	256T	<b>U652B</b>	256TTFW6027	✓	10:1	\$2,044	E9	93.0	53.9-49.0/24.5	322	24.92		N/A
	1800	230/460	256T	<b>E206</b>	256TTFNA6026	✓	20:1	\$2,123	E9	93.0	48.2/24.1	425	25.27	d	A284
	1800	230/460	256T	<b>E206-P</b>	256TTFNA16070	✓	20:1	\$2,441	E9	93.0	48.2/24.1	425	25.27	P	A284
25	1800	575	256T	<b>E2149</b>	256TTFW16040	✓	10:1	\$1,935	E9	93.0	20.4	191	26.24		A1209
	1800	575	256T	<b>U653A</b>	256TTFW6031	✓	10:1	\$2,044	E9	93.0	20.2	322	24.92	d	N/A
	1800	575	256T	<b>E308</b>	256TTFNA6030		20:1	\$2,123	E9	93.0	19.3	425	25.27		A284
	1200	230/460	286T	<b>E238</b>	286TTFW6076	✓	20:1	\$3,698	E9	91.7	53.6/26.8	550	27.84		A618
	1200	208-230/460	286T	<b>E968A</b>	286TTFW6077	✓	10:1	\$3,698	E9	91.7	59.4-54.0/27.0	392	27.83	d	N/A
	1200	575	286T	<b>E008</b>	286TTFW6081	✓	10:1	\$3,698	E9	91.7	45.4	550	27.84	d	N/A
	3600	230/460	284TS	<b>E222</b>	284TSTFNA6001	✓	2:1	\$2,771	E9	93.6	56.2/28.1	475	24.97		A618
	3600	208-230/460	284TS	<b>E975A</b>	284TSTFC6002	✓	10:1	\$2,771	E9	91.7	62.3-56.8/28.4	383	24.88	d	N/A
	1800	230/460	284T	<b>E207</b>	284TTFNA6026	✓	20:1	\$2,528	E9	93.6	62.0/31.0	500	26.34		A618
	1800	230/460	284T	<b>E207-P</b>	284TTFNA16070	✓	20:1	\$2,898	E9	93.6	62.0/31.0	500	26.34	P	A618
	1800	208-230/460	284T	<b>E961C</b>	284TTFW6027	✓	10:1	\$2,528	E9	93.6	64.9-59.0/29.5	385	26.26	d	N/A
	1800	208-230/460	284TS	<b>E999A</b>	284TSTFC6036	✓	10:1	\$2,528	E9	93.6	64.9-59.0/29.5	385	26.26		N/A
1800	575	284T	<b>E309</b>	284TTFNA6030	✓	20:1	\$2,528	E9	93.6	24.8	500	26.34		A618	
1800	575	284T	<b>E800A</b>	284TTFW6031	✓	10:1	\$2,528	E9	93.6	23.6	385	26.26	d	N/A	
1200	230/460	324T	<b>E239</b>	324TTFW6076	✓	20:1	\$4,482	E9	93.0	65.0/32.5	675	28.87		A214	
30	3600	230/460	286TS	<b>E223</b>	286TSTFNA6001	✓	2:1	\$3,236	E9	93.6	67.6/33.8	500	26.47		A618
	1800	230/460	286T	<b>E208</b>	286TTFNA6026	✓	20:1	\$2,940	E9	94.1	73.0/36.5	525	27.84		A618
	1800	230/460	286T	<b>E208-P</b>	286TTFNA16328	✓	20:1	\$3,380	E9	94.1	73.0/36.5	525	27.84	P	A618
	1800	208-230/460	286T	<b>E983B</b>	286TTFW6027	✓	10:1	\$2,940	E9	93.6	77.070.0/35.0	432	27.83		N/A
	1800	208-230/460	286TS	<b>E818A</b>	286TSTFC6036	✓	10:1	\$2,940	E9	93.6	77.070.0/35.0	432	27.83		N/A
	1800	575	286T	<b>E310</b>	286TTFNA6030	✓	20:1	\$2,940	E9	94.1	29.2	525	27.84		A618

GENERAL PURPOSE THREE PHASE

Catalog numbers (Cat No.) highlighted in bold blue have efficiency levels that meet EISA requirements

Blue shaded areas are Cast Iron Frames

\* Requires nameplate modification

@ Requires larger fan

Continued on next page.

# NEMA Premium® XRI® Efficiency

## Three Phase, Totally Enclosed

### Rigid Base

HP	RPM	VOLTS	FRAME	CAT. NO.	MODEL NO.	STOCK	CT SPEED RANGE*	LIST PRICE	MULT. SYMB.	NOM. EFF.	F.L. AMPS	WEIGHT	"C" DIM.	FOOT NOTES	C FACE KITS
30	1800	575	286T	<b>E817A</b>	286TTFC6031	✓	10:1	\$2,940	E9	93.6	29.7	432	27.83		N/A
	1200	230/460	326T	<b>E240</b>	326TTFS6076	✓	20:1	\$5,162	E9	93.0	77.0/38.5	725	30.37		A214
	1200	208-230/460	326T	<b>E966A</b>	326TTFC6077	✓	10:1	\$5,162	E9	93.0	84.9-77.2/38.6	615	31.02	d	N/A
	1200	575	326T	<b>E010</b>	326TTFC6081	✓	10:1	\$5,162	E9	93.0	32.4	615	31.02	d	N/A
40	3600	230/460	324TS	<b>E224</b>	324TSTFS6001	✓	2:1	\$4,267	E9	93.6	94.0/47.0	675	27.37		A214
	3600	208-230/460	324TS	<b>E971A</b>	324TSTFC6002	✓	10:1	\$4,267	E9	92.4	97.9-89.0/44.5	504	28.03		N/A
	3600	575	324TS	<b>E319</b>	324TSTFS6005		2:1	\$4,267	E9	94.1	37.5	675	27.37		A214
	3600	575	324TS	<b>E011</b>	324TSTFC6006	✓	10:1	\$4,267	E9	92.4	35.4	504	28.03		N/A
	1800	230/460	324T	<b>E209</b>	324TTFS6026	✓	20:1	\$3,905	E9	94.1	95.0/47.5	528	30.37		A214
	1800	230/460	324T	<b>E209-P</b>	324TTFS16066	✓	20:1	\$4,504	E9	94.1	95.0/47.5	528	30.37	P	A214
	1800	208-230/460	324T	<b>E984B</b>	324TTFC6027	✓	10:1	\$3,905	E9	94.1	101-92.0/46.0	598	29.53	d	N/A
	1800	208-230/460	324TS	<b>E816A</b>	324TSTFC6036	✓	10:1	\$3,905	E9	94.1	101-92.0/46.0	598	29.53		N/A
	1800	575	324T	<b>E311</b>	324TTFS6030	✓	20:1	\$3,905	E9	94.1	39.0	528	30.37		A214
	1800	575	324T	<b>E815A</b>	324TTFC6031	✓	10:1	\$3,905	E9	94.1	37.8	598	29.53	d	N/A
	1200	230/460	364T	<b>E241A</b>	364TTFS16083	✓	20:1@	\$7,637	E9	94.1	100/50.0	950	31.50		A395
	50	1200	208-230/460	364T	<b>E988A</b>	364TTFC6087	✓	10:1	\$7,637	E9	94.1	112-102/51.0	636	32.64	d
1200		575	364T	<b>E012</b>	364TTFC6081	✓	10:1	\$7,637	E9	94.1	42.8	636	32.64	d	N/A
3600		230/460	326TS	<b>E225</b>	326TSTFS6001	✓	2:1	\$5,520	E9	93.6	116/58.0	725	28.87		A214
3600		208-230/460	326TS	<b>E976A</b>	326TSTFC6002	✓	10:1	\$5,520	E9	93.0	122-111/55.5	554	29.53	d	N/A
3600		575	326TS	<b>E320</b>	326TSTFS6005		2:1	\$5,520	E9	94.5	46.5	725	28.87		A214
3600		575	326TS	<b>E013</b>	326TSTFC6006	✓	10:1	\$5,520	E9	93.0	44.5	554	29.53		N/A
1800		230/460	326T	<b>E210</b>	326TTFS6026	✓	20:1@	\$4,796	E9	94.5	120/60.0	775	31.87		A214
1800		230/460	326T	<b>E210-P</b>	326TTFS16073	✓	20:1@	\$5,515	E9	94.5	120/60.0	775	31.87	P	A214
1800		208-230/460	326T	<b>E962B</b>	326TTFC6027	✓	10:1	\$4,796	E9	94.5	129-117/58.5	681	31.02	d	N/A
1800		208-230/460	326TS	<b>E801A</b>	326TSTFC6036	✓	10:1	\$4,796	E9	94.5	129-117/58.5	681	29.53		N/A
1800		575	326T	<b>E312</b>	326TTFS6030	✓	20:1@	\$4,796	E9	94.5	48.0	775	31.87		A214
1800		575	326T	<b>U659A</b>	326TTFC6031	✓	10:1	\$4,796	E9	94.5	47.9	681	31.02	d	N/A
60	1200	230/460	365T	<b>E242A</b>	365TTFS16083	✓	20:1@	\$8,569	E9	94.1	123/61.5	1000	32.50		A395
	1200	208-230/460	365T	<b>E993A</b>	365TTFC6087	✓	10:1	\$8,569	E9	94.1	136-124/62	672	33.62	d	N/A
	1200	575	365T	<b>E014</b>	365TTFC6081	✓	10:1	\$8,569	E9	94.1	52.1	672	33.62	d	N/A
	3600	230/460	364TS	<b>E226</b>	364TSTFS6001	✓	2:1	\$7,263	E9	94.5	134/67.0	925	29.38		A396
	3600	208-230/460	364TS	<b>E960A</b>	364TSTFC6002	✓	10:1	\$7,263	E9	93.6	149-136/68.0	735	30.51	d	N/A
	3600	575	364TS	<b>E321</b>	364TSTFS6005		2:1	\$7,263	E9	94.5	53.5	925	29.38		A396
	3600	575	364TS	<b>E015</b>	364TSTFC6006	✓	10:1	\$7,263	E9	93.6	53.7	735	30.51	d	N/A
	1800	230/460	364T	<b>E211</b>	364TTFS6036	✓	20:1@	\$6,880	E9	95.0	138/69.0	1000	31.50		A395
	1800	208-230/460	364T	<b>E985B</b>	364TTFC6037	✓	10:1	\$6,880	E9	95.4	151-139/69.5	947	32.64	d	N/A
	1800	208-230/460	364TS	<b>E802A</b>	364TSTFC6026	✓	10:1	\$6,880	E9	95.4	151-139/69.5	947	32.64		N/A
	1800	575	364T	<b>E313</b>	364TTFS6040	✓	20:1@	\$6,880	E9	95.0	55.0	1000	31.50		A395
	1800	575	364T	<b>U660A</b>	364TTFC6041	✓	10:1	\$6,880	E9	95.0	55.6	947	32.64	d	N/A
75	1200	230/460	404T	<b>E243</b>	404TTFS6086	✓	20:1@	\$9,414	E9	94.5	144/72.0	1200	35.62		A223
	3600	230/460	365TS	<b>E227</b>	365TSTFS6001	✓	2:1	\$9,120	E9	94.5	168/84.0	1025	30.38		A396
	3600	208-230/460	365TS	<b>E991A</b>	365TSTFC6003	✓	10:1	\$9,120	E9	93.6	186-169/84.5	780	31.50	d	N/A
	3600	575	365TS	<b>E322</b>	365TSTFS6002		2:1	\$9,120	E9	94.5	67.0	1025	30.38		A396
	3600	575	365TS	<b>E016</b>	365TSTFC6006	✓	10:1	\$9,120	E9	93.6	67.3	780	31.50	d	N/A
	1800	230/460	365T	<b>E212</b>	365TTFS6036	✓	20:1@	\$8,722	E9	95.4	172/86.0	1100	32.50		A395
	1800	208-230/460	365T	<b>E957A</b>	365TTFC6037	✓	10:1	\$8,722	E9	95.8	188-171/85.5	1014	33.62	d	N/A
	1800	208-230/460	365TS	<b>E804A</b>	365TSTFC6026	✓	10:1	\$8,722	E9	95.8	188-171/85.5	1014	33.62		N/A
	1800	575	365T	<b>E315</b>	365TTFS6040	✓	20:1@	\$8,722	E9	95.4	69.0	1100	32.50		A395
	1800	575	365T	<b>E805A</b>	365TTFC6041	✓	10:1	\$8,722	E9	95.4	71.0	733	33.62	d	N/A
	1200	230/460	405T	<b>E244</b>	405TTFS6086	✓	20:1@	\$11,081	E9	94.5	180/90	1300	37.12		A223
	100	3600	230/460	405TS	<b>E228</b>	405TSTFS6001	✓	2:1	\$12,220	E9	95.0	216/108	1250	34.13	
3600		575	405TS	<b>E323</b>	405TSTFS6005		2:1	\$12,220	E9	95.0	86.5	1250	34.13		A226
1800		230/460	405T	<b>E213</b>	405TTFS6036	✓	20:1@	\$10,776	E9	95.4	226/113	1220	37.12		A223
1800		230/460	405TS	<b>E808A</b>	405TSTFS16033	✓	20:1@	\$10,776	E9	95.4	226/113	1220	34.13		A226
1800		575	405T	<b>E314</b>	405TTFS6040	✓	20:1@	\$10,776	E9	95.4	90.5	1220	37.12		A223
1200		230/460	444T	<b>E328</b>	444TTFN6086	✓	20:1@	\$16,341	E9	95.0	248/124	2000	41.25		A620

Catalog numbers (Cat No.) highlighted in bold blue have efficiency levels that meet EISA requirements

Blue shaded areas are Cast Iron Frames

\* Requires nameplate modification  
@ Requires larger fan

Continued on next page.

# NEMA Premium® XRI® Efficiency

## Three Phase, Totally Enclosed

### Rigid Base

HP	RPM	VOLTS	FRAME	CAT. NO.	MODEL NO.	STOCK	CT SPEED RANGE*	LIST PRICE	MULT. SYMB.	NOM. EFF.	F.L. AMPS	WEIGHT	"C" DIM.	FOOT NOTES	C FACE KITS
125	3600	460	444TS	<b>E229</b>	444TSTFS6001	√	2:1	\$15,975	E9	95.4	136	1750	37.50	PW	N/A
	3600	575	444TS	<b>E324</b>	444TSTFS16002		2:1	\$15,975	E9	95.4	109	1750	37.50	PW	A232
	1800	460	444T	<b>E214</b>	444TTFS6036	√	20:1@	\$14,186	E9	95.4	141	1850	41.25	PW	A229
	1800	460	444TS	<b>E810A</b>	444TSTFN16033	√	20:1@	\$14,186	E9	95.4	141	1850	37.50		A621
	1800	575	444T	<b>E316A</b>	444TTFN6044		20:1@	\$14,186	E9	95.4	117	1752	43.35	PW	A620
	1200	460	445T	<b>E246</b>	445TTFN6086	√	20:1@	\$18,603	E9	95.0	155	2050	43.19		A620
150	3600	460	445TS	<b>E230</b>	445TSTFN6001	√	2:1	\$19,191	E9	95.8	165	2050	39.44		A621
	1800	460	445T	<b>E215</b>	445TTFN6036	√	20:1@	\$16,493	E9	95.8	172	2050	43.19		A620
	1800	460	445TS	<b>E811A</b>	445TSTFN6026	√	20:1@	\$16,493	E9	95.8	172	2050	39.60	68	A621
	1800	575	445T	<b>E317</b>	445TTFN6037		20:1@	\$16,493	E9	95.8	138	2050	43.19	PW	A620
	1200	460	445T	<b>E289</b>	445TTFN6087		20:1@	\$20,813	E9	95.8	181	2500	43.19	RB	N/A
	200	3600	460	445TS	<b>E342</b>	445TSTFN16004	√	2:1	\$24,277	E9	95.8	222	2300	39.44	
1800		460	445T	<b>E247</b>	445TTFN6038	√	20:1@	\$20,058	E9	96.2	226	2350	43.19	RB	N/A
1800		460	445T	<b>U669A</b>	445TTFN6028		20:1@	\$20,058	E9	96.2	226	2350	43.35		A620
1800		460	445TS	<b>E813A</b>	445TSTFN16033	√	20:1@	\$20,058	E9	96.2	226	2350	39.60		A621
1800		575	445T	<b>E326</b>	445TTFN6039		20:1@	\$20,058	E9	96.2	181	2350	43.19	RB	N/A
1200		460	447/9T	<b>E282</b>	449TTFS6088	√	20:1@	\$25,479	E9	95.8	240	2900	51.69	H, RB	N/A
1200		460	447/9T	<b>E814A</b>	449TTFS16094	√	20:1@	\$25,479	E9	95.8	240	2746	51.86	H, RB	N/A
250		3600	460	447/9TS	<b>E271</b>	449TSTFS6003		2:1	\$30,617	E9	96.5	274	2700	47.88	H
	1800	460	445T	<b>E287</b>	445TTFN6040		20:1@	\$23,645	E9	95.8	285	2150	43.35	RB, X	N/A
	1800	460	447/9T	<b>E276</b>	449TTFS6038		20:1@	\$25,419	E9	96.5	285	2850	51.69	H, RB	N/A
	1200	460	L447/9T	<b>E283</b>	449TTFS6087		20:1@	\$29,288	E9	95.8	300	3350	51.69	H, RB	N/A
300	3600	460	447/9TS	<b>E272</b>	449TSTFS6002		2:1	\$39,686	E9	96.2	330	2700	47.88	H	A624
	1800	460	447/9T	<b>E277</b>	449TTFS6037		20:1@	\$28,756	E9	96.5	339	3150	51.69	H, RB	N/A
	1200	460	L447/9T	<b>E284</b>	449TTFS6390		N/A	\$38,669	E9	95.8	362	3850	56.71	H, RB	N/A
350	3600	460	447/9TS	<b>E273</b>	449TSTFS6001		2:1	\$45,511	E9	96.2	382	2950	47.88		A624
	1800	460	447/9T	<b>E293</b>	449TTFS16333		2:1	\$37,524	E9	96.2	395	3400	51.88	H, RB	N/A
400	1800	460	447/9T	<b>E291</b>	449TTFS16334		2:1	\$37,865	E9	96.5	460	3800	56.71	H	A623
450	1800	460	L447/9T	<b>E292</b>	449TTFS6065		N/A	\$38,822	E9	96.5	515	3800	56.71	H	A623

\* Requires nameplate modification

@ Requires larger fan

### C-Face Footed (Rigid Base)

HP	RPM	VOLTS	FRAME	CAT. NO.	MODEL NO.	STOCK	CT SPEED RANGE	LIST PRICE	MULT. SYMB.	NOM. EFF.	F.L. AMPS	WEIGHT	"C" DIM.	FOOT NOTES
1	3600	208-230/460	56C	<b>E2000</b>	056T34F5940	√	10:1	\$592	E9	80.0	3.0-2.8/1.4	28	11.31	
	1800	208-230/460	143TC	<b>E2001</b>	143TTFR5642	√	10:1	\$476	E9	85.5	3.2-3.2/1.6	40	13.75	d
	1800	230/460	143TC	<b>E2001A</b>	143TTFR16053	√	10:1	\$502	E9	85.5	3.2/1.6	32	13.75	P
	1200	208-230/460	145TC	<b>E2002</b>	145TTFR6078	√	10:1	\$573	E9	82.5	3.8-3.8/1.9	45	13.75	
1 1/2	3600	208-230/460	143TC	<b>E2003</b>	143TTFR5582	√	10:1	\$551	E9	84.0	4.4-4.0/2.0	38	13.75	
	1800	208-230/460	145TC	<b>E2004</b>	145TTFR6033	√	10:1	\$518	E9	86.5	5.2-4.8/2.4	45	13.75	d
	1800	230/460	145TC	<b>E2004A</b>	145TTFR16331	√	10:1	\$546	E9	86.5	4.8/2.4	34	13.75	P
2	1200	208-230/460	182TC	<b>E2005</b>	182TTFW6076	√	10:1	\$749	E9	87.5	6.0-5.1/2.6	82	14.47	13
	3600	208-230/460	145TC	<b>E2006</b>	145TTFR3002	√	10:1	\$610	E9	85.5	5.2-4.8/2.4	48	13.75	
	1800	208-230/460	145TC	<b>E2007</b>	145TTFR6035	√	10:1	\$568	E9	86.5	6.0-5.8/2.9	50	14.25	d
	1800	230/460	145TC	<b>E2007A</b>	145TTFR16329	√	10:1	\$599	E9	86.5	5.8/2.9	50	14.25	P
3	1200	208-230/460	184TC	<b>E2008</b>	184TTFW6076	√	10:1	\$858	E9	88.5	7.4-6.4/3.2	94	14.97	13
	3600	208-230/460	182TC	<b>E2009</b>	182TTFW6001	√	10:1	\$791	E9	87.5	8.4-7.8/3.9	81	13.97	13
	1800	208-230/460	182TC	<b>E2010</b>	182TTFW6026	√	10:1	\$749	E9	89.5	8.4-7.8/3.9	87	13.97	13,P
5	1200	208-230/460	213TC	<b>E2011</b>	213TTFW6076	√	10:1	\$1,047	E9	89.5	9.2-8.8/4.4	125	19.47	
	3600	208-230/460	184TC	<b>E2012</b>	184TTFW6001	√	10:1	\$917	E9	88.5	13.0-12.0/6.0	85	17.19	13
	1800	208-230/460	184TC	<b>E2013</b>	184TTFW6026	√	10:1	\$874	E9	90.2	13.7-12.6/6.3	87	14.97	13,P
7 1/2	1200	208-230/460	215TC	<b>E2014</b>	215TTFW6076	√	10:1	\$1,348	E9	90.2	15.0-14.0/7.0	160	20.97	
	3600	208-230/460	213TC	<b>E2015</b>	213TTFW6001	√	10:1	\$1,127	E9	91.7	19.7-17.8/8.9	116	20.97	
	1800	208-230/460	213TC	<b>E2016</b>	213TTFW6026	√	10:1	\$1,023	E9	91.7	21.0-19.4/9.7	143	20.97	d
10	1800	230/460	213TC	<b>E2016A</b>	213TTFW16039	√	10:1	\$1,079	E9	91.7	19.4/9.7	143	20.97	P
	3600	208-230/460	215TC	<b>E2018</b>	215TTFW6001	√	10:1	\$1,199	E9	91.7	26.4-23.6/11.8	230	22.22	
	1800	208-230/460	215TC	<b>E2019</b>	215TTFW6026	√	10:1	\$1,164	E9	91.7	28.0-25.6/12.8	164	22.22	d
	1800	230/460	215TC	<b>E2019A</b>	215TTFW16047	√	10:1	\$1,228	E9	91.7	25.6/12.8	164	22.22	P

Catalog numbers (Cat No.) highlighted in bold blue have efficiency levels that meet EISA requirements

Blue shaded areas are Cast Iron Frames

GENERAL PURPOSE THREE PHASE

# General Purpose, Three Phase Globetrotter® NEMA Premium® Efficiency Totally Enclosed

Features:

☑ Meets or exceeds NEMA Premium® efficiencies

NEMA Premium® models are in compliance with EISA2007

- Cast iron frame and brackets
- Inverter Duty 10:1 Variable Torque and 10:1 Constant Torque, 1.0 SF
- 1.15 Service Factor
- Class F Insulation
- Standard assembly F1, reversible to F2 assembly
- UL Recognized, CSA Certified, CE Mark
- Three year warranty



## Rigid Base

HP	RPM	VOLTS	FRAME	CAT. NO.	MODEL NO.	STOCK	LIST PRICE	MULT. SYMB.	NOM. EFF.	F.L. AMPS	APPROX WGT. LBS	"C" DIM.	FOOT NOTES	C FACE KITS
1 1/2	1200	208-230/460	182T	<b>GT1005</b>	182TTFC6076	✓	\$697	E1	87.5	4.8/2.4	89	14.80	75	A644
	1200	575	182T	<b>GT1105</b>	182TTFC6080	✓	\$697	E1	87.5	1.9	89	14.80	75	A644
2	1200	230/460	184T	<b>GT1008</b>	184TTFC6076	✓	\$824	E1	88.5	6.0/3.0	125	15.81	75	A644
	1200	575	184T	<b>GT1108</b>	184TTFC6080	✓	\$824	E1	88.5	2.4	125	15.81	75	A644
3	3600	208-230/460	182T	<b>GT1009</b>	182TTFC6001	✓	\$866	E1	86.5	7.6/3.8	94	14.80	A, 75	A644
	3600	575	182T	<b>GT1109</b>	182TTFC6005	✓	\$866	E1	86.5	3.1	94	14.80	75	A644
	1800	208-230/460	182T	<b>GT1010</b>	182TTFC6026	✓	\$777	E1	89.5	7.8/3.9	102	14.80	75	A644
	1800	575	182T	<b>GT1110</b>	182TTFC6030	✓	\$777	E1	89.5	3.1	102	14.80	75	A644
	1200	208-230/460	213T	<b>GT1011</b>	213TTFC6076	✓	\$1,178	E1	89.5	8.6/4.3	173	18.23	75	A206
	1200	575	213T	<b>GT1111</b>	213TTFC6080	✓	\$1,178	E1	89.5	3.5	173	18.23	75	A206
5	3600	208-230/460	184T	<b>GT1012</b>	184TTFC6001	✓	\$963	E1	88.5	12.0/6.0	109	15.81	A, 75	A644
	3600	575	184T	<b>GT1112</b>	184TTFC6005	✓	\$963	E1	88.5	4.8	109	15.81	75	A644
	1800	208-230/460	184T	<b>GT1013</b>	184TTFC6026	✓	\$901	E1	90.2	12.4/6.2	117	15.81	A, 75	A644
	1800	575	184T	<b>GT1113</b>	184TTFC6030	✓	\$901	E1	89.5	5.0	117	15.81	75	A644
	1200	208-230/460	215T	<b>GT1014</b>	215TTFC6076	✓	\$1,447	E1	90.2	14/7.0	203	19.73	75	A206
	1200	575	215T	<b>GT1114</b>	215TTFC6080	✓	\$1,447	E1	89.5	5.6	203	19.73	75	A206
7 1/2	3600	208-230/460	213T	<b>GT1015</b>	213TTFC6001	✓	\$1,163	E1	89.5	17.8/8.9	185	18.23	A, 75	A206
	3600	575	213T	<b>GT1115</b>	213TTFC6005	✓	\$1,163	E1	89.5	7.1	185	18.23	75	A206
	1800	208-230/460	213T	<b>GT1016</b>	213TTFC6026	✓	\$1,104	E1	91.7	18.6/9.3	194	18.23	75	A206
	1800	575	213T	<b>GT1116</b>	213TTFC6030	✓	\$1,104	E1	91.7	7.5	194	18.23	75	A206
	1200	208-230/460	254T	<b>GT1017</b>	254TTFCA6076	✓	\$1,839	E1	91.0	20.4/10.2	223	23.70	75	A173
	1200	575	254T	<b>GT1117</b>	254TTFCA6080	✓	\$1,839	E1	91.0	8.4	223	26.60	75	A173
10	3600	208-230/460	215T	<b>GT1018</b>	215TTFC6001	✓	\$1,358	E1	90.2	22.8/11.4	217	19.73	75	A206
	3600	575	215T	<b>GT1118</b>	215TTFC6005	✓	\$1,358	E1	90.2	9.1	217	19.73	75	A206
	1800	208-230/460	215T	<b>GT1019</b>	215TTFC6026	✓	\$1,329	E1	91.7	24.4/12.2	225	19.73	75	A206
	1800	575	215T	<b>GT1119</b>	215TTFC6030	✓	\$1,329	E1	91.7	9.8	225	19.73	75	A206
	1200	208-230/460	256T	<b>GT1020</b>	256TTFCA6076	✓	\$2,246	E1	91.0	26.8/13.4	368	25.43	75	A173
	1200	575	256T	<b>GT1120</b>	256TTFCA6080	✓	\$2,246	E1	91.0	11.2	368	27.80	75	A173
15	3600	208-230/460	254T	<b>GT1021</b>	254TTFCA6001	✓	\$1,783	E1	91.0	34/17.0	350	23.70	75	A172
	3600	575	254T	<b>GT1121</b>	254TTFCA6005	✓	\$1,783	E1	91.0	13.6	350	26.60	75	A172
	1800	208-230/460	254T	<b>GT1022</b>	254TTFCA6026	✓	\$1,674	E1	92.4	37/18.5	375	23.70	75	A173
	1800	575	254T	<b>GT1122</b>	254TTFCA6030	✓	\$1,674	E1	92.4	14.8	375	26.60	75	A173
	1200	208-230/460	284T	<b>GT1023</b>	284TTFCA6076	✓	\$2,981	E1	91.7	39.5/19.8	475	27.83	75	A175
	1200	575	284T	<b>GT1123</b>	284TTFCA6080	✓	\$2,981	E1	91.7	15.9	475	30.16	75	A175

Catalog numbers (Cat No.) highlighted in bold blue have efficiency levels that meet EISA requirements

Blue shaded areas are Cast Iron Frames

Continued on next page.

# General Purpose, Three Phase Globetrotter® NEMA Premium® Efficiency Totally Enclosed

## Rigid Base

HP	RPM	VOLTS	FRAME	CAT. NO.	MODEL NO.	STOCK	LIST PRICE	MULT. SYMB.	NOM. EFF.	F.L. AMPS	APPROX WGT. LBS	"C" DIM.	FOOT NOTES	C FACE KITS
20	3600	208-230/460	256T	<b>GT1024</b>	256TTFCA6001	✓	\$2,209	E1	91.0	46.0/23.0	375	27.80	75	A172
	3600	575	256T	<b>GT1124</b>	256TTFCA6005	✓	\$2,209	E1	91.0	18.4	375	27.80	75	A172
	1800	208-230/460	256T	<b>GT1025</b>	256TTFCA6026	✓	\$2,085	E1	93.0	48.0/24.0	425	27.80	75	A173
	1800	575	256T	<b>GT1125</b>	256TTFCA6030	✓	\$2,085	E1	93.0	19.6	425	27.80	75	A173
	1200	208-230/460	286T	<b>GT1026</b>	286TTFCA6076	✓	\$3,632	E1	91.7	52.0/26.0	550	31.34		A175
	1200	575	286T	<b>GT1126</b>	286TTFCA6080	✓	\$3,632	E1	91.7	20.8	550	31.34		A175
25	3600	208-230/460	284TS	<b>GT1027</b>	284TSTFCA6001	✓	\$2,722	E1	91.7	55.5/27.7	475	28.82		A174
	3600	575	284TS	<b>GT1127</b>	284TSTFCA6005	✓	\$2,722	E1	91.7	22.4	475	28.82		A174
	1800	208-230/460	284T	<b>GT1028</b>	284TTFCA6026	✓	\$2,483	E1	93.6	62.0/31.0	500	30.16		A175
	1800	575	284T	<b>GT1128</b>	284TTFCA6030	✓	\$2,483	E1	93.6	24.4	500	30.16		A175
	1200	208-230/460	324T	<b>GT1029</b>	324TTFCA6076	✓	\$4,403	E1	93.0	66.0/33.0	675	32.68		A177
	1200	575	324T	<b>GT1129</b>	324TTFCA6080	✓	\$4,403	E1	93.0	26.8	675	32.68		A177
30	3600	208-230/460	286TS	<b>GT1030</b>	286TSTFCA6001	✓	\$3,178	E1	91.7	66.0/33.0	500	30.00		A174
	3600	575	286TS	<b>GT1130</b>	286TSTFCA6005	✓	\$3,178	E1	91.7	27.2	500	30.00		A174
	1800	208-230/460	286T	<b>GT1031</b>	286TTFCA6026	✓	\$2,888	E1	93.6	73.0/36.5	525	31.34		A175
	1800	575	286T	<b>GT1131</b>	286TTFCA6030	✓	\$2,888	E1	93.6	29.2	252	31.34		A175
	1200	208-230/460	326T	<b>GT1032</b>	326TTFCA6076	✓	\$5,070	E1	93.0	80.0/40.0	725	33.86		A177
	1200	575	326T	<b>GT1132</b>	326TTFCA6080	✓	\$5,070	E1	93.0	32.0	725	33.86		A177
40	3600	208-230/460	324TS	<b>GT1033</b>	324TSTFCA6001	✓	\$4,192	E1	92.4	88.0/44.0	675	31.26		A176
	3600	575	324TS	<b>GT1133</b>	324TSTFCA6005	✓	\$4,192	E1	92.4	35.0	675	31.26		A176
	1800	208-230/460	324T	<b>GT1034</b>	324TTFCA6026	✓	\$3,836	E1	94.1	94.0/47.0	750	32.68		A177
	1800	575	324T	<b>GT1134</b>	324TTFCA6030	✓	\$3,836	E1	94.1	37.5	750	32.68		A177
	1200	208-230/460	364T	<b>GT1035</b>	364TTFCA6086	✓	\$6,871	E1	94.1	94.0/47.0	950	36.61		A179
	1200	575	364T	<b>GT1135</b>	364TTFCA6080	✓	\$6,871	E1	94.1	38.5	950	36.61		A179
50	3600	208-230/460	326TS	<b>GT1036</b>	326TSTFCA6001	✓	\$5,422	E1	93.0	109/54.5	725	32.44		A176
	3600	575	326TS	<b>GT1136</b>	326TSTFCA6005	✓	\$5,422	E1	93.0	43.5	725	32.44		A176
	1800	208-230/460	326T	<b>GT1037</b>	326TTFCA6026	✓	\$4,710	E1	94.5	119/59.5	775	33.86		A177
	1800	575	326T	<b>GT1137</b>	326TTFCA6030	✓	\$4,710	E1	94.5	47.5	775	33.86		A177
	1200	208-230/460	365T	<b>GT1038</b>	365TTFCA6086	✓	\$7,892	E1	94.1	117/58.5	1000	38.39		A179
	1200	575	365T	<b>GT1138</b>	365TTFCA6080	✓	\$7,892	E1	94.1	47.0	1000	38.39		A179
60	3600	208-230/460	364TS	<b>GT1039</b>	364TSTFCA6001	✓	\$7,134	E1	93.6	132/66.0	925	34.57		A178
	3600	575	364TS	<b>GT1139</b>	364TSTFCA6005	✓	\$7,134	E1	93.6	53.0	925	34.57		A178
	1800	208-230/460	364T	<b>GT1040</b>	364TTFCA6036	✓	\$6,758	E1	95.0	138/69.0	1000	36.61		A179
	1800	575	364T	<b>GT1140</b>	364TTFCA6040	✓	\$6,758	E1	95.0	55.0	1000	36.61		A179
	1200	208-230/460	404T	<b>GT1041</b>	404TTFCA6086	✓	\$9,246	E1	94.5	140/70.0	1200	42.72		A425
	1200	575	404T	<b>GT1141</b>	404TTFCA6080	✓	\$9,246	E1	94.5	56.0	1200	42.72		A425
75	3600	208-230/460	365TS	<b>GT1042</b>	365TSTFCA6001	✓	\$8,958	E1	94.1	164/82.0	1025	36.34		A178
	3600	575	365TS	<b>GT1142</b>	365TSTFCA6002	✓	\$8,958	E1	93.6	65.5	1025	36.34		A178
	1800	208-230/460	365T	<b>GT1043</b>	365TTFCA6036	✓	\$8,567	E1	95.4	170/85.0	1100	38.39		A179
	1800	575	365T	<b>GT1143</b>	365TTFCA6040	✓	\$8,567	E1	95.4	69.0	1100	38.39		A179
	1200	208-230/460	405T	<b>GT1044</b>	405TTFCA6086	✓	\$10,884	E1	94.5	174/87.0	1300	42.72		A425
	1200	575	405T	<b>GT1144</b>	405TTFCA6080	✓	\$10,884	E1	94.5	69.5	1300	42.72		A425

Catalog numbers (Cat No.) highlighted in bold blue have efficiency levels that meet EISA requirements

Blue shaded areas are Cast Iron Frames

Continued on next page.



# General Purpose, Three Phase Globetrotter® NEMA Premium® Efficiency Totally Enclosed

## Rigid Base

HP	RPM	VOLTS	FRAME	CAT. NO.	MODEL NO.	STOCK	LIST PRICE	MULT. SYMB.	NOM. EFF.	F.L. AMPS	APPROX WGT. LBS	"C" DIM.	FOOT NOTES	C FACE KITS
100	3600	208-230/460	405TS	<b>GT1045</b>	405TSTFC6001	✓	\$12,003	E1	94.5	216/108	1250	39.76		A424
	3600	575	405TS	<b>GT1145</b>	405TSTFC6005	✓	\$12,003	E1	94.1	87.5	1250	39.76		A424
	1800	208-230/460	405T	<b>GT1046</b>	405TTFC6036	✓	\$10,584	E1	95.4	224/112	1375	42.72		A425
	1800	575	405T	<b>GT1146</b>	405TTFC6040	✓	\$10,584	E1	95.4	89.5	1375	42.72		A425
	1200	208-230/460	444T	<b>GT1047</b>	444TTFC6086	✓	\$16,050	E1	95.0	228/114	2000	50.79		A427
	1200	575	444T	<b>GT1147</b>	444TTFC6080	✓	\$16,050	E1	95.0	91	2000	50.79		A427
125	3600	460	444TS	<b>GT1048</b>	444TSTFC6001	✓	\$15,691	E1	95.0	136	1750	47.05		A426
	3600	575	444TS	<b>GT1148</b>	444TSTFC16002	✓	\$15,691	E1	95.0	109	1750	47.05		A426
	1800	460	444T	<b>GT1049</b>	444TTFC6036	✓	\$13,934	E1	95.4	140	1850	50.79		A427
	1800	575	444T	<b>GT1149</b>	444TTFC6044	✓	\$13,934	E1	95.4	112	1850	50.79		A427
	1200	460	445T	<b>GT1050</b>	445TTFC6086	✓	\$18,272	E1	95.0	142	2050	50.79		A427
	1200	575	445T	<b>GT1150</b>	445TTFC6080	✓	\$18,272	E1	95.0	114	2050	50.79		A427
150	3600	460	445TS	<b>GT1051</b>	445TSTFC6001	✓	\$18,850	E1	95.0	162	2050	47.05		A426
	3600	575	445TS	<b>GT1151</b>	445TSTFC6005	✓	\$18,850	E1	95.0	130	2050	47.05		A426
	1800	460	445T	<b>GT1052</b>	445TTFC6036	✓	\$16,199	E1	95.8	165	2050	50.79		A427
	1800	575	445T	<b>GT1152</b>	445TTFC6037	✓	\$16,199	E1	95.8	132	2050	50.79		A427
	1200	460	447T	<b>GT1053</b>	447TTFC6087	✓	\$20,444	E1	95.8	170	2500	55.91		A429
	1200	575	447T	<b>GT1153</b>	447TTFC6080	✓	\$20,444	E1	95.8	136	2500	55.91		A429
200	3600	460	447TS	<b>GT1054</b>	447TSTFC16004	✓	\$23,846	E1	95.4	215	2300	52.17		A428
	3600	575	447TS	<b>GT1154</b>	447TSTFC6005	✓	\$23,846	E1	95.4	172	2300	52.17		A428
	1800	460	447T	<b>GT1055</b>	447TTFC6038	✓	\$19,701	E1	96.2	225	2350	55.91		A429
	1800	575	447T	<b>GT1155</b>	447TTFC6039	✓	\$19,701	E1	96.2	180	2350	55.91	A	A429
	1200	460	449T	<b>GT1056</b>	449TTFC6088	✓	\$25,026	E1	95.8	228	2900	55.91		A429
	1200	575	449T	<b>GT1156</b>	449TTFC6080	✓	\$25,026	E1	95.8	182	2900	55.91		A429

Catalog numbers (Cat No.) highlighted in bold blue have efficiency levels that meet EISA requirements

Blue shaded areas are Cast Iron Frames

# General Purpose, Three Phase Globetrotter® NEMA Premium® Efficiency

Totally Enclosed, C-Face Footless and C-Face Footed (Rigid Base)

Features:

☑ Meets or exceeds NEMA Premium® efficiencies

NEMA Premium® models are in compliance with EISA2007

- 182TC-215TC models steel frame, 254TC-405TC models cast iron frame and brackets
- Inverter Duty 10:1 Variable Torque and 10:1 Constant Torque, 1.0 SF
- 1.15 Service Factor
- Class F Insulation
- Standard assembly F1, reversible to F2 assembly
- UL Recognized, CSA Certified, CE Mark
- Three year warranty



## C-Face Footless

HP	RPM	VOLTS	FRAME	CAT. NO.	MODEL NO.	STOCK	LIST PRICE	MULT. SYMB.	NOM. EFF.	F.L. AMPS	WEIGHT	"C" DIM.	FOOT NOTES
1 1/2	1200	208-230/460	182TC	<b>GT1305</b>	182TTFB6079	✓	\$887	E1	87.5	4.8/2.4	82	15.75	
2	1200	230/460	184TC	<b>GT1308</b>	184TTFB6079	✓	\$994	E1	88.5	6.0/3.0	94	16.73	
3	3600	208-230/460	182TC	<b>GT1309</b>	182TTFB6004	✓	\$928	E1	86.5	7.6/3.8	83	15.75	A
	1800	208-230/460	182TC	<b>GT1310</b>	182TTFB6029	✓	\$848	E1	89.5	7.8/3.9	87	15.75	
5	1200	208-230/460	213TC	<b>GT1311</b>	213TTFBA6079	✓	\$1,179	E1	89.5	8.6/4.3	115	19.53	
	3600	208-230/460	184TC	<b>GT1312</b>	184TTFB6004	✓	\$1,052	E1	88.5	13.4/6.7	95	16.73	A
	1800	208-230/460	184TC	<b>GT1313</b>	184TTFB6029	✓	\$965	E1	89.5	12.4/6.2	110	16.73	
7 1/2	1200	208-230/460	215TC	<b>GT1314</b>	215TTFBA6079	✓	\$1,475	E1	89.5	14.0/7.0	135	21.02	
	3600	208-230/460	213TC	<b>GT1315</b>	213TTFBA6004	✓	\$1,258	E1	89.5	17.8/8.9	116	19.53	
	1800	208-230/460	213TC	<b>GT1316</b>	213TTFBA6029	✓	\$1,011	E1	91.7	18.6/9.3	143	19.53	
10	3600	208-230/460	215TC	<b>GT1318</b>	215TTFBA6004	✓	\$1,329	E1	90.2	22.8/11.4	137	21.02	
	1800	208-230/460	215TC	<b>GT1319</b>	215TTFBA6029	✓	\$1,295	E1	91.7	24.4/12.2	164	21.02	

## C-Face Footed (Rigid Base)

HP	RPM	VOLTS	FRAME	CAT. NO.	MODEL NO.	STOCK	LIST PRICE	MULT. SYMB.	NOM. EFF.	F.L. AMPS	WEIGHT	"C" DIM.	FOOT NOTES
1	1800	208-230/460	143TC	<b>GT1201</b>	143TTFR6032	✓	\$478	E1	85.5	3.3/1.65	59	13.87	
	1800	575	143TC	<b>GT1401</b>	143TTFR16039	✓	\$478	E1	85.5	1.3	59	13.87	A
	1200	208-230/460	145TC	<b>GT1202</b>	145TTFR16079	✓	\$626	E1	82.5	3.8-3.8/1.9	74	14.87	
1 1/2	3600	208-230/460	143TC	<b>GT1203</b>	143TTFR6010	✓	\$510	E1	84.0	4.0/2.0	63	13.87	
	3600	575	143TC	<b>GT1403</b>	143TTFR16003	✓	\$510	E1	84.0	1.6	63	13.37	
	1800	208-230/460	145TC	<b>GT1204</b>	145TTFR6058	✓	\$485	E1	86.5	4.6/2.3	68	14.37	
	1800	575	145TC	<b>GT1404</b>	145TTFR16046	✓	\$485	E1	86.5	2.0	68	14.37	A
	1200	208-230/460	182TC	<b>GT1205</b>	182TTFB6078	✓	\$701	E1	87.5	4.8/2.4	82	15.75	
2	3600	208-230/460	145TC	<b>GT1206</b>	145TTFR6009	✓	\$559	E1	85.5	5.6-5.2/2.6	71	14.37	
	3600	575	145TC	<b>GT1406</b>	145TTFR16005	✓	\$559	E1	85.5	2.0	71	14.37	
	1800	208-230/460	145TC	<b>GT1207</b>	145TTFR6040	✓	\$520	E1	86.5	6.0/3.0	76	14.87	A
	1800	575	145TC	<b>GT1407</b>	145TTFR16047	✓	\$520	E1	86.5	2.4	76	14.87	A
	1200	230/460	184TC	<b>GT1208</b>	184TTFB6078	✓	\$803	E1	88.5	6.0/3.0	94	16.73	
3	3600	208-230/460	182TC	<b>GT1209</b>	182TTFB6003	✓	\$740	E1	86.5	7.6/3.8	83	15.75	
	3600	575	182TC	<b>GT1409</b>	182TTFB6007	✓	\$740	E1	86.5	3.0	83	15.75	
	1800	208-230/460	182TC	<b>GT1210</b>	182TTFB6028	✓	\$697	E1	89.5	7.8/3.9	87	15.75	
	1800	575	182TC	<b>GT1410</b>	182TTFB6032	✓	\$697	E1	89.5	3.1	87	15.75	
	1200	208-230/460	213TC	<b>GT1211</b>	213TTFBA6078	✓	\$979	E1	89.5	8.6/4.3	115	19.53	

Catalog numbers (Cat No.) highlighted in bold blue have efficiency levels that meet EISA requirements

Continued on next page.

# General Purpose, Three Phase Globetrotter® NEMA Premium® Efficiency

## C-Face Footed (Rigid Base)

HP	RPM	VOLTS	FRAME	CAT. NO.	MODEL NO.	STOCK	LIST PRICE	MULT. SYMB.	NOM. EFF.	F.L. AMPS	WEIGHT	"C" DIM.	FOOT NOTES
5	3600	208-230/460	184TC	<b>GT1212</b>	184TTFB6003	✓	\$858	E1	88.5	13.4/6.7	95	16.73	
	3600	575	184TC	<b>GT1412</b>	184TTFB6007	✓	\$858	E1	88.5	4.8	95	16.73	
	1800	208-230/460	184TC	<b>GT1213</b>	184TTFB6032	✓	\$775	E1	89.5	12.4/6.2	110	16.73	
	1800	575	184TC	<b>GT1413</b>	184TTFB3062	✓	\$775	E1	89.5	5.1	110	16.73	
	1200	208-230/460	215TC	<b>GT1214</b>	215TTFBA6078	✓	\$1,261	E1	89.5	14.0/7.0	135	21.02	
7 1/2	3600	208-230/460	213TC	<b>GT1215</b>	213TTFBA6003	✓	\$1,054	E1	89.5	17.8/8.9	116	19.53	A
	3600	575	213TC	<b>GT1415</b>	213TTFBA6007	✓	\$1,054	E1	89.5	7.1	116	19.53	
	1800	208-230/460	213TC	<b>GT1216</b>	213TTFBA6028	✓	\$957	E1	91.7	18.6/9.3	143	19.53	
	1800	575	213TC	<b>GT1416</b>	213TTFBA6032	✓	\$957	E1	91.7	8.6	143	19.53	
	1200	208-230/460	254TC	<b>GT1217</b>	254TTFCA6078	✓	\$1,945	E1	91.0	20.4/10.2	300	26.60	
10	3600	208-230/460	215TC	<b>GT1218</b>	215TTFBA6003	✓	\$1,122	E1	90.2	22.8/11.4	137	21.02	
	3600	575	215TC	<b>GT1418</b>	215TTFBA6007	✓	\$1,122	E1	90.2	9.4	137	21.02	
	1800	208-230/460	215TC	<b>GT1219</b>	215TTFBA6028	✓	\$1,089	E1	91.7	24.4/12.2	164	21.02	
	1800	575	215TC	<b>GT1419</b>	215TTFBA6032	✓	\$1,089	E1	91.7	10.7	164	21.02	
	1200	208-230/460	256TC	<b>GT1220</b>	256TTFCA6078	✓	\$2,333	E1	91.0	28.0/14.0	368	27.80	
15	3600	208-230/460	254TC	<b>GT1221</b>	254TTFCA6003	✓	\$1,892	E1	91.0	34.0/17.0	350	26.60	
	3600	575	254TC	<b>GT1421</b>	254TTFCA6007	✓	\$1,892	E1	91.0	14.2	350	26.60	
	1800	208-230/460	254TC	<b>GT1222</b>	254TTFCA6028	✓	\$1,788	E1	92.4	37.0/18.5	350	26.60	
	1800	575	254TC	<b>GT1422</b>	254TTFCA6032	✓	\$1,788	E1	92.4	15.8	350	26.60	
	20	3600	208-230/460	256TC	<b>GT1224</b>	256TTFCA6003	✓	\$2,298	E1	91.0	46.0/23.0	375	27.80
20	1800	208-230/460	256TC	<b>GT1225</b>	256TTFCA6028	✓	\$2,180	E1	93.0	49.0/24.5	425	27.80	
	25	3600	208-230/460	284TSC	<b>GT1227</b>	284STFCA6003	✓	\$2,900	E1	91.7	56.0/28.0	475	28.79
25	1800	208-230/460	284TC	<b>GT1228</b>	284TTFCA6028	✓	\$2,673	E1	93.6	61.0/30.5	500	30.16	YD
	30	3600	208-230/460	286TSC	<b>GT1230</b>	286STFCA6003	✓	\$3,335	E1	91.7	68.0/34.0	500	39.97
30	1800	208-230/460	286TC	<b>GT1231</b>	286TTFCA6028	✓	\$3,058	E1	93.6	73.0/36.5	525	31.34	YD
	40	3600	208-230/460	324TSC	<b>GT1233</b>	324STFCA6003	✓	\$4,435	E1	92.4	88.0/44.0	675	31.18
40	1800	208-230/460	324TC	<b>GT1234</b>	324TTFCA6028	✓	\$4,096	E1	94.1	94.0/47.0	750	32.68	YD
	50	3600	208-230/460	326TSC	<b>GT1236</b>	326STFCA6003	✓	\$5,607	E1	93.0	109/54.5	725	32.36
50	1800	208-230/460	326TC	<b>GT1237</b>	326TTFCA6028	✓	\$4,929	E1	94.5	119/59.5	775	33.86	YD
	60	3600	208-230/460	364TSC	<b>GT1239</b>	364STFCA6003	✓	\$7,435	E1	93.6	132/66.0	925	34.48
60	1800	208-230/460	364TC	<b>GT1240</b>	364TTFCA6038	✓	\$7,077	E1	95.0	138/69.0	1000	36.61	YD
	75	3600	208-230/460	365TSC	<b>GT1242</b>	365STFCA6003	✓	\$9,172	E1	93.6	164/82.0	1025	36.26
75	1800	208-230/460	365TC	<b>GT1243</b>	365TTFCA6038	✓	\$8,800	E1	95.4	173/86.5	1100	38.39	YD
	100	3600	208-230/460	405TSC	<b>GT1245</b>	405STFC6003	✓	\$12,388	E1	94.5	224/112	1250	39.76
100	1800	208-230/460	405TC	<b>GT1246</b>	405TTFC6038	✓	\$11,037	E1	95.4	224/112	1375	42.76	YD

Catalog numbers (Cat No.) highlighted in bold blue have efficiency levels that meet EISA requirements

Blue shaded areas are Cast Iron Frames

GENERAL PURPOSE THREE PHASE

# Severe Duty, Totally Enclosed Wet Environment / Car Wash Motor

## C-Face Footless, Three Phase

### Features:

- 303 Stainless steel shafts with contact lip seal & V-ring slinger
- Rolled Steel construction
- Gray epoxy paint
- Class F insulation
- 1.15 Service Factor (except as noted)
- Automatic thermal protection

**IP55**

HP	RPM	VOLTS	FRAME	CAT. NO.	MODEL NO.	STOCK	LIST PRICE	MULT. SYMB.	NOM. EFF.	F.L. AMPS	WEIGHT	"C" DIM.	FOOT NOTES
1/2	1800	230/460	56C	K606	5K42GN4619	✓	\$472	F3	72.0	2.2/1.1	30	11.19	
3/4	1800	230/460	56C	K607	5K49MN4620	✓	\$518	F3	77.0	3.0/1.5	30	11.69	
1	1800	230/460	56C	K608	5K49MN4618	✓	\$542	F3	77.0	3.8/1.9	30	11.69	
1 1/2	1800	230/460	56C	K610	5K49RN4621	✓	\$598	F3	80.0	5.0/2.5	33	12.19	
2	1800	230/460	56C	K609	5K49TN4622	✓	\$637	F3	81.5	6.2/3.1	38	12.69	17

# Blue Chip® Severe Duty / Cooling Tower: Single Speed

## Rigid Base, Three Phase

### Features:

- Blue Chip® quality, 100% cast iron construction for rigidity and reduced vibration
- Internal and external epoxy paint
- Class F insulation
- 1.15 Service Factor
- Rated 60/50 hertz, 190/380 or 380 volt at next lower horsepower
- Extended grease tubes, regreasable in service
- T-drains provided for effective drainage (Installed in both endshields)
- Suitable for shaft down mounting
- Shaft Slinger
- Forsheda seals on both ends
- Ball Bearings
- Actual test and vibration data supplied with each motor
- UL Recognized and CSA Certified
- Suitable for 10:1 VT and CT (as noted) on VFD
- Two year warranty

**IP55**

Suitable for use on VFD per guidelines on page 17.

HP	RPM	VOLTS	FRAME	CAT. NO.	MODEL NO.	STOCK	CT SPEED RANGE*	LIST PRICE	MULT. SYMB.	NOM. EFF.	F.L. AMPS	WEIGHT	"C" DIM.	FOOT NOTES
3	1800	230/460	182T	<b>U867A</b>	182TTFN6557		10:1	\$986	S3	90.2	8.0/4.0	145	15.87	
5	1800	230/460	184T	<b>U868A</b>	184TTFN6555	✓	10:1	\$1,078	S3	90.2	12.4/6.2	128	17.87	
7 1/2	1800	230/460	213T	<b>U869A</b>	213TTFN6550	✓	10:1	\$1,360	S3	91.7	19.2/9.6	273	18.22	
10	1800	230/460	215T	<b>U870A</b>	215TTFN6546	✓	10:1	\$1,558	S3	91.7	25/12.5	267	19.72	
15	1800	230/460	254T	<b>U871A</b>	254TTFNA16568	✓	10:1	\$2,010	S3	92.4	37.5/18.8	349	23.52	
20	1800	230/460	256T	<b>U872A</b>	256TTFNA16574	✓	10:1	\$2,363	S3	93.0	48.0/24.1	375	25.27	
25	1800	230/460	284T	<b>U873A</b>	284TTFNA16832	✓	10:1	\$2,801	S3	93.6	62.0/31.0	440	26.34	
30	1800	230/460	286T	<b>U874A</b>	286TTFNA16572	✓	10:1	\$3,278	S3	94.1	73.0/36.5	503	27.84	
40	1800	230/460	324T	<b>U875A</b>	324TTFN16837	✓	2:1	\$4,249	S3	94.1	95.0/47.5	567	30.37	
50	1800	230/460	326T	<b>U876A</b>	326TTFN16574	✓	2:1	\$5,351	S3	94.5	120/60.0	644	30.37	
60	1800	230/460	364T	<b>U877A</b>	364TTFN16558	✓	2:1	\$7,489	S3	95.0	138/69.0	1078	31.50	
75	1800	230/460	365T	<b>U878A</b>	365TTFN16827	✓	2:1	\$9,323	S3	95.4	172/86.0	1169	32.50	
100	1800	230/460	405T	<b>U879A</b>	405TTFN16834	✓	2:1	\$11,545	S3	95.4	226/113	1458	37.12	
125	1800	460	444T	<b>U880A</b>	444TTFN16549	✓	2:1	\$14,863	S3	95.4	145	1990	43.35	
150	1800	460	445T	<b>U881A</b>	445TTFN16866		2:1	\$17,698	S3	95.8	172	2343	43.35	d
200	1800	460	445T	<b>U882A</b>	445TTFN16852		2:1	\$21,125	S3	96.2	226	2556	43.35	
250	1800	460	445T	<b>U884</b>	445TTFN4575		2:1	\$20,413	S3	95.0	285	2409	43.26	

Catalog numbers (Cat No.) highlighted in bold blue have efficiency levels that meet EISA requirements

Blue shaded areas are Cast Iron Frames

\* Requires nameplate modification

# Blue Chip® Severe Duty / Automotive Duty NEMA Premium® XRI®

## Totally Enclosed, Rigid Base, Three Phase

### Applications:

Chemical plants, paper mills, refineries, mines, food processing, foundries, and other severe duty environments where long life and ultra-high efficiency are desired. Guaranteed efficiencies offer an eXtra Return on your Investment when using these premium efficiency motors on high cycle or long run applications.



### Features:

⊕ Meets or exceeds NEMA Premium® efficiencies, except where noted NEMA Premium® models are in compliance with EISA2007

- Blue Chip® quality, 100% cast iron construction for rigidity and reduced vibration
- Provisions to add stub shaft for an encoder (182T-449T, TEFC only)
- Internal and external epoxy paint
- MAX GUARD® Class F insulation system
- Constant Torque speed range is listed in CT SPEED RANGE column
- 1.15 Service Factor on sinewave, 1.0 Service Factor on IGBT power
- Bearing caps (254T and larger)
- Precision balanced to .08"/sec
- Extended grease tubes, regreasable in service
- Brass drain and breather
- Meets IEEE45 USCG Marine Duty, IP54 Construction
- Meets Ford EM1 Automotive Duty Specification
- Hazardous Duty™ Division 2 CSA certification nameplate
- Division 2 / Zone 2 Class I (gases), Groups A, B, C, D
- Meets temperature code T2B
- Actual test and vibration data supplied with each motor
- Ball bearings (except as noted)
- UL Recognized (through 449T) and CSA Certified and CE Marked
- Three year warranty

Models through 40 HP are capable of modification as follows (contact factory to confirm):

- 1.25 Service Factor (sinewave only)
- 50Hz at same HP, 1.0 Service Factor (sinewave only)
- Any nameplate changes are subject to modification charges (see MOD Central section)
- Contact Marathon Motors for optional nameplate markings on 50 HP and larger

Suitable for use on VFD per guidelines on page 17.



HP	RPM	VOLTS	FRAME	CAT. NO.	MODEL NO.	STOCK	CT SPEED RANGE*	LIST PRICE	MULT. SYMB.	NOM. EFF.	F.L. AMPS	WEIGHT	"C" DIM.	FOOT NOTES	C FACE KITS
3/4	1200	460	143T	E648	143TTTN6576	√	1000:1	\$600	E9	80.0	1.4	53	10.43	75,76,N,NE	A603
	1200	460	143T	E373	143TTFN6576		20:1	\$660	E9	80.0	1.4	53	12.92	75,76,NE	A603
1	1800	460	143T	E649	143TTTN6526	√	1000:1	\$490	E9	85.5	1.5	55	10.43	75,76,N,NE	A603
	1800	460	143T	<b>E374</b>	143TTFN6526		20:1	\$539	E9	85.5	1.5	71	12.92	75,76	A603
	1800	230/460	143T	E461	143TTTN6563	√	1000:1	\$490	E9	85.5	3.1/1.5	55	12.95	75,76,N,NE	A603
	1800	230/460	143T	<b>E375</b>	143TTFN6563		20:1	\$539	E9	85.5	3.1/1.5	71	12.95	75,76	A603
	1800	575	143T	E666	143TTTN6530	√	1000:1	\$490	E9	85.5	1.2	55	10.43	75,76,N,NE	A603
	1800	575	143T	<b>E376</b>	143TTFN16539		20:1	\$539	E9	85.5	1.2	71	14.17	75,76	A603
	1200	460	145T	E650	145TTTN6576	√	1000:1	\$616	E9	80.0	1.65	60	11.43	75,76,N,NE	A655
	1200	230/460	145T	E462	145TTTN6584		1000:1	\$616	E9	80.0	3.3/1.65	60	11.43	75,76,N,NE	A655
1 1/2	3600	460	143T	E651	143TTTN6501	√	1000:1	\$613	E9	86.5	2.0	58	10.43	75,76,N,NE	A603
	3600	460	143T	<b>E377</b>	143TTFN6501		20:1	\$673	E9	85.5	2.0	64	14.17	75,76	A603
	3600	230/460	143T	E463	143TTTN6502		1000:1	\$613	E9	86.5	4.0/2.0	58	10.43	75,76,N,NE	A603
	3600	230/460	143T	<b>E378</b>	143TTFN6502		20:1	\$673	E9	85.5	4.0/2.0	64	14.17	75,76	A603
	3600	575	143T	E851	143TTTN6505		1000:1	\$613	E9	86.5	1.6	58	10.43	75,76,N,NE	A603
	3600	575	143T	<b>E379</b>	143TTFN6505		20:1	\$673	E9	85.5	1.6	64	14.17	75,76	A603
	1800	460	145T	E652	145TTTN6526	√	1000:1	\$531	E9	84.0	2.2	65	11.43	75,76,N,NE	A655
	1800	230/460	145T	E464	145TTTN6834	√	1000:1	\$531	E9	84.0	4.4/2.2	65	11.43	75,76,N,NE	A655
	1800	575	145T	E667	145TTTN6529		1000:1	\$531	E9	84.0	1.8	65	11.43	75,76,N,NE	A655
	1200	460	182T	E632	182TTTS6576	√	1000:1	\$788	E9	87.5	2.2	100	12.71	75,76,N,NE	A644
	1200	460	182T	<b>E380</b>	182TTFS6576		20:1	\$867	E9	87.5	2.2	110	15.19	75	A644
	1200	230/460	182T	E465	182TTTS6578		1000:1	\$788	E9	87.5	4.4/2.2	100	12.71	75,N,NE	A644
2	3600	460	145T	E653	145TTTN6501	√	1000:1	\$642	E9	85.5	2.5	68	11.43	75,76,N,NE	A655
	3600	460	145T	<b>E382</b>	145TTFN6501		20:1	\$707	E9	85.5	2.0	80	14.17	75,76	A655
	3600	230/460	145T	E466	145TTTN6521		1000:1	\$642	E9	85.5	5.0/2.5	68	11.43	75,76,N,NE	A655
	3600	230/460	145T	<b>E383</b>	145TTFN6521		20:1	\$707	E9	85.5	4.0/2.0	80	14.17	75,76	A655
3600	575	145T	E852	145TTTN6505		1000:1	\$642	E9	85.5	2.0	68	11.43	75,76,N,NE	A655	

Catalog numbers (Cat No.) highlighted in bold blue have efficiency levels that meet EISA requirements

Blue shaded areas are Cast Iron Frames

\* Requires nameplate modification

Continued on next page.

# Blue Chip® Severe Duty / Automotive Duty

## NEMA Premium® XRI®

### Totally Enclosed, Rigid Base, Three Phase

SEVERE DUTY

HP	RPM	VOLTS	FRAME	CAT. NO.	MODEL NO.	STOCK	CT SPEED RANGE*	LIST PRICE	MULT. SYMB.	NOM. EFF.	F.L. AMPS	WEIGHT	"C" DIM.	FOOT NOTES	C FACE KITS
2	1800	460	145T	E654	145TTTN6527	✓	1000:1	\$584	E9	85.5	3.0	68	11.43	75,76,N,NE	A655
	1800	230/460	145T	E467	145TTTN6835	✓	1000:1	\$584	E9	85.5	6.0/3.0	68	11.43	75,76,N,NE	A655
	1800	230/460	145T	<b>E386</b>	145TTFN6835		20:1	\$642	E9	86.5	5.6/2.8	68	14.17	75,76	A655
	1800	575	145T	E668	145TTTN6530		1000:1	\$584	E9	85.5	2.4	68	11.43	75,76,N,NE	A655
	1200	460	184T	E633	184TTTS6576	✓	1000:1	\$974	E9	88.5	3.0	112	13.71	75,N,NE	A644
	1200	460	184T	<b>E388</b>	184TTFS6576		20:1	\$1,071	E9	88.5	2.9	110	16.19	75	A644
	1200	230/460	184T	E468	184TTTS6582	✓	1000:1	\$974	E9	88.5	6.0/3.0	112	13.71	75,N,NE	A644
3	3600	460	182T	E601	182TTTS6501	✓	1000:1	\$882	E9	87.5	3.8	98	12.71	75,N,NE	A644
	3600	230/460	182T	<b>E390</b>	182TTFS6501		20:1	\$971	E9	87.5	3.8	105	15.19	75	A644
	3600	575	182T	E853	182TTTS6505		1000:1	\$882	E9	87.5	3.0	105	12.71	75,N,NE	A644
	3600	575	182T	<b>E392</b>	182TTFS6505		20:1	\$971	E9	87.5	3.0	105	21.57	75	A644
	1800	460	182T	E616	182TTTS6526	✓	1000:1	\$791	E9	90.2	4.0	102	12.71	75,N,NE	A644
	1800	230/460	182T	E470	182TTTS6538	✓	1000:1	\$791	E9	90.2	8.0/4.0	102	12.71	75,N,NE	A644
	1800	575	182T	E669	182TTTS6530	✓	1000:1	\$791	E9	90.2	3.2	102	12.71	75,N,NE	A644
	1200	460	213T	<b>E634</b>	213TTFS6576	✓	20:1	\$1,199	E9	89.5	4.4	176	18.22	75	A206
	1200	230/460	213T	<b>E471</b>	213TTFS6594	✓	20:1	\$1,199	E9	89.5	8.8/4.4	176	18.22	75	A206
	5	3600	460	184T	<b>E602</b>	184TTFS6501	✓	2:1	\$980	E9	89.5	5.9	142	16.19	75
3600		230/460	184T	<b>E472</b>	184TTFS6810	✓	2:1	\$980	E9	89.5	11.8/5.9	142	16.19	75	A644
3600		575	184T	<b>E655</b>	184TTFS6505	✓	20:1	\$980	E9	89.5	4.7	142	16.19	75	A644
1800		460	184T	<b>E617</b>	184TTFS6526	✓	20:1	\$917	E9	90.2	6.2	130	16.19	75	A644
1800		230/460	184T	<b>E473</b>	184TTFS6844	✓	20:1	\$917	E9	90.2	12.4/6.2	130	16.19	75	A644
1800		575	184T	<b>E670</b>	184TTFS6530	✓	20:1	\$917	E9	90.2	5.0	130	16.19	75	A644
1200		460	215T	<b>E635</b>	215TTFS6576	✓	20:1	\$1,473	E9	89.5	6.9	202	19.72	75	A206
1200		230/460	215T	<b>E474</b>	215TTFS6881	✓	20:1	\$1,473	E9	89.5	13.8/6.9	202	19.72	75	A206
1200		575	215T	<b>E683</b>	215TTFS6580		20:1	\$1,473	E9	89.5	5.5	202	19.72	75	A206
7 1/2		3600	460	213T	E603	213TTTS6501	✓	1000:1	\$1,184	E9	91.7	8.9	200	17.19	75,N,NE
	3600	460	213T	<b>E396</b>	213TTFS6501		2:1	\$1,303	E9	89.5	8.9	175	19.72	75	A206
	3600	230/460	213T	E475	213TTTS6502	✓	1000:1	\$1,184	E9	91.7	17.8/8.9	200	17.19	75,N,NE	A206
	3600	575	213T	E656	213TTTS6505	✓	1000:1	\$1,184	E9	91.7	7.1	200	17.19	75,N,NE	A206
	1800	460	213T	<b>E618</b>	213TTFS6526	✓	20:1	\$1,124	E9	91.7	9.6	200	19.72	75	A206
	1800	230/460	213T	<b>E476</b>	213TTFS6531	✓	20:1	\$1,124	E9	91.7	19.2/9.6	200	19.72	75	A206
	1800	575	213T	<b>E671</b>	213TTFS6530	✓	20:1	\$1,124	E9	91.7	7.7	200	19.72	75	A206
	1200	460	254T	<b>E636</b>	254TTFNA6576	✓	20:1	\$1,909	E9	91.0	9.9	326	23.52	75	A284
	1200	230/460	254T	<b>E477</b>	254TTFNA6590	✓	20:1	\$1,909	E9	91.0	19.8/9.9	326	23.52	75	A284
	1200	575	254T	<b>E684</b>	254TTFNA6578		20:1	\$1,909	E9	91.0	7.9	326	23.52	75	A284
10	3600	460	215T	<b>E604</b>	215TTFS6501	✓	2:1	\$1,382	E9	91.7	11.8	218	19.72	75	A206
	3600	230/460	215T	<b>E478</b>	215TTFS6807	✓	2:1	\$1,382	E9	91.7	23.6/11.8	218	19.72	75	A206
	3600	575	215T	<b>E657</b>	215TTFS6505		2:1	\$1,382	E9	91.7	9.5	218	19.72	75	A206
	1800	460	215T	<b>E619</b>	215TTFS6526	✓	20:1	\$1,353	E9	91.7	12.5	225	19.72	75	A206
	1800	230/460	215T	<b>E479</b>	215TTFS6527	✓	20:1	\$1,353	E9	91.7	25.0/12.5	225	19.72	75	A206
	1800	575	215T	<b>E672</b>	215TTFS6530	✓	20:1	\$1,353	E9	91.7	10.0	225	19.72	75	A206
	1200	460	256T	<b>E637</b>	256TTFNA6576	✓	20:1	\$2,333	E9	91.0	13.1	405	25.27	75	A284
	1200	230/460	256T	<b>E480</b>	256TTFNA6596	✓	20:1	\$2,333	E9	91.0	26.2/13.1	405	25.27	75	A284
	1200	575	256T	<b>E685</b>	256TTFNA6578		20:1	\$2,333	E9	91.0	10.5	405	25.27	75	A284
	15	3600	460	254T	<b>E605</b>	254TTFNA6501	✓	2:1	\$1,852	E9	91.7	17.5	345	23.52	75
3600		230/460	254T	<b>E481</b>	254TTFNA6515	✓	2:1	\$1,852	E9	91.7	35.0/17.5	345	23.52	75	A284
3600		575	254T	<b>E658</b>	254TTFNA6503		2:1	\$1,852	E9	91.7	14.2	345	23.52	75	A284
1800		460	254T	<b>E620</b>	254TTFNA6526	✓	20:1	\$1,738	E9	92.4	18.8	350	23.52	75	A284
1800		460	254T	<b>E620-P</b>	254TTFNA16838	✓	20:1	\$1,912	E9	92.4	18.8	350	23.52	75,P	A284
1800		230/460	254T	<b>E482</b>	254TTFNA6529	✓	20:1	\$1,738	E9	92.4	37.6/18.8	350	23.52	75	A284
1800		575	254T	<b>E673</b>	254TTFNA6528	✓	20:1	\$1,738	E9	92.4	15.0	350	23.52	75	A284
1200		460	284T	<b>E638</b>	284TTFNA6576	✓	20:1	\$3,096	E9	91.7	20.4	479	26.34		A618
1200		230/460	284T	<b>E483</b>	284TTFNA6876	✓	20:1	\$3,096	E9	91.7	40.8/20.4	479	26.34		A618
1200		575	284T	<b>E694</b>	284TTFNA6580	✓	20:1	\$3,096	E9	91.7	16.3	479	26.34		A618

Catalog numbers (Cat No.) highlighted in bold blue have efficiency levels that meet EISA requirements

Blue shaded areas are Cast Iron Frames

\* Requires nameplate modification

Continued on next page.

# Blue Chip® Severe Duty / Automotive Duty NEMA Premium® XRI®

Totally Enclosed, Rigid Base, Three Phase

SEVERE DUTY

HP	RPM	VOLTS	FRAME	CAT. NO.	MODEL NO.	STOCK	CT SPEED RANGE*	LIST PRICE	MULT. SYMB.	NOM. EFF.	F.L. AMPS	WEIGHT	"C" DIM.	FOOT NOTES	C FACE KITS	
20	3600	460	256T	<b>E606</b>	256TTFNA6501	✓	2:1	\$2,294	E9	92.4	23.4	375	25.27	75	A284	
	3600	230/460	256T	<b>E484</b>	256TTFNA6523		2:1	\$2,294	E9	92.4	47.0/23.4	375	25.27	75	A284	
	3600	575	256T	<b>E659</b>	256TTFNA6503	✓	2:1	\$2,294	E9	92.4	18.7	375	25.27	75	A284	
	1800	460	256T	<b>E621</b>	256TTFNA6526	✓	20:1	\$2,166	E9	93.0	24.1	425	25.27	75	A284	
	1800	460	256T	<b>E621-P</b>	256TTFNA16855	✓	20:1	\$2,383	E9	93.0	24.1	425	25.27	75,P	A284	
	1800	230/460	256T	<b>E485</b>	256TTFNA6529	✓	20:1	\$2,166	E9	93.0	48.2/24.1	425	25.27	75	A284	
	1800	575	256T	<b>E674</b>	256TTFNA6528	✓	20:1	\$2,166	E9	93.0	19.3	425	25.27	75	A284	
	1200	460	286T	<b>E639</b>	286TTFNA6576	✓	20:1	\$3,771	E9	91.7	26.8	550	27.84		A618	
	1200	230/460	286T	<b>E486</b>	286TTFNA6876		20:1	\$3,771	E9	91.7	53.5/26.8	550	27.84		A618	
1200	575	286T	<b>E695</b>	286TTFNA6580		20:1	\$3,771	E9	91.7	21.4	550	27.84		A618		
25	3600	460	284TS	<b>E607</b>	284TSTFNA6501	✓	2:1	\$2,826	E9	93.6	28.1	481	24.97		A618	
	3600	575	284TS	<b>E660</b>	284TSTFNA6502		2:1	\$2,826	E9	93.6	22.5	481	24.97		A618	
	1800	460	284T	<b>E622</b>	284TTFNA6526	✓	20:1	\$2,579	E9	93.6	31.0	478	26.34		A618	
	1800	460	284T	<b>E622-P</b>	284TTFNA16851	✓	20:1	\$2,837	E9	93.6	31.0	478	26.34	P	A618	
	1800	230/460	284T	<b>E488</b>	284TTFNA6837	✓	20:1	\$2,579	E9	93.6	62.0/31.0	478	26.34		A618	
	1800	575	284T	<b>E675</b>	284TTFNA6527	✓	20:1	\$2,579	E9	93.6	24.8	478	26.34		A618	
	1200	460	324T	<b>E640</b>	324TTFNA6576	✓	20:1	\$4,571	E9	93.0	32.5	675	28.87		A214	
	1200	575	324T	<b>E696</b>	324TTFNA6577		20:1	\$4,571	E9	93.0	26.0	675	28.87		A214	
	30	3600	460	286TS	<b>E608</b>	286TSTFNA6501	✓	2:1	\$3,300	E9	93.6	34.1	500	26.47		A618
3600		230/460	286TS	<b>E490</b>	286TSTFNA6804	✓	2:1	\$3,300	E9	93.6	67.5/34.0	500	26.47		A618	
1800		460	286T	<b>E623</b>	286TTFNA6526	✓	20:1	\$2,999	E9	94.1	36.5	525	27.84		A618	
1800		460	286T	<b>E623-P</b>	286TTFNA16847	✓	20:1	\$3,299	E9	94.1	36.5	525	27.84	P	A618	
1800		230/460	286T	<b>E491</b>	286TTFNA6570	✓	20:1	\$2,999	E9	94.1	73.0/36.5	525	27.84		A618	
1800		575	286T	<b>E676</b>	286TTFNA6527	✓	20:1	\$2,999	E9	94.1	29.2	525	27.84		A618	
1200		460	326T	<b>E641</b>	326TTFNA6576	✓	20:1	\$5,266	E9	93.0	38.5	725	30.37		A214	
1200		575	326T	<b>E400</b>	326TTFNA6580		20:1	\$5,266	E9	93.0	31.0	725	30.37		A214	
40		3600	460	324TS	<b>E609</b>	324TSTFNA6501	✓	2:1	\$4,353	E9	93.6	47.0	656	27.37		A214
	3600	575	324TS	<b>E662</b>	324TSTFNA6505		2:1	\$4,353	E9	93.6	37.5	656	27.37		A214	
	1800	460	324T	<b>E624</b>	324TTFNA6526	✓	20:1@	\$3,983	E9	94.1	47.5	700	30.37		A214	
	1800	460	324T	<b>E624-P</b>	324TTFNA16860	✓	20:1@	\$4,381	E9	94.1	47.5	700	30.37	P	A214	
	1800	575	324T	<b>E677</b>	324TTFNA6527	✓	20:1@	\$3,983	E9	94.1	38.0	700	30.37		A214	
	1200	460	364T	<b>E642A</b>	364TTFNA16584	✓	20:1@	\$7,670	E9	94.1	50.0	882	31.50		A395	
	1200	575	364T	<b>E401A</b>	364TTFNA16585		20:1@	\$7,670	E9	94.1	40.0	882	31.50		A395	
	50	3600	460	326TS	<b>E610</b>	326TSTFNA6501	✓	2:1	\$5,631	E9	93.6	58.0	725	28.87		A214
		3600	575	326TS	<b>E663</b>	326TSTFNA6502		2:1	\$5,631	E9	93.6	46.5	725	28.87		A214
1800		460	326T	<b>E625</b>	326TTFNA6526	✓	20:1@	\$4,892	E9	94.5	60.0	775	31.87		A214	
1800		460	326T	<b>E625-P</b>	326TTFNA16844	✓	20:1@	\$5,381	E9	94.5	60.0	775	31.87	P	A214	
1800		460	326TS	<b>E453</b>	326TSTFNA6536		20:1@	\$4,892	E9	94.5	60.0	775	28.87		A214	
1800		575	326T	<b>E678</b>	326TTFNA6527	✓	20:1@	\$4,892	E9	94.5	48.0	775	30.37		A214	
1200		460	365T	<b>E643A</b>	365TTFNA16591	✓	20:1@	\$8,623	E9	94.1	61.5	946	32.50		A395	
1200		575	365T	<b>E402A</b>	365TTFNA16592		20:1@	\$8,623	E9	94.1	49.0	946	32.50		A395	
60		3600	460	364TS	<b>E611</b>	364TSTFNA6501	✓	2:1	\$7,407	E9	94.5	67.0	954	29.38		A396
	3600	575	364TS	<b>E664</b>	364TSTFNA6505		2:1	\$7,407	E9	94.5	53.5	954	29.38		A396	
	1800	460	364T	<b>E626</b>	364TTFNA6536	✓	20:1@	\$7,018	E9	95.0	69.0	980	31.50		A395	
	1800	460	364TS	<b>E454</b>	364TSTFNA6526		20:1@	\$7,018	E9	95.0	69.0	980	29.38		A396	
	1800	575	364T	<b>E679</b>	364TTFNA6537	✓	20:1@	\$7,018	E9	95.0	55.0	980	31.50		A395	
	1200	460	404T	<b>E644</b>	404TTFNA6586	✓	20:1@	\$9,602	E9	94.5	72.0	1156	35.62		A223	
	1200	575	404T	<b>E403</b>	404TTFNA6592		20:1@	\$9,602	E9	94.5	57.5	1156	35.62		A223	
	75	3600	460	365TS	<b>E612</b>	365TSTFNA6501	✓	2:1	\$9,302	E9	94.5	84.0	1002	30.38		A396
		3600	575	365TS	<b>E665</b>	365TSTFNA6502	✓	2:1	\$9,302	E9	94.5	67.0	1002	30.38		A396
1800		460	365T	<b>E627</b>	365TTFNA6536	✓	20:1@	\$8,896	E9	95.4	86.0	1100	32.50		A395	
1800		460	365TS	<b>E455</b>	365TSTFNA6526	✓	20:1@	\$8,896	E9	95.4	86.0	1100	30.38		A396	
1800		575	365T	<b>E680</b>	365TTFNA6537	✓	20:1@	\$8,896	E9	95.4	69.0	1100	32.50		A395	
1200		460	405T	<b>E645</b>	405TTFNA6586	✓	20:1@	\$11,304	E9	94.5	90.0	1280	37.12		A223	
1200		575	405T	<b>E404</b>	405TTFNA6587		20:1@	\$11,304	E9	94.5	71.5	1280	37.12		A223	

Catalog numbers (Cat No.) highlighted in bold blue have efficiency levels that meet EISA requirements

Blue shaded areas are Cast Iron Frames

\* Requires nameplate modification  
@ Requires larger fan

Continued on next page.

# Blue Chip® Severe Duty / Automotive Duty NEMA Premium® XRI®

## Totally Enclosed, Rigid Base, Three Phase

SEVERE DUTY

HP	RPM	VOLTS	FRAME	CAT. NO.	MODEL NO.	STOCK	CT SPEED RANGE*	LIST PRICE	MULT. SYMB.	NOM. EFF.	F.L. AMPS	WEIGHT	"C" DIM.	FOOT NOTES	C FACE KITS
100	3600	460	405TS	<b>E613</b>	405TSTFS6501	✓	2:1	\$12,465	E9	95.0	108	1295	34.12		A226
	3600	575	405TS	<b>E493</b>	405TSTFS6502		2:1	\$12,465	E9	95.0	87.0	1295	34.12		A226
	1800	460	405T	<b>E628</b>	405TTFS6536	✓	20:1@	\$10,991	E9	95.4	113	1330	37.12		A223
	1800	460	405TS	<b>E456</b>	405TSTFS6526	✓	20:1@	\$10,991	E9	95.4	113	1330	34.12		A226
	1800	575	405T	<b>E681</b>	405TTFS6538	✓	20:1@	\$10,991	E9	95.4	90.5	1330	37.12		A223
	1200	460	444T	<b>E327</b>	444TTFN16577		20:1@	\$16,975	E9	95.0	124	1970	41.34		A620
	1200	460	444T	<b>E646A</b>	444TTFN16581	✓	20:1@	\$16,975	E9	95.0	124	1806	43.35		A620
	1200	575	444T	<b>E405A</b>	444TTFS16582		20:1@	\$16,975	E9	95.0	94.5	1690	41.25		A229
125	3600	460	444TS	<b>E614</b>	444TSTFS6501	✓	2:1	\$16,295	E9	95.4	136	1725	37.50		A232
	3600	575	444TS	<b>E494</b>	444TSTFS6505		2:1	\$16,295	E9	95.4	109	1725	37.50		A232
	1800	460	444T	<b>E629</b>	444TTFS6536	✓	20:1@	\$14,469	E9	95.4	141	1725	41.25		A229
	1800	460	444TS	<b>E457</b>	444TSTFS6526	✓	20:1@	\$14,469	E9	95.4	141	1725	37.50		A232
	1800	575	444T	<b>E697</b>	444TTFS6540		20:1@	\$14,469	E9	95.4	113	1725	41.25		A229
	1200	460	445T	<b>E647</b>	445TTFN6586	✓	20:1@	\$18,975	E9	95.0	155	2000	43.26		A620
	1200	575	445T	<b>E406</b>	445TTFN6590		20:1@	\$18,975	E9	95.0	124	2000	43.26		A620
	150	3600	460	445TS	<b>E615</b>	445TSTFN6501	✓	2:1	\$19,574	E9	95.8	165	2187	39.44	
3600		575	445TS	<b>E495</b>	445TSTFN6502		2:1	\$19,574	E9	95.8	132	2187	39.44		A621
1800		460	445T	<b>E630</b>	445TTFN6536	✓	20:1@	\$16,822	E9	95.8	172	2070	43.26		A620
1800		460	445TS	<b>E458</b>	445TSTFN6526	✓	20:1@	\$16,822	E9	95.8	172	2070	39.44		A621
1800		575	445T	<b>E682</b>	445TTFN6537		20:1@	\$16,822	E9	95.8	138	2070	43.26		A620
1200		460	445T	<b>E448</b>	445TTFN6587	✓	20:1@	\$21,229	E9	95.8	180	2500	43.26	H, RB	N/A
1200		575	445T	<b>E407</b>	445TTFN6591		20:1@	\$21,229	E9	95.8	145	2500	43.26	RB	N/A
200		3600	460	445TS	<b>E449</b>	445TSTFN6505	✓	2:1	\$24,762	E9	95.8	222	2300	39.44	H
	3600	575	445TS	<b>E496</b>	445TSTFN6506		2:1	\$24,762	E9	95.8	178	2300	39.44		A621
	1800	460	445T	<b>E631</b>	445TTFN6538	✓	20:1@	\$20,459	E9	96.2	226	2437	43.26	RB	N/A
	1800	460	445TS	<b>E459</b>	445TSTFN6528	✓	20:1@	\$20,459	E9	96.2	226	2437	39.44	H	A621
	1800	460	447/9T	<b>E770</b>	449TTFS6530	✓	20:1@	\$23,528	E9	96.5	225	2700	51.69	H	A623
	1800	460	447/9T	<b>E854</b>	449TTFS6540	✓	20:1@	\$23,528	E9	96.5	225	2700	51.69	H, RB, d	N/A
	1800	575	447/9T	<b>E856</b>	449TTFS6564	✓	20:1@	\$23,528	E9	96.5	180	2700	51.69	H, RB, d	N/A
	1200	460	447/9T	<b>E773</b>	449TTFS6578	✓	20:1@	\$25,988	E9	95.8	240	2927	51.69	H	A623
	1200	460	447/9T	<b>E687</b>	449TTFS6588	✓	20:1@	\$25,988	E9	95.8	240	2927	51.69	H, RB	N/A
	1200	575	447/9T	<b>E408</b>	449TTFS6582		20:1@	\$25,988	E9	95.8	192	2927	51.69	H, RB	N/A
250	3600	460	447/9TS	<b>E699</b>	449TSTFS6503	✓	2:1	\$31,230	E9	95.8	275	2700	47.88	H, NE	A624
	1800	460	445T	<b>E450</b>	445TTFN6540		20:1@	\$25,668	E9	95.8	285	2450	43.26	H, NE, RB	N/A
	1800	460	447/9T	<b>E771</b>	449TTFS6528	✓	20:1@	\$29,517	E9	96.5	285	2830	51.69	H, NE	A623
	1800	460	447/9T	<b>E690</b>	449TTFS6538	✓	20:1@	\$29,517	E9	96.5	285	2830	51.69	H, NE, RB	N/A
	1200	460	L447/9T	<b>E774</b>	449TTFS6577		20:1@	\$29,874	E9	95.8	300	3415	51.69	H, NE	A623
	1200	460	L447/9T	<b>E688</b>	449TTFS6587		20:1@	\$29,874	E9	95.8	300	3415	51.69	H, NE, RB	N/A
	300	3600	460	447/9TS	<b>E698</b>	449TSTFS6502	✓	2:1	\$40,479	E9	96.2	330	2700	47.88	H, NE
1800		460	447/9T	<b>E691</b>	449TTFS6537	✓	20:1@	\$32,767	E9	96.5	339	3211	51.69	H, NE, RB	N/A
1800		460	447/9T	<b>E772</b>	449TTFS6527		20:1@	\$32,767	E9	96.5	339	3211	51.69	H, NE	A623
1800		575	447/9T	<b>E345</b>	449TTFS16534		20:1@	\$32,767	E9	96.5	271	3211	51.69	H, NE, RB	N/A
350	3600	460	447/9TS	<b>E769</b>	449TSTFS6501	✓	2:1	\$46,420	E9	95.8	380	3064	47.88	H, NE	A624
	1800	460	447/9T	<b>E692</b>	449TTFS6536	✓	20:1@	\$38,274	E9	96.2	395	3350	51.69	H, NE, RB	N/A
400	3600	460	5011S	<b>E369</b>	---		N/A	\$55,099	S6	95.8	432	5500	67.19	NE, 90	N/A
	1800	460	L447/9T	<b>E776</b>	449TTFS16553		2:1	\$39,295	E9	96.2	448	3800	56.71	H, NE, 79	N/A
	1200	460	5011LS	<b>E362</b>	---		N/A	\$68,918	S6	95.8	468	5500	67.19	NE, 77, 79, 90	N/A
450	1800	460	L447/9T	<b>E777</b>	---		N/A	\$40,177	E9	96.5	515	3800	56.71	H, NE, 79	N/A
	1200	460	5013LS	<b>E363</b>	5013LSTFS6595		N/A	\$91,917	S6	96.2	525	7200	67.19	A, NE, 77, 79, 90	N/A
500	1800	460	5011LS	<b>E364</b>	5011LSTFS16031		N/A	\$63,352	S6	96.2	555	5500	67.19	NE, 77, 79, 90	N/A
	1200	460	5013LS	<b>E365</b>	---		N/A	\$93,219	S6	96.2	580	7200	76.19	NE, 78, 79, 90	N/A
600	1800	460	5011LS	<b>E366</b>	5011LSTFS16033		N/A	\$75,063	S6	96.2	655	5500	67.19	A, NE, 77, 79, 90	N/A

Catalog numbers (Cat No.) highlighted in bold blue have efficiency levels that meet EISA requirements

Blue shaded areas are Cast Iron Frames

\* Requires nameplate modification  
@ Requires larger fan



# Blue Chip® Severe Duty / Automotive Duty NEMA Premium® XRI® IEEE-841 Totally Enclosed, Rigid Base, Three Phase



## Applications:

For extreme applications in the process industries such as chemical plants, pulp and paper mills, refineries, above-ground mines, food processing, foundries, and other severe duty environments where long life and ultra-high efficiency are required. Guaranteed efficiencies offer an eXtra Return on your Investment when using these premium efficiency motors on high cycle or long run time applications.

## Features:

- Meets or exceeds NEMA Premium® efficiencies, except where noted
- NEMA Premium® models are in compliance with EISA2007
- Meets IEEE-841 standard for severe duty applications
- Blue Chip® quality, 100% cast iron construction for rigidity and reduced vibration
- Inpro/Seal® VBX® bearing isolators on drive end shaft extension TENV and on both ends of TEFC
- Provisions to add stub shaft for an encoder (182T-449T, TEFC only)
- Internal and external epoxy paint
- MAX GUARD® Class F insulation system
- Constant Torque speed range is listed in CT SPEED RANGE column
- 1.15 Service Factor on sinewave, 1.0 Service Factor on IGBT power
- Bearing caps (254T and larger)
- Precision balanced to .08"/sec
- Extended grease tubes, regreasable in service
- Brass drain and breather
- Meets General Motors GM 7E-TA Automotive Duty Specification
- Meets IEEE45 USCG Marine Duty, API RPI4F for offshore platforms, IP56
- Meets NEMA MG1 - 1.26.6 Waterproof specification
- Hazardous Duty™ Division 2 CSA certification nameplate
- Division 2 / Zone 2 Class I (gases), Groups A, B, C, D
- Meets temperature code T2B
- Actual test and vibration data supplied with each motor
- Ball bearings (except as noted)
- UL Recognized (through 449T) and CSA Certified and CE Marked
- Five year warranty

Models through 40 HP are capable of modification as follows (contact factory to confirm):

- 1.25 Service Factor (sinewave only)
- 50HZ at same HP, 1.0 Service Factor (sinewave only)
- Any nameplate changes are subject to modification charges (see MOD Central Section)
- Contact Marathon Motors for optional nameplate markings on 50 HP and larger



Suitable for use on VFD per guidelines on page 17.

HP	RPM	VOLTS	FRAME	CAT. NO.	MODEL NO.	STOCK	CT SPEED RANGE*	LIST PRICE	MULT. SYMB.	NOM. EFF.	F.L. AMPS	WEIGHT	"C" DIM.	FOOT NOTES	C FACE KITS
1	1800	460	143T	W501	143THTN9026	√	1000:1	\$661	E9	85.5	1.5	55	10.43	75,76,N,NE	A181
	1800	575	143T	W502	143THTN19033		1000:1	\$661	E9	85.5	1.2	55	10.43	75,76,N,NE	A181
	1200	460	145T	W503	145THTN9076		1000:1	\$832	E9	80.0	1.65	60	11.43	75,76,N,NE	A262
	1200	575	145T	W638	145THTN19079		1000:1	\$832	E9	80.0	1.3	60	11.43	75,76,N,NE	A262
	900	460	182T	W504	182THFS19101		20:1	\$1,461	E9	74.0	2.2	81	15.19	75,NE	A182
1 1/2	3600	460	143T	W505	143THTN9001		1000:1	\$827	E9	86.5	2.0	58	10.43	75,76,N,NE	A181
	3600	575	143T	W506	143THTN9005		1000:1	\$827	E9	86.5	1.6	58	10.43	75,76,N,NE	A181
	1800	460	145T	W507	145THTN9026	√	1000:1	\$716	E9	84.0	2.2	65	11.43	75,76,N,NE	A262
	1800	575	145T	W508	145THTN19045		1000:1	\$716	E9	84.0	1.75	65	11.43	75,76,N,NE	A262
	1200	460	182T	W509	182THTS9076		1000:1	\$1,065	E9	87.5	2.2	100	12.71	75,N,NE	A182
2	3600	460	145T	W511	145THTN9001		1000:1	\$867	E9	85.5	2.5	68	11.43	75,76,N,NE	A262
	3600	575	145T	W512	145THTN19002		1000:1	\$867	E9	85.5	2.0	68	11.43	75,76,N,NE	A262
	1800	460	145T	W513	145THTN9027	√	1000:1	\$787	E9	85.5	3.0	68	11.43	75,76,N,NE	A262
	1800	575	145T	W514	145THTN19033		1000:1	\$787	E9	85.5	2.4	68	11.43	75,76,N,NE	A262
	1200	460	184T	W515	184THTS9076		1000:1	\$1,315	E9	88.5	3.0	112	13.71	75,N,NE	A182

Catalog numbers (Cat No.) highlighted in bold blue have efficiency levels that meet EISA requirements

Blue shaded areas are Cast Iron Frames

\* Requires nameplate modification

Continued on next page.

# Blue Chip® Severe Duty / Automotive Duty

## NEMA Premium® XRI® IEEE-841

Totally Enclosed, Rigid Base, Three Phase

SEVERE DUTY

HP	RPM	VOLTS	FRAME	CAT. NO.	MODEL NO.	STOCK	CT SPEED RANGE*	LIST PRICE	MULT. SYMB.	NOM. EFF.	F.L. AMPS	WEIGHT	"C" DIM.	FOOT NOTES	C FACE KITS	
3	3600	460	182T	W517	182THTS9001		1000:1	\$1,191	E9	87.5	3.8	105	12.71	75,N,NE	A182	
	1800	460	182T	W519	182THTS9026	√	1000:1	\$1,068	E9	90.2	4.0	100	12.71	75,N,NE	A182	
	1800	575	182T	W520	182THTS19033		1000:1	\$1,068	E9	90.2	3.2	100	12.71	75,N,NE	A182	
	1200	460	213T	W521	213THFS9076	√	20:1	\$1,620	E9	89.5	4.4	176	18.22	75	A183	
3	900	460	215T	W522	215THFS9101		20:1	\$2,426	E9	86.5	5.0	180	19.72	75,NE	A183	
	5	3600	460	184T	W523	184THFS9001	√	2:1	\$1,323	E9	89.5	5.9	142	16.19	75	A182
5	3600	575	184T	W524	184THFS19006		2:1	\$1,323	E9	89.5	4.7	142	16.19	75	A182	
	1800	460	184T	W525	184THFS9026	√	20:1	\$1,238	E9	90.2	6.2	130	16.19	75	A182	
	1800	575	184T	W526	184THFS9030	√	20:1	\$1,238	E9	90.2	5.0	130	16.19	75	A182	
	1200	460	215T	W527	215THFS9076	√	20:1	\$1,988	E9	89.5	6.9	202	19.72	75	A183	
	1200	575	215T	W528	215THFS19077		20:1	\$1,988	E9	89.5	5.5	202	19.72	75	A183	
	900	460	254T	W529	254THFNA9101		10:1	\$3,162	E9	88.5	7.5	375	23.52	75,NE	A184	
	7 1/2	3600	460	213T	W530	213THTS9001	√	2:1	\$1,598	E9	91.7	8.9	200	17.18	75,N	A183
	3600	575	213T	W531	213THTS19005		2:1	\$1,598	E9	91.7	7.1	200	17.18	75,N	A183	
7 1/2	1800	460	213T	W532	213THFS9026	√	20:1	\$1,517	E9	91.7	9.6	200	19.73	75	A183	
	1800	575	213T	W533	213THFS9030	√	20:1	\$1,517	E9	91.7	7.7	200	19.72	75	A183	
	1200	460	254T	W534	254THFNA9076	√	20:1	\$2,287	E9	91.0	9.9	326	23.52	75	A184	
	900	460	256T	W536	256THFNA9101		20:1	\$3,921	E9	88.5	11.0	425	25.27	75,NE	A184	
	10	3600	460	215T	W537	215THFS9001	√	2:1	\$1,866	E9	91.7	11.9	218	19.72	75	A183
	3600	575	215T	W538	215THFS19006		2:1	\$1,866	E9	91.7	9.5	218	19.72	75	A183	
	1800	460	215T	W539	215THFS9026	√	20:1	\$1,827	E9	91.7	12.5	225	19.72	75	A183	
10	1800	575	215T	W540	215THFS19033	√	20:1	\$1,827	E9	91.7	10.0	225	19.73	75	A183	
	1200	460	256T	W541	256THFNA9076	√	20:1	\$2,915	E9	91.0	13.1	405	25.27	75	A184	
	1200	575	256T	W542	256THFNA19081		20:1	\$2,915	E9	91.0	10.5	405	25.27	75	A184	
	900	460	284T	W543	284THFNA19102		20:1	\$4,767	E9	90.2	16.0	550	27.88	NE	A186	
	15	3600	460	254T	W544	254THFNA9001	√	20:1	\$2,314	E9	91.7	17.5	345	23.52		A184
	1800	460	254T	W546	254THFNA9026	√	20:1	\$2,173	E9	92.4	18.8	350	23.52		A184	
	1800	460	254T	W546-P	254THFNA19065	√	20:1	\$2,499	E9	92.4	18.8	350	23.52	P	A184	
15	1800	575	254T	W547	254THFNA9030	√	20:1	\$2,173	E9	92.4	15.1	350	23.52		A184	
	1200	460	284T	W548	284THFNA9076	√	20:1	\$3,870	E9	91.7	20.4	479	27.88		A186	
	1200	575	284T	W549	---		20:1	\$3,870	E9	91.7	16.3	479	26.34		A186	
	900	460	286T	W550	286THFNA19101	√	20:1	\$5,980	E9	90.2	22.0	575	27.84	NE	A186	
	20	3600	460	256T	W551	256THFNA9001	√	2:1	\$2,868	E9	92.4	23.4	375	25.27	75	A184
	1800	460	256T	W553	256THFNA9026	√	20:1	\$2,708	E9	93.0	24.1	425	25.27	75	A184	
	1800	460	256T	W553-P	256THFNA19056	√	20:1	\$3,114	E9	93.0	24.1	425	25.27	75,P	A184	
20	1800	575	256T	W554	256THFNA19033	√	20:1	\$2,708	E9	93.0	19.3	425	25.27	75	A184	
	1200	460	286T	W555	286THFNA9076	√	20:1	\$4,714	E9	91.7	26.8	550	27.84		A186	
	1200	575	286T	W556	286THFNA19077		20:1	\$4,714	E9	91.7	21.4	550	27.84		A186	
	25	3600	460	284TS	W558	284TSHFNA9001	√	2:1	\$3,533	E9	93.6	28.1	481	24.97		A186
	3600	575	284TS	W559	284TSHFNA9005		2:1	\$3,533	E9	93.6	22.4	481	24.97		A186	
	1800	460	284T	W560	284THFNA9026	√	20:1	\$3,223	E9	93.6	31.0	478	26.44		A186	
	1800	460	284T	W560-P	284THFNA19048	√	20:1	\$3,706	E9	93.6	31.0	478	26.44	P	A186	
25	1800	575	284T	W561	284THFNA19033	√	20:1	\$3,223	E9	93.6	24.8	478	26.34		A186	
	1200	460	324T	W562	324THFS9076	√	20:1	\$5,715	E9	93.0	32.5	675	28.87		A187	
	1200	575	324T	W563	324THFS9080		20:1	\$5,715	E9	93.0	26.0	675	28.87		A187	
	30	3600	460	286TS	W565	286TSHFNA9001	√	2:1	\$4,126	E9	93.6	33.8	500	26.44		A186
	1800	460	286T	W567	286THFNA9026	√	20:1	\$3,749	E9	94.1	36.5	525	27.84		A186	
	1800	460	286T	W567-P	286THFNA19066	√	20:1	\$4,311	E9	94.1	36.5	525	27.84	P	A186	
	1800	575	286T	W568	286THFNA19033		20:1	\$3,749	E9	94.1	29.2	525	27.84		A186	
30	1200	460	326T	W569	326THFS9076	√	20:1@	\$6,582	E9	93.0	38.5	725	30.37		A187	
	1200	575	326T	W643	326THFS19078		20:1@	\$6,582	E9	93.0	31.0	725	30.37		A187	

Catalog numbers (Cat No.) highlighted in bold blue have efficiency levels that meet EISA requirements

Blue shaded areas are Cast Iron Frames

\* Requires nameplate modification

@ Requires larger fan

Continued on next page.

# Blue Chip® Severe Duty / Automotive Duty

## NEMA Premium® XRI® IEEE-841

Totally Enclosed, Rigid Base, Three Phase

SEVERE DUTY

HP	RPM	VOLTS	FRAME	CAT. NO.	MODEL NO.	STOCK	CT SPEED RANGE*	LIST PRICE	MULT. SYMB.	NOM. EFF.	F.L. AMPS	WEIGHT	"C" DIM.	FOOT NOTES	C FACE KITS
40	3600	460	324TS	<b>W571</b>	324TSHFS9001	✓	2:1	\$5,441	E9	93.6	47.0	656	27.37		A187
	1800	460	324T	<b>W573</b>	324THFS9026	✓	20:1@	\$4,978	E9	94.1	47.5	700	28.87		A187
	1800	460	324T	<b>W573-P</b>	324THFS19058	✓	20:1@	\$5,725	E9	94.1	47.5	700	28.87	P	A187
	1800	575	324T	<b>W574</b>	324THFS19033		20:1@	\$4,978	E9	94.1	38.0	700	30.37		A187
	1200	460	364T	<b>W575A</b>	364THFS19087	✓	20:1@	\$8,207	E9	94.1	50.0	950	31.50		A188
	1200	575	364T	<b>W639</b>	364THFS19077		20:1@	\$8,207	E9	94.1	40.0	950	31.50		A188
	900	460	365T	W576	365THFS19101		20:1@	\$11,701	E9	91.7	53.0	975	32.50	NE	A188
50	3600	460	326TS	<b>W577</b>	326TSHFS9001	✓	2:1	\$7,038	E9	93.6	58.0	725	28.87		A187
	3600	575	326TS	<b>W578</b>	326TSHFS9005		2:1	\$7,038	E9	93.6	46.5	725	28.87		A187
	1800	460	326T	<b>W580</b>	326THFS9026	✓	2:1	\$6,115	E9	94.5	60.0	775	30.37		A187
	1800	460	326T	<b>W580-P</b>	326THFS19071	✓	20:1@	\$7,032	E9	94.5	60.0	775	30.37	P	A187
	1800	460	326TS	<b>W579</b>	326TSHFS9036		2:1	\$6,115	E9	94.5	60.0	775	28.87		A187
	1800	575	326T	<b>W581</b>	326THFS19033		2:1	\$6,115	E9	94.5	48.0	775	30.37		A187
	1200	460	365T	<b>W582A</b>	365THFS19086	✓	20:1@	\$10,066	E9	94.5	61.5	942	32.50		A188
	1200	575	365T	<b>W640</b>	365THFS19077		20:1@	\$10,166	E9	94.5	49.0	983	31.50		A188
	900	460	404T	W583	404THFS9101		20:1@	\$13,166	E9	93.6	66.0	1264	35.62	NE	A190
60	3600	460	364TS	<b>W584</b>	364TSHFS9001	✓	2:1	\$8,519	E9	94.5	67.0	925	29.38		A189
	1800	460	364T	<b>W587</b>	364THFS9036	✓	20:1@	\$8,070	E9	95.0	69.0	1000	31.50		A188
	1800	460	364T	<b>W587-P</b>	364THFS19061	✓	20:1@	\$8,716	E9	95.0	69.0	1000	31.50	P	A188
	1800	460	364TS	<b>W586</b>	364TSHFS9026		20:1@	\$8,070	E9	95.0	69.0	1000	29.38		A189
	1800	575	364T	<b>W588</b>	364THFS19033		20:1@	\$8,070	E9	95.0	55.0	1000	31.50		A188
	1200	460	404T	<b>W589</b>	404THFS9086		20:1@	\$11,043	E9	94.5	72.0	1156	35.62		A190
	900	460	405T	W590	405THFS19101		20:1@	\$14,773	E9	93.6	80.0	1350	37.12	NE	A190
75	3600	460	365TS	<b>W591</b>	365TSHFS9001	✓	2:1	\$10,697	E9	94.5	84.0	1002	30.38		A189
	3600	575	365TS	<b>W592</b>	365TSHFS19002		2:1	\$10,697	E9	94.5	67.0	1002	30.38		A189
	1800	460	365T	<b>W594</b>	365THFS9036	✓	20:1@	\$10,231	E9	95.4	86.0	1100	32.50		A188
	1800	460	365T	<b>W594-P</b>	365THFS19065	✓	20:1@	\$11,147	E9	95.4	86.0	1100	32.50	P	A188
	1800	460	365TS	<b>W593A</b>	365TSHFS19034		20:1@	\$10,231	E9	95.4	86.0	1100	30.38		A189
	1800	575	365T	<b>W595</b>	365THFS9044	✓	20:1@	\$10,231	E9	95.4	69.0	1100	32.50	d	A188
	1200	460	405T	<b>W596</b>	405THFS9086		20:1@	\$12,998	E9	95.0	90.0	1280	37.12		A190
	900	460	444T	W597	444THFS9101		20:1@	\$19,643	E9	93.6	100	1734	41.25	NE	A192
100	3600	460	405TS	<b>W598</b>	405TSHFS9001	✓	2:1	\$14,334	E9	95.0	108	1295	34.12		A191
	1800	460	405T	<b>W600</b>	405THFS9036	✓	20:1@	\$12,640	E9	95.4	113	1330	37.12		A190
	1800	460	405T	<b>W600-P</b>	405THFS19327	✓	20:1@	\$13,651	E9	95.4	113	1330	37.12	P	A190
	1800	460	405TS	<b>W599</b>	405TSHFS9026		20:1@	\$12,640	E9	95.4	113	1330	34.12		A191
	1800	575	405T	<b>W601</b>	405THFS9040	✓	20:1@	\$12,640	E9	95.4	90.0	1330	37.12	d	A190
	1200	460	444T	<b>W636</b>	444THFN19081		20:1@	\$19,168	E9	95.0	124	2100	41.25		A194
	900	460	445T	W603	445THFN9106		20:1@	\$24,072	E9	94.1	142	2350	43.19	NE	A194
125	3600	460	444TS	<b>W604A</b>	444TSHFN19002		2:1	\$18,740	E9	95.0	142	1682	39.64		A193
	1800	460	444T	<b>W606</b>	444THFS9036	✓	20:1@	\$16,640	E9	95.4	141	1725	41.25		A192
	1800	460	444T	<b>W606-P</b>	444THFN19044	✓	20:1@	\$17,971	E9	95.4	141	1725	41.25	P	A194
	1800	575	444T	<b>W607</b>	444THFS9040	✓	20:1@	\$16,640	E9	95.4	113	1725	41.25		A192
	1200	460	445T	<b>W608</b>	445THFN9086		20:1@	\$21,820	E9	95.0	155	2000	43.19		A194
	900	460	445T	W609	445THFN9102		20:1@	\$24,724	E9	94.5	172	2515	43.19	NE	A194
	150	3600	460	445TS	<b>W610</b>	445TSHFN9001		2:1	\$22,511	E9	95.8	165	2187	39.37	
1800		575	445TS	<b>W611</b>	445TSHFN9026	✓	20:1@	\$19,345	E9	95.8	172	2070	39.37	d	A194
1800		460	445T	<b>W612</b>	445THFN9036	✓	20:1@	\$19,345	E9	95.8	172	2070	43.19		A194
1800		460	445T	<b>W612-P</b>	445THFN19071	✓	20:1@	\$20,892	E9	95.8	172	2070	43.19	P	A194
1800		575	445T	<b>W641</b>	445THFN19033		20:1@	\$19,345	E9	95.8	138	2070	43.19	RB	A194
1800		575	445T	<b>W613</b>	445THFN9037		20:1@	\$19,345	E9	95.8	138	2070	43.19		A194
1200		460	445T	<b>W614</b>	445THFN9087		20:1@	\$24,415	E9	95.8	181	2500	43.19	H,RB	A194
900		460	L447/9T	W615	449THFS9101		20:1@	\$31,445	E9	95.4	205	3150	51.88	NE	N/A

Catalog numbers (Cat No.) highlighted in bold blue have efficiency levels that meet EISA requirements

Blue shaded areas are Cast Iron Frames

\* Requires nameplate modification

@ Requires larger fan

Continued on next page.

# Blue Chip® Severe Duty / Automotive Duty NEMA Premium® XRI® IEEE-841

## Totally Enclosed, Rigid Base, Three Phase

HP	RPM	VOLTS	FRAME	CAT. NO.	MODEL NO.	STOCK	CT SPEED RANGE*	LIST PRICE	MULT. SYMB.	NOM. EFF.	F.L. AMPS	WEIGHT	"C" DIM.	FOOT NOTES	C FACE KITS
200	3600	460	445TS	<b>W616</b>	445TSHFN9005		2:1@	\$28,477	E9	95.8	223	2300	39.37	H,SL	A195
	1800	460	445T	<b>W618</b>	445THFN9038		20:1@	\$23,528	E9	96.2	226	2437	43.19	RB	A194
	1800	460	445T	<b>W618-P</b>	445THFN19070	√	20:1@	\$25,410	E9	96.2	226	2437	43.19	P	A194
	1800	460	445TS	<b>W617</b>	445TSHFN9028		20:1@	\$23,528	E9	96.2	226	2700	39.37		A195
	1800	460	447/9T	<b>W619</b>	449THFS9030		20:1@	\$27,056	E9	96.5	225	2700	51.69		N/A
	1800	575	445T	<b>W642</b>	445THFN19034	√	20:1@	\$27,056	E9	96.2	181	2437	43.19		A194
	1200	460	447/9T	<b>W621</b>	449THFS19092		20:1@	\$29,886	E9	95.8	225	2927	51.84		N/A
	1200	460	447/9T	<b>W622</b>	449THFS9088		20:1@	\$29,886	E9	95.8	240	2927	51.69	RB	N/A
	1200	575	447/449T	<b>W630</b>	449THFS19079		20:1@	\$29,886	E9	95.8	192	2927	51.69	RB	N/A
250	3600	460	447/9TS	<b>W624</b>	449TSHFS9003		2:1	\$35,914	E9	96.5	2700	2700	47.94		N/A
	1800	460	447/9T	<b>W626</b>	449THFS9028		20:1@	\$33,946	E9	96.5	2830	2830	51.69		N/A
	1800	460	447/9T	<b>W626-P</b>	449THFS19342	√	20:1@	\$36,662	E9	96.5	285	2830	51.69	P	N/A
300	1800	460	447/9T	<b>W632</b>	449THFS9027		20:1@	\$34,625	E9	96.5	3211	3211	51.84		N/A
350	3600	460	447/9TS	<b>W634</b>	449TSHFS9001		2:1	\$53,384	E9	96.2	3064	3064	47.94	SL	N/A
	1800	460	447/9T	<b>W635</b>	449THFS9036		2:1	\$44,015	E9	96.2	3350	3350	51.84	RB,SL	N/A

Catalog numbers (Cat No.) highlighted in bold blue have efficiency levels that meet EISA requirements

Blue shaded areas are Cast Iron Frames

\* Requires nameplate modification  
@ Requires larger fan

# Hazardous Duty™ Division 1 Explosion Proof Class I and II, Groups D, F & G

Blue Chip® Severe Duty, NEMA Premium Efficiency, Three Phase

## Features:

- 10:1 Variable torque, see Inverter Duty column for constant torque
- CR200 Corona Resistant, 200°C rated magnet wire
- 1.15 Service Factor
- Normally closed thermostats (must be connected to control circuit)
- Meets temperature code T3B
- All cast iron construction • External surface treated with epoxy paint
- Nameplated 60/50 hertz, 190/380 Volts, at next lower horsepower as noted
- UL Listed
- CSA Certified File No. LR47504
- Two year warranty



EXPLOSION PROOF

**IP54**

## C-Face Footed (Rigid Base)

HP	RPM	VOLTS	FRAME	CAT. NO.	MODEL NO.	STOCK	CT SPEED RANGE*	LIST PRICE	MULT. SYMB.	NOM. EFF.	F.L. AMPS	WEIGHT	"C" DIM.	FOOT NOTES
1	1800	208-230/460	143TC	<b>C361A</b>	143TTGN6551	√	10:1	\$886	E7	85.5	3.0-3.0/1.5	72	15.23	80
1 1/2	1800	208-230/460	145TC	<b>C362A</b>	145TTGN6536	√	10:1	\$938	E7	86.5	4.7-4.6/2.3	88	15.23	80
2	1800	208-230/460	145TC	<b>C363A</b>	145TTGN6549	√	10:1	\$986	E7	86.5	6.2-6.0/3.0	90	15.23	80
3	1800	208-230/460	182TC	<b>C364A</b>	182TTGN6569	√	10:1	\$1,146	E7	89.5	8.4-8.0/4.0	154	16.62	
	1800	575	182TC	<b>C368A</b>	182TTGN6536	√	10:1	\$1,146	E7	89.5	3.2	158	16.62	
5	1800	208-230/460	184TC	<b>C365A</b>	184TTGN6575	√	10:1	\$1,249	E7	89.5	13.8-12.4/6.2	168	18.62	
	1800	575	184TC	<b>C369A</b>	184TTGN6537	√	10:1	\$1,249	E7	89.5	5.0	167	18.62	
7 1/2	1800	208-230/460	213TC	<b>C366A</b>	213TTGN6528	√	10:1	\$1,698	E7	91.7	20.8-19.2/9.6	255	20.45	
	1800	575	213TC	<b>C370A</b>	213TTGN6536	√	10:1	\$1,698	E7	91.7	7.7	275	20.45	
10	1800	208-230/460	215TC	<b>C367A</b>	215TTGN6528	√	2:1	\$1,953	E7	91.7	27.0-25.0/12.5	228	23.45	
	1800	575	215TC	<b>C371A</b>	215TTGN16534		2:1	\$1,953	E7	91.7	10.0	201	23.45	

Catalog numbers (Cat No.) highlighted in bold blue have efficiency levels that meet EISA requirements

Blue shaded areas are Cast Iron Frames

# Hazardous Duty™ Division 1 Explosion Proof Class I and II, Groups C, D, E (as noted), F & G

## Steel Frame, Standard and NEMA Premium Efficiencies, Three Phase

### Features:

- 1.0 Service Factor (except as noted)
- Meets temperature code T3B
- Explosion proof conduit box included, shipped loose
- UL Listed File No. E12044
- CSA Certified File No. LR47504
- K717 is rated for Class I Group D, Class II Groups F&G only
- Automatic Overload (except as noted)



EXPLOSION PROOF

### Rigid Base

HP	RPM	VOLTS	FRAME	GROUP E	CAT. NO.	MODEL NO.	STOCK	LIST PRICE	MULT. SYMB.	NOM. EFF.	F.L. AMPS	WEIGHT	"C" DIM.	FOOT NOTES
1/4	1800	230/460	48	N	K717	5K32GNB249	✓	\$578	F1	62.5	1.2/0.6	19	9.68	
	1800	208-230/460	56	N	G646	56T17E5308	✓	\$545	F1	71.0	1.1-1.1/55	25	11.97	N
	1800	575	56	N	G664	56T17E5314	✓	\$545	F1	71.0	0.43	25	11.97	N
1/3	1800	208-230/460	56	N	G647	56T17E5309	✓	\$580	F1	74.0	1.3-1.2/.60	25	11.97	N
	1800	575	56	N	G665	56T17E5315		\$580	F1	74.0	0.5	25	11.97	N
	1200	230/460	56	N	K2101	5K49FN6381	✓	\$783	F1	62.0	2.2/1.1	29	13.44	
1/2	3600	208-230/460	56	N	G648	56T34G5303		\$533	F1	66.5	2.1-2.4/1.2	30	13.44	
	1800	208-230/460	56	N	K2103	5K49JN4560	✓	\$613	F1	68.0	2.2-2.4/1.2	29	13.94	d
	1800	208-230/460	56	N	G649	56T17G5312	✓	\$613	F1	68.0	2.3-2.4/1.2	28	13.94	
	1800	200	56	N	K2102	5K49JN4582		\$701	F1	68.0	2.75	29	13.94	
	1800	575	56	N	G666	56T17G5321	✓	\$613	F1	68.0	1.0	28	13.94	
3/4	1200	230/460	56	N	K2104	5K49HN6385	✓	\$825	F1	68.0	2.7/1.35	34	13.44	
	3600	208-230/460	56	N	G660	56T34G5304		\$585	F1	74.0	3.0-3.2/1.6	30	13.44	
	1800	208-230/460	56	N	G661	56T17G5313	✓	\$647	F1	75.5	2.9-3.0/1.5	30	13.94	
	1800	200	56	N	K2105	5K49JN4574		\$747	F1	75.5	3.45	31	13.94	
	1800	575	56	N	G667	56T17G5322	✓	\$647	F1	75.5	1.2	29	13.94	
1	1200	208-230/460	143T	N	K2107	5K49MN8349	✓	\$883	F1	74.0	3.2-3.2/1.6	42	14.00	
	1200	208-230/460	56	N	K2116	5K49MN6382	✓	\$878	F1	74.0	3.2-3.2/1.6	42	13.94	
	3600	208-230/460	56	N	G662	56T34G5305	✓	\$621	F1	74.0	3.9-3.6/1.8	28	13.44	
	1800	208-230/460	56	N	G663	56T17G5314	✓	\$653	F1	77.0	3.5-3.6/1.8	31	13.94	
	1800	208-230/460	143T	Y	<b>I502</b>	143TTGR16026	✓	\$1,016	E7	85.5	3.3-3.3/1.65	48	16.00	TS
	1800	575	56	N	G668	56T17G5323	✓	\$653	F1	77.0	1.45	31	13.94	
	1800	575	143T	Y	<b>I503</b>	143TTGR16030		\$1,016	E7	85.5	1.3	48	16.00	A,TS
1 1/2	1200	230/460	56H	N	K2110	5K49TN6383	✓	\$921	F1	77.0	3.4/1.7	47	15.50	
	1200	208-230/460	145T	Y	<b>I504</b>	145TTGR16076	✓	\$1,230	E7	82.5	3.8-3.8/1.9	58	16.50	TS
	1200	575	145T	Y	<b>I505</b>	145TTGR16080		\$1,230	E7	82.5	1.5	58	16.50	TS
	3600	208-230/460	143T	Y	<b>I506</b>	143TTGR16001	✓	\$941	E7	84.0	4.0/2.0	38	14.50	TS
	3600	575	143T	Y	<b>I507</b>	143TTGR16005	✓	\$941	E7	84.0	1.6	38	14.50	TS
	1800	208-230/460	56H	N	K2111	5K49NN4580	✓	\$823	F1	80.0	4.8-4.8/2.4	42	14.08	
	1800	208-230/460	145T	Y	<b>I508</b>	145TTGR16038	✓	\$963	E7	86.5	4.7-4.6/2.3	42	16.00	TS
2	1800	575	145T	Y	<b>I509</b>	145TTGR16030	✓	\$963	E7	86.5	1.85	42	16.00	A,TS
	3600	208-230/460	145T	Y	<b>I512</b>	145TTGR16002	✓	\$1,411	E7	85.5	5.6-5.0/2.5	47	16.50	TS
	3600	575	145T	Y	<b>I513</b>	145TTGR16004	✓	\$1,411	E7	85.5	2.0	47	16.50	TS
	1800	208-230/460	145T	Y	<b>I514</b>	145TTGR16040	✓	\$1,176	E7	86.5	6.0-5.6/2.8	55	16.50	A,TS
	1800	575	145T	Y	<b>I515</b>	145TTGR16039	✓	\$1,176	E7	86.5	2.4	55	16.50	A,TS

Catalog numbers (Cat No.) highlighted in bold blue have efficiency levels that meet EISA requirements

# Hazardous Duty™ Division 1 Explosion Proof Class I and II, Groups C, D, F & G

## Severe Duty, Standard and EPart Efficiencies, Three Phase

<b>Features:</b>	<b>56 Frame</b>	<b>143-256TC</b>
Frame Construction	Rolled Steel	Cast Iron "Blue Chip"
Thermal Protection	Auto Overload	T-Stats
Class/Group	Class I, Groups C & D, Class II, Groups F & G	Class I, Group D Class II, Groups F & G
Temperature Code	T3B	T3B
Conduit Box	Shipped Loose	Installed
Service Factor	1.0 (unless otherwise noted)	1.0 (unless otherwise noted)
UL File	E12044	E12044
CSA File	LR47504	LR47504



EXPLOSION PROOF

### C-Face Footless

HP	RPM	VOLTS	FRAME	CAT. NO.	MODEL NO.	STOCK	CT SPEED RANGE*	LIST PRICE	MULT. SYMB.	NOM. EFF.	F.L. AMPS	WEIGHT	"C" DIM.	FOOT NOTES
1/4	1800	208-230/460	56C	G827	56T17E5310	✓	----	\$512	F1	71.0	1.1-1.1/0.55	25	11.97	CD,N
	1800	575	56C	G842	56T17E5312		----	\$512	F1	71.0	0.43	25	11.97	CD,N
1/3	1800	208-230/460	56C	G828	56T17E5311	✓	----	\$541	F1	74.5	1.3-1.2/0.6	25	11.97	CD,N
	1800	575	56C	G843	56T17E5313	✓	----	\$541	F1	74.5	0.50	25	11.97	CD,N
1/2	1800	208-230/460	56C	G829	56T17G5315	✓	----	\$570	F1	68.0	2.3-2.4/1.2	28	13.94	CD
	1800	208-230/460	56C	K2112	5K49JN4576	✓	----	\$570	F1	68.0	2.3-2.4/1.2	29	13.94	d,CD
	1800	575	56C	G844	56T17G5318		----	\$570	F1	68.0	1.0	32	13.94	CD
3/4	1800	208-230/460	56C	G840	56T17G5316	✓	----	\$601	F1	75.5	2.9-3.0/1.5	29	13.94	CD
	1800	575	56C	G845	56T17G5319	✓	----	\$601	F1	75.5	1.2	29	13.94	CD
1	1800	208-230/460	56C	G841	56T17G5317	✓	----	\$608	F1	77.0	3.5-3.6/1.8	30	13.94	CD
	1800	575	56C	G846	56T17G5320	✓	----	\$608	F1	77.0	1.45	32	13.94	CD
	1800	208-230/460	143TC	<b>C320A</b>	143TTGN4062	✓	10:1	\$748	E7	82.5	3.4-3.6/1.8	55	15.18	18,68
1 1/2	3600	208-230/460	143TC	<b>C301A</b>	143TTGN4020		10:1	\$777	E7	82.5	4.6-4.4/2.2	54	15.18	18,68
	1800	208-230/460	56C	K2115	5K49NN4581		----	\$868	F1	80.0	4.8-4.8/2.4	38	14.44	18,CD
	1800	208-230/460	145TC	<b>C321A</b>	145TTGN4337	✓	10:1	\$791	E7	84.0	4.6-4.4/2.2	60	15.18	18,68
2	3600	208-230/460	145TC	<b>C302A</b>	145TTGN4022		2:1	\$844	E7	84.0	5.6-5.4/2.7	59	13.98	18,68
	1800	208-230/460	145TC	<b>C322A</b>	145TTGN4338	✓	10:1	\$834	E7	84.0	6.0-5.6/2.8	69	15.18	18,68
3	3600	208-230/460	182TC	<b>C303A</b>	182TTGN4315	✓	10:1	\$928	E7	85.5	8.4-7.4/3.7	119	18.62	68
	1800	230/460	182TC	<b>C323A</b>	182TTGN4068	✓	2:1	\$992	E7	87.5	8.8-8.0/4.0	112	18.62	68
5	3600	208-230/460	184TC	<b>C304A</b>	184TTGN4313	✓	2:1	\$1,165	E7	87.5	12.4-11.8/5.9	133	18.62	68
	1800	230/460	184TC	<b>C324A</b>	184TTGN4072	✓	2:1	\$1,078	E7	87.5	14.7-13/6.5	132	18.62	68
7 1/2	3600	230/460	213TC	<b>C305</b>	213TTGS14015	✓	2:1	\$1,543	E7	88.5	19.0/9.5	241	22.25	68
	1800	208-230/460	213TC	<b>C325A</b>	213TTGN4067	✓	2:1	\$1,474	E7	89.5	22.0-20.0/10.0	194	23.45	68
10	3600	230/460	215TC	<b>C306</b>	215TTGS14020	✓	2:1	\$1,703	E7	90.2	24.0/12.0	271	22.25	68
	1800	208-230/460	215TC	<b>C326A</b>	215TTGN4065	✓	2:1	\$1,688	E7	89.5	27.2-25.0/12.5	216	23.45	68
15	3600	230/460	254TC	<b>C307A</b>	254TTGP14013	✓	2:1	\$2,210	E7	90.2	35/17.5	331	24.19	68
	1800	230/460	254TC	<b>C327A</b>	254TTGN14042	✓	2:1	\$2,176	E7	91.0	39/19.5	370	25.77	68
20	3600	230/460	256TC	<b>C308A</b>	256TTGN14011		2:1	\$2,654	E7	90.2	47.0/23.5	340	25.77	68
	1800	208-230/460	256TC	<b>C328A</b>	256TTGN14044	✓	2:1	\$2,721	E7	91.0	50.0/25.0	315	25.94	68

Catalog numbers (Cat No.) highlighted in bold blue have efficiency levels that meet EISA requirements

Blue shaded areas are Cast Iron Frames

# Hazardous Duty™ Division 1 Explosion Proof Class I and II, Groups C (as noted), D, F & G Blue Chip® Severe Duty, EAct Efficiency, Three Phase

## Features:

- 1.15 Service Factor on sinewave
- 10:1 Variable torque, constant torque speed range as indicated @1.0 SF
- Class F insulation
- CR200 Corona Resistant, 200°C rated magnet wire
- Ball Bearings (except as noted)
- All cast iron construction
- Normally closed thermostats (must be connected to control circuit)
- Meets temperature code T3B
- Shaft slinger
- External surface treated with epoxy
- See Modification section for addition of C-Face Kits (254T-445T)
- Meets IEEE45 USCG Marine Duty, IP 54 construction
- Contact Marathon Motors for F2 mounting
- UL Listed File No. E12044
- CSA Certified File No. LR47504,
- Two year warranty



## Rigid Base

HP	RPM	VOLTS	FRAME	GROUP C	CAT. NO.	MODEL NO.	STOCK	CT SPEED RANGE	LIST PRICE	MULT. SYMB.	NOM. EFF.	F.L. AMPS	WEIGHT	"C" DIM.	FOOT NOTES
1	1800	575	143T	N	<b>U020</b>	143TTGN4030		10:1	\$691	E7	82.5	1.2	62	13.48	25,80
1 1/2	1800	575	145T	N	<b>U021</b>	145TTGN4035		10:1	\$737	E7	84.0	1.8	74	14.73	25,80
2	1800	575	145T	N	<b>U022</b>	145TTGN4040		10:1	\$780	E7	85.5	2.4	78	14.73	25,80
3	1800	575	182T	N	<b>U023</b>	182TTGS4030		10:1	\$890	E7	87.5	3.4	128	16.19	25
5	1800	575	184T	N	<b>U024</b>	184TTGS4030		10:1	\$976	E7	86.5	5.2	142	17.44	25
7 1/2	1800	575	213T	N	<b>U025</b>	213TTGS4030		10:1	\$1,321	E7	89.5	8.0	221	19.66	25
10	1800	575	215T	N	<b>U026</b>	215TTGS4030		2:1	\$1,540	E7	89.5	10.0	225	20.91	25
15	1800	575	254T	Y	<b>U027</b>	254TTGN4030		10:1	\$1,974	E7	91.0	15.6	365	23.52	
20	1800	575	256T	Y	<b>U028</b>	256TTGN4030		2:1	\$2,362	E7	91.0	20.0	379	25.27	
25	1800	575	284T	Y	<b>U029</b>	284TTGP4030		2:1	\$3,005	E7	92.4	24.8	325	26.26	
30	1800	575	286T	Y	<b>U030</b>	286TTGP4030		2:1	\$3,484	E7	92.4	29.6	496	27.76	87
40	1800	575	324T	Y	<b>U031</b>	324TTGP4030		2:1	\$4,639	E7	93.0	40.0	520	28.97	17,87
50	1800	575	326T	Y	<b>U032</b>	326TTGP4030		2:1	\$5,647	E7	93.0	49.0	520	30.47	17,87
60	1800	575	364T	Y	<b>U033</b>	364TTGS4040		2:1	\$8,204	E7	93.6	57.5	1055	31.5	87
75	1800	575	365T	Y	<b>U034</b>	365TTGS4040		2:1	\$10,094	E7	94.1	71.0	1094	32.5	87
100	1800	575	405T	Y	<b>U035</b>	405TTGS4040		2:1	\$12,412	E7	94.5	91.0	1365	37.12	87
125	1800	575	444T	Y	<b>U036</b>	444TTGS4042		2:1	\$16,030	E7	94.5	113.0	1808	41.25	87
150	1800	575	445T	Y	<b>U037</b>	445TTGN4030		10:1	\$19,798	E7	95.0	138.0	2236	43.19	
200	1800	575	445T	Y	<b>U038</b>	445TTGN4045		2:1	\$22,400	E7	95.0	180.0	2384	43.19	RB,87

Catalog numbers (Cat No.) highlighted in bold blue have efficiency levels that meet EISA requirements

Blue shaded areas are Cast Iron Frames



# Hazardous Duty™ Division 1 Explosion Proof, NEMA Premium® XRI®, Class I and II, Groups C, D, F & G Blue Chip® Severe Duty, Three Phase

## Features:

### ✔ Meets NEMA Premium® efficiencies

- 10:1 Variable torque, see Inverter Duty column for constant torque
- MAX GUARD® Class F insulation
- Blue Chip® quality, 100% cast iron construction for rigidity and reduced vibration
- Internal and external surfaces treated with epoxy paint
- 1.15 Service Factor on sinewave or 1.0 Service Factor on IBGT power
- Precision balanced to .08"/sec.
- Extended grease tubes
- Normally closed thermostats (must be connected to control circuit)
- Meets temperature code T3B
- Shaft slinger
- Nameplated 60/50 Hz, 190/380 Volts, at next lower HP, as noted
- See MOD CENTRAL for:
  - C-Face Kit Modifications
  - F2 mounting
- Ball Bearings (except as noted)
- UL Listed File No. E12044
- CSA Certified File No. LR47504
- Three year warranty



EXPLOSION PROOF



## Rigid Base

HP	RPM	VOLTS	FRAME	GROUP C	CAT. NO.	MODEL NO.	STOCK	CT SPEED RANGE	LIST PRICE	MULT. SYMB.	NOM. EFF.	F.L. AMPS	WEIGHT	"C" DIM.	FOOT NOTES
3/4	1200	208-230/460	143T	N	H350	143TTGN7076	√	10:1	\$721	E7	74.0	3.1-3.2/1.6	55	12.48	25,68,80,91
1	1800	208-230/460	143T	N	<b>U001A</b>	143TTGN6526	√	10:1	\$804	E7	85.5	3.0-3.0/1.5	68	13.48	25,68,80,91
	1800	575	143T	N	<b>U020A</b>	143TTGN6530	√	10:1	\$804	E7	85.5	1.3	68	14.73	25,80
	1800	208-230/460	143T	Y	<b>U986A</b>	143TTGN6532		10:1	\$969	E7	85.5	3.0-3.0/1.5	68	13.48	25,80,91
	1200	208-230/460	145T	N	<b>U039A</b>	145TTGN6576	√	10:1	\$969	E7	82.5	4.0-3.6/1.8	76	14.73	25,68,80,91
1 1/2	3600	208-230/460	143T	N	<b>U058A</b>	143TTGN6501	√	10:1	\$861	E7	84.0	4.4-4.0/2.0	70	13.48	25,68,80,91
	1800	208-230/460	143T	N	<b>U002A</b>	145TTGN6526	√	10:1	\$858	E7	86.5	4.7-4.6/2.3	83	14.73	25,68,80,91
	1800	575	145T	N	<b>U021A</b>	145TTGN6537	√	10:1	\$858	E7	86.5	1.8	85	14.73	25,80
	1800	208-230/460	145T	Y	<b>U987A</b>	145TTGN16532		10:1	\$1,031	E7	86.5	4.7-4.6/2.3	81	14.73	25,80,91
2	1200	208-230/460	182T	N	<b>U040A</b>	182TTGN6576	√	10:1	\$1,010	E7	87.5	4.8-4.4/2.2	147	15.87	25,68,91
	3600	208-230/460	145T	N	<b>U059A</b>	145TTGN6501	√	10:1	\$1,010	E7	85.5	5.6-5.2/2.6	70	13.48	25,68,80,91
	1800	208-230/460	145T	N	<b>U003A</b>	145TTGN6527	√	10:1	\$908	E7	86.5	6.2-6.0/3.0	86	14.73	25,68,80,91
	1800	575	145T	N	<b>U022A</b>	145TTGN6540	√	10:1	\$908	E7	86.5	2.4	86	14.73	25,80
	1800	208-230/460	145T	Y	<b>U988A</b>	145TTGN6550		10:1	\$1,093	E7	86.5	6.2-6.0/3.0	83	14.73	25,80,91
3	1200	208-230/460	184T	N	<b>U041A</b>	184TTGN6576	√	10:1	\$1,143	E7	88.5	6.4-6.0/3.0	154	17.87	25,68,91
	3600	208-230/460	182T	N	<b>U060A</b>	182TTGN6501	√	10:1	\$1,045	E7	87.5	8.4-7.6/3.8	141	15.87	25,68,91
	1800	208-230/460	182T	N	<b>U004A</b>	182TTGN6526	√	10:1	\$1,035	E7	89.5	8.4-8.0/4.0	143	15.87	25,68,91
	1800	575	182T	N	<b>U023A</b>	182TTGN6530	√	10:1	\$1,035	E7	89.5	3.2	141	15.87	25
5	1800	208-230/460	182T	Y	<b>U989A</b>	182TTGN6541		10:1	\$1,245	E7	89.5	8.4-8.0/4.0	161	15.87	25,68,91
	1200	208-230/460	213T	N	<b>U042A</b>	213TTGN6576	√	10:1	\$1,464	E7	89.5	8.8/4.4	244	19.63	25,68
	3600	208-230/460	184T	N	<b>U061A</b>	184TTGN6501	√	10:1	\$1,270	E7	88.5	13.0-12.0/6.0	161	17.87	25,68,91
	1800	208-230/460	184T	N	<b>U005A</b>	184TTGN6526	√	10:1	\$1,135	E7	89.5	13.8-12.4/6.2	155	17.87	25,68,91
1800	575	184T	N	<b>U024A</b>	184TTGN6530	√	10:1	\$1,135	E7	89.5	5.0	156	17.87	25	
	1800	208-230/460	184T	Y	<b>U990A</b>	184TTGN6544		10:1	\$1,366	E7	89.5	13.8-12.4/6.2	150	17.87	25,68,91
	1200	230/460	215T	N	<b>U043A</b>	215TTGN6576	√	10:1	\$1,876	E7	89.5	13.8/6.9	206	22.63	25,68

Catalog numbers (Cat No.) highlighted in bold blue have efficiency levels that meet EISA requirements

Blue shaded areas are Cast Iron Frames

Continued on next page.

# Hazardous Duty™ Division 1 Explosion Proof, NEMA Premium® XRI®, Class I and II, Groups C, D, F & G

## Blue Chip® Severe Duty, Three Phase

### Rigid Base

HP	RPM	VOLTS	FRAME	GROUP C	CAT. NO.	MODEL NO.	STOCK	CT SPEED RANGE	LIST PRICE	MULT. SYMB.	NOM. EFF.	F.L. AMPS	WEIGHT	"C" DIM.	FOOT NOTES	
7 1/2	3600	208-230/460	213T	N	<b>U062A</b>	213TTGN6501	✓	10:1	\$1,619	E7	89.5	20.0-19.0/9.5	256	19.63	25,68,91	
	1800	208-230/460	213T	N	<b>U006A</b>	213TTGN6526	✓	10:1	\$1,536	E7	91.7	20.8-19.2/9.6	248	19.63	25,68,91	
	1800	575	213T	N	<b>U025A</b>	213TTGN16537	✓	10:1	\$1,536	E7	91.7	7.7	243	19.63	25	
	1800	208-230/460	213T	Y	<b>U991A</b>	213TTGN6540	✓	10:1	\$1,849	E7	91.7	20.8-19.2/9.6	251	19.63	25,68,91	
	1800	208-230/460	213T	Y	<b>U991A-P</b>	213TTGN16548	✓	10:1	\$2,071	E7	91.7	20.8-19.2/9.6	251	22.63	25,68,91,P	
	1200	230/460	254T	Y	<b>E500</b>	254TTGN6576	✓	10:1	\$2,246	E7	91.0	19.8/9.9	345	23.52	68	
	10	3600	230/460	215T	Y	<b>U063A</b>	215TTGN6501	✓	10:1	\$1,838	E7	90.2	23.6/11.8	265	22.63	25,68
		1800	208-230/460	215T	N	<b>U007A</b>	215TTGN6526	✓	10:1	\$1,791	E7	91.7	27.0-25.0/12.5	263	22.63	25,68,91
		1800	575	215T	N	<b>U026A</b>	215TTGN16532	✓	10:1	\$1,791	E7	91.7	10.0	248	22.63	25
		1800	208-230/460	215T	Y	<b>U992A</b>	215TTGN6539	✓	10:1	\$2,156	E7	91.7	25.0/12.5	253	22.63	25,68
		1800	230/460	215T	Y	<b>U992A-P</b>	215TTGN16539	✓	10:1	\$2,415	E7	91.7	25.0/12.5	253	22.63	25,68,P
		1200	230/460	256T	Y	<b>E501</b>	256TTGN6576	✓	10:1	\$2,709	E7	91.0	26.2/13.1	360	25.27	68
15	3600	230/460	254T	Y	<b>E502</b>	254TTGN6507	✓	10:1	\$2,196	E7	91.7	35.0/17.5	253	23.52	68	
	1800	230/460	254T	Y	<b>E503</b>	254TTGN6531	✓	10:1	\$2,183	E7	92.4	37.5/18.8	385	23.52	68	
	1800	230/460	254T	Y	<b>E503-P</b>	254TTGN16549	✓	10:1	\$2,445	E7	92.4	37.5/18.8	385	23.52	68,P	
	1800	575	254T	Y	<b>U027A</b>	254TTGN16541	✓	10:1	\$2,183	E7	92.4	15.1	402	23.52		
	1200	230/460	284T	Y	<b>E504</b>	284TTGN6576	✓	10:1	\$3,763	E7	91.7	41.0/20.4	536	26.34	68	
	20	3600	208-230/460	256T	Y	<b>E505</b>	256TTGN16509	✓	10:1	\$3,223	E7	92.4	51-47/23.4	275	25.27	68
1800		230/460	256T	Y	<b>E506</b>	256TTGN6531	✓	10:1	\$2,584	E7	93.0	48.0/24.1	409	25.27	68	
1800		230/460	256T	Y	<b>E506-P</b>	256TTGN16552	✓	10:1	\$2,894	E7	93.0	48.0/24.1	409	25.27	68,P	
1800		575	256T	Y	<b>U028A</b>	256TTGN16540	✓	10:1	\$2,584	E7	93.0	19.3	417	25.27		
1200		230/460	286T	Y	<b>E507</b>	286TTGN16577	✓	10:1	\$4,388	E7	91.7	53.6/26.8	593	27.69		
25	3600	230/460	284TS	Y	<b>E546</b>	284TSTGN6503	✓	10:1	\$3,572	E7	93.6	56.0/28.1	412	24.97	68	
	1800	230/460	284T	Y	<b>E547</b>	284TTGN6533	✓	10:1	\$3,287	E7	93.6	62.0/31.0	536	26.34	68	
	1800	230/460	284T	Y	<b>E547-P</b>	284TTGN16550	✓	10:1	\$3,681	E7	93.6	62.0/31.0	536	26.34	68,P	
	1800	575	284T	Y	<b>U029A</b>	284TTGN16539	✓	10:1	\$3,287	E7	93.6	24.8	358	26.34		
	1800	230/460	284TS	Y	<b>U076A</b>	284TSTGN16531		10:1	\$3,287	E7	93.6	62.0/31.0	484	24.97	68	
	1200	230/460	324T	Y	<b>U048A</b>	324TTGS16577	✓	10:1	\$6,458	E7	93.0	65.0/32.5	681	28.87	68	
30	3600	230/460	286TS	Y	<b>E563</b>	286TSTGN6501	✓	10:1	\$3,849	E7	93.6	67.5/34.0	487	26.47	68	
	1800	230/460	286T	Y	<b>E564</b>	286TTGN6537	✓	10:1	\$3,811	E7	94.1	80.0-73.0/36.5	588	27.84	68	
	1800	230/460	286T	Y	<b>E564-P</b>	286TTGN16546	✓	10:1	\$4,268	E7	94.1	73.0/36.5	588	27.84	68,P	
	1800	575	286T	Y	<b>U030A</b>	286TTGN16533		10:1	\$3,811	E7	93.6	29.2	546	27.84		
	1800	208-230/460	286TS	Y	<b>U077A</b>	286TSTGN16531		10:1	\$3,811	E7	93.6	80.0-73.0/36.5	462	26.47	68	
	1200	230/460	326T	Y	<b>E565</b>	326TTGS6578	✓	10:1	\$7,021	E7	93.0	77.0/38.5	900	30.37	68	
40	3600	230/460	324TS	Y	<b>E566</b>	324TSTGS6501	✓	10:1	\$5,181	E7	93.6	94.0/47.0	734	28.87	68	
	1800	230/460	324T	Y	<b>E567</b>	324TTGS6529	✓	10:1	\$5,072	E7	94.1	95.0/47.5	749	30.37	68	
	1800	230/460	324T	Y	<b>E567-P</b>	324TTGS16541	✓	10:1	\$5,681	E7	94.1	95.0/47.5	749	30.37	68,P	
	1800	575	324T	Y	<b>U031A</b>	324TTGS16535		10:1	\$5,072	E7	94.1	38.0	572	30.37		
	1800	230/460	324TS	Y	<b>U078A</b>	324TSTGS16531		10:1	\$5,072	E7	94.1	95.0/47.5	770	28.87	68	
	1200	230/460	364T	Y	<b>E568A</b>	364TTGS16577	✓	10:1	\$8,443	E7	93.6	100/50.0	1151	31.50	68	
50	3600	230/460	326TS	Y	<b>E569</b>	326TSTGS6501	✓	10:1@	\$6,570	E7	93.6	118/59.0	831	30.37	68	
	1800	230/460	326T	Y	<b>E570</b>	326TTGS6532	✓	10:1@	\$6,177	E7	94.5	123/61.5	791	30.37	68	
	1800	230/460	326T	Y	<b>E570-P</b>	326TTGS16546	✓	10:1@	\$6,918	E7	94.5	123/61.5	791	30.37	68,P	
	1800	575	326T	Y	<b>U032A</b>	326TTGS16539		10:1@	\$6,177	E7	94.5	49.0	572	30.37	68	
	1800	208-230/460	326TS	Y	<b>U079A</b>	326TSTGS16532		10:1@	\$6,177	E7	94.5	120/60.0	688	28.87	68	
	1200	230/460	365T	Y	<b>E571</b>	365TTGS16577	✓	10:1@	\$9,135	E7	94.5	123/61.5	1099	32.50	87	
60	3600	230/460	364TS	Y	<b>E572</b>	364TSTGS6506	✓	10:1@	\$9,544	E7	94.5	134/67.0	1033	29.38	87	
	1800	230/460	364T	Y	<b>E573A</b>	364TTGS16536	✓	10:1@	\$9,484	E7	95.0	138/69.0	1178	31.50	87	
	1800	575	364T	Y	<b>U033A</b>	364TTGS16537		10:1@	\$9,484	E7	95.0	55.0	1161	31.50		
	1800	208-230/460	364TS	Y	<b>U080A</b>	364TSTGS16531		10:1@	\$9,484	E7	95.0	138/69.0	1145	29.38	68	
1200	230/460	404T	Y	<b>E574</b>	404TTGS6588	✓	10:1@	\$11,407	E7	94.5	144/72.0	1295	35.62			

Catalog numbers (Cat No.) highlighted in bold blue have efficiency levels that meet EISA requirements

Blue shaded areas are Cast Iron Frames

@ Requires larger fan

Continued on next page.

# Hazardous Duty™ Division 1 Explosion Proof, NEMA Premium® XRI®, Class I and II, Groups C, D, F & G

## Blue Chip® Severe Duty, Three Phase

### Rigid Base

HP	RPM	VOLTS	FRAME	GROUP C	CAT. NO.	MODEL NO.	STOCK	CT SPEED RANGE	LIST PRICE	MULT. SYMB.	NOM. EFF.	F.L. AMPS	WEIGHT	"C" DIM.	FOOT NOTES
75	3600	230/460	365TS	Y	<b>E575</b>	365TSTGS16503	√	10:1@	\$11,060	E7	94.1	169/84.5	1097	30.38	87
	1800	230/460	365T	Y	<b>E576A</b>	365TTGS16540	√	2:1	\$11,007	E7	95.4	174/87.0	1124	32.50	A,68
	1800	575	365T	Y	<b>U034A</b>	365TTGS16542		2:1	\$11,007	E7	95.4	69.0	1094	32.50	A
	1800	208-230/460	365TS	Y	<b>U081A</b>	365TSTGS16532		2:1	\$11,007	E7	95.4	174/87	1087	30.38	A,68
	1200	230/460	405T	Y	<b>E577</b>	405TTGS6589	√	10:1@	\$13,283	E7	94.5	180/90.0	1388	37.12	87
100	3600	230/460	405TS	Y	<b>E578</b>	405TSTGS6503		10:1	\$14,962	E7	94.5	216/108	1349	34.12	87
	1800	230/460	405T	Y	<b>E59A</b>	405TTGS6548	√	2:1	\$13,577	E7	95.4	226/113	1479	37.12	68
	1800	575	405T	Y	<b>U035A</b>	405TTGS16539		2:1	\$13,577	E7	95.4	90.5	1365	37.12	87
	1800	208-230/460	405TS	Y	<b>U082A</b>	405TSTGS16531		2:1	\$13,577	E7	95.4	226/113	1333	34.12	87
	1200	230/460	444T	Y	<b>E580A</b>	444TTGN16580	√	10:1@	\$18,980	E7	95.0	248/124	1813	41.35	68,87
125	3600	460	444TS	Y	<b>U073A</b>	444TSTGN16502		2:1	\$24,057	E7	94.5	139	1824	36.70	68
	1800	460	444T	Y	<b>E582A</b>	444TTGN16532	√	10:1@	\$19,926	E7	95.4	143	1845	41.35	68
	1800	575	444T	Y	<b>U036A</b>	444TTGN16533		10:1@	\$19,926	E7	95.4	114	1808	41.35	
	1800	460	444TS	Y	<b>U083A</b>	444TSTGN16531		10:1@	\$19,926	E7	95.4	143	1835	37.60	
	1200	460	445T	Y	<b>E583</b>	445TTGN6597		---	\$21,820	E7	95.0	155	2200	43.25	
150	3600	460	445TS	Y	<b>E584</b>	445TSTGN16505		---	\$28,159	E7	95.0	168	1941	39.60	
	1800	460	445T	Y	<b>E585</b>	445TTGN6542	√	2:1	\$20,729	E7	95.4	172	2173	43.35	68
	1800	575	445T	Y	<b>U037A</b>	445TTGN16544		2:1	\$20,729	E7	95.4	138	2236	43.35	
	1800	460	445TS	Y	<b>U084A</b>	445TSTGN16531		2:1	\$20,729	E7	95.4	172	2163	39.60	68
	1200	460	445T	Y	<b>U090A</b>	445TTGN16588	√	---	\$23,454	E7	95.8	181	2384	43.35	RB,68
200	3600	460	445TS	Y	<b>U075A</b>	445TSTGN16506		---	\$34,359	E7	95.4	226	2395	39.6	
	1800	460	445T	Y	<b>E588</b>	445TTGN6538		10:1@	\$23,500	E7	96.2	224	2500	43.19	68
	1800	575	445T	Y	<b>U038A</b>	445TTGN16543		10:1@	\$23,500	E7	96.2	179	2384	43.35	RB
	1200	460	449T	Y	<b>U091A</b>	449TTGS16585		10:1	\$33,349	E7	95.8	240	2878	51.85	RB,68
250	3600	460	449TS	Y	<b>E595</b>	449TSTGS14003		---	\$34,888	E7	96.5	275	2867	47.94	68,87
	1800	460	449T	Y	<b>E591</b>	449TTGS16537		10:1	\$28,830	E7	96.5	285	3012	51.85	RB
	1800	460	449T	Y	<b>H502</b>	449TTGS7068		2:1	\$26,974	E7	95.0	290	2779	51.85	RB,17,68,87
300	1800	460	449T	Y	<b>H503</b>	449TTGS7037		2:1	\$30,039	E7	96.5	338	3032	51.85	RB,17,68,87
350	1800	460	449T	Y	<b>H504</b>	449TTGS7036	√	---	\$33,688	E7	96.2	400	3280	51.85	RB,17

EXPLOSION PROOF

Catalog numbers (Cat No.) highlighted in bold blue have efficiency levels that meet EISA requirements

Blue shaded areas are Cast Iron Frames

@ Requires larger fan

#### "R164 Rework" Table:

**R-164 Rework for 10:1 Constant Torque:  
Fan Change\* & Re-Nameplate**

FRAME	LIST PRICE
143-215	\$230
254-286	\$263
324-326	\$296
364-365	\$296
404-449	\$329

#### Multiplier Symbol S4

\* Fan change to allow 10:1 constant torque may reduce motor full load efficiency below EPAAct levels.

Operation of motor on non-sinusoidal wave form (VFD) exempts motor from EPAAct mandated efficiency levels.

# Medium Voltage Motors

Marathon Motors's Medium Voltage motors are available through 6000 horsepower, and through 13.2 kV (13,200 volts). Enclosures include Dripproof (ODP), WP1, WP11, Totally Enclosed Fan Cooled (TEFC), Totally Enclosed Air-to-Air Cooled (TEAAC) and Totally Enclosed Water-to-Air Cooled (TEWAC). Contact Marathon Motors for a quotation on any ratings or configurations not listed below.



## Medium Voltage ODP/TEFC

Range:  
TEFC: 125-2500HP, 90-1850kW  
ODP: 125-5000HP, 90-3700kW  
Voltage: 2,300-13,800V  
Pole: 2-, 4-, 6-, pole  
Hertz: 50 or 60 Hertz  
Frame: 449-5013 NEMA, 355-560 IEC  
Protection: IP22 through IP56  
Insulation: Class H&F VPI  
Fabricated Steel or Cast Iron Construction  
Performance: NEMA / IEC  
Bearings: Anti-Friction  
Service Factor: 1.15  
Inverter: Yes  
Warranty: 12/18 mo. & 12/24 mo. UL / CSA

## ANEMA ODP/WP1

Range: 250-6000HP, 185-4600kW  
Voltage: 2300-13800V  
Pole: 2-, 4-, 6-, pole  
Hertz: 50 or 60 Hertz  
Frame: 5000-5800 NEMA, 355-900 IEC  
Protection: IP23  
Insulation: Class F VPI  
Construction: Fabricated  
Performance: NEMA / IEC  
Bearings: Anti-Friction, sleeve available  
Service Factor: 1.15  
Inverter: Yes  
Warranty: 12/24 mo. UL / CSA

## ANEMA WP11

Range: 250-6000HP, 185-4600kW  
Voltage: 2300-13800V  
Pole: 2-, 4-, 6- pole  
Hertz: 50 or 60 Hertz  
Frame: 5000-5800 NEMA, 355-900 IEC  
Protection: IPW23  
Insulation: Class F VPI  
Construction: Fabricated  
Performance: NEMA / IEC  
Bearings: Anti-Friction, sleeve available  
Service Factor: 1.15  
Inverter: Yes  
Warranty: 12/24 mo. UL / CSA

## ANEMA TEAAC/TEWAC

Range: 300-6000HP, 225-4600kW  
Voltage: 2300-13800V  
Pole: 2-, 4-, 6- pole  
Hertz: 50 or 60 Hertz  
Frame: 355-900 IEC  
Protection: IP44  
Insulation: Class F VPI  
Construction: Fabricated  
Performance: IEC  
Bearings: Anti-Friction, sleeve available  
Service Factor: 1.15  
Inverter: Yes  
Warranty: 12/24 mo. UL / CSA

MEDIUM VOLTAGE

## Features:

	Dripproof, 449-510 frame	Totally Enclosed, 449 frame	Totally Enclosed, 5000 frame
NEMA Premium efficiencies as noted (Table 12-13)	X	X	X
Cast iron construction B-10 life on direct-coupled loads	X	X	X
Open Conrad radial ball bearings rated for 100,000 hour B-10 life on direct-coupled loads	X	X	X
Roller bearing for belted loads	OPT	OPT	OPT
Oversized, fabricated steel conduit box	X		
Oversized, cast iron conduit box		X	X
1.15 Service Factor as available (consult factory)	OPT	OPT	OPT
Class H insulation and form wound coils	X	X	X
Epoxy, 100% solids, Vacuum Pressure Impregnation (VPI) resin	X	X	X
Grease fittings with extended grease tubes		X	X
Internal and external epoxy finish		X	X
Front and rear cast iron bearing caps		X	X
Actual test and vibration data included with each order		X	X
CSA Certified for Div. 2/Zone 2, Group A, B, C, D and Group IIA, IIB, IIC		X	X
Temp Code T3 @ 1.0 Service Factor		X	
Temp Code T2C @ 1.0 Service Factor			X
Temp Code T2B @ 1.15 Service Factor		X	X
IEEE-841 features		OPT	OPT
Provisions for jacking bolts in all four feet			X
Rotating shaft seals, Inpro® Smart Rings on each end			X
Provisions for dowel pins in drive end feet			X
Ground provisions on foot and in the conduit box			X
Dedicated 5009 frame for vertical applications			X
Frames drilled with four sets of footholes, 5009, 5010, 5011, 5012			X

# Medium Voltage Motors

Multiplier Symbol S4

HP	RPM	DRIPPROOF				TOTALLY ENCLOSED			
		NEMA PREMIUM	FRAME	CAT. NO.	LIST PRICE	NEMA PREMIUM	FRAME	CAT. NO.	LIST PRICE
100	900	---	---	---	---	N/A	447/9T	Y255	\$44,021
125	1800	---	---	---	---	N/A	L447/9T	Y256	\$36,841
	1200	---	---	---	---	N/A	447/9T	Y257	\$46,638
	900	N/A	449T	Y948	\$31,755	N/A	5011LS	Y913	\$50,854
150	3600	---	---	---	---	N/A	447/9TS	Y903	\$40,169
	1800	---	---	---	---	N/A	L447/9T	Y900	\$38,365
	1200	---	---	---	---	N/A	447/9T	Y904	\$48,291
	900	N/A	508U	Y949	\$36,639	N/A	5011LS	Y914	\$55,271
200	3600	---	---	---	---	N/A	L447/9TS	Y905	\$42,734
	1800	N/A	449T	Y950	\$30,612	N/A	L447/9T	Y901	\$40,799
	1200	N/A	449T	Y958	\$33,408	N/A	L447/9T	Y906	\$48,853
	1200	---	---	---	---	N/A	5011LS	Y920	\$49,763
	900	N/A	508U	Y250	\$42,366	N/A	5011LS	Y915	\$58,343
250	3600	N/A	449TS	Y954	\$36,953	N/A	5011S	Y258	\$53,013
	1800	N/A	449T	Y951	\$32,220	Y	L447/9T	Y902	\$44,352
	1200	N/A	508U	Y955	\$35,172	Y	L447/9T	Y907	\$54,020
	1200	---	---	---	---	Y	5011LX	Y921	\$55,424
	900	N/A	510U	Y251	\$46,048	N/A	5011LS	Y916	\$60,035
300	3600	N/A	449TS	Y956	\$38,415	N/A	5011S	Y259	\$54,624
	1800	---	---	---	---	Y	L447/9T	Y908	\$49,927
	1800	N/A	508U	Y952	\$35,163	Y	5011LS	Y922	\$52,040
	1200	N/A	508U	Y942	\$38,140	Y	5011LS	Y923	\$58,781
	900	N/A	510U	Y252	\$59,657	N/A	5013LS	Y917	\$69,192
350	3600	N/A	449TS	Y957	\$39,892	N/A	5011S	Y260	\$55,430
	1800	N/A	508U	Y953	\$36,435	Y	5011LS	Y924	\$52,770
	1200	N/A	508U	Y943	\$41,168	Y	5011LS	Y925	\$61,156
	1200	---	---	---	---	Y	5011LX	Y935	\$64,542
	900	---	---	---	---	N/A	5013LS	Y918	\$77,531
400	3600	N/A	508U	Y910	\$43,857	N/A	5011S	Y261	\$61,100
	1800	Y	508U	Y940	\$37,684	Y	5011LS	Y926	\$56,443
	1800	---	---	---	---	Y	5011LX	Y936	\$59,800
	1200	Y	510U	Y944	\$51,191	Y	5011LS	Y927	\$67,101
	900	---	---	---	---	N/A	5013LS	Y912	\$93,376
450	3600	---	---	---	---	N/A	5011S	Y263	\$63,146
	1800	Y	508US	Y911	\$44,726	Y	5011LS	Y928	\$60,119
	1800	Y	510U	Y941	\$40,660	Y	5011LX	Y937	\$63,474
	1200	Y	510U	Y945	\$60,053	Y	5013LS	Y929	\$72,852
	900	---	---	---	---	N/A	5013LS	Y262	\$96,676
500	1800	Y	510U	Y946	\$49,470	Y	5011LS	Y930	\$66,129
	1800	---	---	---	---	Y	5011LX	Y938	\$69,486
	1200	Y	510U	Y947	\$73,192	Y	5013LS	Y931	\$77,748
600	1800	N/A	510U	Y253	\$60,366	N/A	5011LS	Y932	\$86,835
	1800	---	---	---	---	N/A	5011LX	Y939	\$90,191
700	1800	N/A	510U	Y254	\$63,514	N/A	5013LS	Y933	\$92,869
800	1800	---	---	---	---	N/A	5013LS	Y934	\$99,622

MEDIUM VOLTAGE

# Inverter (Vector) Duty: microMAX™

## 1000:1 Constant Torque (TENV), 20:1 Constant Torque (TEFC)

### Totally Enclosed, Three Phase

#### Applications:

Designed for direct replacement of PMDC or any other variable speed application where up to a 1000:1 constant torque speed range is required. Typical uses include: machine tools, conveyors, packaging machines, batching machines, and printing equipment.

#### Features:

- Designed to replace PMDC motors (when used with a VFD)
- Constant horsepower to twice base speed (RPM)
- Class H insulation with CR200 magnet wire
- Removable base for C-Face footless mounting, as noted
- Continuous duty at 40°C ambient
- "Quick Connect" terminal board, as noted
- Top mounted conduit box as found on PMDC motors
- Eliminates brush and commutator maintenance
- UL Recognized, CSA Certified, and CE Mark
- Three year warranty



#### C-Face Footless

HP	RPM	VOLTS	FRAME	CAT. NO.	MODEL NO.	STOCK	LIST PRICE	MULT. SYMB.	F.L. AMPS	WEIGHT	"C" DIM.	FOOT NOTES
1/8	1800	230	56C	Y606	056H17T2022	✓	\$235	E3	0.7	15	9.16	N,Q
1/4	1800	230	56C	Y501	056H17T2012	✓	\$254	E3	1.0	16	9.91	N,Q
1/3	1800	230	56C	Y503	056H17T2014	✓	\$274	E3	1.2	17	9.91	N,Q
1/2	1800	230	56C	Y505	056H17T2016		\$322	E3	1.8	24	9.91	N,Q
	1800	230/460	56C	Y374	056H17T2018	✓	\$322	E3	1.8/0.9	24	9.91	N
	1800	575	56C	Y375	056H17T2020		\$322	E3	0.7	24	9.91	N,Q
3/4	1800	230	56C	Y507	056H17F2012		\$398	E3	2.8	21	11.19	
	1800	230/460	56C	Y376	056H17F2018	✓	\$398	E3	2.8/1.4	21	11.19	
	1800	575	56C	Y377	056H17F2016		\$398	E3	1.1	21	11.19	
1	1800	230	56C	Y521	056H17F2014		\$448	E3	3.2	27	12.44	
	1800	230/460	56C	Y378	056H17F2022	✓	\$448	E3	3.2/1.6	27	12.44	
	1800	575	56C	Y379	056H17F2020		\$448	E3	1.3	27	12.44	

#### C-Face Footed (Rigid Base)

HP	RPM	VOLTS	FRAME	CAT. NO.	MODEL NO.	STOCK	LIST PRICE	MULT. SYMB.	F.L. AMPS	WEIGHT	"C" DIM.	FOOT NOTES
1/8	1800	230	56C	Y605	056H17T2021		\$235	E3	0.7	18	9.16	d,N,Q
1/4	1800	230	56C	Y500	056H17T2011	✓	\$254	E3	1.0	17	9.91	N,Q
1/3	1800	230	56C	Y502	056H17T2013	✓	\$274	E3	1.2	17	9.91	N,Q
1/2	1800	230	56C	Y504	056H17T2015	✓	\$322	E3	1.8	24	9.91	N,Q
	1800	230/460	56C	Y360	056H17T2017	✓	\$322	E3	1.8/0.9	24	9.91	N
	1800	575	56C	Y361	056H17T2019		\$322	E3	0.7	12	9.91	N,Q
3/4	1800	230	56C	Y506	056H17F2011	✓	\$398	E3	2.8	22	11.19	
	1800	230/460	56C	Y362	056H17F2017	✓	\$398	E3	2.8/1.4	21	11.19	
	1800	575	56C	Y363	056H17F2015		\$398	E3	1.1	22	11.19	
1	1800	230	56C	Y508	056H17F2013		\$448	E3	3.2	28	12.44	
	1800	230/460	56C	Y364	056H17F2021	✓	\$448	E3	3.2/1.6	27	12.44	
	1800	575	56C	Y365	056H17F2019	✓	\$448	E3	1.3	22	12.44	
1 1/2	1800	230	145TC	Y522	145THTR5328	✓	\$557	E3	4.8	48	13.48	N,6
	1800	230/460	145TC	Y366	145THTR5329	✓	\$557	E3	4.8/2.4	49	13.48	N,6
	1800	575	145TC	Y367	145THTR5330		\$557	E3	1.9	50	13.48	N,6
2	1800	230	145TC	Y523	145THFR5326		\$739	E3	5.8	53	14.87	6
	1800	230/460	145TC	Y368	145THFR5329	✓	\$739	E3	5.8/2.9	50	14.87	6
	1800	575	145TC	Y369	145THFR5330	✓	\$739	E3	2.3	49	14.87	6

Continued on next page.

# Inverter (Vector) Duty: microMAX™

## 1000:1 Constant Torque (TENV), 20:1 Constant Torque (TEFC)

### Totally Enclosed, Three Phase

#### C-Face Footed (Rigid Base)

HP	RPM	VOLTS	FRAME	CAT. NO.	MODEL NO.	STOCK	LIST PRICE	MULT. SYMB.	F.L. AMPS	WEIGHT	"C" DIM.	FOOT NOTES
3	1800	230/460	182/145TC	Y370	182THFR5329	✓	\$871	E3	8.4/4.2	52	14.87	86,88
	1800	230/460	182TC	Y1999	182THFW7729	✓	\$909	E3	8.4/4.2	76	13.97	6,13
	1800	575	182/145TC	Y371	182THFR5330		\$871	E3	3.4	52	14.87	86,88
5	1800	575	182TC	Y270A	182THFW7730		\$909	E3	2.9	86	14.97	6,13
	1800	230/460	184TC	Y1372	184THFW7726	✓	\$1,034	E3	13.0/6.5	92	13.97	6,13
	1800	575	184TC	Y373A	184THFW7736	✓	\$1,034	E3	5.2	95	13.97	6,13
7 1/2	1800	230/460	213TC	Y994	213THFW7726	✓	\$1,322	E3	21.4/10.7	98	20.97	6
	1800	575	213TC	Y995	213THFW7736		\$1,322	E3	8.5	98	20.97	6
10	1800	230/460	215TC	Y996	215THFW7726	✓	\$1,691	E3	27.6/13.8	125	22.22	6
	1800	575	215TC	Y997	215THFW7736		\$1,691	E3	11.1	125	22.22	

# Inverter (Vector) Duty: Max + (with Encoder)

## 1000:1 Constant Torque, Totally Enclosed, Three Phase

#### Applications:

The **MAX+** incorporates low rotor inertia for fast starts, stops, and reversals. Coupled with an encoder make this useful in applications traditionally served only by servo systems. The **MAX+** is also suitable for all applications where up to a 1000:1 Constant Torque speed range or positioning is required.

#### Features:

- Integrated Dynapar HS20 1024 ppr encoder
- Class F insulation with CR200 corona resistant magnet wire
- Constant Torque operation from 0 to base speed on Vector Drive
- Constant Horsepower operation up to twice base RPM
- Continuous duty at 40°C ambient
- Optimized for operation with IGBT inverter
- Removable base for C-Face footless mounting, as noted
- Ball bearings
- Field reversible to F2 (except as noted)
- UL Recognized, CSA Certified, and CE Mark
- Three year warranty



Opposite drive end shown



#### C-Face Footed (Rigid Base)

HP	RPM	VOLTS	FRAME	ENCODER PPR	CAT. NO.	MODEL NO.	STOCK	LIST PRICE	MULT. SYMB.	F.L. AMPS	WEIGHT	"C" DIM.	FOOT NOTES
1/2	1800	230/460	56C	1024	Y280	056H17T15526	✓	\$992	E3	1.6/8	29	13.48	S,6,13
3/4	1800	230/460	56C	1024	Y281	056H17T15528	✓	\$1,038	E3	2.4/1.2	35	13.48	S,6,13
1	1800	230/460	56C	1024	Y282	056H17T15527	✓	\$1,099	E3	3/1.5	41	14.98	S,6,13
	1800	230/460	143TC	1024	Y283	143THTR15535	✓	\$1,183	E3	3/1.5	42	15.04	d
1 1/2	1800	230/460	145TC	1024	Y284	145THTR15540	✓	\$1,308	E3	4/2	50	16.04	S,6,13
2	1800	230/460	145TC	1024	Y285	145THTN17034	✓	\$1,755	E3	6/3	75	14.68	
3	1800	230/460	182TC	1024	Y286	182HTL17041	✓	\$1,972	E3	8.4/4.2	95	17.39	AL
5	1800	230/460	184TC	1024	Y287	184HTL17038	✓	\$2,147	E3	14/7	112	18.94	AL

Blue shaded areas are Cast Iron Frames

# Inverter (Vector) Duty: Black Max® 1000:1 Constant Torque, TENV, Three Phase

## Applications:

Designed for inverter or vector applications where up to a 1000:1 Constant Torque speed range is required. Typical uses include: material handling, machine tools, conveyors, crane and hoist, metal processing, test stands, pumps compressors, textile processing, and other industrial machinery installed in dusty or dirty environments.

## Features:

- MAX GUARD® Class F insulation system
- Constant Torque operation from 0 to base speed on Vector Drive
- Constant Horsepower operation up to twice base RPM
- Continuous duty at 40°C ambient
- Optimized for operation with IGBT inverter (NEMA Design A)
- Normally closed thermostats (one per phase, Class F)
- Removable rigid base, as noted
- Ball Bearings
- Field reversible to F2 (except as noted)
- Encoder and brake provisions included on opposite drive end (maximum 10 lb-ft brake, see Modifications and/or Accessory Kits sections)
- UL Recognized, CSA Certified, and CE Mark
- Three year warranty



## C-Face Footed (Rigid Base)

HP	RPM	VOLTS	FRAME	OVER LOAD	CAT. NO.	MODEL NO.	STOCK	LIST PRICE	MULT. SYMB.	F.L. AMPS	WEIGHT	"C" DIM.	FOOT NOTES
1/4	1800	230/460	56C	TSTAT	Y592	056H17T2001	✓	\$373	E3	1.2/0.6	19	11.88	S,13
1/2	1800	230/460	56C	TSTAT	Y534	056H17T5301	✓	\$467	E3	1.6/0.8	35	13.48	S,6,13
	1800	575	56C	TSTAT	Y555	056H17T5311	✓	\$467	E3	0.6	35	13.48	S,6,13
1	1800	230/460	56C	TSTAT	Y535	056H17T5302	✓	\$557	E3	3.0/1.5	39	14.98	S,6,13
	1800	575	56C	TSTAT	Y556	056H17T5312	✓	\$557	E3	1.2	39	14.98	S,6,13
	1800	230/460	143TC	TSTAT	Y536	143THTR5326	✓	\$572	E3	3.0/1.5	48	15.04	S,6,13
	1200	230/460	145TC	TSTAT	Y537	145THTR5376	✓	\$663	E3	3.8/1.9	49	16.04	S,6,13
1 1/2	1800	230/460	145TC	TSTAT	Y538	145THTR5326	✓	\$695	E3	4.8/2.4	50	16.04	S,6,13
2	1800	230/460	145TC	TSTAT	Y612	145THTR16032		\$895	E3	6.0/3.0	65	16.04	S,6,13
	1800	230/460	145TC	TSTAT	Y551	145HTN6046	✓	\$960	E3	6.0/3.0	73	14.68	
	1800	575	145TC	TSTAT	Y611	145THTR16031		\$895	E3	2.4	65	16.04	S,6,13
	1800	575	145TC	TSTAT	Y557	145HTN6060	✓	\$960	E3	2.4	73	14.68	
3	1200	230/460	184TC	TSTAT	Y540	184THTL7776	✓	\$1,373	E3	6.6/3.3	88	16.94	AL
	1800	230/460	182TC	TSTAT	Y541	182THTL7726	✓	\$1,190	E3	8.4/4.2	95	17.39	AL
	1800	575	182TC	TSTAT	Y558	182THTL7736	✓	\$1,190	E3	3.4	95	17.39	AL
5	1200	230/460	213TC	TSTAT	Y542	213THTL7776	✓	\$1,691	E3	9.4/4.7	105	19.94	AL
	1800	230/460	184TC	TSTAT	Y543	184THTL7726	✓	\$1,421	E3	14.0/7.0	110	18.94	AL
	1800	575	184TC	TSTAT	Y559	184THTL7736	✓	\$1,421	E3	5.6	110	18.94	AL
7 1/2	1200	230/460	215TC	TSTAT	Y544	215THTL7776	✓	\$2,057	E3	15.4/7.7	146	20.54	AL
	1800	230/460	213TC	TSTAT	Y545	213THTL7726	✓	\$1,865	E3	21.0/10.5	146	20.54	AL
	1800	575	213TC	TSTAT	Y560	213THTL7736	✓	\$1,865	E3	8.4	146	20.54	AL
10	1200	230/460	254TC	TSTAT	Y546	254THTL5776	✓	\$2,767	E3	22.0/11.0	223	25.37	AL,I
	1800	230/460	215TC	TSTAT	Y547	215THTL7726	✓	\$2,231	E3	27.0/13.5	219	23.04	AL
	1800	575	215TC	TSTAT	Y561	215THTL7736	✓	\$2,231	E3	10.8	219	23.04	AL
15	1200	230/460	256TC	TSTAT	Y548	256THTL5776	✓	\$3,132	E3	28.0/14.0	229	26.87	AL,I
	1800	230/460	254TC	TSTAT	Y549	254THTL5726	✓	\$2,655	E3	40.0/20.0	260	26.87	I,AL
	1800	575	254TC	TSTAT	Y562	254THTL5736	✓	\$2,655	E3	16.0	260	26.87	I,AL
20	1800	230/460	256TC	TSTAT	Y552	256THTNA7026	✓	\$3,876	E3	52.0/26.0	300	27.13	
	1800	575	256TC	TSTAT	Y563	256THTNA7036	✓	\$3,876	E3	20.8	300	27.13	
25	1800	230/460	284TC	TSTAT	Y553	284THTNA7026	✓	\$4,216	E3	62.0/31.0	379	27.08	I
	1800	575	284TC	TSTAT	Y567	284THTNA7036		\$4,216	E3	24.8	379	27.08	I
30	1800	230/460	286TC	TSTAT	Y393	286THTNA7026	✓	\$4,754	E3	74.0/37.0	575	28.58	I
	1800	575	286TC	TSTAT	Y394	286THTNA7036		\$4,754	E3	29.6	575	28.58	I

Contact Marathon for other base speeds and options not shown in this catalog.

Blue shaded areas are Cast Iron Frames



# Inverter (Vector) Duty: Black Max® Hazardous Duty™ 1000:1 Constant Torque, Explosion Proof, Three Phase Class I and II (gases and dust), Groups C, D, F & G, TENV

## Applications:

For use in material handling, machine tools, conveyors, crane & hoist, and other variable speed applications requiring up to 1000:1 constant torque speed range, to be installed in hazardous environments as defined by the motor's explosion proof class and group rating. Refer to the General Information sections contained in this catalog for information on explosion proof classifications. Consult the National Electrical Code and your local regulations for the proper selection of motors in hazardous locations.

## Features:

- MAX GUARD® Class F insulation system
- Constant torque operation from 0 to base speed on vector drive
- Constant HP operation to twice base RPM
- Continuous duty at 40°C ambient
- Optimized for operation with IGBT inverter (NEMA Design A)
- Normally closed thermostats (one per phase, Class F)
- Ball Bearings
- Top mount (F3) conduit box included, shipped loose
- No Encoder Provisions provided
- Meets temperature code T3B
- UL listed, under file #E12044
- CSA certified, under file numbers LR47504 and LR21839
- Three year warranty



## C-Face Footed (Rigid Base)

HP	RPM	VOLTS	FRAME	OVER LOAD	CAT. NO.	MODEL NO.	STOCK	LIST PRICE	MULT. SYMB.	F.L. AMPS	WEIGHT	"C" DIM.	FOOT NOTES
1/4	1800	230/460	56C	TSTAT	Y600	056H17E5301	√	\$556	E3	1.1/0.55	26	11.97	
1/3	1800	230/460	56C	TSTAT	Y601	056H17E5302	√	\$652	E3	1.2/0.6	26	11.97	
1/2	1800	230/460	56C	TSTAT	Y602	056H17E5303	√	\$703	E3	1.6/0.8	31	12.47	
3/4	1800	230/460	56C	TSTAT	Y603	056H17E5304	√	\$778	E3	2.4/1.2	38	13.47	
1	1800	230/460	56C	TSTAT	Y604	056H17E5305	√	\$852	E3	3.0/1.5	43	13.97	

Contact Marathon for other base speeds and options not shown in this catalog.

# Inverter (Vector) Duty: Blue Max® 2000 2000:1 Constant Torque, Totally Enclosed, Three Phase

## Applications:

Designed for inverter or vector applications where up to a 2000:1 constant torque speed range is required. Typical uses include: material handling, machine tools, conveyors, crane and hoist, metal processing, test stands, pumps, compressors, textile processing, and other industrial machinery installed in dusty or dirty environments where cast iron construction is required.

## Features:

- MAX GUARD® Class H insulation system
- Constant torque operation from 0 to base speed on vector drive, including TEFC (On Volts/Hertz drives, TEFC motors are limited to 20:1 constant torque)
- Constant HP operation to twice base speed (143-256 frame); 1.5 times base (all others)
- Optimized for operation with IGBT inverter
- C-Face foot mount through 100 HP, as noted
- Normally closed thermostats (one per phase, class F)
- Continuous duty at 40°C ambient
- 1.0 Service Factor ("B" rise on TEBC motors)
- Blue Chip quality, cast iron frame and brackets
- Patented "fracket" design (TEBC enclosure)
- Ball Bearings (roller bearing available 360 Frame & larger)
- Field reversible to F2
- Encoder provisions included on opposite drive end (see Modification and/or Accessory Kits sections)
- UL Recognized, CSA Certified, and CE Mark
- Three year warranty



## Rigid Base and C-Face Footed (Rigid Base)

HP	RPM	VOLTS	ENCL	FRAME	CAT. NO.	MODEL NO.	STOCK	LIST PRICE	MULT. SYMB.	F.L. AMPS	WEIGHT	"C" DIM.	FOOT NOTES
1	1800	230/460	TENV	143TC	Y525	143THTN8028	✓	\$1,003	E3	3.0/1.5	61	13.68	B
1 1/2	1800	230/460	TENV	145TC	Y590	145THTN8037	✓	\$1,008	E3	4.6/2.3	65	14.68	
2	1800	230/460	TENV	145TC	Y526	145THTN8029	✓	\$1,086	E3	6.0/3.0	71	14.68	
3	1800	230/460	TENV	182TC	Y527	182THTS8028	✓	\$1,364	E3	8.0/4.0	113	16.68	
5	1800	230/460	TENV	184TC	Y564	184THTS8028	✓	\$1,525	E3	13.4/6.7	147	17.68	
7 1/2	1800	230/460	TEFC	213TC	Y595	213THFS8028	✓	\$1,784	E3	19.4/9.7	192	21.03	
	1800	230/460	TENV	213TC	Y565	213THTS8038	✓	\$2,055	E3	21.0/10.5	85	20.56	
10	1800	230/460	TEFC	215TC	Y596	215THFS8029	✓	\$2,132	E3	25.4/12.7	212	22.53	
	1800	230/460	TENV	215TC	Y566	215THTS8038	✓	\$2,437	E3	26.0/13.0	272	22.74	
15	1800	230/460	TEFC	254TC	Y597	254THFNA8038	✓	\$2,568	E3	37.0/18.5	350	26.34	
	1800	230/460	TENV	254TC	Y509	254THTNA8058	✓	\$2,917	E3	40.4/20.2	334	23.38	
	1200	230/460	TEBC	284TC	Y395	284THFPA8086		\$5,723	E3	40.0/20.0	500	37.48	BP
20	1800	230/460	TEFC	256TC	Y598	256THFNA8038	✓	\$2,841	E3	52.0/26.0	377	28.09	
	1800	230/460	TENV	256TC	Y510	256THTNA8038	✓	\$4,038	E3	52.0/26.0	425	27.13	
	1200	230/460	TEBC	286TC	Y582	286THFPA8086		\$7,399	E3	52.4/26.2	660	38.98	BP
25	1800	230/460	TEFC	284T	Y569	284THFPA8028	✓	\$3,548	E3	63.0/31.5	393	28.58	
	1800	230/460	TEBC	284TC	Y511	284THFPA8038	✓	\$4,959	E3	63.0/31.5	470	37.48	BP
	1200	230/460	TEBC	324TC	Y583	324THFPA8086		\$8,703	E3	67.0/33.5	633	40.41	B,BP
30	1800	230/460	TEFC	286T	Y570	286THFNA8028	✓	\$4,056	E3	77.0/38.5	371	29.91	
	1800	230/460	TEBC	286TC	Y512	286THFPA8038	✓	\$5,467	E3	74.0/37.0	507	38.98	BP
	1200	230/460	TEBC	326TC	Y584	326THFPA8086		\$9,574	E3	80.4/40.2	550	41.91	B,BP
40	1800	230/460	TEFC	324T	Y571	324THFPA8028	✓	\$5,252	E3	100/50.0	545	30.71	
	1800	230/460	TEBC	324TC	Y513	324THFPA8038	✓	\$6,549	E3	100/50.0	531	40.41	BP
	1200	230/460	TEBC	364TC	Y585	364THFS8391		\$11,549	E3	107/53.5	1011	42.67	BP
50	1800	230/460	TEFC	326T	Y572	326THFS8028	✓	\$6,497	E3	121/60.5	765	32.44	
	1800	230/460	TEBC	326TC	Y514	326THFPA8038	✓	\$7,508	E3	120/60.0	686	41.91	BP
	1200	230/460	TEBC	365TC	Y586	365THFS8380		\$13,845	E3	130/65.0	1081	43.78	BP
60	1800	230/460	TEFC	364T	Y573	364THFS8036	✓	\$8,375	E3	147/73.5	987	33.70	
	1800	230/460	TEBC	364TC	Y515	364THFS8046	✓	\$9,191	E3	147/73.5	1062	42.67	BP
	1200	230/460	TEBC	404TC	Y587	404THFS8092		\$15,358	E3	142/71.0	1339	48.22	BP
75	1800	230/460	TEFC	365T	Y574	365THFS8036	✓	\$9,487	E3	184/92.0	1061	34.69	
	1800	230/460	TEBC	365TC	Y516	365THFS8046	✓	\$10,987	E3	180/90.0	1129	43.67	BP
	1200	230/460	TEBC	405TC	Y588	405THFS8378	✓	\$18,713	E3	180/90.0	1387	49.72	B,BP

Blue shaded areas are Cast Iron Frames

Continued on next page.

# Inverter (Vector) Duty: Blue Max® 2000 2000:1 Constant Torque, Totally Enclosed, Three Phase

## Rigid Base and C-Face Footed (Rigid Base)

HP	RPM	VOLTS	ENCL	FRAME	CAT. NO.	MODEL NO.	STOCK	LIST PRICE	MULT. SYMB.	F.L. AMPS	WEIGHT	"C" DIM.	FOOT NOTES
100	1800	230/460	TEFC	405T	Y575	405THFS8036	✓	\$12,838	E3	230/115	1308	39.32	
	1800	230/460	TEBC	405TC	Y517	405THFS8046	✓	\$15,337	E3	230/115	1529	49.72	BP
	1200	230/460	TEBC	444TC	Y589	444THFN8384	✓	\$21,478	E3	250/125	2117	52.72	BP
125	1800	460	TEFC	444T	Y576	444THFN8036	✓	\$16,896	E3	143	2053	43.27	
	1800	460	TEBC	444T	Y518	444THFN8046	✓	\$19,545	E3	138	2010	52.72	B,BP
150	1800	460	TEFC	445T	Y577	445THFN8036	✓	\$19,507	E3	170	2247	45.27	
	1800	460	TEBC	445T	Y519	445THFN8046	✓	\$22,155	E3	170	2310	54.72	BP
200	1800	460	TEFC	445T	Y578	445THFN8040	✓	\$23,547	E3	230	2388	45.27	
	1800	460	TEBC	445T	Y520	445THFN8050	✓	\$26,195	E3	230	2430	54.72	BP
250	1800	460	TEFC	449T	Y579	449THFS8036	✓	\$29,330	E3	280	2900	53.89	CT
	1800	460	TEBC	449T	Y531	449THFS8046	✓	\$32,811	E3	295	2991	63.21	BP
300	1800	460	TEFC	449T	Y580	449THFS8037	✓	\$33,396	E3	330	3077	53.89	CT
	1800	460	TEBC	449T	Y532	449THFS8047	✓	\$36,876	E3	327	2950	63.21	BP
350	1800	460	TEBC	449T	Y533	449THFS8048	✓	\$40,358	E3	385	3099	63.21	BP

Blue shaded areas are Cast Iron Frames

# Inverter (Vector) Duty: Blue Max® 2000 Hazardous Duty™ (with Encoder) 2000:1 Constant Torque, Explosion Proof, Three Phase Class I and II (gases and dust), Groups C (as noted), D, F & G, TENV

## Applications:

Designed for industrial applications with Vector Drives where up to a 2000:1 constant torque speed range and/or precise speed or torque regulation is required, including positioning equipment. Used in dirty, dusty or caustic environments where cast iron construction is required, and installed in hazardous environments as defined by the motor's explosion proof class and group rating. Consult the National Electrical Code and your local regulations for the proper selection of motors in hazardous locations.

## Features:

- BEI H38 explosion proof encoder 1024 ppr, Class I Groups C & D, Class II Groups E, F, G included
- MAX GUARD® Class F insulation system
- Constant torque operation from 0 to base speed on vector drive
- Constant HP operation up to twice base speed
- Continuous duty at 40°C ambient
- Optimized for operation with IGBT inverter (NEMA Design A)
- Normally closed thermostats (one per phase, Class F)
- Ball Bearings
- Cast iron frame and brackets
- F1 standard, NOT field reversible to F2
- UL Listed File No. E12044, MC228275
- CSA Certified File No. LR47504, MC236833
- Meets temperature code T3B
- Three year warranty



## C-Face Footed (Rigid Base)

HP	RPM	VOLTS	ENCL	FRAME	CAT. NO.	MODEL NO.	STOCK	LIST PRICE	MULT. SYMB.	F.L. AMPS	WEIGHT	"C" DIM.	FOOT NOTES
1	1800	230/460	143TC	TSTAT	Y978	143THEN8034	✓	\$5,810	E3	3.0/1.5	86	21.44	CD
2	1800	230/460	145TC	TSTAT	Y979	145THEN8034	✓	\$5,932	E3	5.8/2.9	90	21.44	CD
3	1800	230/460	182TC	TSTAT	Y980	182THES8048	✓	\$6,123	E3	8.2/4.1	117	24.82	CD
5	1800	230/460	213TC	TSTAT	Y981	213THES8053	✓	\$6,442	E3	13.0/6.5	240	27.42	
7 1/2	1800	230/460	254TC	TSTAT	Y982	254THEN8058	✓	\$7,326	E3	22/11	344	30.20	CD
10	1800	230/460	254TC	TSTAT	Y983	254THEN8059	✓	\$7,675	E3	27.0/13.5	376	30.20	CD
15	1800	230/460	256TC	TSTAT	Y984	256THEN17031	✓	\$8,024	E3	36.0/18.0	432	31.95	CD
20	1800	230/460	284TC	TSTAT	Y985	284THEN8032	✓	\$8,857	E3	53/26.5	555	33.16	CD

Blue shaded areas are Cast Iron Frames

# Inverter (Vector) Duty: Blue Max® 2000 Brakemotors 2000:1 Constant Torque, TENV, Three Phase

## Applications:

Designed for vector applications where up to a 2000:1 constant torque speed range is required. For use on Conveyors, Machine tools, Cranes, Hoists, and other industrial machinery requiring quick stop and/or holding torque.



## Features:

- MAX GUARD® Class F insulation system
- Constant torque operation from 0 to base speed on vector drive
- Constant HP operation to twice base speed
- Optimized for operation with IGBT inverter (NEMA Design A)
- Normally closed thermostats (one per phase, Class F)
- Ball Bearings
- Continuous duty at 40°C ambient
- Will accept encoder through Mod Central (see mod 24 for encoder mounting)
- Stearns brakes, 56 series through 15 Lb-Ft, 87 series, 25 Lb-Ft and larger
- Includes 140% rated spring-set self-adjusting NEMA 2 disk brake (Brake coil voltage matches motor)
- Universal mounting up to 15 Lb-Ft, (see comment below and Mod Central for vertical mounting)
- Horizontal mounting (see comment below and Mod Central for vertical mounting)
- UL Recognized, CSA Certified, and CE Mark
- Three year warranty (brake disks are exempt)



## C-Face Footed (Rigid Base)

HP	RPM	VOLTS	FRAME	CAT. NO.	MODEL NO.	STOCK	LIST PRICE	MULT. SYMB.	F.L. AMPS	WEIGHT	"C" DIM.	TORQUE RATING (Lb/Ft)
1	1800	230/460	143TC	Y986	143THTN8036	✓	\$1,813	E3	3.0/1.5	72	17.00	6
2	1800	230/460	145TC	Y987	145THTN8043	✓	\$2,019	E3	6.0/3.0	83	18.00	10
3	1800	230/460	182TC	Y988	182THTS8048	✓	\$2,644	E3	8.2/4.1	118	19.67	15
5	1800	230/460	184TC	Y989	184THTS8056	✓	\$3,187	E3	13.4/6.7	161	25.58	25
7 1/2	1800	230/460	213TC	Y990	213THTS8071	✓	\$3,994	E3	21.0/10.5	256	27.58	35
10	1800	230/460	215TC	Y991	215THTS8071	✓	\$4,746	E3	26.0/13.0	302	28.83	50
15	1800	230/460	254TC	Y992	254THTNA8071	✓	\$6,031	E3	40.5/20.2	384	31.53	75
20	1800	230/460	256TC	Y993	256THTNA8071	✓	\$7,994	E3	52.0/26.0	427	33.28	105

Blue shaded areas are Cast Iron Frames

## 1024 ppr Encoders through MOD Central

Multiplier Symbol E3

BRAND	MODEL	CAT. NO.	KIT NUMBER	STOCK	LIST (KIT ONLY)	LIST (INSTALLED)	FITS BRAKEMOTOR CAT. NO.	WEIGHT
Avtron	AV56	A748	KIT M561024BRK-140	✓	\$2,283	\$2,619	Y986, Y987	4
		A749	KIT M561024BRK-182	✓	\$2,283	\$2,619	Y988	4
	M85	A750	KIT M851024BRK-184	✓	\$3,080	\$3,416	Y989	5
		A751	KIT M851024BRK-210	✓	\$3,080	\$3,416	Y990, Y991	8
NorthStar	SL56	A752	KIT M851024BRK-250	✓	\$3,080	\$3,416	Y992, Y993	8
		A786	KIT LKSR-CFACE	✓	\$2,510	\$2,846	Y986, Y987	4
	SL85	A789	KIT SL561024-182NV	✓	\$2,510	\$2,846	Y988	4
		A790	KIT SL851024-184NV	✓	\$3,080	\$3,416	Y989	8
		A791	KIT SL851024-210NV	✓	\$3,080	\$3,416	Y990, Y991	8
		A792	KIT SL851024-250NV	✓	\$3,080	\$3,416	Y992, Y993	8

## Vertical Modification Kit (Stearns 87,000 series)

Includes required hardware to accommodate vertical above (shaft down) or vertical below (shaft up) mounting.

TORQUE RATING (Lb/Ft)	MOUNTING		CAT. NO.	STOCK	MODEL NO.	LIST (KITS ONLY)	LIST INSTALLED	WEIGHT
	SHAFT UP	SHAFT DOWN						
25,35	Not req'd	Required	A157	✓	KIT VRT87BRK	\$420	\$552	3
50,75,105	Required	Required						

# SyMax™ Permanent Magnet AC Motors

## TENV and TEFC Three Phase



Commercial, Rolled Steel frame (NEMA 56 frame models)

Industrial, Cast Iron frame (NEMA 182-286T frame models)

### Features:

- Meets or exceeds NEMA Premium® (IE3)
- Class F MAX GUARD® insulation system
- Operational to 20:1 Constant Torque open-loop (1000:1 closed-loop)
- IP43 ingress protection (IP54 or IP55 available)
- Totally Enclosed, Non-Ventilated
- Sealed ball bearing
- High power density, low weight design
- Provisions for optional "BCP" (Bearing Current Protection)
- Three year warranty
- Requires Drive for Operation

### Features:

- Ultra Efficient™ Premium-Plus exceeds NEMA Premium® (IE4)
- Class H MAX GUARD® insulation system
- Cast iron construction for rigidity and reduced vibration
- IP54 ingress protection (IP55 or IP56 available)
- Premium Severe Duty, TEFC
- Normally closed thermostats (one per phase, Class F)
- High power density, low weight design
- UL, CSA and CE
- Optional terminal block shown
- Provisions for optional "BCP" (Bearing Current Protection)
- Three year warranty
- Requires Drive for Operation

HP	RPM	VOLTS	NEMA FRAME	TORQUE (LB-FT)	CAT. NO.	MODEL NO.	STOCK	LIST PRICE	MULT. SYMB.	NOM. EFF.	F.L. AMPS	WEIGHT	"C" DIM.	FOOT NOTES
1/2	1800	230/460	56C	1.5	<b>SY001</b>	056PNRA10100	√	\$671	PM1	83.5	1.86/0.93	13	7.82	
1	1800	230/460	56C	2.9	<b>SY003</b>	056PNRA10101	√	\$780	PM1	85.3	3.55/1.78	18	8.82	
1 1/2	1800	230/460	56C	4.4	<b>SY004</b>	056PNRA10102	√	\$950	PM1	86.1	5.48/2.74	23	9.82	
2	1800	230/460	56C	5.8	<b>SY005</b>	056PNRA10103	√	\$1,275	PM1	86.5	6.32/3.16	28	10.82	
3	1800	460	182TC	8.8	<b>SY006</b>	182TPFSA10094	√	\$2,056	PM1	91.7	3.8	99	15.88	
5	1800	460	184TC	14.6	<b>SY007</b>	184TPFSA10095	√	\$2,281	PM1	91.7	6.4	108	15.88	
7.5	1800	460	213TC	21.9	<b>SY008</b>	213TPFSA10096	√	\$2,648	PM1	93.0	9.4	152	19.63	
10	1800	460	215TC	29.2	<b>SY009</b>	215TPFSA10097	√	\$3,136	PM1	93.6	11.8	166	19.63	
15	1800	460	254TC	43.8	<b>SY010</b>	254TPFSA10088	√	\$3,798	PM1	94.5	18.5	204	25.40	
20	1800	460	256TC	58.3	<b>SY011</b>	256TPFSA10087	√	\$4,346	PM1	95.0	22.9	253	25.40	
25	1800	460	284TC	72.9	<b>SY012</b>	284TPFSA10112	√	\$5,288	PM1	95.0	28.1	396	27.93	
30	1800	460	286TC	87.5	<b>SY013</b>	286TPFSA10090	√	\$6,001	PM1	95.4	33.7	416	27.93	

Catalog numbers (Cat No.) highlighted in bold blue have efficiency levels that meet EISA requirements

Blue shaded areas are Cast Iron Frames

INVERTER DUTY "MAX" Family of Motors

# DC Permanent Magnet SCR Rated, Totally Enclosed C-Face Footed (Removable Base)

## Features:

- Class F insulation
- NEMA C-Face with removable rigid base
- Oversized brushes for extra long life
- Permanently lubricated sealed ball bearings
- Linear speed/torque characteristics over entire speed range
- High starting torque, high peak current capability
- Usable on PWM type DC adjustable speed drives at higher HP rating
- Easy brush access with unique brush holder design
- UL Recognized and CSA Certified



HP	RPM	DC VOLTS	FRAME	ENCL.	CAT. NO.	MODEL NO.	STOCK	LIST PRICE	MULT. SYMB.	C.T. SPEED RANGE	F.L. AMPS	PWM HP RATING	WEIGHT	"C" DIM.	FOOT NOTES
1/4	1750	90	56C	TEFC	Z602	056E17F1001	√	\$498	D1	2:1	2.5	0.40	22	10.81	
	1750	180	56C	TEFC	Z603	056E17F1002	√	\$498	D1	2:1	1.4	0.50	22	11.31	
1/3	1750	90	56C	TEFC	Z604	056E17F1003	√	\$528	D1	2:1	3.5	0.50	24	11.31	
	1750	180	56C	TEFC	Z605	056E17F1004		\$528	D1	2:1	1.7	0.50	22	11.31	
1/2	1750	90	56C	TEFC	Z606	056E17F1005	√	\$588	D1	2:1	5.0	0.70	26	11.81	
	1750	180	56C	TEFC	Z607	056E17F1006	√	\$588	D1	2:1	2.5	0.56	25	11.81	
3/4	1750	90	56C	TEFC	Z610	056E17F1007	√	\$714	D1	2:1	7.6	1.00	34	13.81	
	1750	180	56C	TEFC	Z611	056E17F1008	√	\$714	D1	2:1	3.8	1.00	34	13.81	
1	1750	90	56C	TEFC	Z612	056E17F2005	√	\$872	D1	2:1	10.0	1.25	45	14.81	
	1750	180	56C	TEFC	Z613	056E17F2006	√	\$872	D1	2:1	5.0	1.25	41	14.81	
1 1/2	1750	180	56C	TEFC	Z614	056E17F2007	√	\$1,090	D1	2:1	7.6	1.75	52	16.81	
	1750	180	145TC	TEFC	Z615	145TEFR5326	√	\$1,656	D1	2:1	7.5	1.50	74	18.34	
2	1750	180	145TC	TEFC	Z616	145TEFR5327	√	\$1,975	D1	2:1	9.5	2.00	86	19.34	
	1750	180	182/145TC	TEFC	Z617	182TEFR5326	√	\$1,975	D1	2:1	9.5	2.00	83	19.34	84



## SCR PMDC motors on PWM power supplies

Pulse width modulated DC controls have a voltage output similar to pure direct current which has a form factor of 1.05. SCR thyristor drives have a form factor of 1.40. Marathon Motors's non-Explosion Proof PMDC, SCR-rated motors can also be used with PWM controls, and due to the lower form factor and the resultant lower heating in the motor, their rating can be increased as indicated above. Operation on PWM controls will also result in quieter operation and longer brush life.

# Washdown, DC Permanent Magnet SCR Rated, Totally Enclosed C-Face Footed (Removable Base)

## Features:

- Class F insulation
- NEMA C-Face with removable rigid base
- Oversized brushes for extra long life
- Doubled sealed, oversized ball bearings
- Corrosion resistant 303 stainless steel shaft
- "V" ring Forsheda seals
- High temperature, moisture resistant lubricant
- Exterior and interior components protected with enamel & polyester compounds
- Aluminum conduit box, threaded and gasketed
- Drains at 3:00, 6:00, 9:00 and 12:00 locations
- Sealed machine fits
- Stainless steel nameplate
- USDA approved white epoxy paint
- UL Recognized and CSA Certified



HP	RPM	DC VOLTS	FRAME	ENCL.	CAT. NO.	MODEL NO.	STOCK	LIST PRICE	MULT. SYMB.	C.T. SPEED RANGE	F.L. AMPS	PWM HP RATING	WEIGHT	"C" DIM.	FOOT NOTES
1/4	1750	90	56C	TENV	Z630	056E17V2001	✓	\$639	D1	20:1	2.7	0.30	24	10.69	
1/3	1750	90	56C	TENV	Z631	056E17V2002		\$676	D1	20:1	3.5	0.56	30	11.69	
1/2	1750	90	56C	TENV	Z634	056E17V2003	✓	\$757	D1	20:1	4.9	0.75	37	13.69	
		180	56C	TENV	Z635	056E17V2004	✓	\$757	D1	20:1	2.4	0.70	41	13.69	d
3/4	1750	90	56C	TENV	Z636	056E17V2005	✓	\$918	D1	20:1	7.0	1.25	51	14.67	
		180	56C	TENV	Z637	056E17V2006		\$918	D1	20:1	3.5	1.25	50	14.17	
1	1750	90	56C	TEFC	Z638	056E17W2001	✓	\$1,120	D1	2:1	10.0	1.25	45	14.81	
		180	56C	TEFC	Z639	056E17W2002	✓	\$1,120	D1	2:1	5.0	1.25	41	14.81	
1 1/2	1750	180	56C	TEFC	Z641	056E17W2003		\$1,430	D1	2:1	7.6	1.75	51	16.81	

# Low Voltage, DC Permanent Magnet TENV and TEFC

## C-Face Footed (Removable Base)

### Features:

- Permanently lubricated sealed ball bearings
- NEMA C-Face with removable base
- Class H insulation
- Easy brush access with unique brush holder design
- Oversized brushes for extra long life
- High starting torque
- U.L. Recognized and CSA Certified

### Applications

Low voltage permanent magnet DC motors are suitable for installations having batteries or generator supplied low voltage DC.



HP	RPM	DC VOLTS	FRAME	ENCL.	CAT. NO.	MODEL NO.	STOCK	LIST PRICE	MULT. SYMB.	F.L. AMPS	WEIGHT	"C" DIM.	FOOT NOTES
1/4	1750	12	56C	TENV	Z660	056E17T2001	✓	\$535	D1	21.0	22	10.27	85
1/3	1750	12	56C	TENV	Z662	056E17T2002	✓	\$589	D1	27.0	24	10.77	d,85
		24	56C	TENV	Z663	056E17T2003	✓	\$563	D1	13.5	23	10.77	85
1/2	1750	12	56C	TENV	Z664	056E17T2004	✓	\$612	D1	39.0	30	11.77	85
		24	56C	TENV	Z665	056E17T2005		\$585	D1	20.0	28	11.77	85
3/4	1750	12	56C	TEFC	Z666	056E17F2008	✓	\$676	D1	58.0	35	13.81	85
		24	56C	TEFC	Z667	056E17F2009	✓	\$611	D1	29.0	32	12.81	85
1	1750	12	56C	TEFC	Z668	056E17F2010	✓	\$805	D1	80.0	39	13.81	
		24	56C	TEFC	Z669	056E17F2011	✓	\$742	D1	39.0	34	13.81	85

# Globetrotter® IEC (Metric) Frame, Three Phase

## Totally Enclosed, B3 Mounting, Rigid Base

### Applications:

For use on fans, pumps, compressors, conveyors, and other equipment requiring IEC dimensions and electrical standards. The Globetrotter is not only designed to International standards but meets NEMA performance and efficiency standards making it suitable for requirements worldwide.

### Features:

- Meets IE3 European and NEMA Premium® efficiencies
- Aluminum (63-90 frame) or Cast Iron (100-315 frame) frame construction
- Nameplated 60/50 hertz at same HP, above 90 frame is 60/50 Hz at next lower HP
- MAX GUARD® Class F Insulation, Class B rise @ rated KW
- IP55 weatherproof enclosure
- Rotatable/Removable Base (63-90 frame)
- Wye Start-Delta Run on 160 Frame and larger
- 10:1 Variable Torque, Constant Torque speed range as noted
- Top Mounted/Oversized gasketed terminal box
- Meets IEEE45, IEC60092 & USCG CFR46 Marine Duty (63-90 frame "Below Deck")
- 1.15 Service Factor on 60 Hz sine wave, 1.0 SF or VFD



**IP55**



- IEC Design "N" with NEMA "B" Torques
- Terminal Blocks, Stud Type, Zero Creepage
- Kits or MOD Central for B3/B14 mounting, see Accessories section
- Meets IEC 34 electrical standards
- Meets IEC 72 dimensions and tolerances
- CE Marked
- 1 Year Warranty

CONSULT  
MARATHON MOTORS  
FOR SPECIAL IEC  
MOTORS

### Multiplier Symbol F4

Suitable for use on VFD per guidelines on page 17.

HP/ kW	RPM 60/50 HZ	60 HZ VOLTS	50 HZ VOLTS	IEC FRAME	CAT. NO.	MODEL NO.	STOCK	C.T. SPEED RANGE*	LIST PRICE	NOM. EFF.	60 HZ F.L. AMPS	WEIGHT	IEC "L" DIM. (mm)	FOOT NOTES	B5/FF FLANGE
1/4-.18	3600/3000	230/460	200/400	63	R300	63T34FH5301	✓	20:1	\$187	72.0	0.8/0.4	11	217		A569
	3600/3000	575	480	63	R400	63T34FH5303	✓	20:1	\$187	72.0	0.3	11	217		A569
	1800/1500	230/460	200/400	63	R301	63T17FH5326	✓	20:1	\$195	68.0	1.0/0.5	12	217		A569
	1800/1500	575	480	63	R401	63T17FH5327	✓	20:1	\$195	68.0	0.4	12	217		A569
	1200/1000	230/460	200/400	71	R302	71T11FH5376	✓	20:1	\$332	64.0	1.2/0.6	13	240		A570
1/3-.25	3600/3000	230/460	200/400	63	R303	63T34FH5302	✓	20:1	\$219	72.0	1.1/.55	12	217		A569
	3600/3000	575	480	63	R403	63T34FH5304	✓	20:1	\$219	72.0	0.4	12	217		A569
	1800/1500	230/460	200/400	71	R304	71T17FH5326	✓	20:1	\$228	68.0	1.4/.7	14	240		A570
	1800/1500	575	480	71	R404	71T17FH5330	✓	20:1	\$228	68.0	0.6	14	240		A570
	1200/1000	230/460	200/400	80	R305	80T11FH5376	✓	20:1	\$357	70.0	1.3/.65	20	282		A571
1/2-.37	3600/3000	230/460	200/400	71	R306	71T34FH5301	✓	20:1	\$233	74.0	1.6/.8	14	240		A570
	3600/3000	575	480	71	R406	71T34FH5303	✓	20:1	\$233	74.0	0.7	14	240		A570
	1800/1500	230/460	200/400	71	R307	71T17FH5327	✓	20:1	\$237	74.0	1.8/.9	15	240		A570
	1800/1500	575	480	71	R407	71T17FH5331	✓	20:1	\$237	74.0	0.7	16	240		A570
	1200/1000	230/460	200/400	80	R308	80T11FH5377	✓	20:1	\$372	72.0	1.9/.95	22	282		A571
3/4-.55	3600/3000	230/460	200/400	71	R309	71T34FH5302	✓	20:1	\$245	74.0	2.4/1.2	16	240		A570
	3600/3000	575	480	71	R409	71T34FH5304	✓	20:1	\$245	74.0	0.9	16	240		A570
	1800/1500	230/460	200/400	80	R310	80T17FH5326	✓	20:1	\$258	74.0	2.5/1.25	21	282		A571
	1800/1500	575	480	80	R410	80T17FH5330	✓	20:1	\$258	74.0	1.0	22	282		A571
	1200/1000	230/460	200/400	80	R311	80T11FH5378	✓	20:1	\$400	72.0	2.7/1.35	25	282		A571
1-.75	3600/3000	230/460	200/400	80	R312	80T34FH5301	✓	20:1	\$278	75.5	2.8/1.4	24	282		A571
	3600/3000	575	480	80	R412	80T34FH5305	✓	20:1	\$278	75.5	1.1	24	282		A571
	1800/1500	230/460	200/400	80	R313	80T17FH5327	✓	20:1	\$282	80.0	3.2/1.6	29	282		A571
	1800/1500	575	480	80	R413	80T17FH5331	✓	20:1	\$282	80.0	1.4	28	282		A571
	1200/1000	230/460	200/400	90S	<b>R314A</b>	90ST11FH6376	✓	20:1	\$486	82.5	3.3/1.7	39	326		A572
1 1/2-1.1	3600/3000	230/460	200/400	80	<b>R315</b>	80T34FH5302	✓	20:1	\$287	84.0	4.0/2.0	30	282		A571
	3600/3000	575	480	80	<b>R415</b>	80T34FH5303	✓	20:1	\$287	84.0	1.6	29	282		A571
	1800/1500	230/460	200/400	90S	<b>R316A</b>	90ST17FH6326	✓	20:1	\$369	86.5	4.6/2.3	40	326		A572
	1800/1500	575	480	90S	<b>R416A</b>	90ST17FH6327	✓	20:1	\$369	86.5	1.8	43	326		A572
	1200/1000	230/460	200/400	100L	<b>R317</b>	100LTFC6586	✓	2:1	\$576	87.5	5.5/10	82	380		A554A
2-1.5	3600/3000	230/460	200/400	90S	<b>R318A</b>	90ST34FH6301	✓	20:1	\$384	85.5	5.2/2.6	37	326		A572
	3600/3000	575	480	90S	<b>R418A</b>	90ST34FH6302	✓	20:1	\$384	85.5	2.1	37	326		A572
	1800/1500	230/460	200/400	90L	<b>R319A</b>	90LT17FH6326	✓	20:1	\$396	86.5	5.8/2.9	44	326		A572
	1800/1500	575	480	90L	<b>R419A</b>	90LT17FH6327	✓	20:1	\$396	86.5	2.4	44	326		A572
	1200/1000	230/460	200/400	100L	<b>R320A</b>	100LTFC6576	✓	2:1	\$619	88.5	7.6/3.8	99	415		A554A
1200/1000	575	480	100L	<b>R420A</b>	100LTFC6577	✓	2:1	\$619	87.5	2.1	98	415		A554A	

Catalog numbers (Cat No.) highlighted in bold blue have efficiency levels that meet EISA requirements

Blue shaded areas are Cast Iron Frames

\* Requires nameplate modification

Continued on next page.



# Globetrotter® IEC (Metric) Frame, Three Phase

## Totally Enclosed, B3 Mounting, Rigid Base

Multiplier Symbol F4

IEC MOTORS

HP/ kW	RPM 60/50 HZ	60 HZ VOLTS	50 HZ VOLTS	IEC FRAME	CAT. NO.	MODEL NO.	STOCK	C.T. SPEED RANGE*	LIST PRICE	NOM. EFF.	60 HZ F.L. AMPS	WEIGHT	IEC "L" DIM. (mm)	FOOT NOTES	B5/FF FLANGE
3-2.2	3600/3000	230/460	200/400	90L	<b>R321A</b>	90LT34FH6301	✓	20:1	\$553	86.5	7.2/3.6	42	326		A572
	3600/3000	575	480	90L	<b>R421A</b>	90LT34FH6302	✓	20:1	\$553	86.5	2.9	42	326		A572
4-3	1800/1500	230/460	200/400	100L	<b>R322A</b>	100LTFC6526	✓	20:1	\$600	89.5	9.0/4.5	84	415		A554A
	1800/1500	575	480	100L	<b>R422A</b>	100LTFC6527	✓	20:1	\$600	89.5	3.6	84	415		A554A
	1200/1000	230/460	200/400	112M	<b>R323A</b>	112MTFC6576	✓	20:1	\$874	89.5	9.0/4.5	100	468		A554A
	3600/3000	230/460	200/400	100L	<b>R351A</b>	100LTFC6501	✓	20:1	\$640	87.5	9.2/4.6	71	415		A554A
5 1/2-4	3600/3000	575	480	100L	<b>R451A</b>	100LTFC6502	✓	20:1	\$640	87.5	3.7	71	415		A554A
	1800/1500	230/460	200/400	100L	<b>R352A</b>	100LTFC6536	✓	20:1	\$651	89.5	11.0/5.5	84	415		A554A
	1800/1500	575	480	100L	<b>R452A</b>	100LTFC6537	✓	20:1	\$651	89.5	4.4	84	415		A554A
	1200/1000	230/460	200/400	132S	<b>R353A</b>	132STFC6586	✓	2:1	\$1,058	89.5	13.0/6.5	154	464		A556A
	3600/3000	230/460	200/400	112M	<b>R324A</b>	112MTFC6511	✓	20:1	\$824	87.5	12.8/6.4	104	410		A555B
	3600/3000	575	480	112M	<b>R424A</b>	112MTFC6512	✓	20:1	\$824	87.5	5.1	104	410		A555B
7 1/2-5.5	1800/1500	230/460	200/400	112M	<b>R325A</b>	112MTFC6536	✓	20:1	\$794	89.5	14.0/7.0	104	410		A555B
	1800/1500	575	480	112M	<b>R425A</b>	112MTFC6537	✓	20:1	\$794	89.5	5.6	104	410		A555B
	1200/1000	230/460	200/400	132M	<b>R326A</b>	132MTFC6586	✓	2:1	\$1,221	89.5	17/8.5	176	502		A556A
	3600/3000	230/460	200/400	132S	<b>R327A</b>	132STFC6501	✓	20:1	\$1,033	90.2	17.6/8.8	152	464		A550
	3600/3000	575	480	132S	<b>R427A</b>	132STFC6503	✓	20:1	\$1,033	90.2	7.0	152	464		A550
	1800/1500	230/460	200/400	132S	<b>R328A</b>	132STFC6526	✓	20:1	\$998	91.7	19.6/9.8	150	464		A556A
10-7.5	1800/1500	575	480	132S	<b>R428A</b>	132STFC6527	✓	20:1	\$998	91.7	7.8	105	464		A556A
	1200/1000	230/460	200/400	132M	<b>R329A</b>	132MTFC6587	✓	2:1	\$1,469	91.0	23.4/11.7	180	502		A556A
	3600/3000	230/460	200/400	132S	<b>R330A</b>	132STFC6502	✓	20:1	\$1,105	90.2	23.2/11.6	163	464		A550
	3600/3000	575	480	132S	<b>R430A</b>	132STFC6504	✓	20:1	\$1,105	90.2	9.3	163	464		A550
	1800/1500	230/460	200/400	132M	<b>R331A</b>	132MTFC6536	✓	2:1	\$1,225	91.7	26.0/13.0	174	502		A556A
	1800/1500	575	480	132M	<b>R431A</b>	132MTFC6537	✓	2:1	\$1,225	91.7	10.4	174	502		A556A
15-11	1200/1000	230/460	200/400	160M	<b>R332A</b>	160MTFC6586	✓	2:1	\$1,905	91.0	28.0/14.0	251	615	YD	A557
	3600/3000	230/460	200/400	160M	<b>R333A</b>	160MTFC6511	✓	2:1	\$1,790	91.7	35.2/17.6	260	600	YD	A551
	1800/1500	230/460	200/400	160M	<b>R334A</b>	160MTFC6536	✓	10:1	\$1,756	92.4	37.8/18.9	264	600	YD	A557
	1200/1000	230/460	200/400	160L	<b>R335A</b>	160LTFC6588	✓	2:1	\$2,445	91.7	38.8/19.4	330	675	YD	A557
20-15	3600/3000	230/460	200/400	160M	<b>R336A</b>	160MTFC6512	✓	10:1	\$2,100	91.7	46.8/23.4	269	600	YD	A551
	1800/1500	230/460	200/400	160L	<b>R337A</b>	160LTFC6538	✓	2:1	\$2,214	93.0	47.0/23.5	311	600	YD	A557
	1200/1000	230/460	200/400	180L	<b>R338A</b>	180LTFC6588	✓	2:1	\$3,429	91.7	54.0/27.0	385	718	YD	A558
25-18.5	3600/3000	230/460	200/400	160L	<b>R339A</b>	160LTFC6513	✓	2:1	\$2,556	91.7	57.6/28.8	319	645	YD	A551
	1800/1500	230/460	200/400	180M	<b>R340A</b>	180MTFC6536	✓	20:1	\$2,814	93.6	59.2/29.6	381	680	YD	A558
	1200/1000	230/460	200/400	200L	<b>R341A</b>	200LTFC6588	✓	2:1	\$4,300	93.0	63.0/31.5	467	775	YD	A559
30-22	3600/3000	230/460	200/400	180M	<b>R342A</b>	180MTFC6511	✓	2:1	\$3,038	92.4	68.8/34.4	355	680	YD	A552
	1800/1500	230/460	200/400	180L	<b>R343A</b>	180LTFC6538	✓	20:1	\$3,163	93.6	69.2/34.6	427	718	YD	A558
	1200/1000	230/460	200/400	200L	<b>R344A</b>	200LTFC6589	✓	2:1	\$4,871	93.0	76/38	467	750	YD	A559
40-30	3600/3000	230/460	200/400	200L	<b>R345A</b>	200LTFC6511	✓	20:1	\$4,325	92.4	89.6/44.8	522	750	YD	A553
	1800/1500	230/460	200/400	200L	<b>R346A</b>	200LTFC6538	✓	2:1	\$4,656	94.1	95/47.5	531	750	YD	A559
	1200/1000	230/460	200/400	225M	<b>R347A</b>	225MTFC6586	✓	2:1	\$7,319	94.1	100/50	633	837	YD	A580
50-37	3600/3000	230/460	200/400	200L	<b>R348A</b>	200LTFC6513	✓	10:1	\$5,673	93.0	111/55.7	546	750	YD	A553
	1800/1500	230/460	200/400	225S	<b>R349A</b>	225STFC6526	✓	10:1	\$6,460	94.5	117/58.8	632	812	YD	A580
	1200/1000	230/460	200/400	250M	<b>R350A</b>	250MTFC6586	✓	2:1	\$10,259	94.1	125/62.5	655	1350	YD	A594
60-45	3600/3000	230/460	200/400	225M	<b>R500</b>	225MTFC6501	✓	10:1	\$8,794	94.1	134/67.0	590	837	YD	A580
	1800/1500	230/460	200/400	225M	<b>R501</b>	225MTFC6526	✓	10:1	\$9,708	95.0	138/69.0	1005	837	YD	A580
	1200/1000	230/460	200/400	280S	<b>R502</b>	280STFC6586	✓	2:1	\$12,954	95.0	152/76.0	975	975	YD	A596
75-55	3600/3000	230/460	200/400	250M	<b>R503</b>	250MTFC6501	✓	2:1	\$12,069	93.6	170/85.0	937	1350	YD	A594
	1800/1500	230/460	200/400	250M	<b>R504</b>	250MTFC6526	✓	2:1	\$11,361	95.4	174/87.0	1030	922	YD	A594
	1200/1000	230/460	200/400	280M	<b>R505</b>	280MTFC6588	✓	2:1	\$14,278	94.5	190/95.0	1100	1026	YD	A596
100-75	3600/3000	230/460	200/400	280S	<b>R506</b>	280STFC6501	✓	2:1	\$14,435	94.1	222/111	1016	975	YD	A596
	1800/1500	230/460	200/400	280S	<b>R507</b>	280STFC6526	✓	2:1	\$13,118	95.4	226/113	1025	975	YD	A596
	1200/1000	230/460	200/400	315S	<b>R508</b>	315STFC6588	✓	2:1	\$17,882	95.0	234/117	1300	1240	YD	A598

Catalog numbers (Cat No.) highlighted in bold blue have efficiency levels that meet EISA requirements

Blue shaded areas are Cast Iron Frames

\* Requires nameplate modification

Continued on next page.

# Globetrotter® IEC (Metric) Frame, Three Phase Totally Enclosed, Flange/Base Mounting



## B3/B5 "FF" (D-Flange)

Multiplier Symbol F4

HP/ kW	RPM 60/50 HZ	60 HZ VOLTS	50 HZ VOLTS	IEC FRAME	CAT. NO.	MODEL NO.	STOCK	C.T. SPEED RANGE†	LIST PRICE	NOM. EFF.	60 HZ F.L. AMPS	WEIGHT	IEC "L" DIM. (mm)	FOOT NOTES
1/4-.18	3600/3000	230/460	200/400	63D	R380	63T34FH5501	✓	20:1	\$215	72.0	0.8/0.4	10	217	
	1800/1500	230/460	200/400	63D	R381	63T17FH5502	✓	20:1	\$222	68.0	1.0/0.5	11	217	
	1200/1000	230/460	200/400	71D	R382	71T11FH5503	✓	20:1	\$382	64.0	1.2/0.6	12	240	
1/3-.25	3600/3000	230/460	200/400	63D	R383	63T34FH5504	✓	20:1	\$249	72.0	1.1/.55	11	217	
	1800/1500	230/460	200/400	71D	R384	71T17FH5505	✓	20:1	\$257	68.0	1.4/.7	13	240	
	1200/1000	230/460	200/400	80D	R385	80T11FH5506	✓	20:1	\$410	70.0	1.3/.65	17	282	
1/2-.37	3600/3000	230/460	200/400	71D	R386	71T34FH5507	✓	20:1	\$255	74.0	1.6/.8	13	240	
	1800/1500	230/460	200/400	71D	R387	71T17FH5508	✓	20:1	\$264	74.0	1.8/.9	14	282	
	1200/1000	230/460	200/400	80D	R388	80T11FH5509	✓	20:1	\$427	72.0	1.9/.95	19	282	
3/4-.55	3600/3000	230/460	200/400	71D	R389	71T34FH5510	✓	20:1	\$270	74.0	2.4/1.2	15	282	
	1800/1500	230/460	200/400	80D	R390	80T17FH5511	✓	20:1	\$288	74.0	2.5/1.25	18	282	
	1200/1000	230/460	200/400	80D	R391	80T11FH5512	✓	20:1	\$452	72.0	2.7/1.35	22	320	
1-.75	3600/3000	230/460	200/400	80D	R392	80T34FH5513	✓	20:1	\$297	75.5	2.8/1.4	21	282	
	1800/1500	230/460	200/400	80D	R393	80T17FH5514	✓	20:1	\$311	80.0	3.2/1.6	26	282	
	1200/1000	230/460	200/400	90SD	<b>R394A</b>	90ST11FH6515	✓	20:1	\$556	82.5	3.3/1.7	35	320	
1 1/2-1.1	3600/3000	230/460	200/400	80D	<b>R395</b>	80T34FH5516	✓	20:1	\$339	84.0	4.0/2.0	30	282	
	1800/1500	230/460	200/400	90SD	<b>R396A</b>	90ST17FH6517	✓	20:1	\$403	86.5	4.6/2.3	37	320	
2-1.5	3600/3000	230/460	200/400	90SD	<b>R397A</b>	90ST34FH6518	✓	20:1	\$439	85.5	5.2/2.6	33	320	
	1800/1500	230/460	200/400	90LD	<b>R398A</b>	90LT17FH6519	✓	20:1	\$451	86.5	5.8/2.9	38	320	
3-2.2	3600/3000	230/460	200/400	90LD	<b>R399A</b>	90LT34FH6520	✓	20:1	\$621	86.5	7.2/3.6	39	320	



## B3/B14 "FT" (C-Face)

HP/ kW	RPM 60/50 HZ	60 HZ VOLTS	50 HZ VOLTS	IEC FRAME	CAT. NO.	MODEL NO.	STOCK	C.T. SPEED RANGE*	LIST PRICE	NOM. EFF.	60 HZ F.L. AMPS	WEIGHT	IEC "L" DIM. (MM)	FOOT NOTES
1/4-.18	3600/3000	230/460	200/400	63C	R360	63T34FH5401	✓	20:1	\$211	72.0	0.8/0.4	10	217	
	1800/1500	230/460	200/400	63C	R361	63T17FH5402	✓	20:1	\$219	68.0	1.0/0.5	11	217	
	1200/1000	230/460	200/400	71C	R362	71T11FH5403	✓	20:1	\$382	64.0	1.2/0.6	12	240	
1/3-.25	3600/3000	230/460	200/400	63C	R363	63T34FH5404	✓	20:1	\$247	72.0	1.1/.55	11	217	
	1800/1500	230/460	200/400	71C	R364	71T17FH5405	✓	20:1	\$250	68.0	1.4/.7	13	240	
	1200/1000	230/460	200/400	80C	R365	80T11FH5406	✓	20:1	\$410	70.0	1.3/.65	17	282	
1/2-.37	3600/3000	230/460	200/400	71C	R366	71T34FH5407	✓	20:1	\$251	74.0	1.6/.8	13	240	
	1800/1500	230/460	200/400	71C	R367	71T17FH5408	✓	20:1	\$261	74.0	1.8/.9	14	282	
	1200/1000	230/460	200/400	80C	R368	80T11FH5409	✓	20:1	\$427	72.0	1.9/.95	19	282	
3/4-.55	3600/3000	230/460	200/400	71C	R369	71T34FH5410	✓	20:1	\$264	74.0	2.4/1.2	15	282	
	1800/1500	230/460	200/400	80C	R370	80T17FH5411	✓	20:1	\$283	74.0	2.5/1.25	18	282	
	1200/1000	230/460	200/400	80C	R371	80T11FH5412	✓	20:1	\$452	72.0	2.7/1.35	22	320	
1-.75	3600/3000	230/460	200/400	80C	R372	80T34FH5413	✓	20:1	\$291	75.5	2.8/1.4	21	282	
	1800/1500	230/460	200/400	80C	R373	80T17FH5414	✓	20:1	\$304	80.0	3.2/1.6	26	282	
	1200/1000	230/460	200/400	90SC	<b>R374A</b>	90ST11FH6415	✓	20:1	\$556	82.5	3.3/1.7	35	320	
1 1/2-1.1	3600/3000	230/460	200/400	80C	<b>R375</b>	80T34FH5416	✓	20:1	\$331	84.0	4.0/2.0	30	282	
	1800/1500	230/460	200/400	90SC	<b>R376A</b>	90ST17FH6417	✓	20:1	\$395	86.5	4.6/2.3	37	320	
2-1.5	3600/3000	230/460	200/400	90SC	<b>R377A</b>	90ST34FH6418	✓	20:1	\$430	85.5	5.2/2.6	33	320	
	1800/1500	230/460	200/400	90LC	<b>R378A</b>	90LT17FH6419	✓	20:1	\$439	86.5	5.8/2.9	38	320	
3-2.2	3600/3000	230/460	200/400	90LC	<b>R379A</b>	90LT34FH6420	✓	20:1	\$621	86.5	7.2/3.6	39	320	

Catalog numbers (Cat No.) highlighted in bold blue have efficiency levels that meet EISA requirements

\* Requires nameplate modification

# Brake Motors, Single Phase

## Totally Enclosed, C-Face Footed (Removable Base)

### Features:

- Fail-safe, spring set Stearns 56 Series brake for holding or stopping
- Brake has manual wear adjustment for longer pad life
- Manual release lever on rear of brake housing
- Brake leads are terminated at the brake
- Universal mounting, no modifications needed
- Brake coil voltage matches motor voltages, see mod section for other brake coils
- Ball bearings, mechanically locked on shaft end
- 1.15 Service Factor (1.0 Service Factor as noted)
- Nameplated 60/50 hertz at next lowest horsepower
- UL Recognized and CSA Certified



HP	RPM	VOLTS	FRAME	CAT. NO.	MODEL NO.	STOCK	LIST PRICE	MULT. SYMB.	F.L. AMPS	WEIGHT	"C" DIM.	BRAKE RATING (Lb/Ft)	FOOT NOTES
1/3	1800	115/208-230	56C	D400	056C17F5352	✓	\$641	E5	6.6/3.1-3.3	33	16.20	3	2,6
1/2	1800	115/208-230	56C	D401	056C17F5353	✓	\$707	E5	8.8/4.2-4.4	34	16.20	3	2,6
3/4	1800	115/208-230	56C	D402	056C17F5354	✓	\$916	E5	11.0/5.4-5.5	38	16.70	6	2,6
1	1800	115/208-230	56C	D403	056C17F5355	✓	\$974	E5	13.4/6.8-6.7	40	17.20	6	2,6
1 1/2	1800	115/208-230	56C	D404	056B17F5330	✓	\$1,028	E5	15.2/8.2-7.6	50	19.04	10	1,6

# Brake Motors, Three Phase

## Totally Enclosed

### Features:

- In addition to the Single Phase Features above:
- Brake has manual wear adjustment for longer pad life
- Brake leads routed through motor conduit box (TENV only)
- Universal mounting, no modifications needed
- CR200 Corona resistant magnet wire (motor can be operated 10:1 variable torque)



### Rigid Base

HP	RPM	VOLTS	FRAME	CAT. NO.	MODEL NO.	STOCK	LIST PRICE	MULT. SYMB.	F.L. AMPS	WEIGHT	"C" DIM.	BRAKE RATING (Lb/Ft)	FOOT NOTES
1/2	1800	230/460	56	K456	5K49KN4573	✓	\$820	E5	1.8/0.9	31	14.06	3	17,N
	1200	230/460	56	K526	5K49MN6369	✓	\$1,131	E5	2.4/1.2	33	15.56	3	17,N
3/4	1800	230/460	56	K458	5K49PN4564	✓	\$1,014	E5	2.5/1.25	36	14.56	6	17,N
1	1800	230/460	56	K459	5K49UN4569	✓	\$1,173	E5	3.2/1.6	45	15.56	6	17,N
	1800	230/460	143T	K461	5K49UN4566	✓	\$1,173	E5	3.2/1.6	47	16.00	6	17,N
2	1800	230/460	145T	K2045	5KE49WN4571	✓	\$1,213	E5	5.6/2.8	44	18.00	10	17



### C-Face Footless

HP	RPM	VOLTS	FRAME	CAT. NO.	MODEL NO.	STOCK	LIST PRICE	MULT. SYMB.	F.L. AMPS	WEIGHT	"C" DIM.	BRAKE RATING (Lb/Ft)	FOOT NOTES
1/2	1800	230/460	56C	K457	5K49KN4563	✓	\$678	E5	1.8/0.9	31	14.06	3	N,17
3/4	1800	230/460	56C	K460	5K49PN4565	✓	\$797	E5	2.5/1.25	37	14.56	6	N,17
1	1800	230/460	143TC	K462	5K49UN4567	✓	\$1,192	E5	3.2/1.6	46	16.00	6	N,17
1 1/2	1800	208-230/460	56C	K1494	5K49RN4570	✓	\$1,050	E5	5.0/2.5	40	16.56	10	17
2	1800	230/460	145TC	K2046	5KE49WN4572	✓	\$1,103	E5	5.6/2.8	44	18.00	10	17

# Brake Motors, Three Phase

## C-Face Footed, C-Face Footed (Removable Base)

### Features:

- In addition to the Single Phase Features on previous page:
- Brake has manual wear adjustment up to 25 lb-ft. for longer pad life
- Stearns brakes, 56 series through 25 Lb-Ft, 87 series above 35 Lb-Ft and larger
- Brake leads routed through motor conduit box (TENV only)
- Universal mounting up to 15 Lb-Ft, C406 has verticle springs included, for larger brakes, see mod section
- CR<sup>200</sup> Corona resistant magnet wire (motor can be operated 10:1 variable torque and 2:1 constant torque)
- 1.15 Service Factor, 1.0 Service Factor where footnoted



BRAKE MOTORS

HP	RPM	VOLTS	FRAME	CAT. NO.	MODEL NO.	STOCK	LIST PRICE	MULT. SYMB.	F.L. AMPS	WEIGHT	"C" DIM.	BRAKE RATING (Lb/Ft)	FOOT NOTES
1/3	1800	208-230/460	56C	D450	056T17F5348	✓	\$603	E5	1.8-1.6/0.8	30	15.73	3	6
	1200	208-230/460	56C	D451	056T11F5325	✓	\$799	E5	1.9-2.2/1.1	30	15.73	3	6
1/2	1800	208-230/460	56C	D452	056T17F5349	✓	\$678	E5	2.3-2.4/1.2	32	16.23	3	6
	1200	208-230/460	56C	D453	056T11F5326	✓	\$997	E5	2.4-2.7/1.4	33	16.23	6	6
3/4	1800	208-230/460	56C	D454	056T17F5350	✓	\$797	E5	2.9-3.0/1.5	33	16.23	6	6
	1200	208-230/460	56C	D455	056T11F5327	✓	\$1,171	E5	3.1-3.2/1.6	37	16.73	6	6
1	1800	208-230/460	56C	D456	056T17F5357	✓	\$946	E5	3.5-3.6/1.8	35	16.73	6	6
	1200	208-230/460	145TC	C400	145TTFR5382	✓	\$1,255	E5	3.95-4.0/2.0	48	17.26	10	6
1 1/2	1800	208-230/460	56HC	D457	056T17F5358	✓	\$1,050	E5	4.8-4.8/2.4	38	17.26	10	6
	1800	208-230/460	145TC	C401	145TTFR5360	✓	\$1,050	E5	4.8-4.8/2.4	40	16.76	10	6
	1200	208-230/460	184TC	C402	184TTTL7084	✓	\$1,399	E5	5.55-5.2/2.6	130	19.23	15	AL,F,N,82
2	1800	208-230/460	145TC	C403	145TTFR5359	✓	\$1,103	E5	6.0-5.8/2.9	49	18.77	10	6
	1200	208-230/460	184TC	C404	184TTTL7083	✓	\$1,460	E5	6.8-6.6/3.3	90	19.23	15	AL,F,N,82
3	1800	230/460	182TC	C405	182TTTL7034	✓	\$1,460	E5	8.0/4.0	100	19.68	15	AL,F,N,82
5	1800	208-230/460	184TC	C406	184TTTL7041	✓	\$1,974	E5	13.8-12.4/6.2	115	20.68	25	AL,F,N,17,82
7 1/2	1800	230/460	213TC	C407	213TTTL7034	✓	\$2,592	E5	19.2/9.6	176	27.04	35	AL,N,17,82
	10	1800	230/460	215TC	C408	215TTTL7050	✓	\$3,240	E5	25.0/12.5	211	28.64	50

# Farm Duty / Agriculture, High Torque

## Single Phase, TEFC

### Features:

- Ball bearings, shaft end mechanically locked on C-face models (excludes 5K models)
- 1.15 Service Factor (except as noted)
- Capacitor start design for high starting torque
- Capacitor start/capacitor run design for higher efficiency, as noted
- Low temperature manual reset thermal protector
- Totally enclosed and fully gasketed construction for dirty environments
- Condensate drains
- Shaft slinger
- UL Recognized and CSA Certified



### Rigid Base

HP	RPM	VOLTS	FRAME	CAT. NO.	MODEL NO.	STOCK	LIST PRICE	MULT. SYMB.	F.L. AMPS	WEIGHT	"C" DIM.	FOOT NOTES
1/3	1800	115/208-230	56	F101	056C17F5324	✓	\$286	F1	6.6/3.1-3.3	24	11.82	
1/2	1800	115/208-230	56	F12E1	5KC46GN0050Y	✓	\$327	F1	9.0/4.5-4.5	21	11.83	d
	1800	115/208-230	56	F102	056C17F5325	✓	\$327	F1	8.8/4.2-4.4	25	11.82	
3/4	1800	115/208-230	56	F103	056C17F5326	✓	\$390	F1	11.0/5.4-5.5	29	12.32	
1	1800	115/208-230	143T	Z123	143TCFR5328	✓	\$452	S1	13.4/6.8-6.7	31	12.87	
	1800	115/230	56	F10E1	5KC49TN0063Y	✓	\$425	F1	13.2/6.6	37	12.96	d,17
	1800	115/208-230	56	F104	056C17F5327	✓	\$425	F1	13.4/6.8-6.7	31	12.82	
1 1/2	1800	115/208-230	145T	F15E1	5KCR48WN0292Y		\$532	S1	14.5/7.1-7.3	44	14.07	ES,1
	1800	115/208-230	145T	Z118	145TBFR5328	✓	\$532	S1	15.2/8.2-7.6	40	13.87	1
	1800	115/208-230	56H	F105	056B17F5307	✓	\$522	F1	15.2/8.2-7.6	41	13.82	ES,1
2	1800	115/230	145T	Z128	145TBFR5341	✓	\$591	S1	18.8/9.4	49	14.87	1
	1800	115/230	182T	Z119A	182TCFW7072	✓	\$644	S1	24.0/12.0	66	14.46	13
3	1800	230	184T	Z120A	184TBFW17045	✓	\$802	S1	14.2	92	14.96	1,13
5	1800	230	184T	Z121A	184TBFW7737	✓	\$976	S1	19.5	103	17.45	1,13
7 1/2	1800	230	215T	Z122	215TBFW7029	✓	\$1,448	S1	30.0	138	21.48	1

FARM DUTY / AGRICULTURAL

### C-Face Footed (Rigid Base)

HP	RPM	VOLTS	FRAME	CAT. NO.	MODEL NO.	STOCK	LIST PRICE	MULT. SYMB.	F.L. AMPS	WEIGHT	"C" DIM.	FOOT NOTES
1/3	1800	115/208-230	56C	F131	056C17F5358	✓	\$349	F1	6.6/3.1-3.3	23	11.82	
1/2	1800	115/208-230	56C	F132	056C17F5912	✓	\$390	F1	8.8/4.2-4.4	25	11.82	
3/4	1800	115/208-230	56C	F133	056C17F5913	✓	\$454	F1	11/5.4-5.5	29	12.32	
1	1800	115/208-230	56C	F134	056C17F5914	✓	\$488	F1	13.4/6.8-6.7	31	12.82	
1 1/2	1800	115/208-230	56HC	F135	056B17F5584	✓	\$586	F1	15.2/8.2-7.6	41	13.82	1,5
2	1800	115/230	56HC	K319	056B17F5319	✓	\$601	F1	18.8/9.4	50	14.82	1,5
3	1800	230	184TC	I314A	184TBFW7041	✓	\$901	S1	12.8	86	14.96	1,13
5	1800	230	184TC	I315A	184TBFW7034	✓	\$1,075	S1	19.5	101	17.45	1,13

# Farm Duty / Agriculture, Extra-High Torque Chore Motor®

## Single Phase, TEFC, Rigid Base

### Features:

- Class F insulation
- 1.15 Service Factor
- Ball bearings
- 300% and greater starting torque for hard-to-start applications
- Totally enclosed and fully gasketed for dirty environments
- 213/215TZ models have 1-1/8" shaft, 182TZ model has 7/8" shaft
- Manual reset thermal protector
- Condensate drains
- Shaft slinger
- UL Recognized and CSA Certified



HP	RPM	VOLTS	FRAME	CAT. NO.	MODEL NO.	STOCK	LIST PRICE	MULT. SYMB.	F.L. AMPS	WEIGHT	"C" DIM.	FOOT NOTES
2	1800	115/230	182TZ	Z112A	182TCFW9061	✓	\$682	S1	24.0/12.0	68	14.46	2,13
3	1800	230	184T	Z113A	184TCFW9057	✓	\$848	S1	19.0	90	16.46	2,13
5	1800	208-230	184T	Z114A	184TBFW7070	✓	\$1,034	S1	23.8/21.8	98	14.46	1,13
		230	213TZ	Z117	213TBFW7027	✓	\$1,150	S1	23.0	119	18.73	1
7 1/2	1800	230	215TZ	Z115	215TBFW7028	✓	\$1,535	S1	32.0	155	21.48	1
10	1800	230	215T	Z116	215TBFW7044	✓	\$1,911	S1	40.0	133	21.48	1,17

# Farm Duty / Agriculture, Auger Drive

## Single Phase, TEFC, N Flange

### Features:

- NEMA N flange mounting
- Manual reset thermal protector
- 48NZ: 1/2" dia. X 1.5" long shaft with flat
- 56NZ: 5/8" dia. X 2.06" long shaft with flat
- Extended (ODE) Shaft with flats for manual jogging
- F1201, F1202, F1203, F1204, and F1205 utilize a solid state electronic starting switch
- Ball bearings
- UL Recognized and CSA Certified



HP	RPM	VOLTS	FRAME	CAT. NO.	MODEL NO.	STOCK	LIST PRICE	MULT. SYMB.	F.L. AMPS	WEIGHT	"C" DIM.	FOOT NOTES
1/3	1800	115/230	48NY	HG646	5KH39QN9508Y	✓	\$307	F1	5.3/2.7	22	11.07	N,3,83
		115/208-230	56NY	C1291	5KC46GN0075U	✓	\$256	F1	5.8/2.8-2.9	21	12.00	
		115/230	48NZ	F1201	048C17F11005	✓	\$340	F1	6.2/3.1	22	10.31	E,2
1/2	1800/1500	115/208-230	56NY	C1292	5KC46JN0076U	✓	\$338	F1	8.4/4.0-4.2	23	12.00	2,49,50
		115/208-230	48NZ	F1202	048C17F11006	✓	\$370	F1	8.0/3.8-4.0	22	10.56	E,2
3/4	1800	115/208-230	56NY	C1293	5KCR49PN0077U	✓	\$399	F1	8.4/4.5-4.2	31	13.13	ES,1
		115/208-230	48NZ	F1203	048C17F11007	✓	\$431	F1	10.8/5.3-5.4	20	11.31	E,2
1	1800/1500	115/208-230	56NY	C1294	5KCR49UN0079U	✓	\$447	F1	10.8/6.0-5.4	40	14.51	ES,1,50,83
		115/230	56NZ	F1204	056C17F15537	✓	\$479	F1	13.4/6.7	36	13.38	E,2
1 1/2	1800	115/208-230	56NY	C1295	5KCR49WN0295U	✓	\$539	F1	14.5/7.1-7.3	44	14.51	ES,1,83
		115/230	56NZ	F1205	056B17F15516	✓	\$576	F1	15.2/7.6	45	14.38	d,E,1

# Grain Stirring, Single Phase

## TEFC, Rigid Base

### Applications:

Definite purpose for grain stirring systems inside grain bins.

### Features:

- 1.15 Service Factor
- Fully gasketed construction to keep grain dust out
- 7/8" diameter shaft
- Fan/Fan guard on shaft end keeps grain dust out of motor
- Durable powder coat paint
- Manual reset thermal protector
- Ball bearings
- UL Recognized and CSA Certified

HP	RPM	VOLTS	FRAME	CAT. NO.	MODEL NO.	STOCK	LIST PRICE	MULT. SYMB.	F.L. AMPS	WEIGHT	"C" DIM.	FOOT NOTES
1 1/2	1800	115/208-230	56HZ	X902	056B17F5324		\$457	F1	15.2/8.2-7.6	46	13.21	1,5

# Farm Duty, Capacitor Start

## TEAO, Rigid Base - High Efficiency

### Applications:

Designed for demanding agricultural belt drive fan applications such as poultry house fans and barn exhaust fans. **Catalog X912 is Totally Enclosed Air Over and must be mounted within the airstream for proper cooling.**

### Features:

- Capacitor start/capacitor run design
- Automatic reset thermal protector for higher efficiency
- Suitable for belted loads
- Fully gasketed
- Ball bearings
- UL Recognized and CSA Certified
- Continuous duty



FARM DUTY / AGRICULTURAL

HP	RPM	VOLTS	FRAME	CAT. NO.	MODEL NO.	STOCK	LIST PRICE	MULT. SYMB.	F.L. AMPS	WEIGHT	"C" DIM.	FOOT NOTES
1/2	1800	115/230	56	X913	056B17T20	✓	\$305	F1	4.6/2.3	22	10.47	1
	900	208-230	56Y	F781	5KCP49UN9838S	✓	\$312	F1	3.7-3.6	40	11.91	93
1	1800	115/230	56	X912	056B17T5303	✓	\$399	F1	9.2/4.6	32	11.44	1

# Farm Duty, PSC

## TEAO, Resilient Base - Thru Bolt - Variable Speed

### Applications:

Designed for demanding agricultural fan applications such as poultry houses and barn exhaust fans. Must be mounted within the airstream for proper cooling. Variable speed capabilities when used with a single phase speed control unit – NOT supplied by Marathon Motors. Super Variable speed motors, catalog X030, X031, and X032, are designed for lower temperature rise throughout a greater speed range.

### Features:

- Ball bearings
- Extended thru-bolts
- Fully gasketed
- 48/56 Frame mounting holes
- Continuous duty
- Automatic reset thermal protector
- 1/2" dia. x 2-1/2" long shaft with two flats, 90° apart
- UL Recognized and CSA Certified



HP	RPM	VOLTS	FRAME	CAT. NO.	MODEL NO.	STOCK	LIST PRICE	MULT. SYMB.	F.L. AMPS	WEIGHT	"C" DIM.	FOOT NOTES
1/4	1625	115/230	48YZ	X030	048A17T118	✓	\$218	F1	3.6/1.8	20	11.06	
	1625	115/230	48YZ	X024	048A17T2002	✓	\$178	F1	3.2/1.6	18	10.09	
	1075	115/230	48YZ	X027	048A11T2021	✓	\$194	F1	3.2/1.6	15	10.09	
1/3	1625	115/230	48YZ	X031	048A17T237	✓	\$241	F1	3.8/1.9	23	11.81	
	1625	115/230	48YZ	X025	048A17T2003	✓	\$198	F1	4.4/2.2	18	10.09	
	1075	115/230	48YZ	X028	048A11T2022	✓	\$210	F1	4.2/2.1	21	10.84	
1/2	1625	115/230	48YZ	X032	048A17T119	✓	\$266	F1	5.4/2.7	24	11.81	
	1625	115/230	48YZ	X026	048A17T2004	✓	\$215	F1	6.0/3.0	22	10.84	
	1075	115/230	48YZ	X029	048A11T2023	✓	\$225	F1	6.4/3.2	22	10.84	

# Farm Duty / Agricultural

## Single Phase, TEAO, Resilient Base-Thru Bolt

### Features:

- Split Phase and PSC, as noted
- Ball bearings
- Extended thru-bolts on X1903, X1904, P250, and P251
- 48Z Frame has 1/2" dia. x 2-1/2" long shaft with two flats
- 56Z Frame has 1/2" dia. x 1-7/8" long with 1-5/8" flat
- 48Y & 48YZ have 48/56 Fr. Mounting holes
- 1.0 Service Factor (except as noted)
- Thermal protection, as noted
- Fully Gasketed



FARM DUTY / AGRICULTURAL

HP	RPM	VOLTS	FRAME	OVER LOAD	CAT. NO.	MODEL NO.	STOCK	LIST PRICE	MULT. SYMB.	F.L. AMPS	WEIGHT	"C" DIM.	FOOT NOTES	
1/6	1800	115	48	AUTO	HG196	5KH32GN42S	✓	\$203	F1	3.5	13	8.94	3	
	1800	115	48	NONE	H195	5KH32GN42	✓	\$198	F1	3.5	13	8.94	3	
	1200	115	48	AUTO	H198	5KH35MN132S	✓	\$304	F1	3.7	17	9.57	3	
	1200	115	48	NONE	H197	5KH35MN132	✓	\$293	F1	3.7	17	9.57	3	
1/4	1800	115	48Z	AUTO	X1903	5KH32FNA499S	✓	\$158	F1	5.1	14	9.68	3,9	
	1800	115/208-230	48	AUTO	H649	5KHC39QN9575T	✓	\$329	F1	3.0/1.6-1.5	16	10.40	3	
	1800	115	48	AUTO	H135	5KH32FN3122S	✓	\$215	F1	5.1	15	8.94	3	
	1800	115/230	48Z	AUTO	P250	5KCP35KNNB057S	✓	\$209	F1	3.6/1.8	16	10.57	93	
	1800	115	48	NONE	H134	5KH32FN3122	✓	\$204	F1	5.1	15	8.94	3	
	1800	230	48	AUTO	H277	5KH33KN20S	✓	\$240	F1	2.3	15	9.19	3	
	1800/1200	115	48	NONE	H203	5KH36PN106	✓	\$250	F1	4.2/2.7	20	10.00	3	
	1200	115	56	AUTO	H137	5KH49MN6057S	✓	\$358	F1	5.6	22	10.48	3	
	1200	115	56	NONE	H136	5KH49MN6057	✓	\$348	F1	5.6	23	10.48	3	
	1/3	1800	115	48Z	AUTO	X1904	5KH33JNA500S	✓	\$178	F1	6.2	15	9.93	3,9
1800		115	48	AUTO	H139	5KH33JN3121S	✓	\$255	F1	6.2	18	9.19	3	
1800		115	48	NONE	HG138	5KH33JN3121	✓	\$244	F1	6.2	18	9.19	3	
1800		115/208-230	48	AUTO	HG648	5KHC39QN9581T	✓	\$356	F1	4.1/2.1-2.0	17	10.40	3	
1800		230	48	NONE	HG140	5KH36NNJ37	✓	\$256	F1	2.5	18	10.00	3	
1800		230	48	AUTO	HG141	5KH36NNJ37S	✓	\$261	F1	2.5	18	10.00	3	
1200		115/230	56	AUTO	HG699	5KH49PN6056S	✓	\$416	F1	7.0/3.5	26	11.48	3	
1200		115/230	56	NONE	HG142	5KH49PN6056	✓	\$404	F1	7.0/3.5	27	11.48	3	
1/2		1800	115/208-230	56	AUTO	H247	5KH42JN0328S	✓	\$242	F1	8.0/4.0-4.0	21	10.05	3
		1200	115/230	48Z	AUTO	P251	5KCP36NNB059S	✓	\$269	F1	7.2/3.6	18	11.0	93
	1800	115/208-230	56	NONE	H276	5KH42JN0328	✓	\$342	F1	8.0/4.0-4.0	21	10.05	3	
	1800	115/208-230	56	AUTO	H647	5KHC39QN9584X	✓	\$377	F1	5.2/2.7-2.6	19	10.05	3	
	1800	115	56	NONE	HG143	5KH42GN0337	✓	\$325	F1	8.0	21	10.05	3,19	
3/4	1800	115/208-230	56	AUTO	C1314	5KCR49PN0492S	✓	\$313	F1	7.0/3.8-3.5	30	11.38	2,50,55,111	
	1800	115/208-230	56	AUTO	C1303	5KCR46NN0264T	✓	\$400	F1	8.2/4.0-4.1	28	10.78	2,19	
1	1800	115/208-230	56	AUTO	C1315	5KCR49SN0493S	✓	\$367	F1	10.6/5.5-5.3	34	11.85	2,111	
	1800	115/208-230	56	AUTO	C1302	5KCR49SN0042S	✓	\$419	F1	9.6/5.2-4.8	35	11.91	2,50,55,111	
1 1/2	1800	115/208-230	56	AUTO	C1909	5KCR49ZN0785S	✓	\$431	F1	14.0/7.2-7.0	49	13.96	2,50,55,111	



# Crop Dryer, Single Phase

## Dripproof/Air Over, Rigid Base

### Applications:

Crop dryers with air over/fan on shaft designs.

### Features:

- Double sealed ball bearings
- Continuous duty
- Class F insulation system
- Thermostats for thermal overload protection (auto reset protector on Z304)
- 34" long leads for ease of installation
- Keyed shafts with 1/4"-20 UNC tapped hole in end
- Capacitors included, shipped loose on catalog Z307 and Z308, mounted on all other models
- Extra nameplate included, loose, for remote mounting



HP	RPM	VOLTS	FRAME	OVER LOAD	CAT. NO.	MODEL NO.	STOCK	LIST PRICE	MULT. SYMB.	F.L. AMPS	WEIGHT	"C" DIM.	FOOT NOTES
3-4.5	3600	230	145TZ	AUTO	Z304	145TBDR5309	✓	\$611	S1	13.0-19.0	43	13.74	1
3-5	3600	230	182TZ	TSTAT	Z309	182TCDR7013		\$734	S1	15.8-25.3	67	15.00	2
5-7.5	3600	230	184TZ	TSTAT	Z305A	184TCDW7615	✓	\$894	S1	27.2-35.0	98	15.88	2,13
7-10	3600	230	184TZ	TSTAT	Z307A	184TBDW7009	✓	\$1,126	S1	31.0-42.0	95	15.88	1,13
7.5-10	3600	230	184TZ	TSTAT	Z313	184TBDR7324		\$1,126	S1	30.0-42.0	89	16.43	1,13
7.5-10.5	3600	230	215TZ	TSTAT	Z314	215TCDW7012		\$1,316	S1	37.0-49.5	139	19.16	2,F
7-9	3600	230	184TZ	TSTAT	Z306A	184TCDW7617	✓	\$1,009	S1	36.5-46.0	83	14.88	2,13
10-15	3600	230	215TZ	TSTAT	Z315	215TBDW7013		\$1,515	S1	39.5-61.5	159	20.42	1,F

FARM DUTY / AGRICULTURAL

# Crop Dryer, Three Phase

## Dripproof/Air Over, Rigid Base

### Applications:

Crop dryers with air over/fan on shaft designs where three phase power is available.

### Features:

- Ball bearings
- Thermostats for thermal overload protection
- 34" long leads exit elbow connector in bracket
- Keyed shafts with 1/4"-20 UNC tapped hole in end
- Extra nameplate included, loose, for remote mounting
- Continuous duty
- Class F insulation

HP	RPM	VOLTS	FRAME	CAT. NO.	MODEL NO.	STOCK	LIST PRICE	MULT. SYMB.	F.L. AMPS @ LOW SPEED	WEIGHT	"C" DIM.	FOOT NOTES
5-7	3600	208-220/440	184TZ	Y302A	184TTDW7611	✓	\$749	E6	13.8-13.2/6.6	71	13.16	13
7-10	3600	208-220/440	184TZ	Y303	184TTDR7612	✓	\$794	E6	28.0-27.0/13.5	69	14.22	d
	3600	208-220/440	184TZ	Y1303	184TTDW7612	✓	\$794	E6	20.0-19.2/9.6	69	16.19	13
10-15	3600	208-220/440	215TZ	Y304	215TTDW7301	✓	\$1,048	E6	28-26.1/13.1	95	17.41	2,13

# Farm Duty / Agricultural

## Single Phase, TEAO, Direct Drive-Thru Bolt

### Features:

- Economical split phase design
- X909 has 1/2" diameter x 1.5" long shaft with flat
- X910 and X911 have 1/2" dia. X 2-1/2" long shaft with two flats, 90 degrees apart
- Thermal protection, as noted
- Ball bearings
- Fully gasketed



### Single Speed

HP	RPM	VOLTS	FRAME	OVER LOAD	CAT. NO.	MODEL NO.	STOCK	LIST PRICE	MULT. SYMB.	F.L. AMPS	WEIGHT	"C" DIM.	FOOT NOTES
1/4	1800	115	48Y	MANUAL	X909	048S17T2004	✓	\$156	F1	4.0	10	7.62	3,59
1/2	900	208-230	56Y	AUTO	F780	5KCP49UN9837S	✓	\$305	F1	3.7-3.6	40	11.91	93

### Two Speed

HP	RPM	VOLTS	FRAME	OVER LOAD	CAT. NO.	MODEL NO.	STOCK	LIST PRICE	MULT. SYMB.	F.L. AMPS	WEIGHT	"C" DIM.	FOOT NOTES
1/4	1800/1200	115	48YZ	AUTO	X910	048S17T366	✓	\$202	F1	4.1/2.5	17	11.09	3,59
1/3	1800/1200	115	48YZ	AUTO	X911	048S17T365	✓	\$254	F1	5.3/2.9	18	11.34	3,59



## Incubator/Hatchery Vent Fan

### Single Phase (PSC), TEAO, Thru-Bolt

HP	RPM	VOLTS	FRAME	CAT. NO.	MODEL NO.	STOCK	LIST PRICE	MULT. SYMB.	F.L. AMPS	WEIGHT	"C" DIM.	FOOT NOTES
1/3	1800	115/230	48Z	P239	5KCP33GNA471S	✓	\$352	F1	4.0/2.0	15	10.18	d



## Center Pivot Irrigation

### Three Phase, TEFC, C-Face footless

HP	RPM	VOLTS	FRAME	CAT. NO.	MODEL NO.	STOCK	LIST PRICE	MULT. SYMB.	F.L. AMPS	WEIGHT	"C" DIM.	FOOT NOTES
1	1800/1500	460/380	56C	K1476	5K49JN4051T	✓	\$386	F1	2.0/2.1	23	12.08	50
1 1/2	1800/1500	460/380	56C	K1438	5K49NN4052T	✓	\$436	F1	2.4/2.7	29	12.08	50

# PowerWash™ XT Washdown Duty, Single Phase

## White Epoxy, Totally Enclosed

### Features:

- Encapsulated electronic starting switch is impervious to moisture
- Capacitor start induction run design for high starting torque unless otherwise noted
- Class F insulation
- 1.15 Service Factor
- Double sealed ball bearings
- 303 Stainless steel shaft with spring loaded contact seals in each endshield
- Stainless steel conduit box cover, nameplate, fan guard (TEFC) and hardware
- Cast oversized conduit box with high temperature Nitrile gaskets and threaded entrance
- Plugged drain holes in each endshield for all angle mounting
- Internal corrosion resistant coatings on frame, base, endshields, rotor and stator
- USDA-approved, white epoxy RUST-OLEUM® paint
- UL Recognized, CSA Certified and CE Mark



**IP55**

### Rigid Base

HP	RPM	VOLTS	FRAME	CAT. NO.	MODEL NO.	STOCK	LIST PRICE	MULT. SYMB.	F.L. AMPS	WEIGHT	"C" DIM.	FOOT NOTES
1/2	1800	115/208-230	56	N680	056C17W5336	✓	\$512	F3	8.8/4.4-4.4	30	10.81	
3/4	1800	115/208-230	56	N681	056C17W5337	✓	\$601	F3	10.8/5.4-5.4	25	11.31	
1	1800	115/208-230	56	N682	056C17W5338	✓	\$688	F3	12.8/6.4-6.4	34	11.81	
	1800	115/208-230	143T	N685	143TCWR17031	✓	\$648	F3	12.8/6.4-6.4	78	12.43	
1 1/2	1800	115/208-230	145T	N683	145TCWR5326	✓	\$876	F3	19.0/9.5-9.5	50	13.75	
2	1800	115/208-230	182T	N684	182TCWR7026	✓	\$1,273	F3	25.2/12.6-2.6	60	13.46	

### C-Face Footless

HP	RPM	VOLTS	FRAME	CAT. NO.	MODEL NO.	STOCK	LIST PRICE	MULT. SYMB.	F.L. AMPS	WEIGHT	"C" DIM.	FOOT NOTES
1/3	3600	115/208-230	56C	N530	056C34W5301	✓	\$420	F3	5.2/2.8-2.6	28	10.69	
	1800	115/208-230	56C	N531	056C17W5326	✓	\$456	F3	6.4/3.2-3.2	23	10.69	
1/2	3600	115/208-230	56C	N532	056C34W5302	✓	\$456	F3	7.6/4.0-3.8	27	10.69	
	1800	115/208-230	56C	N523	056C17W5327	✓	\$468	F3	8.8/4.4-4.4	26	11.19	
3/4	3600	115/208-230	56C	N524	056C34W5303	✓	\$459	F3	10.0/5.2-5.0	30	11.69	
	1800	115/208-230	56C	N525	056C17W5328	✓	\$541	F3	10.8/5.4-5.4	31	11.69	
1	3600	115/208-230	56C	N526	056C34W5304	✓	\$461	F3	12.0/6.2-6.0	32	12.19	
	1800	115/208-230	56C	N527	056C17W5329	✓	\$613	F3	12.8/6.4-6.4	33	12.19	
1 1/2	3600	115/208-230	56C	N528	056C34W5305	✓	\$680	F3	17.0/8.5-8.5	50	12.69	
	1800	115/208-230	56C	N529	056C17W5330	✓	\$785	F3	19.0/9.5-9.5	23	13.69	

### C-Face Footed (Rigid Base)

HP	RPM	VOLTS	FRAME	CAT. NO.	MODEL NO.	STOCK	LIST PRICE	MULT. SYMB.	F.L. AMPS	WEIGHT	"C" DIM.	FOOT NOTES
1/3	3600	115/208-230	56C	N556	056C34W5306	✓	\$423	F3	5.2/2.7-2.6	50	10.41	
	1800	115/208-230	56C	N557	056C17W5331	✓	\$459	F3	6.4/3.2-3.2	25	10.69	
1/2	3600	115/208-230	56C	N558	056C34W5307	✓	\$459	F3	7.6/4.0-3.8	26	10.69	
	1800	115/208-230	56C	N559	056C17W5332	✓	\$474	F3	8.8/4.4-4.4	27	11.19	
3/4	3600	115/208-230	56C	N540	056C34W5308	✓	\$463	F3	10.0/5.2-5.0	31	11.69	
	1800	115/208-230	56C	N541	056C17W5333	✓	\$538	F3	10.8/5.4-5.4	31	11.69	
1	3600	115/208-230	56C	N542	056C34W5309	✓	\$465	F3	12.0/6.2-6.0	33	12.19	
	1800	115/208-230	56C	N543	056C17W5334	✓	\$618	F3	12.8/6.4-6.4	34	12.19	
1 1/2	3600	115/208-230	56C	N544	056C34W5310	✓	\$682	F3	17.0/8.5-8.5	36	12.69	
	1800	115/208-230	56HC	N545	056C17W5335	✓	\$789	F3	19.0/9.5-9.5	43	13.69	5
2	3600	115/208-230	56HC	N546	056C34W99003	✓	\$823	F3	20.0/11.4-10.0	55	12.87	5

WASHDOWN - Painted and Stainless Steel

# PowerWash™ XT Washdown Duty, Three Phase

## White Epoxy, Totally Enclosed

### Features:

- 10:1 Variable torque, Constant torque speed range as listed below
- MAX GUARD® Class F insulation system
- 1.15 Service Factor on sinewave, 1.0 Service Factor on IGBT power
- Double sealed ball bearings
- 303 Stainless steel shaft with spring loaded contact seals in each endshield (Drive end only on TENV motors)
- Stainless steel conduit box cover, nameplate, fan guard (TEFC only) and hardware
- Cast oversized conduit box with high temperature nitrile gaskets and threaded entrance
- Plugged drain holes in each endshield for all angle mounting
- Internal corrosion resistant coatings on frame, base, endshields, rotor and stator
- USDA-approved, white epoxy RUST-OLEUM® paint
- UL Recognized, CSA Certified and CE Mark



### Rigid Base

HP	RPM	VOLTS	FRAME	CAT. NO.	MODEL NO.	STOCK	CT SPEED RANGE*	LIST PRICE	MULT. SYMB.	NOM. EFF.	F.L. AMPS	WEIGHT	"C" DIM.	FOOT NOTES
1/3	1800	208-230/460	56	E286	5KS49HN4595	✓	10:1	\$450	F3	75.5	1.2-1.6/8	24	9.68	ES,N,20,50
1/2	1800	208-230/460	56	N322	056T17W5344	✓	10:1	\$462	F3	74.0	2.0-2.0/1.0	25	10.81	V
3/4	1800	208-230/460	56	N320	056T17W5340	✓	10:1	\$492	F3	77.0	2.8-2.8/1.4	25	10.81	V
1	1800	208-230/460	56	N309	056T17V5346	✓	1000:1	\$517	F3	80.0	3.2-3.2/1.6	35	11.18	N
	1800	208-230/460	143T	N310	143TTVR5329	✓	1000:1	\$564	F3	82.5	3.2-3.2/1.6	35	11.62	N
	1200	208-230/460	145T	<b>N323</b>	145TTWR6076	✓	10:1	\$884	F3	82.5	3.6-4.2/2.1	45	13.25	V
1 1/2	1800	208-230/460	145T	<b>N321A</b>	145TTWR6029	✓	10:1	\$659	F3	86.5	5.2-4.4/2.2	51	12.75	V
2	1800	208-230/460	145T	<b>N312A</b>	145TTWR6027	✓	10:1	\$819	F3	86.5	6.0-5.6/2.8	46	13.75	V
	3600	208-230/460	145T	N324	145TTWR16002	*	10:1	\$997	F3	86.5	8.8-8.0/4.0	52	13.68	V
	1800	208-230/460	56HZ	N313	056T17W5328	✓	10:1	\$707	F3	82.5	8.6-8.6/4.3	49	14.25	V,Z,5,17
3	1800	208-230/460	182T	<b>N314B</b>	182TTWW6027	✓	10:1	\$1,083	F3	89.5	8.2-8.2/4.1	69	13.96	V,13
	3600	208-230/460	184T	<b>N315A</b>	184TTWW6004	✓	10:1	\$1,363	F3	88.5	13.2-12.0/6.0	75	14.46	V,13
	1800	208-230/460	184T	<b>N316B</b>	184TTWW6027	✓	10:1	\$1,238	F3	89.5	13.0-13.0/6.5	85	14.96	V,13
7 1/2	3600	208-230/460	184T	<b>N317A</b>	184TTWW6003	✓	10:1	\$1,720	F3	89.5	17.6-16.8/8.4	87	15.96	V,13
	3600	208-230/460	213T	<b>N325</b>	213TTWW16002	*	10:1	\$1,920	F3	89.5	19.2-17.6/8.8	87	16.59	V,68
	1800	208-230/460	213T	<b>N318A</b>	213TTWR6027	✓	10:1	\$1,545	F3	91.7	20.4-20.4/10.2	131	17.21	V
10	1800	208-230/460	215T	<b>N319A</b>	215TTWR6027	✓	10:1	\$1,849	F3	91.7	26.0-26.0/13.0	165	18.71	V

Catalog numbers (Cat No.) highlighted in bold blue have efficiency levels that meet EISA requirements

\* Requires nameplate modification

WASHDOWN - Painted and Stainless Steel

# PowerWash™ XT Washdown Duty, Three Phase

## White Epoxy, Totally Enclosed



### C-Face Footless

Same features as shown on page 106

HP	RPM	VOLTS	FRAME	CAT. NO.	MODEL NO.	STOCK	CT SPEED RANGE*	LIST PRICE	MULT. SYMB.	NOM. EFF.	F.L. AMPS	WEIGHT	"C" DIM.	FOOT NOTES
1/4	1800	208-230/460	56C	N640	056T17V5326	✓	1000:1	\$436	F3	68.0	1.1-1.1/55	21	9.56	N
1/3	3600	208-230/460	56C	N665	056T34V99001	✓	1000:1	\$380	F3	77.0	1.1-1.1/55	19	10.06	N
	1800	208-230/460	56C	N641	056T17V5327	✓	1000:1	\$463	F3	72.0	1.3-1.3/65	21	9.56	N
1/2	1800	208-230/460	56C	N666	056T17W99003	✓	10:1	\$463	F3	68.0	1.7-1.7/85	21	10.69	V
	3600	208-230/460	56C	N667	056T34V99002	✓	1000:1	\$447	F3	82.5	1.7-1.6/80	22	10.06	N
	1800	208-230/460	56C	N642	056T17V5328	✓	1000:1	\$478	F3	78.5	1.8-1.8/9	25	10.06	N
3/4	1800	208-230/460	56C	N668	056T17W99006	✓	10:1	\$478	F3	74.0	2.7-2.8/14	25	11.19	V
	3600	208-230/460	56C	N643	056T34V5301	✓	1000:1	\$482	F3	84.0	2.6-2.4/1.2	50	11.06	N
	1800	208-230/460	56C	N644	056T17V5329	✓	1000:1	\$553	F3	80.0	2.5-2.5/1.25	30	10.56	N
1	1800	208-230/460	56C	N669	056T17W99002	✓	10:1	\$553	F3	77.0	2.7-2.8/1.4	28	11.69	V
	3600	208-230/460	56C	N645	056T34V5302	✓	1000:1	\$563	F3	78.5	2.8-2.6/1.3	34	11.56	N
	1800	208-230/460	56C	N646	056T17V5330	✓	1000:1	\$576	F3	80.0	3.2-3.2/1.6	34	11.56	N
1 1/2	1800	208-230/460	143TC	N647	143TTVR5326	✓	1000:1	\$576	F3	80.0	3.2-3.2/1.6	35	11.75	N
	3600	208-230/460	56C	N648	056T34V5303	✓	1000:1	\$597	F3	80.0	4.2-3.8/1.9	42	12.56	N
	1800	208-230/460	56C	K2068	5KE49TN4592	✓	10:1	\$591	F3	84.0	4.4-5.3/2.65	40	13.19	d,50
	1800	208-230/460	56C	N649	056T17V5331	✓	1000:1	\$601	F3	84.0	4.2-4.2/2.1	46	13.06	N
	1800	208-230/460	143TC	N650	143TTVR5327	✓	1000:1	\$601	F3	84.0	4.2-4.2/2.1	47	13.25	N
2	1800	208-230/460	145TC	<b>K2055</b>	5KE49TN8378	✓	10:1	\$605	F3	84.0	4.4-5.3/2.65	39	13.25	d,50
	3600	208-230/460	56C	N651	056T34V5304	✓	1000:1	\$683	F3	82.5	5.6-5.0/2.5	48	13.06	N
	3600	208-230/460	145TC	N652	145TTVR5301	✓	1000:1	\$683	F3	82.5	5.6-5.0/2.5	42	13.25	N
	1800	208-230/460	56C	N653	056T17W5326	✓	10:1	\$700	F3	81.5	6.2-6.2/3.1	38	12.69	V
	1800	208-230/460	56C	K2066	5KE48WN4593	✓	10:1	\$637	F3	84.0	6.0-5.6/2.8	44	13.69	d,50
	1800	208-230/460	145TC	<b>K2056</b>	5KE48WN8364	✓	10:1	\$651	F3	84.0	6.0-5.6/2.8	45	13.75	d,50
3	1800	208-230/460	145TC	<b>N654A</b>	145TTWR4326	✓	10:1	\$675	F3	84.0	6.0-5.6/2.8	47	13.75	V
	3600	208-230/460	56C	N662	056T34W99001	✓	10:1	\$1,103	F3	84.0	8.4-7.6/3.8	39	13.19	V
	3600	208-230/460	145TC	N655	145TTWR5301	✓	10:1	\$839	F3	80.0	8.4-7.6/3.8	36	13.25	d,V
	3600	208-230/460	145TC	<b>N655A</b>	145TTWR4301	✓	10:1	\$897	F3	85.5	8.4-7.6/3.8	48	13.75	V
5	1800	208-230/460	182TC	<b>N656B</b>	182TTWW4028	✓	10:1	\$987	F3	87.5	8.4-7.6/3.8	81	14.47	V,13
	3600	208-230/460	184TC	<b>N657B</b>	184TTWW4002	✓	10:1	\$1,251	F3	87.5	13.2-12.0/6.0	75	14.47	V,13
	1800	208-230/460	184TC	<b>N658B</b>	184TTWW4028	✓	10:1	\$1,118	F3	87.5	13.0-13.0/6.5	95	14.97	V,13
7 1/2	3600	208-230/460	213TC	<b>N659A</b>	213TTWR4001	✓	10:1	\$1,551	F3	88.5	17.6-16.8/8.4	102	17.47	V
	1800	208-230/460	213TC	<b>N660</b>	213TTWR7026	✓	10:1	\$1,328	F3	89.5	24.0-22.0/11.0	125	17.71	V
10	3600	208-230/460	215TC	<b>N663</b>		✓	10:1	\$1,783	F3	89.5	23.6/11.8	170	20.57	V
	1800	208-230/460	215TC	<b>N661</b>	215TTWR7026	✓	10:1	\$1,507	F3	89.5	29.0-28.0/14.0	150	18.71	V
15	3600	208-230/460	215TC	<b>N664</b>	215TTWW14008	✓	10:1	\$2,050	F3	90.2	36.0/18.0	140	20.57	V

WASHDOWN - Painted and Stainless Steel

Catalog numbers (Cat No.) highlighted in bold blue have efficiency levels that meet EISA requirements

\* Requires nameplate modification

# PowerWash™ XT Washdown Duty, Three Phase

## White Epoxy, Totally Enclosed



### C-Face Footed (Rigid Base)

Same features as shown on page 106

HP	RPM	VOLTS	FRAME	CAT. NO.	MODEL NO.	STOCK	CT SPEED RANGE*	LIST PRICE	MULT. SYMB.	NOM. EFF.	F.L. AMPS	WEIGHT	"C" DIM.	FOOT NOTES
1/4	1800	208-230/460	56C	N564	056T17V5332	✓	1000:1	\$438	F3	68.0	1.1-1.1/55	24	10.08	N
	1800	575	56C	N620A	056T17V15501	✓	1000:1	\$438	F3	68.0	0.44	23	10.06	N
1/3	3600	208-230/460	56C	N631	056T34W99002	✓	10:1	\$372	F3	77.0	1.1-1.1/55	22	10.08	V
	1800	208-230/460	56C	N628	056T17W5334	✓	10:1	\$481	F3	68.0	1.7-1.7/85	23	10.69	V
	1800	575	56C	N621	056T17W5335	✓	10:1	\$481	F3	68.0	0.68	20	10.69	V
1/2	3600	208-230/460	56C	N566	056T34V5305	✓	1000:1	\$437	F3	76.0	1.7-1.6/8	27	10.58	N
	1800	208-230/460	56C	N567	056T17V5336	✓	1000:1	\$490	F3	78.5	1.8-1.8/9	26	10.06	N
	1800	208-230/460	56C	N632	056T17W99005	✓	10:1	\$490	F3	74.0	1.9-2.0/1.0	22	11.19	V
	1800	575	56C	N622	056T17V5337	✓	1000:1	\$490	F3	78.5	0.8	25	10.08	N
	1200	208-230/460	56C	N568	056T11V5376	✓	1000:1	\$611	F3	77.0	2.3-2.3/1.15	23	11.56	N
	3/4	3600	208-230/460	56C	N569	056T34V5306	✓	1000:1	\$480	F3	75.5	2.6-2.4/1.2	50	11.08
1	1800	208-230/460	56C	N599	056T17V5338	✓	1000:1	\$567	F3	80.0	2.5-2.5/1.25	31	10.56	N
	1800	208-230/460	56C	N633	056T17W99004	✓	10:1	\$567	F3	77.0	2.9-2.8/1.4	26	11.19	V
	1800	575	56C	N623	056T17W5339	✓	10:1	\$567	F3	77.0	1.1	31	11.19	V
	1200	208-230/460	56C	N600	056T11V5377	✓	1000:1	\$665	F3	78.5	3.0-3.0/1.5	25	13.06	N,5
	3600	208-230/460	56C	N601	056T34V5307	✓	1000:1	\$561	F3	78.5	2.8-2.6/1.3	35	11.56	N
	1800	208-230/460	56C	N602	056T17V5340	✓	1000:1	\$591	F3	80.0	3.2-3.2/1.6	35	11.58	N
1 1/2	1800	575	56C	EG311	5KS49UN4598	✓	10:1	\$591	F3	82.5	1.2	39	12.08	d
	1800	575	56C	N627	056T17W5341	✓	10:1	\$591	F3	77.0	1.5	29	11.69	V
	1800	208-230/460	143TC	<b>N626A</b>	143TTWR6028	✓	10:1	\$691	F3	85.5	3.2-3.1/1.55	35	12.75	V
	1200	208-230/460	56HC	N604	056T11W5377	✓	10:1	\$713	F3	78.5	4.0-4.0/2.0	36	13.06	5,V
	3600	208-230/460	56C	N605	056T34V5308	✓	1000:1	\$620	F3	80.0	4.2-3.8/1.9	43	12.56	N
	1800	208-230/460	56C	K2067	5KE49TN4597	✓	10:1	\$617	F3	84.0	5.3-4.4/2.2	40	13.19	d
	1800	208-230/460	56C	N606	056T17V5342	✓	1000:1	\$617	F3	84.0	4.2-4.2/2.1	47	13.06	N
	1800	208-230/460	145TC	N607	145TTVR5326	✓	1000:1	\$617	F3	84.0	4.2-4.2/2.1	48	13.12	N
	1800	575	145TC	N629	145TTVR5030	✓	1000:1	\$617	F3	84.0	1.8	42	13.12	N
	1200	208-230/460	56HC	N608	056T11W5378	✓	10:1	\$753	F3	77.0	5.7-5.7/2.85	50	14.18	5,V
2	3600	208-230/460	56HC	N609	056T34V5309	✓	1000:1	\$688	F3	82.5	5.6-5.0/2.5	49	13.06	N,5,17
	3600	208-230/460	145TC	N610	145TTVR5302	✓	1000:1	\$763	F3	84.0	5.6-5.0/2.5	49	13.12	N
	1800	208-230/460	56C	N611	056T17W5327	✓	10:1	\$708	F3	81.5	6.2-6.2/3.1	38	12.69	V
	1800	575	145TC	<b>N630</b>	145TTWR6033	✓	10:1	\$852	F3	86.5	2.3	46	13.75	V
	1800	208-230/460	145TC	<b>N612A</b>	145TTWR6026	✓	10:1	\$852	F3	86.5	6.0-5.6/2.8	46	13.75	V
3	3600	208-230/460	145TC	<b>N613A</b>	145TTWR6001	✓	10:1	\$1,126	F3	89.5	8.4-7.6/3.8	46	13.75	V
	3600	208-230/460	182TC	<b>N634</b>	182TTWW16002	✓	10:1	\$1,337	F3	86.5	8.2-7.6/3.8	80	14.97	V,13
	1800	208-230/460	182TC	N1614	182TTWW4026	✓	10:1	\$1,009	F3	87.5	8.2-8.2/4.1	65	14.47	d,V
	1800	208-230/460	182TC	<b>N614B</b>	182TTWW6026	✓	10:1	\$1,255	F3	89.5	8.6-7.8/3.9	80	14.47	V
5	3600	208-230/460	184TC	<b>N615B</b>	184TTWW6001	✓	10:1	\$1,570	F3	88.5	13.2-12.0/6.0	79	14.47	V
	1800	208-230/460	184TC	<b>N616B</b>	184TTWW6026	✓	10:1	\$1,417	F3	88.5	13.6-12.8/6.4	84	14.97	V
7 1/2	3600	208-230/460	213TC	<b>N617A</b>	213TTWR6002	✓	10:1	\$1,950	F3	89.5	18.6-17.8/8.9	140	17.47	V
	3600	208-230/460	184TC	<b>N635</b>	184TTWW16002	✓	10:1	\$1,805	F3	89.5	19.2-17.6/8.8	94	15.97	V,13
	1800	208-230/460	213TC	<b>N618A</b>	213TTWR6026	✓	10:1	\$1,797	F3	91.7	23.4-21.4/10.7	135	17.71	V
10	3600	208-230/460	215TC	<b>N637</b>	215TTWW16003	✓	10:1	\$2,240	F3	90.2	24.5-23.6/11.8	129	20.57	V
	1800	208-230/460	215TC	<b>N619A</b>	215TTWR6026	✓	10:1	\$2,043	F3	91.7	27.6-26.6/13.3	145	18.71	V

Catalog numbers (Cat No.) highlighted in bold blue have efficiency levels that meet EISA requirements

\* Requires nameplate modification

# PowerWash™ XT Washdown Duty, Three Phase

White Epoxy, Totally Enclosed

Close Coupled Pump, JM, Rigid Base

Same features as shown on page 106

HP	RPM	VOLTS	FRAME	CAT. NO.	MODEL NO.	STOCK	CT SPEED RANGE*	LIST PRICE	MULT. SYMB.	NOM. EFF.	F.L. AMPS	WEIGHT	"C" DIM.	FOOT NOTES
1	1800	208-230/460	143JM	<b>N201</b>	143TTWR14032	✓	10:1	\$750	F3	82.5	3.2-3.1/1.55	41	16.25	
1 1/2	3600	208-230/460	143JM	<b>N202</b>	143TTWR14002	✓	10:1	\$774	F3	82.5	4.4-4.0/2.0	33	16.25	
	1800	208-230/460	145JM	<b>N203</b>	143TTWR14031	✓	10:1	\$792	F3	84.0	4.5-4.4/2.2	47	16.25	
2	3600	208-230/460	145JM	<b>N204</b>	145TTWR14003	✓	10:1	\$806	F3	84.0	5.6-5.2/2.6	50	16.25	
	1800	208-230/460	145JM	<b>N205</b>	145TTWR14031	✓	10:1	\$824	F3	84.0	6.0-5.6/2.8	49	16.75	
3	3600	208-230/460	145JM	<b>N206</b>	145TTWR14004	✓	10:1	\$837	F3	85.5	8.4-7.6/3.8	54	16.75	
	1800	208-230/460	182JM	<b>N207</b>	182TTWR14031	✓	10:1	\$1,373	F3	87.5	8.0-8.6/4.3	79	16.75	13
5	3600	208-230/460	184JM	<b>N208</b>	184TTWW14005	✓	10:1	\$1,503	F3	87.5	13.0-12.0/6.0	81	16.75	13
	1800	208-230/460	184JM	<b>N209</b>	184TTWW14031	✓	10:1	\$1,427	F3	87.5	14.0-13.0/6.5	995	17.63	13
7 1/2	3600	208-230/460	184JM	<b>N210</b>	184TTWW14004	✓	10:1	\$1,400	F3	88.5	17.6-16.8/8.4	110	18.25	13
	1800	208-230/460	213JM	<b>N211</b>	213TTWW14031	✓	10:1	\$2,412	F3	89.5	24.0-22.0/11.0	135	19.50	
10	3600	208-230/460	215JM	<b>N212</b>	215TTWW14009	✓	10:1	\$2,345	F3	89.5	27.0-24.0/12.0	142	22.20	
	1800	208-230/460	215JM	<b>N213</b>	215TTWW14031	✓	10:1	\$2,302	F3	89.5	29.0-28.0/14.0	150	21.70	
15	3600	208-230/460	215JM	<b>N214</b>	215TTWW14007	✓	10:1	\$2,716	F3	90.2	37.0-36.0/18.0	160	22.20	

## Centrifugal Pump (Jet Pump), C-Face Footless, 56J

HP	RPM	VOLTS	FRAME	CAT. NO.	MODEL NO.	STOCK	CT SPEED RANGE*	LIST PRICE	MULT. SYMB.	NOM. EFF.	F.L. AMPS	WEIGHT	"C" DIM.	FOOT NOTES
3/4	3600	208-230/460	56J	N220	056T34W99003	✓	10:1	\$554	F3	75.5	2.5-2.4/1.2	24	10.81	
1	3600	208-230/460	56J	N222	056T34W99004	✓	10:1	\$599	F3	77.0	3.4-3.2/1.6	36	10.81	
1 1/2	3600	208-230/460	56J	N224	056T34W99005	✓	10:1	\$632	F3	81.5	4.4-4.2/2.1	43	11.81	
2	3600	208-230/460	56J	N226	056T34W99006	✓	10:1	\$689	F3	82.5	5.8-5.6/2.8	48	12.31	
3	3600	208-230/460	56J	N228	056T34W99009	✓	10:1	\$735	F3	84.0	8.4-7.6/3.8	50	13.25	

## Centrifugal Pump (Jet Pump), C-Face Footed (Rigid Base), 56J

HP	RPM	VOLTS	FRAME	CAT. NO.	MODEL NO.	STOCK	CT SPEED RANGE*	LIST PRICE	MULT. SYMB.	NOM. EFF.	F.L. AMPS	WEIGHT	"C" DIM.	FOOT NOTES
3/4	3600	208-230/460	56J	N230	056T34W99007	✓	10:1	\$523	F3	75.5	2.5-2.4/1.2	23	10.81	
1	3600	208-230/460	56J	N232	056T34W99010	✓	10:1	\$574	F3	77.0	3.4-3.2/1.6	35	10.81	
1 1/2	3600	208-230/460	56J	N234	056T34W99011	✓	10:1	\$619	F3	81.5	4.4-4.2/2.1	42	11.81	
2	3600	208-230/460	56J	N236	056T34W99008	✓	10:1	\$662	F3	82.5	5.8-5.6/2.8	47	12.31	
3	3600	208-230/460	56J	N238	056T34W99012	✓	10:1	\$714	F3	84.0	8.4-7.6/3.8	49	13.25	

## Brakemotor C-Face Footed (Rigid Base)

HP	RPM	VOLTS	FRAME	CAT. NO.	MODEL NO.	STOCK	CT SPEED RANGE*	LIST PRICE	MULT. SYMB.	NOM. EFF.	F.L. AMPS	WEIGHT	"C" DIM.	BRAKE RATING (Lb/Ft)	FOOT NOTES
1/3	1800	208-230/460	56C	N351	056T17V99006	✓	1000:1	\$774	F3	72.0	1.4-1.3/65	40	14.00	3	N
1/2	1800	208-230/460	56C	N353	056T17V99007	✓	1000:1	\$789	F3	78.5	2.0-1.8/9	42	14.50	3	N
3/4	1800	208-230/460	56C	N355	056T17V99008	✓	1000:1	\$937	F3	80.0	2.7-2.5/1.25	44	15.00	6	N
1	1800	208-230/460	56C	N357	056T17V99005	✓	1000:1	\$968	F3	80.0	3.3-3.2/1.6	48	15.50	6	N
	1800	208-230/460	143TC	N358	143TTVR5331	✓	1000:1	\$968	F3	80.0	3.3-3.2/1.6	49	16.06	6	N
1 1/2	1800	208-230/460	145TC	<b>N360</b>	145TTWR14032	✓	10:1	\$1,342	F3	84.0	4.5-4.4/2.2	50	19.01	10	V,5
	2	1800	208-230/460	145TC	<b>N362</b>	145TTWR14033	✓	10:1	\$1,391	F3	84.0	6-5.6/2.8	62	19.01	10

## Brakemotor C-Face Footless

HP	RPM	VOLTS	FRAME	CAT. NO.	MODEL NO.	STOCK	CT SPEED RANGE*	LIST PRICE	MULT. SYMB.	NOM. EFF.	F.L. AMPS	WEIGHT	"C" DIM.	BRAKE RATING (Lb/Ft)	FOOT NOTES
1/3	1800	208-230/460	56C	N371	056T17V99003	✓	1000:1	\$747	F3	72.0	1.4-1.3/65	39	14.00	3	N
1/2	1800	208-230/460	56C	N373	056T17V99004	✓	1000:1	\$766	F3	78.5	2.0-1.8/9	41	14.50	3	N
3/4	1800	208-230/460	56C	N375	056T17V99002	✓	1000:1	\$911	F3	80.0	2.7-2.5/1.25	43	15.00	6	N
1	1800	208-230/460	56C	N377	056T17V99009	✓	1000:1	\$944	F3	80.0	3.3-3.2/1.6	45	15.50	6	N
	1800	208-230/460	143TC	N378	143TTVR5330	✓	1000:1	\$944	F3	80.0	3.3-3.2/1.6	46	15.56	6	N
1 1/2	1800	208-230/460	145TC	<b>N380</b>	145TTWR17031	✓	10:1	\$1,308	F3	78.5	4.6-5.0/2.5	49	18.01	10	V,5
	2	1800	208-230/460	145TC	<b>N382</b>	145TTWR17032	✓	10:1	\$1,345	F3	81.5	6.2-6.2/3.1	61	18.51	10

Catalog numbers (Cat No.) highlighted in bold blue have efficiency levels that meet EISA requirements

# PowerWash™ SXT Washdown Duty, Single Phase

## All Stainless Steel, Totally Enclosed

### Features:

- Encapsulated electronic starting switch is impervious to moisture
- Capacitor start induction run design for high starting torque unless otherwise noted
- 1.15 Service Factor on sinewave
- Double sealed ball bearings
- 303 stainless steel shaft with spring loaded contact seals in each end.
- 300 Series Stainless steel external construction: frame, endshields, conduit box, fan guard, mounting base and hardware for superior corrosion resistance
- Internal corrosion resistant coatings on rotor and heavy polyester varnish on the stator.
- 100% Paint-free constructions
- One way condensation drains in each endshield and conduit box for all angle mounting
- Nitrile Buna - N gaskets and seals on conduit box, through bolts and endshields
- Nameplate information laser etched on frame
- UL Recognized, CSA Certified and CE Mark



### C-Face Footed (Rigid Base)

HP	RPM	VOLTS	FRAME	CAT. NO.	LIST PRICE	MULT. SYMB.	F.L. AMPS	WEIGHT	"C" DIM.	FOOT NOTES
1/2	3600	115/208-230	56C	N340	\$471	F3	7.4/3.7	29.5	11.10	
	1800	115/208-230	56C	N341	\$531	F3	8.2/4.1	31.5	11.10	
3/4	3600	115/208-230	56C	N342	\$518	F3	9.2/4.6	31.5	11.80	
	1800	115/208-230	56C	N343	\$613	F3	9.8/4.9	39.0	11.80	
1	3600	115/208-230	56C	N344	\$609	F3	12.4/6.2	39.0	12.30	
	1800	115/208-230	56C	N345	\$639	F3	13.6/6.8	42.5	12.30	
1 1/2	3600	115/208-230	56C	N346	\$670	F3	16.4/8.5-8.2	42.5	13.20	
	1800	115/208-230	56C	N347	\$668	F3	15.8/7.9	52.5	13.20	
2	3600	115/208-230	145TC	N348	\$865	F3	19/9.5	64.5	14.20	
	1800	115/208-230	145TC	N349	\$847	F3	16.4/8.2	64.5	14.20	

WASHDOWN - Painted and Stainless Steel



# PowerWash™ SXT Washdown Duty, Three Phase

## All Stainless Steel, Totally Enclosed

### Features:

- Suitable for use on VFD 10:1 Variable torque, 10:1 (TEFC) or 1000:1 (TENV) Constant Torque
- MAX GUARD® Class F insulation system
- 1.15 Service Factor on sinewave, 1.0 Service Factor on IGBT power
- Double sealed ball bearings
- 303 stainless steel shaft with spring loaded contact seals in each end. (Drive end only on TENV)
- 300 Series Stainless steel external construction: frame, endshields, conduit box, mounting base and hardware for superior corrosion resistance
- Internal corrosion resistant coatings on rotor and heavy polyester varnish on the stator
- 100% Paint-free construction
- One way condensation drains in each endshield and conduit box for all angle mounting
- Nitrile Buna - N gaskets and seals on conduit box, through bolts and endshields
- Rated 60/50 hertz, 190/380 volt at next lower horsepower
- Nameplate information laser etched on frame
- UL Recognized, CSA Certified and CE Mark



### C-Face Footless

HP	RPM	VOLTS	FRAME	CAT. NO.	MODEL NO.	STOCK	LIST PRICE	MULT. SYMB.	NOM. EFF.	F.L. AMPS	WEIGHT	"C" DIM.	FOOT NOTES
1/3	1800	208-230/460	56C	N430	056T17VD5329	✓	\$512	F3	78.5	1.2-1.3/1.65	30	9.78	N
1/2	1800	208-230/460	56C	N431	056T17VD5330	✓	\$525	F3	81.5	1.5-1.6/1.8	33	9.78	N
	1200	208-230/460	56C	N427			\$611	F3	78.5	2.1-2.0/1.0	35	9.76	N
3/4	1800	208-230/460	56C	N432	056T17VD5331	✓	\$610	F3	82.5	2.4-2.3/1.2	38	9.78	N
	1200	208-230/460	56C	N428			\$689	F3	80.0	3.0-3.0/1.5	47	11.30	N
1	1800	208-230/460	56C	N429			\$636	F3	81.5	3.1-3.0/1.5	45	11.00	N
	1800	208-230/460	56C	N433	056T17WD5330	✓	\$636	F3	82.5	3.2-3.0/1.5	47	13.77	
	1800	208-230/460	143TC	<b>N434A</b>	143TTWD4527	✓	\$705	F3	85.5	3.2-3.0/1.5	47	13.62	
	1200	208-230/460	56C	<b>N436</b>			\$718	F3	82.5	3.8-3.8/1.9	47	13.10	
1 1/2	1800	208-230/460	56C	N435	056T17WD5331	✓	\$664	F3	84.0	5.8-5.4/4.4	48	13.77	
	1800	208-230/460	145TC	<b>N439</b>			\$754	F3	84.0	5.0-4.8/2.4	48	13.62	
2	1800	208-230/460	56C	N437	056T17WD5332	✓	\$758	F3	84.0	6.2-5.8/2.9	52	13.77	
	1800	208-230/460	145TC	<b>N438A</b>	145TTWD4528	✓	\$838	F3	84.0	6.2-5.8/2.9	52	13.62	

Catalog numbers (Cat No.) highlighted in bold blue have efficiency levels that meet EISA requirements

WASHDOWN - Painted and Stainless Steel

# PowerWash™ SXT Washdown Duty, Three Phase

All Stainless Steel, Totally Enclosed



## C-Face Footed (Rigid Base)

HP	RPM	VOLTS	FRAME	CAT. NO.	MODEL NO.	STOCK	LIST PRICE	MULT. SYMB.	NOM. EFF.	F.L. AMPS	WEIGHT	"C" DIM.	FOOT NOTES
1/3	3600	208-230/460	56C	N450	056T34VD5301	✓	\$461	F3	74.0	1.1-1.0/0.5	29	9.78	N
	1800	208-230/460	56C	N410	056T17VD5326	✓	\$515	F3	78.5	1.2-1.3/.65	30	9.78	N
1/2	3600	208-230/460	56C	N451	056T34VD5302	✓	\$471	F3	77.0	1.6-1.5/.75	32	9.78	N
	1800	208-230/460	56C	N411	056T17VD5328	✓	\$530	F3	81.5	1.5-1.6/.8	33	9.78	N
	1800	208-230/460	56C	N494			\$530	F3	81.5	1.5-1.6/.8	34	13.77	
	1200	208-230/460	56C	N495			\$649	F3	78.5	2.2-2.0/1.0	36	9.79	N
3/4	3600	208-230/460	56C	N452	056T34VD5303	✓	\$517	F3	78.5	2.2-2.0/1.0	33	9.78	N
	1800	208-230/460	56C	N412	056T17VD5327	✓	\$613	F3	82.5	2.4-2.3/1.15	38	9.78	N
	1800	208-230/460	56C	N496			\$613	F3	82.5	2.4-2.3/1.2	39	13.77	
	1200	208-230/460	56C	N497			\$728	F3	80.0	3.2-3.0/1.5	49	11.30	N
1	3600	208-230/460	56HC	N453	056T34WD5301	✓	\$608	F3	80.0	2.9-2.6/1.3	41	13.77	5
	3600	208-230/460	143TC	<b>N454A</b>	143TTWD6001	✓	\$764	F3	80.0	2.9-2.6/1.3	42	13.62	
	1800	208-230/460	56C	N413	056T17WD5326	✓	\$638	F3	81.5	3.2-3.0/1.5	46	11.00	5
	1800	208-230/460	56HC	N416			\$638	F3	82.5	3.2-3.0/1.5	47	13.77	5
	1800	208-230/460	143TC	<b>N414A</b>	143TTWD6026	✓	\$858	F3	85.5	3.2-3.0/1.5	48	13.62	
	1200	208-230/460	56HC	N498			\$811	F3	82.5	4.2-3.8/1.9	49	13.10	5
	1200	208-230/460	145TC	<b>N499</b>			\$1,021	F3	82.5	4.2-3.8/1.9	49	13.20	
	1 1/2	3600	208-230/460	56HC	N455	056T34WD5302	✓	\$670	F3	82.5	4.2-3.8/1.9	48	13.77
2	3600	208-230/460	143TC	N456	143TTWD4002	✓	\$726	F3	82.5	4.2-3.8/1.9	48	13.87	d
	3600	208-230/460	143TC	<b>N456A</b>	143TTWD6002	✓	\$902	F3	84.0	4.2-3.8/1.9	49	13.62	
	1800	208-230/460	56HC	N415	056T17WD5329	✓	\$666	F3	84.0	5.0-4.8/2.4	40	13.77	5
	1800	208-230/460	145TC	<b>N419</b>			\$892	F3	86.5	5.0-4.8/2.4	49	13.62	
	3600	208-230/460	56HC	N457	056T34WD5303	✓	\$743	F3	84.0	5.6-5.0/2.5	49	13.77	5
3	3600	208-230/460	145TC	<b>N458A</b>	145TTWD6001	✓	\$1,081	F3	85.5	5.6-5.0/2.5	50	13.62	
	1800	208-230/460	56HC	N417	056T17WD5328	✓	\$760	F3	84.0	6.2-5.8/2.9	52	13.77	5
	1800	208-230/460	145TC	<b>N418A</b>	145TTWD6029	✓	\$1,059	F3	86.5	6.2-5.8/2.9	53	13.62	
3	3600	208-230/460	145TC	<b>N459</b>			\$1,247	F3	86.5	8.0-7.2/3.6	62	14.12	

Catalog numbers (Cat No.) highlighted in bold blue have efficiency levels that meet EISA requirements

WASHDOWN - Painted and Stainless Steel

# PowerWash™ SXT-Plus Washdown Duty, Single Phase

## Stainless/BISSC, Totally Enclosed

### Features:

- Encapsulated electronic starting switch is impervious to moisture
- Capacitor start induction run design for high starting torque, except as noted
- 1.15 Service Factor on sinewave
- Double sealed ball bearings with moisture resistant, high temperature grease
- 303 stainless steel shaft with spring loaded contact seals in each end.
- 300 Series Stainless steel external construction: frame, endshields, conduit box, fan guard, mounting base and hardware for superior corrosion resistance
- Internal corrosion resistant coatings on rotor and heavy polyester varnish on the stator.
- 100% Paint-free constructions
- Viton® o-rings, shaft seals, and gaskets for superior sealing against chemicals
- Hydrophobic breather in OP endshield and conduit box equalize air pressure
- Nameplate information laser etched on frame
- BISSC Certified for baking industry
- UL Recognized, CSA Certified and CE Mark



**IP56**

### C-Face Footless

HP	RPM	VOLTS	FRAME	CAT. NO.	MODEL NO.	STOCK	LIST PRICE	MULT. SYMB.	F.L. AMPS	WEIGHT	"C" DIM.	FOOT NOTES
1/3	1800	115/208-230	56C	N270	056C17V5304	✓	\$689	F3	5.4/3.0-2.7	35	11.70	N
1/2	1800	115/208-230	56C	N271	056C17V5302	✓	\$832	F3	6.6/3.5-3.3	38	12.70	N
3/4	1800	115/208-230	56C	N272	056B17V5301	✓	\$929	F3	7.6/4.2-3.8	42	12.70	N,1
1	1800	115/208-230	56C	N273	056B17V5302	✓	\$949	F3	9.0/5.0-4.5	49	13.70	N,1
1 1/2	1800	115/208-230	145TC	N274	145TBWD5327	✓	\$1,012	F3	14.8/7.8-7.4	53	14.87	1
2	1800	115/208-230	145TC	N275	145TBWD5326	✓	\$1,243	F3	20.0/10.2-10.0	57	14.87	1

### C-Face Footed (Rigid Base)

HP	RPM	VOLTS	FRAME	CAT. NO.	MODEL NO.	STOCK	LIST PRICE	MULT. SYMB.	F.L. AMPS	WEIGHT	"C" DIM.	FOOT NOTES
1/3	1800	115/208-230	56HC	N280	056C17V5303	✓	\$692	F3	5.4/3.0-2.7	35	12.20	N,5
1/2	3600	115/208-230	56HC	N281	056C34V5302	✓	\$807	F3	7.6/4.0-3.8	38	12.20	N,5
	1800	115/208-230	56HC	N282	056C17V5301	✓	\$840	F3	6.6/3.5-3.3	38	12.70	N,5
3/4	1800	115/208-230	56HC	N283	056B17V5303	✓	\$937	F3	7.6/4.2-3.8	42	12.70	N,1,5
1	3600	115/208-230	56HC	N284	056C34V5301	✓	\$899	F3	12.0/6.8-6.0	49	13.70	N,5
	1800	115/208-230	56HC	N285	056B17V5304	✓	\$962	F3	9.0/5.0-4.5	49	13.70	N,1,5
1 1/2	3600	115/208-230	56HC	N286	056B34W5301	✓	\$947	F3	13.6/7.2-6.8	49	13.81	V,1
	1800	115/208-230	145TC	N287	145TBWD5329	✓	\$1,020	F3	14.8/7.8-7.4	53	14.81	V,1
2	3600	115/208-230	145TC	N288	145TBWD5301	✓	\$1,128	F3	17.6/9.8-8.8	57	14.81	V,1
	1800	115/208-230	145TC	N289	145TBWD5328	✓	\$1,251	F3	20.0/10.2-10.0	57	14.81	V,1

WASHDOWN - Painted and Stainless Steel

# PowerWash™ SXT-Plus Washdown Duty, Three Phase

## Stainless/BISSC, Totally Enclosed

### Features:

- Suitable for use on VFD, 10:1 Variable torque, 10:1 (TEFC) or 1000:1 (TENV) Constant Torque, 1.0 Service Factor
- MAX GUARD® Class F insulation system
- 1.15 Service Factor on sinewave, 1.0 Service Factor on IGBT power
- Double sealed ball bearings with moisture resistant, high temperature grease
- 300 Series Stainless steel external construction: frame, endshields, shaft, conduit box, mounting base and hardware for superior corrosion resistance
- Internal corrosion resistant coatings on rotor and heavy polyester varnish on the stator
- 100% Paint-free construction
- Viton® o-rings, shaft seals, and gaskets for superior sealing against chemicals
- Hydrophobic breather in OP endshield and conduit box equalize air pressure
- Nameplate information laser etched on frame
- BISSC Certified for baking industry
- UL Recognized, CSA Certified and CE Mark



### C-Face Footless

HP	RPM	VOLTS	FRAME	CAT. NO.	MODEL NO.	STOCK	LIST PRICE	MULT. SYMB.	NOM. EFF.	F.L. AMPS	WEIGHT	"C" DIM.	FOOT NOTES
1/3	1800	208-230/460	48C	N460	048T17V2001	✓	\$896	F3	70.5	1.3-1.3/65	25	9.83	N
1/2	3600	208-230/460	56C	N480	056T34V5316	✓	\$841	F3	82.5	1.7-1.6/8	35	12.04	N
	1800	208-230/460	48C	N461	048T17V2002	✓	\$919	F3	76.0	1.9-1.8/0.9	27	11.58	N
	1800	208-230/460	56C	N462	056T17V5353	✓	\$975	F3	78.5	1.7-1.6/8	34	12.54	N
3/4	3600	208-230/460	56C	N481	056T34V5317	✓	\$925	F3	84.0	2.6-2.4/1.2	40	12.54	N
	1800	208-230/460	56C	N463	056T17V5352	✓	\$998	F3	80.0	2.4-2.3/1.2	40	13.04	N
1	3600	208-230/460	56C	N482	056T34V5313	✓	\$982	F3	85.5	2.8-2.6/1.3	43	13.04	N
	1800	208-230/460	56C	N464	056T17V5356	✓	\$1,113	F3	81.5	3.1-3/1.5	44	13.54	N
	1800	208-230/460	56HC	N465	056T17W5331	✓	\$1,113	F3	82.5	3.2-3.1/1.6	45	13.13	5
	1800	208-230/460	143TC	N466	143TTVD5327	✓	\$1,234	F3	81.5	3.1-3.0/1.5	44	13.61	N
	1800	208-230/460	143TC	<b>N467</b>	143TTWD14032	✓	\$1,272	F3	82.5	3.2-3.1/1.55	51	13.19	V
1 1/2	3600	208-230/460	143TC	<b>N483</b>	143TTWD14003	✓	\$1,005	F3	82.5	4.4-4.4-4/2	52	13.69	V
	1800	208-230/460	56C	N468	056T17W5330	✓	\$1,162	F3	84.0	4.5-4.4/2.2	49	13.63	V
	1800	208-230/460	145TC	<b>N469</b>	145TTWD14034	✓	\$1,323	F3	84.0	4.5-4.4/2.2	55	13.69	V
2	3600	208-230/460	145TC	<b>N484</b>	145TTWD14005	✓	\$1,099	F3	84.0	5.6-5.2/2.6	54	13.69	V
	1800	208-230/460	56C	N470	056T17W5332	✓	\$1,187	F3	84.0	6.0-5.6/2.8	49	13.63	V
	1800	208-230/460	145TC	<b>N471</b>	145TTWD14033	✓	\$1,347	F3	84.0	6.0-5.6/2.8	60	13.69	V
3	3600	208-230/460	145TC	<b>N485</b>	145TTWD14004	✓	\$1,215	F3	85.5	8.4-7.6/3.8	55	13.69	V
	1800	208-230/460	182TC	<b>N472</b>	182TTWD14032	✓	\$1,809	F3	87.5	8.0-8.6/4.3	88	14.77	V
5	3600	208-230/460	184TC	<b>N486</b>	184TTWD14002	✓	\$1,587	F3	87.5	13.0-12.0/6.0	98	14.77	V,13
	1800	208-230/460	184TC	<b>N473</b>	184TTWD14032	✓	\$1,998	F3	87.5	14.0-13.0/6.5	102	15.27	V,13

Catalog numbers (Cat No.) highlighted in bold blue have efficiency levels that meet EISA requirements

WASHDOWN - Painted and Stainless Steel

# PowerWash™ SXT-Plus Washdown Duty, Three Phase

## Stainless/BISSC, Totally Enclosed

### C-Face Footed (Rigid Base)

HP	RPM	VOLTS	FRAME	CAT. NO.	MODEL NO.	STOCK	LIST PRICE	MULT. SYMB.	NOM. EFF.	F.L. AMPS	WEIGHT	"C" DIM.	FOOT NOTES
1/2	3600	208-230/460	56HC	N441	056T34V5314	✓	\$857	F3	82.5	1.7-1.6/8	35	12.04	N,5
	1800	208-230/460	56HC	N400	056T17V5347	✓	\$966	F3	78.0	1.6-1.6/8	37	12.54	N,5
	1200	208-230/460	56HC	N180	056T11V5379	✓	\$963	F3	77.0	2.4-2.3/1.2	35	12.54	N,5
3/4	3600	208-230/460	56HC	N442	056T34V5312	✓	\$941	F3	84.0	2.6-2.4/1.2	40	12.54	N,5
	1800	208-230/460	56HC	N401	056T17V5348	✓	\$1,003	F3	80.0	2.4-2.3/1.15	42	13.04	N,5
	1200	208-230/460	56HC	N181	056T11V5380	✓	\$1,012	F3	78.5	3.1-3.0/1.5	46	14.04	N,5
1	3600	208-230/460	56HC	N443	056T34V5315	✓	\$1,107	F3	85.5	2.8-2.6/1.3	43	13.04	N,5
	1800	208-230/460	56HC	N402	056T17V5349	✓	\$1,026	F3	81.5	2.4-2.3/1.15	47	13.54	N,5
	1800	208-230/460	56HC	N291	056T17W5329	✓	\$1,026	F3	82.5	3.2-3.1/1.6	39	13.13	V,5
	1800	208-230/460	143TC	N403	143TTVD5326	✓	\$1,026	F3	81.5	3.1-3.0/1.5	50	13.61	N
	1800	208-230/460	143TC	<b>N292</b>	143TTWD16031	✓	\$1,026	F3	85.5	3.2-3.2/1.6	50	13.19	
	1200	208-230/460	56HC	N182	056T11W5379	✓	\$1,065	F3	77.0	3.8-4.0/2.0	48	13.13	5
1 1/2	3600	208-230/460	143TC	<b>N444</b>	143TTWD16002	✓	\$1,321	F3	84.0	4.4-4.0/2.0	45	13.69	
	1800	208-230/460	56HC	N293	056T17W5336	✓	\$1,098	F3	84.0	4.5-4.4/2.2	49	13.63	5
	1800	208-230/460	145TC	<b>N404A</b>	145TTWD6026	✓	\$1,200	F3	86.5	4.5-4.4/2.2	52	13.69	
	1200	208-230/460	56HC	N183	056T11W5380	✓	\$1,287	F3	80.0	5.9-5.4/2.7	51	14.13	5
2	3600	208-230/460	145TC	<b>N445</b>	145TTWD16003	✓	\$1,967	F3	85.5	5.2-4.8/2.4	49	13.69	
	1800	208-230/460	56HC	N294	056T17W5337	✓	\$1,383	F3	84.0	6.0-5.6/2.8	50	13.63	5
	1800	208-230/460	145TC	<b>N405A</b>	145TTWD6027	✓	\$1,491	F3	86.5	5.6-5.6/2.8	50	13.69	
3	3600	208-230/460	145TC	<b>N446</b>	145TTWD16002	✓	\$2,007	F3	86.5	8.8-8.0/4.0	53	13.69	
	1800	208-230/460	182TC	<b>N406A</b>	182TTWD6031	✓	\$1,791	F3	89.5	8.8-8.2/4.1	85	14.77	13
5	3600	208-230/460	184TC	<b>N447</b>	184TTWD16002	✓	\$2,247	F3	88.5	13.0-12.0/6.0	90	14.77	13
	1800	208-230/460	184TC	<b>N407A</b>	184TTWD6031	✓	\$2,043	F3	89.5	13.8-13.0/6.5	96	15.27	13
7 1/2	3600	208-230/460	213TC	<b>N448</b>	213TTWD16002	✓	\$2,956	F3	89.5	19.6-17.8/8.9	160	18.69	
	1800	208-230/460	213TC	<b>N408A</b>	213TTWD6031	✓	\$3,056	F3	91.7	22.4-20.4/10.8	160	18.69	
10	3600	208-230/460	215TC	<b>N449</b>	215TTWD16002	✓	\$3,087	F3	90.2	26.4-23.6/11.8	165	18.69	
	1800	208-230/460	215TC	<b>N409A</b>	215TTWD6031	✓	\$3,148	F3	91.7	28.0-26.0/13.0	173	18.69	

Catalog numbers (Cat No.) highlighted in bold blue have efficiency levels that meet EISA requirements

WASHDOWN - Painted and Stainless Steel

## PowerWash™ Coupler Brakes

PowerWash™ coupler brakes are specifically designed for use with PowerWash™ Washdown Duty motors. Rated for NEMA 4X/IP55, these brakes are suitable for applications with high moisture or pressure washdown. Painted with a special white epoxy food-safe paint, these brakes are **BISSC Certified**.

ENCLOSURE NEMA 4X/IP55	CAT. NO.	KIT NO.	STOCK	LIST PRICE	MULT. SYMB.	WEIGHT
3 Lb/Ft	A909	KIT 909	✓	\$755	S4	12
6 Lb/Ft	A910	KIT 910	✓	\$816	S4	12
10 Lb/Ft	A911	KIT 911	✓	\$897	S4	12

# PowerWash™ SXT-Plus Washdown Duty, Three Phase

## Stainless/BISSC, Totally Enclosed

### Close Coupled Pump, JM, Rigid Base

Same features as shown on page 114

HP	RPM	VOLTS	FRAME	CAT. NO.	MODEL NO.	STOCK	LIST PRICE	MULT. SYMB.	NOM. EFF.	F.L. AMPS	WEIGHT	"C" DIM.	FOOT NOTES
1	1800	208-230/460	143JM	<b>N151</b>	143TTWD14031	✓	\$823	F3	82.5	3.2-3.1/1.55	55	16.00	V
1 1/2	3600	208-230/460	143JM	<b>N152</b>	143TTWD14002	✓	\$823	F3	82.4	4.4-4.0/2.0	55	16.00	V
	1800	208-230/460	145JM	<b>N153</b>	145TTWD14031	✓	\$840	F3	84.0	4.5-4.4/2.2	56	16.00	V
2	3600	208-230/460	145JM	<b>N154</b>	145TTWD14002	✓	\$978	F3	84.0	5.6-5.2/2.6	56	16.00	V
	1800	208-230/460	145JM	<b>N155</b>	145TTWD14032	✓	\$988	F3	84.0	6.0-5.6/2.8	57	16.50	V
3	3600	208-230/460	145JM	<b>N156</b>	145TTWD14003	✓	\$1,176	F3	85.5	8.4-7.6/3.8	57	16.50	V
	1800	208-230/460	182JM	<b>N157</b>	182TTWD14033	✓	\$1,244	F3	87.5	8.0-8.6/4.3	85	16.20	V,13
5	3600	208-230/460	184JM	<b>N158</b>	184TTWD14003	✓	\$1,372	F3	87.5	13.0-12.0/6.0	90	16.20	V,13
	1800	208-230/460	184JM	<b>N159</b>	184TTWD14033	✓	\$1,379	F3	87.5	14.0-13.0/6.5	96	16.77	V,13
7 1/2	3600	208-230/460	213JM	<b>N160</b>	213TTWD14002	✓	\$2,089	F3	88.5	20.0-18.4/9.2	160	16.81	V
	1800	208-230/460	213JM	<b>N161</b>	213TTWD14032	✓	\$2,135	F3	89.5	24.0-22.0/11.0	162	19.81	V
10	3600	208-230/460	215JM	<b>N162</b>	215TTWD14002	✓	\$2,163	F3	89.5	27.0-24.0/12.0	165	19.81	V
	1800	208-230/460	215JM	<b>N163</b>	215TTWD14032	✓	\$2,202	F3	89.5	29.0-28.0/14.0	173	19.81	V

Catalog numbers (Cat No.) highlighted in bold blue have efficiency levels that meet EISA requirements

### Brakemotor C-Face Footed (Rigid Base)

HP	RPM	VOLTS	FRAME	CAT. NO.	MODEL NO.	STOCK	LIST PRICE	MULT. SYMB.	NOM. EFF.	F.L. AMPS	WEIGHT	BRAKE RATING (Lb/Ft)	"C" DIM.	FOOT NOTES
1/2	1800	208-230/460	56C	N388	056T17V5354	✓	\$2,769	F3	78.5	1.6-1.6/.8	59	3	15.85	N
1	1800	208-230/460	56C	N389	056T17V5355	✓	\$2,917	F3	81.5	3.1-3.0/1.5	69	6	15.85	N

WASHDOWN - Painted and Stainless Steel

# PowerWash™ SXT-Plus Washdown Duty, Three Phase

## Stainless/BISSC, Totally Enclosed

### IEC

#### B5 Footless

HP	RPM	VOLTS	FRAME	CAT. NO.	MODEL NO.	STOCK	LIST PRICE	MULT. SYMB.	NOM. EFF.	F.L. AMPS	WEIGHT	"C" DIM.	FOOT NOTES
1/3 - .25	1800	208-230/460	71	R700	071T17V5326	✓	\$732	F3	70.5	1.3-1.3/.65	30	9.87	N
	1800	208-230/460	80	R701	080T17V5326	✓	\$732	F3	70.5	1.3-1.3/.65	30	9.87	N
1/2 - .37	1800	208-230/460	71	R702	071T17V5327	✓	\$757	F3	76.0	1.9-1.8/0.9	32	11.62	N
	1800	208-230/460	80	R703	080T17V5331	✓	\$757	F3	76.0	1.9-1.8/0.9	32	11.62	N
3/4 - .55	1800	208-230/460	80	R704	080T17W5326	✓	\$802	F3	77.0	2.5-2.4/1.2	38	12.26	V
1 - .75	1800	208-230/460	90	<b>R705</b>	090LT17W4026	✓	\$853	F3	82.5	3.2-3.1/1.55	45	13.13	V
1 1/2 - 1.1	1800	208-230/460	90	<b>R706</b>	090LT17W4027	✓	\$900	F3	84.0	4.5-4.4/2.2	49	13.63	V
2 - 1.5	1800	208-230/460	90	<b>R707</b>	090LT17W4028	✓	\$999	F3	84.0	6.0-5.6/2.8	49	13.63	V

Catalog numbers (Cat No.) highlighted in bold blue have efficiency levels that meet EISA requirements

#### B5 Footed (Rigid Base)

HP	RPM	VOLTS	FRAME	CAT. NO.	MODEL NO.	STOCK	LIST PRICE	MULT. SYMB.	NOM. EFF.	F.L. AMPS	WEIGHT	"C" DIM.	FOOT NOTES
1/3 - .25	1800	208-230/460	80	R710	080T17V5327	✓	\$744	F3	70.5	1.3-1.3/.65	30	9.50	N
1/2 - .37	1800	208-230/460	80	R711	080T17V5333	✓	\$768	F3	76.0	1.9-1.8/0.9	32	12.75	N
3/4 - .55	1800	208-230/460	80	R712	080T17W5327	✓	\$818	F3	77.0	2.5-2.4/1.2	38	12.75	V

#### B14 Footless

HP	RPM	VOLTS	FRAME	CAT. NO.	MODEL NO.	STOCK	LIST PRICE	MULT. SYMB.	NOM. EFF.	F.L. AMPS	WEIGHT	"C" DIM.	FOOT NOTES
1/3 - .25	1800	208-230/460	71	R720	071T17V5328	✓	\$732	F3	70.5	1.3-1.3/.65	30	9.83	N
	1800	208-230/460	80	R721	080T17V5328	✓	\$732	F3	70.5	1.3-1.3/.65	30	9.72	N
1/2 - .37	1800	208-230/460	71	R722	071T17V5329	✓	\$757	F3	76.0	1.9-1.8/0.9	32	11.58	N
	1800	208-230/460	80	R723	080T17V5329	✓	\$757	F3	76.0	1.9-1.8/0.9	32	11.58	N
3/4 - .55	1800	208-230/460	80	R724	080T17W5328	✓	\$802	F3	77.0	2.5-2.4/1.2	38	12.48	V

#### B14 Footed (Rigid Base)

HP	RPM	VOLTS	FRAME	CAT. NO.	MODEL NO.	STOCK	LIST PRICE	MULT. SYMB.	NOM. EFF.	F.L. AMPS	WEIGHT	"C" DIM.	FOOT NOTES
1/3 - .25	1800	208-230/460	80	R730	080T17V5330	✓	\$757	F3	70.5	1.3-1.3/.65	31	9.72	N
1/2 - .37	1800	208-230/460	80	R731	080T17V5332	✓	\$837	F3	76.0	1.9-1.8/0.9	33	11.58	N
3/4 - .55	1800	208-230/460	80	R732	080T17W5329	✓	\$866	F3	77.0	2.5-2.4/1.2	39	12.48	V

WASHDOWN - Painted and Stainless Steel

# PowerWash™ Extreme Washdown Duty, Three Phase

## Stainless/BISSC, Totally Enclosed

### Features:

- Complete motor Encapsulation
- Suitable for use on VFD 10:1 Variable torque, 10:1 (TEFC) or 1000:1 (TENV) Constant Torque, 1.0 Service Factor
- MAX GUARD® Class F insulation system
- Potted lead entrance
- 1.15 Service Factor on sinewave, 1.0 Service Factor on IGBT power
- Double sealed ball bearings with moisture resistant, high temperature grease
- 300 Series Stainless steel external construction: frame, endshields, shaft, conduit box, mounting base and hardware for superior corrosion resistance
- 100% Paint-free constructions
- Viton® o-rings, shaft seals, and gaskets for superior sealing against chemicals
- Nameplate information laser etched on frame
- BISSC Certified for baking industry
- UL Recognized, CSA Certified and CE Mark



### C-Face Footless

HP	RPM	VOLTS	FRAME	CAT. NO.	MODEL NO.	STOCK	LIST PRICE	MULT. SYMB.	NOM. EFF.	F.L. AMPS	WEIGHT	"C" DIM.	FOOT NOTES
1/3	1800	208-230/460	48C	N701	048T17V11001	✓	\$1,183	F3	70.5	1.3-1.3/.65	30	9.58	N
1/2	3600	208-230/460	56C	N703	056T34V99013	✓	\$1,110	F3	82.5	1.7-1.6/.8	38	10.47	N
	1800	208-230/460	48C	N704	048T17V11002	✓	\$1,213	F3	76.0	1.7-1.6/.8	32	11.33	N
	1800	208-230/460	56C	N705	056T17V99016	✓	\$1,287	F3	78.5	1.7-1.6/.8	39	10.72	N
3/4	3600	208-230/460	56C	N707	056T34V99014	✓	\$1,221	F3	84.0	2.6-2.4/1.2	45	10.47	N
	1800	208-230/460	56C	N708	056T17V99011	✓	\$1,317	F3	80.0	2.4-2.3/1.2	46	11.22	N
1	3600	208-230/460	56C	N710	056T34V99011	✓	\$1,296	F3	85.5	2.8-2.6/1.3	47	10.97	N
	1800	208-230/460	56C	N711	056T17V99012	✓	\$1,469	F3	81.5	3.1-3.0/1.5	50	11.69	N
1 1/2	3600	208-230/460	143TC	<b>N713</b>	143TTWD16004	✓	\$1,327	F3	82.5	4.4-4.0/2.0	53	11.75	
	1800	208-230/460	56C	N715	056T17W99007	✓	\$1,534	F3	84.0	4.5-4.4/2.2	55	11.69	
	1800	208-230/460	145TC	<b>N716</b>	143TTWD16033	✓	\$1,746	F3	84.0	4.5-4.4/2.2	55	12.75	
2	3600	208-230/460	145TC	<b>N718</b>	145TTWD16004	✓	\$1,451	F3	84.0	5.6-5.2/2.6	55	12.75	
	1800	208-230/460	56C	N720	145TTWD16032	✓	\$1,567	F3	84.0	6.0-5.6/2.8	56	13.25	
	1800	208-230/460	145TC	<b>N721</b>	056T17W99009	✓	\$1,778	F3	84.0	6.0-5.6/2.8	56	12.69	

### C-Face Footed (Rigid Base)

HP	RPM	VOLTS	FRAME	CAT. NO.	MODEL NO.	STOCK	LIST PRICE	MULT. SYMB.	NOM. EFF.	F.L. AMPS	WEIGHT	"C" DIM.	FOOT NOTES
1/2	3600	208-230/460	56C	N753	056T34V99012	✓	\$1,131	F3	82.5	1.7-1.6/.8	39	10.47	N
	1800	208-230/460	56C	N755	056T17V99015	✓	\$1,275	F3	78.5	1.7-1.6/.8	40	10.72	N
3/4	3600	208-230/460	56C	N757	056T34V99015	✓	\$1,242	F3	84.0	2.6-2.4/1.2	46	10.47	N
	1800	208-230/460	56C	N758	056T17V99014	✓	\$1,324	F3	80.0	2.4-2.3/1.15	47	11.22	N
1	3600	208-230/460	56C	N760	056T34V99016	✓	\$1,461	F3	85.5	2.8-2.6/1.3	48	10.37	N
	1800	208-230/460	56C	N761	056T17V99013	✓	\$1,354	F3	81.5	3.1-3.0/1.5	50	11.97	N
1 1/2	3600	208-230/460	143TC	<b>N763</b>	143TTWD16003	✓	\$1,744	F3	84.0	4.4-4.0/2.0	54	11.75	
	1800	208-230/460	56C	N765	056T17W99010	✓	\$1,449	F3	84.0	4.5-4.4/2.2	56	11.69	
	1800	208-230/460	145TC	<b>N766</b>	143TTWD16032	✓	\$1,584	F3	86.5	4.5-4.4/2.2	56	12.75	
2	3600	208-230/460	145TC	N768	145TTWD16005	✓	\$2,596	F3	85.5	5.6-5.2/2.6	56	12.75	
	1800	208-230/460	56C	N770	056T17W99008	✓	\$1,826	F3	84.0	6.0-5.6/2.8	57	12.69	
	1800	208-230/460	145TC	<b>N771</b>	145TTWD16031	✓	\$1,968	F3	86.5	5.6-5.6/2.8	57	13.25	

Catalog numbers (Cat No.) highlighted in bold blue have efficiency levels that meet EISA requirements



# Carbonator Pump, Split Phase Dripproof

## Features:

- Ball bearings
- 1.0 Service Factor (except as noted)
- Completely interchangeable with OEM units
- Automatic reset thermal protector
- UL Recognized and CSA Certified



Single Shaft



Double Shaft

HP	RPM	VOLTS	FRAME	CAT. NO.	MODEL NO.	STOCK	LIST PRICE	MULT. SYMB.	F.L. AMPS	WEIGHT	"C" DIM.	FOOT NOTES
1/4	1800/1500	208-240	48Y	H451	5KH32GNB813X	✓	\$167	F1	2.3-2.4	14	7.69	12,68
	1800/1500	115/230	48Z	H344	5KH36KNB633X	✓	\$139	F1	4.3/2.2	16	8.75	12,d
	1800	115	48Y	4725	5KH32DN5587X	✓	\$139	F1	5.0	13	7.69	12
	1800	115	48Y	HG679	5KH32DN5597X	✓	\$132	F1	5.0	11	7.69	82
1/3	1800/1500	100-120/200-240	48Y	HG681	5KH32GNB814X	✓	\$174	F1	5.5-5.6/2.7-2.8	14	7.69	68,82
	1800/1500	100-120/200-240	48Y	H683	5KH33GNA444X	✓	\$196	F1	5.5-5.6/2.7-2.8	14	7.94	12
	1800/1500	100-120/200-240	48Y	4805	5KH32GNB811X	✓	\$182	F1	5.5-5.6/2.7-2.8	14	7.69	12,68
	1800/1500	220-240	48Y	HG450	5KH32GNB812X	✓	\$176	F1	2.7-2.7	14	7.69	12,68
	1800	115	48Y	4406	5KH32FN5586X	✓	\$152	F1	5.6	14	7.69	12,18
	1800	115	48Y	HG680	5KH32FN5598X	✓	\$146	F1	5.6	14	7.69	18,82
	1800	115	48Y	H682	5KH32ENA443X	✓	\$176	F1	6.1	13	7.69	12
	1800	115	48Y	H926	5KH36MNB637X	✓	\$227	F1	7.2	17	8.75	12
1/2	1800/1500	100-120/200-240	48Y	H684	5KH36MNA445X	✓	\$227	F1	7.1-7.2/3.4-3.6	17	8.75	12,68
	3/4	1800	115/230	48Y	HG714	5KH37PNA479X	✓	\$302	F1	10.4/5.2	19	9.15

## Double Shaft

HP	RPM	VOLTS	FRAME	CAT. NO.	MODEL NO.	STOCK	LIST PRICE	MULT. SYMB.	F.L. AMPS	WEIGHT	"C" DIM.	FOOT NOTES
1/3	1800/1500	100-120/200-240	48Y	H712	5KH32GNB815X	✓	\$186	F1	5.5-5.6/2.7-2.8	14	9.47	68

# Sump Pump, Split Phase Dripproof

## Features:

- Sleeve bearings
- 1.0 Service Factor
- Float switch & cord set
- Completely interchangeable with OEM units
- Automatic reset thermal protector
- UL Recognized and CSA Certified



PUMP MOTORS (FLUID HANDLING)

HP	RPM	VOLTS	FRAME	CAT. NO.	MODEL NO.	STOCK	LIST PRICE	MULT. SYMB.	F.L. AMPS	WEIGHT	"C" DIM.	FOOT NOTES
1/3	1800	115	48K	H641	5KH39CN5501X	✓	\$162	F1	5.7	12	9.6	4,15,d
	1800	115	48K	H642	5KH39CN5504X	✓	\$162	F1	5.7	12	9.6	4,16
1/4	1800	115	48K	H950	5KH140DFK1X	✓	\$162	F1	5.0	11	7.9	4,15
1/2	1800	115	48K	H951	5KH140DFK17X	✓	\$212	F1	7.3	17	8.7	4,15

# Jet Pump, Two-Compartment

## Single Phase, Dripproof

Features:

- Two-compartment design for easy servicing
- Not for use in pool pump applications
- 50° C Ambient
- Fixed CW rotation, viewed opposite shaft end
- UL Recognized and CSA Certified



### C-Face Footless, 56C/56J

HP	RPM	VOLTS	FRAME	CAT. NO.	MODEL NO.	STOCK	LIST PRICE	MULT. SYMB.	SERVICE FACTOR	F.L. AMPS	WEIGHT	"C" DIM.	FOOT NOTES
1/3	3600	115	56C	H439	5KH39EN2552X	✓	\$189	F1	1.75	6.2	18	11.03	3
	3600	115	56J	H440	5KH39EN2506X	✓	\$192	F1	1.75	6.2	18	11.54	3
	3600	115	56J	H685	5KH39EN2887X	✓	\$200	F1	1.75	6.2	13	11.54	3,d
	3600	115/230	56C	C1081	5KC39EN2553X	✓	\$209	F1	1.75	6.2/3.1	15	11.03	2
	3600	115/230	56J	C1087	5KC39EN2500X	✓	\$215	F1	1.75	6.2/3.1	15	11.54	2
1/2	3600	115/230	56C	C1082	5KC39HN2554X	✓	\$219	F1	1.6	8.2/4.1	15	11.03	2
	3600	115/230	56J	C1088	5KC39HN2501X	✓	\$224	F1	1.6	8.2/4.1	15	11.54	2
	3600	115/230	56J	C1462	5KC39HN2888X	✓	\$230	F1	1.6	8.2/4.1	16	11.54	12,18
3/4	3600	115/230	56C	C1083	5KC33MN2555X	✓	\$243	F1	1.5	11.6/5.8	17	12.01	18,82
	3600	115/230	56J	C1089	5KC33MN2502X	✓	\$249	F1	1.5	11.6/5.8	17	12.42	2
	3600	115/230	56J	C1463	5KC33MN2889X	✓	\$256	F1	1.5	11.6/5.8	19	12.42	2,d
1	3600	115/230	56C	C1084	5KC39SN2810X	✓	\$278	F1	1.4	14.2/7.1	25	13.47	2
	3600	115/230	56J	C1090	5KC39SN2812X	✓	\$285	F1	1.4	14.2/7.1	26	13.98	2
	3600	115/230	56J	C1464	5KC39SN2890X	✓	\$289	F1	1.4	14.2/7.1	26	13.98	2
1 1/2	3600	115/230	56C	C1085	5KCR39SN2557X	✓	\$370	F1	1.3	15.8/7.9	21	13.47	1
	3600	115/230	56J	C1091	5KCR39SN2504X	✓	\$377	F1	1.3	15.8/7.9	21	13.98	1
	3600	115/230	56J	C1465	5KCR39SN2891X	✓	\$382	F1	1.3	15.8/7.9	21	13.98	1
2	3600	115/230	56C	C1086	5KCR39UN2558X	✓	\$452	F1	1.2	19.2/9.6	23	13.47	1
	3600	115/230	56J	C1092	5KCR39UN2505X	✓	\$458	F1	1.2	19.2/9.6	23	13.98	1
	3600	115/230	56J	C1466	5KCR39UN2892X	✓	\$463	F1	1.2	19.2/9.6	23	13.98	1



### Square Flange

HP	RPM	VOLTS	FRAME	CAT. NO.	MODEL NO.	STOCK	LIST PRICE	MULT. SYMB.	SERVICE FACTOR	F.L. AMPS	WEIGHT	"C" DIM.	FOOT NOTES
1/3	3600	115/230	56Y	C1168	5KC36GN2507X	✓	\$215	F1	1.95	6.4/3.2	15	11.59	2
1/2	3600	115/230	56Y	C1169	5KC36MN2508X	✓	\$216	F1	1.9	10.8/5.4	17	11.59	2
3/4	3600	115/230	56Y	C1170	5KC38PN2509X	✓	\$227	F1	1.65	12.6/6.3	19	12.59	2
1	3600	115/230	56Y	C1171	5KC38SN2510X	✓	\$256	F1	1.65	16.4/8.2	21	12.59	2
1 1/2	3600	230	56Y	C1172	5KCR39UN2511X	✓	\$293	F1	1.5	7.6	23	13.12	1
2	3600	230	56Y	C1173	5KCR39UN2512X	✓	\$390	F1	1.3	8.7	23	13.12	1

# Centrifugal Pump (Jet Pump)

## Single Phase, Dripproof

### Features:

- Service Factor, as noted
- Double sealed ball bearings, mechanically locked on shaft end
- Capacitor start design for high starting torque
- Capacitor start/capacitor run design for higher efficiency, as noted
- Fixed CW rotation, viewed opposite shaft end
- Automatic reset thermal protector
- 56C = carbon steel shaft with key
- 56J = 416 stainless steel threaded shaft with slinger
- Drip cover not included, see Accessories Section
- UL Recognized and CSA Certified



### C-Face Footless, 56C/56J

HP	RPM	VOLTS	FRAME	CAT. NO.	MODEL NO.	STOCK	LIST PRICE	MULT. SYMB.	SERVICE FACTOR	F.L. AMPS	WEIGHT	"C" DIM.	FOOT NOTES
1/3	3600	115/230	56C	J1025	5KC37FN71X	✓	\$154	F1	1.75	6.4/3.2	14	10.71	3
	3600	115/230	56J	C329	5KC37FN65X	✓	\$162	F1	1.75	6.4/3.2	14	11.22	15
	1800/1500	115/208-230	56J	C683	5KC36LN84X	✓	\$350	F1	1.35	6.0/3.2-3.0	17	10.82	15,50
1/2	3600	115/230	56C	C330	5KC36JN268X	✓	\$169	F1	1.6	7.6/3.8	18	10.31	
	3600	115/230	56J	C331	5KC36JN269X	✓	\$176	F1	1.6	7.6/3.8	18	10.82	15
3/4	3600	115/230	56C	C332	5KC39NN50X	✓	\$199	F1	1.5	11.2/5.6	19	11.84	
	3600	115/230	56J	C333	5KC39QN3219X	✓	\$206	F1	1.5	11.2/5.6	18	12.40	15
	2900	110/220	56C	CG732	5KC39RN114T	✓	\$342	F1	1.5	9.8/4.9	28	12.60	50
1	3600	115/230	56C	C334	5KC39RN44X	✓	\$223	F1	1.4	13.2/6.6	22	12.59	
	3600	115/230	56J	C335	5KC39RN45X	✓	\$229	F1	1.4	13.2/6.6	22	13.14	15
1 1/2	3600	115/208-230	56C	C336	5KC49NN2140X	✓	\$304	F1	1.3	18.4/9.8-9.2	27	11.38	
	3600	115/230	56J	C337	5KC49NN2167X	✓	\$323	F1	1.3	18.4/9.2	26	11.89	
2	3600	115/208-230	56C	C338	5KC49TN2141X	✓	\$377	F1	1.2	21.2/11.5-10.6	38	13.22	
	3600	115/208-230	56J	C339	5KC49TN2170X	✓	\$396	F1	1.2	21.2/10.6	36	13.73	
3	3600	115/230	56C	C340	5KCR48TN2142T	✓	\$699	F1	1.15	29.4/14.7	38	12.66	1
	3600	115/230	56J	C341	5KCR48TN2174T	✓	\$631	F1	1.15	29.4/14.7	38	13.17	1,15

### Additional Features:

- Drip cover included

### C-Face Footed (Rigid Base), 56J

HP	RPM	VOLTS	FRAME	CAT. NO.	MODEL NO.	STOCK	LIST PRICE	MULT. SYMB.	SERVICE FACTOR	F.L. AMPS	WEIGHT	"C" DIM.	FOOT NOTES
1/3	3600	115/208-230	56J	J054	056C34D2118	✓	\$167	F1	1.75	5.6/2.7-2.8	15	10.94	3
1/2	3600	115/208-230	56J	J055	056C34D2119	✓	\$181	F1	1.6	7.4/3.5-3.7	17	11.19	15
3/4	3600	115/208-230	56J	J056	056C34D2120	✓	\$211	F1	1.5	9.8/4.8-4.9	20	11.44	15,50
1	3600	115/208-230	56J	J057	056C34D2121	✓	\$234	F1	1.4	12.0/6.2-6.0	23	12.44	
1 1/2	3600	115/208-230	56J	J058	056B34D2033	✓	\$327	F1	1.3	13.4/7.4-6.7	23	12.43	1
2	3600	115/208-230	56J	J059	056B34D5341	✓	\$402	F1	1.2	18.2/9.8-9.1	33	11.94	1

### Single Phase, Totally Enclosed

#### Features:

- Service Factor, as noted
- Double sealed ball bearings, mechanically locked on shaft end
- Capacitor start design for high starting torque
- Capacitor start/capacitor run design for higher efficiency, as noted
- Reversible CW rotation, viewed opposite shaft end
- Automatic reset thermal protector
- 56C = carbon steel shaft with key
- 56J = 416 stainless steel threaded shaft with slinger
- Drip cover not included
- UL Recognized and CSA Certified



PUMP MOTORS (FLUID HANDLING)

HP	RPM	VOLTS	FRAME	CAT. NO.	MODEL NO.	STOCK	LIST PRICE	MULT. SYMB.	SERVICE FACTOR	F.L. AMPS	WEIGHT	"C" DIM.	FOOT NOTES
1/3	3600	115/230	56J	C1336	5KC33FN4180X	✓	\$282	F1	1.0	5.6/2.8	14	11.87	
1/2	3600	115/230	56J	C465	5KC39QN3218X	✓	\$350	F1	1.15	7.4/3.7	19	11.9	15
3/4	3600	115/230	56C	C847	5KC37NN115X	✓	\$373	F1	1.0	9.8/4.9	22	11.76	
1	3600	115/230	56J	C352	5KC49NN2135X	✓	\$402	F1	1.15	13.0/6.5	27	12.95	15
2	3600	115/230	56J	C878	5KCR49TN2164T	✓	\$604	F1	1.0	17.8/8.9	38	14.79	ES,1,15

# Centrifugal Pump (Jet Pump)

## Three Phase, Dripproof

Features:

- Service Factor, as noted
- Double sealed ball bearings, mechanically locked on shaft end
- Continuous Duty
- Nameplated 60/50 hertz, 190/380 volts at next lower HP, as noted
- 56C = carbon steel shaft with key
- 56J = 416 stainless steel threaded shaft with slinger
- UL Recognized and CSA Certified
- Drip cover not included, see Accessories section



### C-Face Footless, 56C/56J

HP	RPM	VOLTS	FRAME	CAT. NO.	MODEL NO.	STOCK	LIST PRICE	MULT. SYMB.	SERVICE FACTOR	F.L. AMPS	WEIGHT	"C" DIM.	FOOT NOTES
1/3	3600	208-230/460	56C	KG215	5K35FN55	✓	\$177	F1	1.75	1.5-1.8/0.9	14	9.90	68
	3600	208-230/460	56J	K748	5K35FN101	✓	\$178	F1	1.75	1.5-1.8/0.9	14	10.40	48
1/2	3600	208-230/460	56C	K216	5K36JN57	✓	\$201	F1	1.6	2.0-2.0/1.0	16	10.31	48,68
	3600	208-230/460	56J	K217	5K36JN56	✓	\$202	F1	1.6	2.0-2.0/1.0	16	10.82	48,68
	1800	208-230/460	56J	K553	5K42HN4139	✓	\$397	F1	1.25	2.3-2.2/1.1	18	10.41	48
3/4	3600	208-230/460	56C	K218	5K37MN37	✓	\$242	F1	1.5	2.6-2.6/1.3	18	10.70	48,68
	3600	208-230/460	56J	KG219	5K37MN38	✓	\$243	F1	1.5	2.6-2.6/1.3	17	11.22	48,68,d
	1800	208-230/460	56J	K555	5K46KN4141	✓	\$467	F1	1.25	3.3-3.0/1.5	24	11.24	48
1	3600	208-230/460	56C	K220	5K38PN47	✓	\$275	F1	1.4	3.3-3.2/1.6	19	11.30	48,68
	3600	208-230/460	56J	K221	5K38PN48	✓	\$276	F1	1.4	3.3-3.2/1.6	19	11.82	48,68
	1800	208-230/460	56J	K750	5K46MN4144	✓	\$483	F1	1.15	3.6-3.8/1.9	27	11.24	48
1 1/2	3600	208-230/460	56C	K222	5K46KN2173	✓	\$335	F1	1.3	5.0-4.8/2.4	24	10.73	48,68
	3600	208-230/460	56J	K223	5K46KN2172	✓	\$336	F1	1.3	5.0-4.8/2.4	23	11.24	48,68
	1800	208-230/460	56J	K751	5K49PN4121	✓	\$533	F1	1.15	5.8-5.6/2.8	28	11.84	48
2	3600	208-230/460	56C	K224	5K49NN2180	✓	\$392	F1	1.2	6.0-6.0/3.0	27	11.33	48,68
	3600	208-230/460	56J	K225	5K49NN2178	✓	\$392	F1	1.2	6.0-6.0/3.0	27	11.84	48,68
3	3600	208-230/460	56C	K226	5K48TN2182	✓	\$440	F1	1.15	8.9-8.2/4.1	38	12.61	48,68
	3600	208-230/460	56J	K227	5K48TN2181	✓	\$443	F1	1.15	8.9-8.2/4.1	38	13.12	48,68
	3600	115/230	56J	C1092	5KCR39UN2505X	✓	\$458	F1	1.2	19.2/9.6	23	13.98	1
	3600	115/230	56J	C1466	5KCR39UN2892X	✓	\$463	F1	1.2	19.2/9.6	23	13.98	1

Additional Features:

- Drip cover is included



### C-Face Footed (Rigid Base), 56J

C-Face Footed (Rigid Base)

HP	RPM	VOLTS	FRAME	CAT. NO.	MODEL NO.	STOCK	LIST PRICE	MULT. SYMB.	SERVICE FACTOR	F.L. AMPS	WEIGHT	"C" DIM.	FOOT NOTES
1/3	3600	208-230/460	56J	J047	056T34D5368		\$183	F1	1.75	1.2-1.1/1.55	21	10.43	68
1/2	3600	208-230/460	56J	J048	056T34D5367	✓	\$206	F1	1.6	2.1-2.2/1.1	21	10.93	68
3/4	3600	208-230/460	56J	J049	056T34D5365	✓	\$247	F1	1.5	2.6-2.6/1.3	22	11.22	68
1	3600	208-230/460	56J	J050	056T34D5366	✓	\$281	F1	1.4	3.7-3.7/1.85	23	10.93	68
1 1/2	3600	208-230/460	56J	J051	056T34D5369	✓	\$341	F1	1.15	5.0-4.8/2.4	23	11.24	68
2	3600	208-230/460	56J	J052	056T34D5370	✓	\$399	F1	1.2	6.4-6.2/3.1	30	10.93	68
3	3600	208-230/460	56J	J053	056T34D5371	✓	\$447	F1	1.15	8.9-8.4/4.2	32	11.93	68

# Centrifugal Pump (Jet Pump)

## Three Phase, Totally Enclosed



### Features:

- Service Factor, as noted
- Double sealed ball bearings, mechanically locked on shaft end
- Continuous Duty
- Nameplated 60/50 hertz, 190/380 volts at next lower HP, as noted
- 56C = carbon steel shaft with key, drip cover not included, see Accessories Section
- 56J = 416 stainless steel threaded shaft with slinger
- UL Recognized, CSA Certified, and CE Mark

### C-Face Footless, 56C/56J

HP	RPM	VOLTS	FRAME	CAT. NO.	MODEL NO.	STOCK	LIST PRICE	MULT. SYMB.	SERVICE FACTOR	F.L. AMPS	WEIGHT	"C" DIM.	FOOT NOTES
1/3	3600	208-230/460	56C	P101	056T34T5306	✓	\$205	F1	1.35	1.7-2.0/1.0	18	9.94	N,68
1/2	3600	208-230/460	56C	P102	056T34F5321	✓	\$228	F1	1.15	2.1-2.2/1.1	21	11.82	12,18
	3600	200-230/460	56J	K230	5K35JN47	✓	\$331	F1	1.6	2.1-2.0/1.0	17	11.40	18,82
3/4	1800	208-230/460	56J	K550	5K42HN4133	✓	\$402	F1	1.0	2.3-2.2/1.1	22	11.52	48
	3600	208-230/460	56C	P103	056T34F5322	✓	\$270	F1	1.15	3.0-3.2/1.6	22	11.82	68
1	3600	208-230/460	56J	KG232	5K36MN339	✓	\$366	F1	1.5	2.6-2.6/1.3	16	11.90	48,d
	3600	208-230/460	56C	P104	056T34F5323	✓	\$303	F1	1.15	3.7-3.7/1.85	24	11.82	68
1 1/2	3600	200-230/460	56J	KG234	5K38RN49	✓	\$420	F1	1.4	3.2-3.0/1.5	25	12.90	48,d
	3600	208-230/460	56C	P105	056T34F5324	✓	\$352	F1	1.15	4.6/2.3	25	11.82	68
2	3600	200-230/460	56J	KG236	5K49PN2330	✓	\$452	F1	1.3	4.8-4.2/2.1	31	12.95	48
	3600	208-230/460	56C	P106	056T34F5325	✓	\$408	F1	1.15	6.0-6.0/3.0	29	12.32	68
3	3600	200-230/460	56J	K238	5K49SN2184	✓	\$513	F1	1.2	5.8-5.4/2.7	35	13.48	48
	3600	208-230/460	56C	P107	056T34F5326	✓	\$443	F1	1.15	8.4-7.6/3.8	38	13.32	68
	3600	230/460	56J	K240	5K49ZN2190	✓	\$621	F1	1.0	8.0/4.0	49	14.79	48

### Additional Features:

- Drip cover included



### C-Face Footed (Removable Base), 56J

HP	RPM	VOLTS	FRAME	CAT. NO.	MODEL NO.	STOCK	LIST PRICE	MULT. SYMB.	SERVICE FACTOR	F.L. AMPS	WEIGHT	"C" DIM.	FOOT NOTES
1/3	3600	208-230/460	56J	J060	056T34T5308		\$225	F1	1.15	1.7-2.0/1.0	21	10.44	N,68
1/2	3600	208-230/460	56J	J061	056T34F5342	✓	\$247	F1	1.15	2.1-2.2/1.1	23	12.32	68
3/4	3600	208-230/460	56J	J062	056T34F5343	✓	\$290	F1	1.15	3.0-3.2/1.6	23	12.32	68
1	3600	208-230/460	56J	J063	056T34F5344	✓	\$323	F1	1.15	3.7-3.7/1.85	25	12.32	68
1 1/2	3600	208-230/460	56J	J064	056T34F5345	✓	\$388	F1	1.15	4.7-4.6/2.3	26	12.32	68
2	3600	208-230/460	56J	J065	056T34F5346	✓	\$445	F1	1.15	6.0-6.0/3.0	30	12.82	68
3	3600	208-230/460	56J	J066	056T34F5347	✓	\$507	F1	1.15	8.4-7.6/3.8	40	13.82	68

PUMP MOTORS (FLUID HANDLING)

# Close-Coupled Pump, JM

## Single Phase, Dripproof

### Applications:

Close-coupled pumps where the pump impeller is mounted directly on the motor shaft in environments that are relatively clean and dry.

### Features:

- NEMA JM pump shaft dimensions
- Ball bearings, mechanically locked on shaft end
- Capacitor start design for high starting torque
- Capacitor start / capacitor run design for higher efficiency, as noted
- Continuous duty
- 1.15 Service Factor
- UL Recognized and CSA Certified



### C-Face Footed (Rigid Base)

HP	RPM	VOLTS	FRAME	CAT. NO.	MODEL NO.	STOCK	LIST PRICE	MULT. SYMB.	NOM. EFF.	F.L. AMPS	WEIGHT	"C" DIM.	FOOT NOTES
1	1800	115/208-230	143JM	Z401	143TCDR5328		\$427	S2	72.0	13.4/6.8-6.7	34	13.62	68
1 1/2	1800	115/208-230	145JM	Z403	145TCDR5328		\$475	S2	77.0	18.0/9.3-9.0	43	14.62	68
2	3600	115/208-230	145JM	Z404	145TBDR5304		\$478	S2	78.5	19.2/10.5-9.6	36	13.62	1
	1800	115/230	182JM	Z405A	182TCDW7074	✓	\$545	S2	72.0	23.0/11.5	69	16.09	13
3	3600	115/230	182JM	Z406A	182TCDW7318	✓	\$605	S2	75.5	32.0/16.1	60	15.32	13
	1800	115/230	184JM	Z407A	184TCDR7047	✓	\$707	S2	75.5	33.0/16.5	77	17.59	13
5	3600	230	184JM	Z408A	184TBDW17007	✓	\$886	S2	80.0	22.0	93	16.32	1,13
	1800	230	213JM	Z409	213TCDW7027	✓	\$972	S2	78.5	28.0	115	19.92	
7 1/2	3600	230	213JM	Z410	213TCDW7002	✓	\$1,106	S2	78.5	37.0	106	18.42	
	1800	230	215JM	Z411	215TBDW7029	✓	\$1,343	S2	84.0	34.5	120	19.92	1
10	3600	230	215JM	Z412	215TCDW7002	✓	\$1,423	S2	81.5	47.0	150	19.92	
	1800	230	215JM	Z413	215TBDW7027	✓	\$1,628	S2	82.5	44.0	159	21.17	1

# Close-Coupled Pump, JM

## Single Phase, Totally Enclosed

### Applications:

Close-coupled pumps where the pump impeller is mounted directly on the motor shaft in damp, dusty, or dirty environments.

### Features:

- NEMA JM pump shaft dimensions
- Ball bearings, mechanically locked on shaft end
- Capacitor start/capacitor run design for higher efficiency
- Continuous duty
- 1.0 Service Factor (except as noted)
- UL Recognized and CSA Certified



### C-Face Footed (Rigid Base)

HP	RPM	VOLTS	FRAME	CAT. NO.	MODEL NO.	STOCK	LIST PRICE	MULT. SYMB.	NOM. EFF.	F.L. AMPS	WEIGHT	"C" DIM.	FOOT NOTES
5	3600	230	184JM	Z433A	184TBFW7315	✓	\$917	S2	82.5	19.2	89	18.59	13
7 1/2	3600	230	213JM	Z434	213TBFW7010	✓	\$1,231	S2	81.5	32.0	90	20.59	68
10	3600	230	215JM	Z435	215TBFW7010	✓	\$1,500	S2	85.5	41.5	236	22.09	18

# Close-Coupled Pump, JM, Three Phase

## Dripproof, C-Face Footless (Vertical) and C-Face Footed (Rigid Base)

### Applications:

Close-coupled pumps where the pump impeller is mounted directly on the motor shaft in environments that are relatively clean and dry.

### Features:

- NEMA JM pump shaft dimensions
- JMV frame includes drip cover for vertical mount without base
- JM frame has rigid base, drip cover not included
- Ball bearings, mechanically locked on shaft end
- Continuous duty
- 1.15 Service Factor
- UL Recognized and CSA Certified
- UL Listed for Fire Pump applications (except as noted)



Suitable for use on VFD per guidelines on page 17.

HP	RPM	VOLTS	FRAME	CAT. NO.	MODEL NO.	STOCK	LIST PRICE	MULT. SYMB.	NOM. EFF.	F.L. AMPS	WEIGHT	"C" DIM.	FOOT NOTES
1	1800	200	143JM	<b>E115</b>	143TTDR4040		\$354	S2	82.5	3.6	41	14.62	
	1800	200	143JMV	<b>E117</b>	143TTDR4041		\$395	S2	82.5	3.6	40	14.92	27
	1800	230/460	143JM	<b>E100</b>	143TTDR4035	✓	\$354	S2	82.5	3.1/1.55	44	14.62	68
	1800	230/460	143JMV	<b>E118</b>	143TTDR4034	✓	\$395	S2	82.5	3.1/1.55	40	14.92	27,68
	1800	575	143JM	<b>E116</b>	143TTDR4047		\$354	S2	82.5	1.1	36	14.62	
	1800	575	143JMV	<b>E119</b>	143TTDR4046		\$395	S2	82.5	1.1	40	14.92	27
1 1/2	3600	200	143JM	<b>E120</b>	143TTDR4016		\$404	S2	82.5	5.5	32	13.12	1,13
	3600	200	143JMV	<b>E122</b>	143TTDR4017		\$445	S2	82.5	5.5	32	12.92	27
	3600	230/460	143JM	<b>E123</b>	143TTDR4009	✓	\$404	S2	82.5	4.8/2.4	28	13.12	68
	3600	208-230/460	143JMV	<b>E095</b>	143TTDR14004		\$445	S2	82.5	5.2-5.0/2.5	42	12.92	27,68
	3600	575	143JM	<b>E121</b>	143TTDR4022		\$404	S2	82.5	1.9	28	13.12	
	3600	575	143JMV	<b>E124</b>	143TTDR4024		\$445	S2	82.5	1.9	36	12.92	27
	1800	200	145JM	<b>E125</b>	145TTDR4040		\$386	S2	84.0	5.0	41	14.62	
	1800	200	145JMV	<b>E127</b>	145TTDR4041		\$429	S2	84.0	5.0	39	14.92	27
	1800	230/460	145JM	<b>E102</b>	145TTDR4034	✓	\$386	S2	84.0	4.4/2.2	44	14.62	68
	1800	230/460	145JMV	<b>E128</b>	145TTDR4035	✓	\$429	S2	84.0	4.4/2.2	39	14.92	27,68
	1800	575	145JM	<b>E126</b>	145TTDR4072		\$386	S2	84.0	1.8	41	14.62	
	1800	575	145JMV	<b>E129</b>	145TTDR4047		\$429	S2	84.0	1.8	40	14.92	27
2	3600	200	145JM	<b>E130</b>	145TTDR4015		\$454	S2	84.0	6.2	43	13.12	
	3600	200	145JMV	<b>E132</b>	145TTDR4016		\$496	S2	84.0	6.2	32	13.42	27
	3600	208-230/460	145JM	<b>E096</b>	145TTDR4317	✓	\$454	S2	84.0	5.6-5.4/2.7	33	13.12	68
	3600	230/460	145JMV	<b>E133</b>	145TTDR4010	✓	\$496	S2	84.0	5.4/2.7	44	13.42	27,68,d
	3600	575	145JM	<b>E131</b>	145TTDR4021		\$454	S2	84.0	2.2	32	13.12	
	3600	575	145JMV	<b>E134</b>	145TTDR4022		\$496	S2	84.0	2.2	32	13.42	27
	1800	200	145JM	<b>E135</b>	145TTDR4066		\$404	S2	84.0	6.7	45	15.12	
	1800	200	145JMV	<b>E137</b>	145TTDR4067		\$445	S2	84.0	6.7	42	15.42	27
	1800	230/460	145JM	<b>E104</b>	145TTDR4060	✓	\$404	S2	84.0	5.8/2.9	48	15.12	68
	1800	230/460	145JMV	<b>E138</b>	145TTDR4051	✓	\$445	S2	84.0	5.8/2.9	44	15.42	27,68
	1800	575	145JM	<b>E136</b>	145TTDR4046		\$404	S2	84.0	2.3	45	15.12	
	1800	575	145JMV	<b>E139</b>	145TTDR4073		\$445	S2	84.0	2.3	43	15.42	27

Catalog numbers (Cat No.) highlighted in bold blue have efficiency levels that meet EISA requirements

Continued on next page.

# Close-Coupled Pump, JM, Three Phase

## Drip-proof, C-Face Footless (Vertical) and C-Face Footed (Rigid Base)

HP	RPM	VOLTS	FRAME	CAT. NO.	MODEL NO.	STOCK	LIST PRICE	MULT. SYMB.	NOM. EFF.	F.L. AMPS	WEIGHT	"C" DIM.	FOOT NOTES	
3	3600	200	145JM	<b>E140</b>	145TTDR4115		\$507	S2	84.0	10	34	13.62		
	3600	200	145JMV	<b>E142</b>	145TTDR4307		\$549	S2	84.0	10	34	13.92	27	
	3600	208-230/460	145JM	<b>M311</b>	145TTDR5315	√	\$406	S2	84.0	8.9-8.4/4.2	34	13.62	68	
	3600	208-230/460	145JMV	<b>M312</b>	145TTDR5316	√	\$448	S2	84.0	8.9-8.4/4.2	33	13.92	27,68	
	3600	230/460	145JM	<b>E105</b>	145TTDR4303		\$507	S2	84.0	8.4/4.2	26	13.62	68	
	3600	230/460	145JMV	<b>E143</b>	145TTDR4110		\$549	S2	84.0	8.4/4.2	34	13.92	27,68	
	3600	575	145JM	<b>E141</b>	145TTDR4121		\$507	S2	84.0	3.5	34	13.62		
	3600	575	145JMV	<b>E144</b>	145TTDR4025		\$549	S2	84.0	3.5	33	13.92	27	
	1800	200	182JM	<b>E145</b>	182TTDR4140		\$471	S2	86.5	9.4	70	17.09		
	1800	200	182JMV	<b>E147</b>	182TTDR4036		\$555	S2	86.5	9.9	78	18.87	27	
	1800	208-230/460	182JM	<b>E097</b>	182TTDW14029	√	\$471	S2	86.5	8.8/4.4	83	14.82	13,68,98	
	1800	230/460	182JM	<b>E106A</b>	182TTDW4336	√	\$471	S2	86.5	9.0-8.8/4.4	70	14.82	13,68	
	1800	230/460	182JMV	<b>E098</b>	182TTDW4006	√	\$555	S2	85.5	9.0-8.8/4.4	64	18.78	27,68,98	
	1800	230/460	182JMV	<b>E148A</b>	182TTDW4135	√	\$555	S2	86.5	8.8/4.4	64	18.78	27,68	
	1800	575	182JM	<b>E146</b>	182TTDR4146		\$471	S2	86.5	3.45	89	16.09		
	1800	575	182JMV	<b>E149A</b>	182TTDW4147		\$555	S2	86.5	3.5	87	18.28	27	
	5	3600	200	182JM	<b>E150</b>	182TTDR4116		\$608	S2	86.5	13.8	75	16.09	13
		3600	200	182JMV	<b>E152</b>	182TTDR4117		\$690	S2	86.5	13.8	78	16.68	27
3600		208-230/460	182JM	<b>M1315</b>	182TTDB7325		\$528	S2	85.5	13.6-12.4/6.2	88	14.82	13,68,98	
3600		208-230/460	182JMV	<b>M1316</b>	182TTDB7601		\$590	S2	85.5	13.6-12.4/6.2	74	19.24	27,68,98	
3600		230/460	182JM	<b>E107A</b>	182TTDW4325	√	\$608	S2	85.5	14-12.4/6.2	87	14.82	13	
3600		230/460	182JMV	<b>E153A</b>	182TTDW4304	√	\$690	S2	85.5	12.4/6.2	78	18.78	27	
3600		575	182JM	<b>E151</b>	182TTDR4122		\$608	S2	86.5	4.8	79	16.09	13	
3600		575	182JMV	<b>E154</b>	182TTDR4123		\$690	S2	86.5	4.8	73	16.68	27	
1800		200	184JM	<b>E155</b>	184TTDR4140		\$608	S2	87.5	15.1	78	16.59		
1800		200	184JMV	<b>E157</b>	184TTDR4141		\$690	S2	87.5	14.5	78	19.37	27	
1800		208-230/460	184JM	<b>M1317</b>	184TTDW7357		\$608	S2	87.5	14.6-13.2/6.6	78	14.82	68,98,d	
1800		230/460	184JM	<b>E108</b>	184TTDR4034		\$608	S2	87.5	13.2/6.6	75	17.09	13	
1800		230/460	184JMV	<b>E158A</b>	184TTDW4135	√	\$690	S2	87.5	13.2/6.6	78	15.72	27,68	
1800		575	184JM	<b>E156</b>	184TTDR4146		\$608	S2	87.5	5.3	89	17.59	13	
1800		575	184JMV	<b>E159</b>	184TTDR4147		\$690	S2	87.5	5.2	83	19.37	27	
7 1/2		3600	200	184JM	<b>E160</b>	184TTDR4115		\$731	S2	87.5	20.2	87	17.09	13
		3600	200	184JMV	<b>E162</b>	184TTDR4116		\$815	S2	87.5	20.2	89	19.87	27
		3600	230/460	184JM	<b>E109A</b>	184TTDW14001	√	\$731	S2	87.5	17.6/8.8	89	15.82	13,68,98
	3600	230/460	184JMV	<b>E163A</b>	184TTDW4005	√	\$815	S2	87.5	17.6/8.8	90	15.82	27,68,98	
	3600	575	184JM	<b>E161</b>	184TTDR4121		\$731	S2	87.5	7.2	90	17.09	13	
	3600	575	184JMV	<b>E164</b>	184TTDR4122		\$815	S2	87.5	7.2	98	17.68	27	

Catalog numbers (Cat No.) highlighted in bold blue have efficiency levels that meet EISA requirements

Continued on next page.



# Close-Coupled Pump, JM, Three Phase

## Drip-proof, C-Face Footless (Vertical) and C-Face Footed (Rigid Base)

HP	RPM	VOLTS	FRAME	CAT. NO.	MODEL NO.	STOCK	LIST PRICE	MULT. SYMB.	NOM. EFF.	F.L. AMPS	WEIGHT	"C" DIM.	FOOT NOTES
7 1/2	1800	200	213JM	<b>E165</b>	213TTDW4042		\$686	S2	88.5	22.1	118	19.16	
	1800	200	213JMV	<b>E167</b>	213TTDW4033		\$772	S2	88.5	22.1	96	20.44	27
	1800	208-230/460	213JMV	M1322	213TTDBA7048	✓	\$815	S2	84.0	22.0-21.6/10.8	68	18.94	d,27,68,98
	1800	230/460	213JM	<b>E110</b>	213TTDW4047	✓	\$879	S2	88.5	19.2/9.6	100	19.16	68
	1800	230/460	213JMV	<b>E168</b>	213TTDW4048	✓	\$772	S2	88.5	19.2/9.6	121	20.44	27,68
	1800	575	213JM	<b>E166</b>	213TTDW4041		\$686	S2	88.5	7.6	120	19.16	
	1800	575	213JMV	<b>E169</b>	213TTDW4038		\$990	S2	88.5	7.7	142	20.44	27
10	3600	200	213JM	<b>E170</b>	213TTDW4009		\$940	S2	88.5	26.9	131	19.16	
	3600	200	213JMV	<b>E172</b>	213TTDW4008		\$1,049	S2	88.5	26.9	112	20.44	27
	3600	230/460	213JM	<b>E111</b>	213TTDW4022	✓	\$940	S2	88.5	23.4/11.7	135	19.16	68
	3600	230/460	213JMV	<b>E173</b>	213TTDW4023	✓	\$1,049	S2	88.5	23.4/11.7	132	20.44	27
	3600	575	213JM	<b>E171</b>	213TTDW4010		\$940	S2	88.5	9.3	153	19.16	
	3600	575	213JMV	<b>E174</b>	213TTDW4007		\$1,049	S2	88.5	9.3	125	20.44	27
	1800	200	215JM	<b>E175</b>	215TTDW4041		\$1,043	S2	89.5	28.7	124	19.16	68,98
	1800	200	215JMV	<b>E177</b>	215TTDW4043		\$1,152	S2	89.5	28.7	128	20.44	27,68
	1800	208-230/460	215JMV	M326	215TTDW7048	✓	\$945	S2	87.5	29.2-26.4/13.2	132	20.44	d,27,68
	1800	230/460	215JM	<b>E112</b>	215TTDW4047	✓	\$1,043	S2	89.5	25.0/12.5	135	19.16	68
	1800	230/460	215JMV	<b>E178</b>	215TTDW4048	✓	\$1,152	S2	89.5	25.0/12.5	135	20.44	27
	1800	575	215JM	<b>E176</b>	215TTDW4042		\$1,043	S2	89.5	10.0	125	19.16	13
	1800	575	215JMV	<b>E179</b>	215TTDW4032		\$1,152	S2	89.5	10.0	118	20.44	27
	15	3600	200	215JM	<b>E180</b>	215TTDW4008		\$1,161	S2	90.2	39.0	128	20.41
3600		200	215JMV	<b>E182</b>	215TTDW4010		\$1,272	S2	90.2	39.0	160	21.69	27
3600		230/460	215JM	<b>E113</b>	215TTDW4022	✓	\$1,161	S2	90.2	34.0/17.0	131	20.41	13
3600		230/460	215JMV	<b>E183</b>	215TTDW4023	✓	\$1,272	S2	90.2	34.0/17.0	127	21.69	27,68
3600		575	215JM	<b>E181</b>	215TTDW4009		\$1,161	S2	90.2	13.6	159	20.41	13
3600		575	215JMV	<b>E184</b>	215TTDW4007		\$1,272	S2	90.2	13.6	127	21.69	27
1800		200	254JM	<b>E185</b>	254TTDX4343		\$1,410	S2	91.0	44.0	268	24.17	13
1800		200	254JMV	<b>E187</b>	254TTDX4345		\$1,571	S2	91.0	44.2	263	25.45	27
1800		208-230/460	254JM	<b>E114A</b>	254TTDX14062	✓	\$1,410	S2	91.0	115/208-230	248	24.17	68
1800		230/460	254JMV	<b>E188</b>	254TTDX4039	✓	\$1,571	S2	91.0	38.5/19.2	220	25.45	27,68
1800		575	254JM	<b>E186</b>	254TTDX4344		\$1,043	S2	91.0	15.3	200	24.17	27
20	3600	200	254JM	<b>E190</b>	254TTDX4007		\$1,161	S2	91.0	53.1	204	24.17	
	3600	200	254JMV	<b>E193</b>	254TTDX4015		\$1,625	S2	91.0	53.1	185	23.70	27
	3600	230/460	254JM	<b>E191</b>	254TTDX4006	✓	\$1,465	S2	91.0	46.0/23.1	213	22.42	
	3600	230/460	254JMV	<b>E194</b>	254TTDX4020		\$1,625	S2	91.0	46.0/23.1	187	23.70	27,68
	3600	575	254JM	<b>E192</b>	254TTDX4019		\$1,465	S2	91.0	18.5	225	22.42	
	3600	575	254JMV	<b>E195</b>	254TTDX4024		\$1,625	S2	91.0	18.5	178	23.70	27

Catalog numbers (Cat No.) highlighted in bold blue have efficiency levels that meet EISA requirements

Continued on next page.

# Close-Coupled Pump, JM, Three Phase

Dripproof, C-Face Footless (Vertical) and C-Face Footed (Rigid Base)

HP	RPM	VOLTS	FRAME	CAT. NO.	MODEL NO.	STOCK	LIST PRICE	MULT. SYMB.	NOM. EFF.	F.L. AMPS	WEIGHT	"C" DIM.	FOOT NOTES
20	1800	200	256JMV	<b>E199</b>	256TTDX4329		\$1,860	S2	91.0	60.0	235	25.45	27
	1800	230/460	256JM	<b>E197</b>	256TTDX4075	√	\$1,702	S2	91.0	52.0/26	128	24.17	68
	1800	230/460	256JMV	<b>U100</b>	256TTDX4041		\$1,860	S2	91.0	50.0/25	196	25.45	27,68
	1800	575	256JM	<b>E198</b>	256TTDX4326		\$1,702	S2	91.0	20.8	238	24.17	
	1800	575	256JMV	<b>U101</b>	256TTDX4047		\$1,860	S2	91.0	20.8	188	25.45	27
25	3600	200	256JM	<b>U102</b>	256TTDX4021		\$1,723	S2	91.0	66.5	225	24.17	
	3600	230/460	256JM	<b>U103</b>	256TTDX4006	√	\$1,723	S2	91.0	58.0/29	126	24.17	68
	3600	575	256JM	<b>U104</b>	256TTDX4019		\$1,723	S2	91.0	23.2	196	24.17	
25	1800	208	284JM	<b>U105</b>	284TTDP4043		\$2,058	S2	91.7	67.5	358	24.31	
	1800	230/460	284JM	<b>U106</b>	284TTDP4069	√	\$2,058	S2	91.7	61.0/30.5	360	24.31	68
	1800	575	284JM	<b>U107</b>	284TTDP4037		\$2,058	S2	91.0	24.5	360	24.31	68
30	3600	200	284JM	<b>U108</b>	284TTDP4025		\$2,101	S2	91.0	83.0	295	24.31	
	3600	230/460	284JM	<b>U109A</b>	284TTDP14009	√	\$2,101	S2	91.0	72./36.0	346	24.31	
	3600	575	284JM	<b>U110</b>	284TTDP4023		\$2,101	S2	91.0	28.8	315	24.31	
	1800	200	286JM	<b>U111</b>	286TTDP4067		\$2,377	S2	92.4	83.0	410	25.81	
	1800	230/460	286JM	<b>U112</b>	286TTDP4037		\$2,377	S2	92.4	72.0/36.0	385	25.81	68
	1800	575	286JM	<b>U113</b>	286TTDP4047		\$2,377	S2	92.4	28.8	385	25.81	d,68
40	3600	230/460	286JM	<b>U114</b>	286TTDP4015	√	\$2,629	S2	91.7	94.0/47.0	575	25.81	
	3600	575	286JM	<b>U115</b>	286TTDP4021		\$2,629	S2	91.7	38.0	386	25.81	
	1800	230/460	324JM	<b>U116</b>	324TTDP4345		\$3,106	S2	93.0	97.0/48.5	340	26.25	68
50	3600	230/460	324JM	<b>U118</b>	324TTDP4004	√	\$3,364	S2	92.4	117/58.5	460	26.25	
	3600	575	324JM	<b>U119</b>	324TTDP4018		\$3,364	S2	92.4	47.0	460	26.25	
	1800	230/460	326JM	<b>U120</b>	326TTDP4329		\$3,587	S2	93.0	123/61.5	525	27.75	68
	1800	575	326JM	<b>U121</b>	326TTDP4326		\$3,587	S2	93.0	47.5	525	27.75	

Catalog numbers (Cat No.) highlighted in bold blue have efficiency levels that meet EISA requirements

Blue shaded areas are Cast Iron Frames

# Globetrotter® NEMA Premium® Efficiency Close Coupled Pump, JM, Three Phase

Dripproof, C-Face Footed (Rigid Base)

## Features:

### ⚡ Meets or exceeds NEMA Premium® efficiencies

NEMA Premium® models are in compliance with EISA2007

- Inverter Duty 10:1 Variable Torque and 2:1 Constant Torque, 1.0 SF
- Nameplated 60/50 hertz, 190/380 volts at next lower HP
- 1.15 Service Factor
- Class F Insulation
- Standard assembly F1, reversible to F2 assembly
- UL Recognized, CSA Certified, CE Mark
- Three year warranty



HP	RPM	VOLTS	FRAME	CAT. NO.	MODEL NO.	STOCK	LIST PRICE	MULT. SYMB.	NOM. EFF.	F.L. AMPS	WEIGHT	"C" DIM.	FOOT NOTES
1	1800	200	143JM	<b>GT2001</b>	143TTDR16043	✓	\$415	S2	85.5	3.8	41	14.62	
	1800	200	143JMV	<b>GT4001</b>	143TTDR16042	✓	\$415	S2	85.5	3.8	41	14.62	
	1800	230/460	143JM	<b>GT0401</b>	143TTDR6030	✓	\$415	S2	85.5	2.5-3.2/1.6	41	14.62	
	1800	230/460	143JMV	<b>GT4101</b>	143TTDR16047	✓	\$415	S2	85.5	3.2/1.6	41	14.62	
	1800	575	143JM	<b>GT0501</b>	143TTDR6031	✓	\$415	S2	85.5	1.2	41	14.62	
	1800	575	143JMV	<b>GT4201</b>	143TTDR16039	✓	\$415	S2	85.5	1.2	41	14.62	
1 1/2	3600	200	143JM	<b>GT2003</b>	143TTDR16009	✓	\$474	S2	84.0	4.4	40	13.12	
	3600	200	143JMV	<b>GT4003</b>	143TTDR16012	✓	\$474	S2	84.0	4.4	40	13.12	
	3600	230/460	143JM	<b>GT0403</b>	143TTDR6007	✓	\$474	S2	84.0	4.4-4.0/2.0	40	13.12	
	3600	230/460	143JMV	<b>GT4103</b>	143TTDR16013	✓	\$474	S2	84.0	4.0/2.0	40	13.12	
	3600	575	143JM	<b>GT0503</b>	143TTDR6008	✓	\$474	S2	84.0	1.7	40	13.12	
	3600	575	143JMV	<b>GT4203</b>	143TTDR16007	✓	\$474	S2	84.0	1.7	40	13.12	
	1800	200	145JM	<b>GT2004</b>	145TTDR16074	✓	\$452	S2	86.5	5.6	44	14.62	
	1800	200	145JMV	<b>GT4004</b>	145TTDR16073	✓	\$452	S2	86.5	5.6	44	14.62	
	1800	230/460	145JM	<b>GT0404</b>	145TTDR6034	✓	\$452	S2	86.5	4.8-5.6/2.4	44	14.62	
	1800	230/460	145JMV	<b>GT4104</b>	145TTDR16329	✓	\$452	S2	86.5	4.8/2.4	44	14.62	
	1800	575	145JM	<b>GT0504</b>	145TTDR6031	✓	\$452	S2	86.5	1.8	44	14.62	
	1800	575	143JMV	<b>GT4204</b>	143TTDR16046	✓	\$452	S2	86.5	1.8	44	14.62	
2	3600	200	145JM	<b>GT2006</b>	145TTDR16015	✓	\$532	S2	85.5	5.2	43	13.12	
	3600	200	145JMV	<b>GT4006</b>	145TTDR16013	✓	\$532	S2	85.5	5.2	43	13.12	
	3600	230/460	145JM	<b>GT0406</b>	145TTDR6007	✓	\$532	S2	85.5	5.2-4.8/2.4	43	13.12	
	3600	230/460	145JMV	<b>GT4106</b>	145TTDR16019	✓	\$532	S2	85.5	4.8/2.4	43	13.12	
	3600	575	145JM	<b>GT0506</b>	145TTDR6004	✓	\$532	S2	85.5	2.0	43	13.12	
	3600	575	145JMV	<b>GT4206</b>	145TTDR16018	✓	\$532	S2	85.5	2.0	43	13.12	
	1800	200	145JM	<b>GT2007</b>	145TTDR16335	✓	\$512	S2	86.5	6.0	45	15.12	
	1800	200	145JMV	<b>GT4007</b>	145TTDR16336	✓	\$512	S2	86.5	6.0	45	15.12	
	3600	575	145JM	<b>GT0506</b>	145TTDR6004	✓	\$532	S2	85.5	2.0	43	13.12	
	1800	230/460	145JMV	<b>GT4107</b>	145TTDR16332	✓	\$512	S2	86.5	5.8/2.9	45	15.12	
	1800	575	145JM	<b>GT0507</b>	145TTDR6030	✓	\$512	S2	86.5	2.5	45	15.12	
	1800	575	145JMV	<b>GT4207</b>	145TTDR16338	✓	\$512	S2	86.5	2.5	45	15.12	

Catalog numbers (Cat No.) highlighted in bold blue have efficiency levels that meet EISA requirements

PUMP MOTORS (FLUID HANDLING)

Continued on next page.

# Globetrotter® NEMA Premium® Efficiency, Close Coupled Pump, JM, Three Phase

Dripproof, C-Face Footed (Rigid Base)

HP	RPM	VOLTS	FRAME	CAT. NO.	MODEL NO.	STOCK	LIST PRICE	MULT. SYMB.	NOM. EFF.	F.L. AMPS	WEIGHT	"C" DIM.	FOOT NOTES
3	3600	200	145JM	<b>GT2009</b>	145TTDR16023	✓	\$595	S2	86.5	8.0	47	13.62	
	3600	200	145JMV	<b>GT4009</b>	145TTDR16022	✓	\$595	S2	86.5	8.0	47	13.62	
	3600	230/460	145JM	<b>GT0409</b>	145TTDR6013	✓	\$595	S2	86.5	8.0-7.2/3.6	47	13.62	
	3600	230/460	145JMV	<b>GT4109</b>	145TTDR16305	✓	\$595	S2	86.5	7.2/3.6	47	13.62	
	3600	575	145JM	<b>GT0509</b>	145TTDR6006	✓	\$595	S2	86.5	2.8	47	13.62	
	3600	575	145JMV	<b>GT4209</b>	145TTDR16302	✓	\$595	S2	86.5	2.8	47	13.62	
	1800	208-230/460	182JM	<b>GT0410</b>	182TTDB6032	✓	\$566	S2	89.5	8.4-7.8/3.9	123	15.35	
	1800	575	182JM	<b>GT0510</b>	182TTDB6033	✓	\$566	S2	89.5	3.1	123	15.35	
5	3600	208-230/460	182JM	<b>GT0412</b>	182TTDB6007	✓	\$715	S2	86.5	13.2-11.8/5.9	131	15.35	
	3600	575	182JM	<b>GT0512</b>	182TTDB6008	✓	\$715	S2	86.5	4.7	131	15.35	
	1800	208-230/460	184JM	<b>GT0413</b>	184TTDB6032	✓	\$687	S2	89.5	13.6-12.4/6.2	135	16.34	
	1800	575	184JM	<b>GT0513</b>	184TTDB6033	✓	\$687	S2	89.5	5.0	135	16.34	
7 1/2	3600	208-230/460	184JM	<b>GT0415</b>	184TTDB6007	✓	\$858	S2	88.5	19.0-17.2/8.6	149	16.34	A
	3600	575	184JM	<b>GT0515</b>	184TTDB6008	✓	\$858	S2	88.5	6.9	149	16.34	
	1800	208-230/460	213JM	<b>GT0416</b>	213TTDB6032	✓	\$1,047	S2	91.0	20.4-18.6/9.3	166	17.68	
	1800	575	213JM	<b>GT0516</b>	213TTDB6033	✓	\$1,047	S2	91.0	7.5	166	17.68	
10	3600	208-230/460	213JM	<b>GT0418</b>	213TTDB6007	✓	\$1,106	S2	89.5	25.5-23/11.5	156	17.68	
	3600	575	213JM	<b>GT0518</b>	213TTDB6008	✓	\$1,106	S2	89.5	9.2	156	17.68	
	1800	208-230/460	215JM	<b>GT0419</b>	215TTDB6032	✓	\$1,225	S2	91.7	26.9-24.4/12.2	229	19.17	
	1800	575	215JM	<b>GT0519</b>	215TTDB6033	✓	\$1,225	S2	91.7	9.8	229	19.17	
15	3600	208-230/460	215JM	<b>GT0421</b>	215TTDB6007	✓	\$1,366	S2	90.2	38.0-34.0/17.0	191	19.17	
	3600	575	215JM	<b>GT0521</b>	215TTDB6008	✓	\$1,366	S2	90.2	13.6	191	19.17	
20	1800	208-230/460	254JM	<b>GT0422</b>	254TTDCA6032	✓	\$1,646	S2	93.0	38.0/19.0	322	24.41	
	1800	575	254JM	<b>GT0522</b>	254TTDCA6033	✓	\$1,646	S2	93.0	15.2	322	24.41	
	3600	208-230/460	254JM	<b>GT0424</b>	254TTDCA6007	✓	\$1,705	S2	91.0	51.0-46.0/23.0	312	24.41	
	3600	575	254JM	<b>GT0524</b>	254TTDCA6008	✓	\$1,705	S2	91.0	18.4	312	24.41	
25	1800	208-230/460	256JM	<b>GT0425</b>	256TTDCA6032	✓	\$2,021	S2	93.0	53.0-49.0/24.5	374	26.00	
	1800	575	256JM	<b>GT0525</b>	256TTDCA6033	✓	\$2,021	S2	93.0	19.6	374	26.00	
	3600	208-230/460	256JM	<b>GT0427</b>	256TTDCA6007	✓	\$2,062	S2	91.7	64.0-57.0/28.5	328	26.00	
	3600	575	256JM	<b>GT0527</b>	256TTDCA6008	✓	\$2,062	S2	91.7	22.8	328	26.00	
30	1800	208-230/460	284JM	<b>GT0428</b>	284TTDCA6032	✓	\$2,412	S2	93.6	66.0-62.0/31.0	441	26.58	
	1800	575	284JM	<b>GT0528</b>	284TTDCA6033	✓	\$2,412	S2	93.6	24.8	441	26.58	
	3600	208-230/460	284JM	<b>GT0430</b>	284TTDCA6007	✓	\$2,462	S2	91.7	76.0-68.0/34.0	412	26.58	
	3600	575	284JM	<b>GT0530</b>	284TTDCA6008	✓	\$2,462	S2	91.7	27.2	412	26.58	
40	1800	208-230/460	286JM	<b>GT0431</b>	286TTDCA6032	✓	\$2,786	S2	94.1	81.0-74.0/37.0	502	27.10	
	1800	575	286JM	<b>GT0531</b>	286TTDCA6033	✓	\$2,786	S2	94.1	29.6	502	27.10	
	3600	208-230/460	286JM	<b>GT0433</b>	286TTDCA6007	✓	\$3,082	S2	92.4	100-90.0/45.0	470	27.10	
	3600	575	286JM	<b>GT0533</b>	286TTDCA6008	✓	\$3,082	S2	92.4	36.0	470	27.10	
50	1800	208-230/460	324JM	<b>GT0434</b>	324TTDCA6032	✓	\$3,640	S2	94.1	105-95.0/47.5	604	28.95	
	1800	575	324JM	<b>GT0534</b>	324TTDCA6033	✓	\$3,640	S2	94.1	40.4	604	28.95	
	3600	208-230/460	324JM	<b>GT0436</b>	324TTDCA6007	✓	\$3,943	S2	93.0	124-113/56.5	570	28.95	
	3600	575	324JM	<b>GT0536</b>	324TTDCA6008	✓	\$3,943	S2	93.0	45.0	570	28.95	
1800	208-230/460	326JM	<b>GT0437</b>	326TTDCA6032	✓	\$4,205	S2	94.5	131-118/59.0	738	30.12		
	575	326JM	<b>GT0537</b>	326TTDCA6033	✓	\$4,205	S2	94.5	47.0	738	30.12		

PUMP MOTORS (FLUID HANDLING)

Catalog numbers (Cat No.) highlighted in bold blue have efficiency levels that meet EISA requirements

Blue shaded areas are Cast Iron Frames

# Close-Coupled Pump, JM

## Three Phase, Totally Enclosed

### Applications:

Close-coupled pumps where the pump impeller is mounted directly on the motor shaft in damp, dusty, or dirty environments.



### Features:

- NEMA JM pump shaft dimensions
- Ball bearings, mechanically locked on shaft end
- Continuous duty
- 1.15 Service Factor (except as noted)
- UL Recognized and CSA Certified

### C- Face Footed (Rigid Base)

Suitable for use on VFD per guidelines on page 17.

HP	RPM	VOLTS	FRAME	CAT. NO.	MODEL NO.	STOCK	LIST PRICE	MULT. SYMB.	NOM. EFF.	F.L. AMPS	WEIGHT	"C" DIM.	FOOT NOTES
1	1800	200	143JM	<b>U300</b>	143TTFR4040		\$439	S2	82.5	3.5	35	15.00	
	1800	230/460	143JM	<b>U301</b>	143TTFR4034	√	\$439	S2	82.5	3.0/1.5	35	15.00	
	1800	575	143JM	<b>U302</b>	143TTFR4046		\$439	S2	82.5	1.2	35	15.00	
1 1/2	3600	200	143JM	<b>U303</b>	143TTFR4015		\$516	S2	82.5	4.6	31	15.00	
	3600	208-230/460	143JM	<b>U304A</b>	143TTFR4303	√	\$516	S2	82.5	4.4-4.0/2.0	31	14.50	68
	3600	575	143JM	<b>U305</b>	143TTFR4021		\$516	S2	82.5	1.6	31	15.00	
	1800	200	145JM	<b>U306</b>	145TTFR4048		\$481	S2	84.0	5.1	45	16.50	
	1800	230/460	145JM	<b>U307</b>	145TTFR4045	√	\$481	S2	84.0	4.4/2.2	46	16.50	68
	1800	575	145JM	<b>U308</b>	145TTFR4054		\$481	S2	84.0	1.8	45	16.50	
	1800	200	145JM	<b>U309</b>	145TTFR4017		\$559	S2	84.0	6.0	39	15.50	
2	3600	208-230/460	145JM	<b>U310A</b>	145TTFR14011	√	\$559	S2	84.0	5.6-5.2/2.6	39	15.50	
	3600	575	145JM	<b>U311</b>	145TTFR4023		\$559	S2	84.0	2.1	39	15.50	
	1800	200	145JM	<b>U312</b>	145TTFR4050		\$503	S2	84.0	6.4	48	16.00	
	1800	208-230/460	145JM	<b>U313A</b>	145TTFR14045	√	\$503	S2	84.0	6.6-6.2/3.1	48	16.00	
	1800	575	145JM	<b>U314</b>	145TTFR4128		\$503	S2	84.0	2.2	48	16.00	
	3600	208-230/460	145JM	<b>U363</b>	145TTFR4310	√	\$590	S2	85.5	8.4-8.0/4.0	59	15.00	68,d
	3600	200	182JM	<b>U315</b>	182TTFR4015		\$641	S2	85.5	8.5	81	17.35	
3	3600	230/460	182JM	<b>U316A</b>	182TTFW4302	√	\$641	S2	85.5	8.2-7.4/3.7	89	17.35	13
	3600	575	182JM	<b>U317</b>	182TTFR4021		\$641	S2	85.5	2.95	81	17.35	
	1800	208-230/460	182JM	<b>U319A</b>	182TTFW4330	√	\$586	S2	87.5	8-8.6/4.3	72	16.59	13
	1800	575	182JM	<b>U320</b>	182TTFR4056		\$586	S2	87.5	3.35	79	18.35	
	3600	230/460	184JM	<b>U322A</b>	184TTFW4009	√	\$761	S2	87.5	12.2/6.1	118	16.09	13
	3600	575	184JM	<b>U323</b>	184TTFR4021		\$761	S2	87.5	4.9	82	18.35	
	1800	208-230/460	184JM	<b>U325A</b>	184TTFW4760	√	\$708	S2	87.5	14.0-13.0/6.5	82	15.59	13
5	1800	575	184JM	<b>U326A</b>	184TTFW14028		\$761	S2	87.5	5.2	89	15.59	13
	3600	200	213JM	<b>U327</b>	213TTFW4009		\$949	S2	88.5	21.1	125	22.09	
	3600	208-230/460	184JM	<b>U360</b>	184TTFW4915	√	\$718	S2	88.5	17.6-16.8/8.4	127	18.09	13,17,68
	3600	230/460	213JM	<b>U329</b>	213TTFW4022	√	\$949	S2	88.5	18.4/9.2	113	22.09	68
	3600	575	213JM	<b>U331</b>	213TTFW4010		\$949	S2	88.5	7.3	147	22.09	68
	1800	230/460	213JM	<b>U334</b>	213TTFW4047	√	\$1,085	S2	89.5	20.0/10.0	131	20.59	68
	1800	575	213JM	<b>U335</b>	213TTFW4038		\$1,085	S2	89.5	8	225	20.59	68

PUMP MOTORS (FLUID HANDLING)

Catalog numbers (Cat No.) highlighted in bold blue have efficiency levels that meet EISA requirements

Continued on next page.

# Close-Coupled Pump, JM

## Three Phase, Totally Enclosed

### C-Face Footed (Rigid Base)

HP	RPM	VOLTS	FRAME	CAT. NO.	MODEL NO.	STOCK	LIST PRICE	MULT. SYMB.	NOM. EFF.	F.L. AMPS	WEIGHT	"C" DIM.	FOOT NOTES
10	3600	200	215JM	<b>U336</b>	215TTFW4014		\$1,161	S2	89.5	27.6	128	22.09	
	3600	230/460	215JM	<b>U337</b>	215TTFW4022	✓	\$1,161	S2	89.5	24.0/12.0	142	22.09	68
	3600	575	215JM	<b>U338</b>	215TTFW4015		\$1,161	S2	89.5	9.6	158	22.09	
	1800	200	215JM	<b>U339</b>	215TTFW4035		\$1,298	S2	89.5	29.9	130	22.09	
	1800	230/460	215JM	<b>U340</b>	215TTFW4047	✓	\$1,298	S2	89.5	25.6/12.8	135	22.09	
	1800	575	215JM	<b>U341</b>	215TTFW4036		\$1,298	S2	89.5	10.4	128	22.09	
15	3600	208-230/460	215JM	<b>U357</b>	215TTFW14301	✓	\$1,182	S2	90.2	39.0-36.0/18.0	151	22.09	68
	3600	230/460	254JM	<b>U344</b>	254TTFL4006	✓	\$1,451	S2	91.0	35.0/17.5	138	24.74	AL,68
	3600	575	254JM	<b>U346</b>	254TTFL4010		\$1,451	S2	90.2	14.0	563	24.74	AL
	1800	200	254JM	<b>U347</b>	254TTFL4034		\$1,760	S2	91.0	46.0	225	24.74	AL
	1800	230/460	254JM	<b>U348</b>	254TTFL4031	✓	\$1,760	S2	91.0	40.0/20.0	224	24.74	AL,68
	1800	575	254JM	<b>U349</b>	254TTFL4036		\$1,760	S2	91.0	16.0	220	24.74	AL
20	3600	200	256JM	<b>U350</b>	256TTFL4010		\$1,953	S2	90.2	54.1	232	26.49	AL
	3600	230/460	256JM	<b>U351</b>	256TTFL4006	✓	\$1,953	S2	90.2	47.0/23.5	232	26.49	AL,68
	3600	575	256JM	<b>U352</b>	256TTFL4012		\$1,953	S2	90.2	18.8	232	26.49	AL
	1800	200	256JM	<b>U353</b>	256TTFL4036		\$2,136	S2	91.0	58.7	321	28.49	AL
	1800	230/460	256JM	<b>U354</b>	256TTFL4031	✓	\$2,136	S2	91.0	51.0/25.5	321	28.49	AL,68
	1800	575	256JM	<b>U355</b>	256TTFL4038		\$2,136	S2	91.0	20.4	321	28.49	AL

# Close-Coupled Pump, JP

## Single Phase, DripProof

### Applications:

Close-coupled pumps where the pump impeller is mounted directly on the motor shaft in environments that are relatively clean and dry.

### Features:

- NEMA JP pump shaft dimensions
- Ball bearings, mechanically locked on shaft end
- Capacitor start design for high starting torque
- Capacitor start / capacitor run design for higher efficiency, as noted
- Continuous duty
- 1.15 Service Factor
- UL Recognized and CSA Certified



### C-Face Footed (Rigid Base)

HP	RPM	VOLTS	FRAME	CAT. NO.	MODEL NO.	STOCK	LIST PRICE	MULT. SYMB.	NOM. EFF.	F.L. AMPS	WEIGHT	"C" DIM.	FOOT NOTES
1	1800	115/208-230	143JP	Z420	143TCDR5330		\$395	S2	72.0	13.4/6.8-6.7	35	16.68	95
1 1/2	1800	115/208-230	145JP	Z422	145TCDR5329		\$475	S2	77.0	18.6/9.9-9.3	43	17.68	95
2	1800	115/230	182JP	Z424	182TCDR7354		\$605	S2	72.0	23.0/11.5	78	19.15	13
3	3600	115/230	182JP	Z425	182TCDR8005		\$605	S2	74.0	32.0/16.0	87	18.65	13
	1800	115/230	184JP	Z426	184TCDR7626		\$707	S2	75.5	33.0/16.5	94	20.65	13
5	3600	230	184JP	Z427A	184TBDW17011	✓	\$886	S2	80.0	22.0	89	19.46	1,13
	1800	230	213JP	Z428	213TCDW7028		\$972	S2	78.5	28.0	130	23.79	95
7 1/2	3600	230	213JP	Z429	213TCDW7003	✓	\$1,106	S2	78.5	37.0	118	22.29	95
	1800	230	215JP	Z430	215TBDW7045		\$1,343	S2	84.0	34.5	132	23.79	1,95
10	3600	230	215JP	Z431	215TCDW7004	✓	\$1,423	S2	81.5	47.0	135	23.79	95
	1800	230	215JP	Z432	215TBDW7030		\$1,628	S2	82.5	44.0	325	25.04	1,95

Catalog numbers (Cat No.) highlighted in bold blue have efficiency levels that meet EISA requirements

Continued on next page.

# Globetrotter® NEMA Premium® Efficiency Close-Coupled Pump, JM, Three Phase TEFC, C-Face Footed (Rigid Base)

## Features:

- ⚡ Meets or exceeds NEMA Premium® efficiencies NEMA Premium® models are in compliance with EISA2007
- Inverter Duty 10:1 Variable Torque and 2:1 Constant Torque, 1.0 SF
- Dual rated motors are nameplated 60/50 hertz, 190/380 volts at next lower HP
- 1.15 Service Factor
- Class F Insulation
- Standard assembly F1, reversible to F2 assembly
- UL Recognized, CSA Certified, CE Mark
- Three year warranty



HP	RPM	VOLTS	FRAME	CAT. NO.	MODEL NUMBER	STOCK	LIST PRICE	MULT. SYMB.	NOM. EFF.	F.L. AMPS	WEIGHT	"C" DIM.	FOOT NOTES
1	1800	200	143JM	<b>GT3001</b>	143TTFR16047	√	\$536	S2	85.5	3.8	59	16.00	
	1800	200	143JMV	<b>GT5001</b>	143TTFR16048	√	\$529	S2	85.5	3.8	57	16.79	
	1800	230/460	143JM	<b>GT3101</b>	143TTFR16032	√	\$536	S2	85.5	3.3/1.65	59	16.00	
	1800	230/460	143JMV	<b>GT5101</b>	143TTFR16052	√	\$529	S2	85.5	3.3/1.65	57	16.79	
	1800	575	143JM	<b>GT3201</b>	143TTFR16046	√	\$536	S2	85.5	1.3	59	16.00	
	1800	575	143JMV	<b>GT5201</b>	143TTFR16042	√	\$529	S2	85.5	1.3	57	16.79	
1 1/2	3600	200	143JM	<b>GT3003</b>	143TTFR16007	√	\$630	S2	84.0	4.6	63	15.50	
	3600	200	143JMV	<b>GT5003</b>	143TTFR16005	√	\$622	S2	84.0	4.6	61	16.29	
	3600	230/460	143JM	<b>GT3103</b>	143TTFR16010	√	\$630	S2	84.0	4.0/2.0	63	15.50	
	3600	230/460	143JMV	<b>GT5103</b>	143TTFR16006	√	\$622	S2	84.0	4.0/2.0	61	16.29	
	3600	575	143JM	<b>GT3203</b>	143TTFR16013	√	\$630	S2	84.0	1.6	63	15.50	
	3600	575	143JMV	<b>GT5203</b>	143TTFR16004	√	\$622	S2	84.0	1.6	61	16.29	
	1800	200	145JM	<b>GT3004</b>	145TTFR16059	√	\$587	S2	86.5	5.3	68	16.50	
	1800	200	145JMV	<b>GT5004</b>	145TTFR16058	√	\$580	S2	86.5	5.3	66	17.29	
	1800	230/460	145JM	<b>GT3104</b>	145TTFR16036	√	\$587	S2	86.5	4.6/2.3	68	16.50	
	1800	230/460	145JMV	<b>GT5104</b>	145TTFR16074	√	\$580	S2	86.5	4.6/2.3	66	17.29	
	1800	575	145JM	<b>GT3204</b>	145TTFR16063	√	\$587	S2	86.5	2.0	68	16.50	
	1800	575	145JMV	<b>GT5204</b>	145TTFR16062	√	\$580	S2	86.5	2.0	66	17.29	
2	3600	200	145JM	<b>GT3006</b>	145TTFR16010	√	\$682	S2	85.5	5.8	71	16.50	
	3600	200	145JMV	<b>GT5006</b>	145TTFR16009	√	\$674	S2	85.5	5.8	69	17.29	
	3600	230/460	145JM	<b>GT3106</b>	145TTFR16013	√	\$682	S2	85.5	5.2/2.6	71	16.50	
	3600	230/460	145JMV	<b>GT5106</b>	145TTFR16012	√	\$674	S2	85.5	5.2/2.6	69	17.29	
	3600	575	145JM	<b>GT3206</b>	145TTFR16018	√	\$682	S2	85.5	2.0	71	16.50	
	3600	575	145JMV	<b>GT5206</b>	145TTFR16017	√	\$674	S2	85.5	2.0	69	17.29	
	1800	200	145JM	<b>GT3007</b>	145TTFR16067	√	\$614	S2	86.5	7.6	76	17.00	
	1800	200	145JMV	<b>GT5007</b>	145TTFR16066	√	\$606	S2	86.5	7.6	74	17.79	
	1800	230/460	145JM	<b>GT3107</b>	145TTFR16037	√	\$614	S2	86.5	6.0/3.0	76	17.00	
	1800	230/460	145JMV	<b>GT5107</b>	145TTFR16057	√	\$606	S2	86.5	6.0/3.0	74	17.79	
	1800	575	145JM	<b>GT3207</b>	145TTFR16071	√	\$614	S2	86.5	2.4	76	17.00	
	1800	575	145JMV	<b>GT5207</b>	145TTFR16070	√	\$606	S2	86.5	2.4	74	17.79	

Catalog numbers (Cat No.) highlighted in bold blue have efficiency levels that meet EISA requirements

Continued on next page.

PUMP MOTORS (FLUID HANDLING)

# Globetrotter® NEMA Premium® Efficiency Close-Coupled Pump, JM, Three Phase TEFC, C-Face Footed (Rigid Base)

HP	RPM	VOLTS	FRAME	CAT. NO.	MODEL NUMBER	STOCK	LIST PRICE	MULT. SYMB.	NOM. EFF.	F.L. AMPS	WEIGHT	"C" DIM.	FOOT NOTES
3	3600	230/460	182JM	<b>GT3109</b>	182TTFB6006	✓	\$782	S2	86.5	7.6/3.8	83	17.51	
	3600	575	182JM	<b>GT3209</b>	182TTFB6008	✓	\$782	S2	86.5	3.1	83	17.51	
	1800	230/460	182JM	<b>GT3110</b>	182TTFB6031	✓	\$715	S2	89.5	7.8/3.9	87	17.51	
	1800	575	182JM	<b>GT3210</b>	182TTFB6033	✓	\$715	S2	89.5	3.1	87	17.51	
5	3600	230/460	184JM	<b>GT3112</b>	184TTFB6006	✓	\$928	S2	88.5	12.0/6.0	95	18.36	
	3600	575	184JM	<b>GT3212</b>	184TTFB6008	✓	\$928	S2	88.5	4.8	95	18.36	
	1800	230/460	184JM	<b>GT3113</b>	184TTFB6031	✓	\$864	S2	89.5	12.4/6.2	110	18.36	
	1800	575	184JM	<b>GT3213</b>	184TTFB6033	✓	\$864	S2	89.5	5.0	110	18.36	
7 1/2	3600	230/460	213JM	<b>GT3115</b>	213TTFB6006	✓	\$1,158	S2	88.5	12.0/6.0	116	20.65	
	3600	575	213JM	<b>GT3215</b>	213TTFB6008	✓	\$1,158	S2	88.5	4.8	116	20.65	
	1800	230/460	213JM	<b>GT3116</b>	213TTFB6031	✓	\$1,324	S2	89.5	12.4/6.2	143	20.65	
	1800	575	213JM	<b>GT3216</b>	213TTFB6033	✓	\$1,324	S2	89.5	5.0	143	20.65	
10	3600	230/460	215JM	<b>GT3118</b>	215TTFB6006	✓	\$1,416	S2	90.2	22.8/11.4	137	22.14	
	3600	575	215JM	<b>GT3218</b>	215TTFB6008	✓	\$1,416	S2	90.2	9.1	137	22.14	
	1800	230/460	215JM	<b>GT3119</b>	215TTFB6031	✓	\$1,584	S2	91.7	24.4/12.2	164	22.14	
	1800	575	215JM	<b>GT3219</b>	215TTFB6033	✓	\$1,584	S2	91.7	9.8	164	22.14	
15	3600	230/460	254JM	<b>GT3121</b>	254TTFCA6006	✓	\$1,770	S2	91.0	34/17.0	350	26.60	
	3600	575	254JM	<b>GT3221</b>	254TTFCA6008	✓	\$1,770	S2	91.0	13.6	350	26.60	
	1800	230/460	254JM	<b>GT3122</b>	254TTFCA6031	✓	\$2,147	S2	92.4	37/18.5	375	26.60	
	1800	575	254JM	<b>GT3222</b>	254TTFCA6033	✓	\$2,147	S2	92.4	14.8	375	26.60	
20	3600	230/460	256JM	<b>GT3124</b>	256TTFCA6006	✓	\$2,383	S2	91.0	46.0/23.0	375	27.80	
	3600	575	256JM	<b>GT3224</b>	256TTFCA6008	✓	\$2,383	S2	91.0	18.4	375	27.80	
	1800	230/460	256JM	<b>GT3125</b>	256TTFCA6031	✓	\$2,606	S2	93.0	48.0/24.0	425	27.80	
	1800	575	256JM	<b>GT3225</b>	256TTFCA6033	✓	\$2,606	S2	93.0	19.6	425	27.80	
25	3600	230/460	284JM	<b>GT3127</b>	284TTFCA6006	✓	\$2,087	S2	91.7	55.5/27.7	475	30.92	
	3600	575	284JM	<b>GT3227</b>	284TTFCA6008	✓	\$2,087	S2	91.7	22.4	475	30.92	
	1800	230/460	284JM	<b>GT3128</b>	284TTFCA6032	✓	\$2,437	S2	93.6	62.0/31.0	500	30.92	
	1800	575	284JM	<b>GT3228</b>	284TTFCA6033	✓	\$2,437	S2	93.6	24.4	500	30.92	
30	3600	230/460	286JM	<b>GT3130</b>	286TTFCA6006	✓	\$2,492	S2	91.7	66.0/33.0	500	32.10	
	3600	575	286JM	<b>GT3230</b>	286TTFCA6008	✓	\$2,492	S2	91.7	27.2	500	32.10	
	1800	230/460	286JM	<b>GT3131</b>	286TTFCA6032	✓	\$2,816	S2	93.6	73.0/36.5	525	32.10	
	1800	575	286JM	<b>GT3231</b>	286TTFCA6033	✓	\$2,816	S2	93.6	29.2	252	32.10	
40	3600	230/460	324JM	<b>GT3133</b>	324TTFCA6007	✓	\$3,122	S2	92.4	88.0/44.0	675	32.93	
	3600	575	324JM	<b>GT3233</b>	324TTFCA6008	✓	\$3,122	S2	92.4	35.0	675	32.93	
	1800	230/460	324JM	<b>GT3134</b>	324TTFCA6032	✓	\$3,680	S2	94.1	94.0/47.0	750	32.93	
	1800	575	324JM	<b>GT3234</b>	324TTFCA6033	✓	\$3,680	S2	94.1	37.5	750	32.93	
50	3600	230/460	326JM	<b>GT3136</b>	326TTFCA6007	✓	\$3,993	S2	93.0	109/54.5	725	34.11	
	3600	575	326JM	<b>GT3236</b>	326TTFCA6008	✓	\$3,993	S2	93.0	43.5	725	34.11	
	1800	230/460	326JM	<b>GT3137</b>	326TTFCA6032	✓	\$4,255	S2	94.5	119/59.5	775	34.11	
	1800	575	326JM	<b>GT3237</b>	326TTFCA6033	✓	\$4,255	S2	94.5	47.5	775	34.11	

Catalog numbers (Cat No.) highlighted in bold blue have efficiency levels that meet EISA requirements

Blue shaded areas are Cast Iron Frames



# Close-Coupled Pump, JP, Three Phase

## Dripproof, C-Face Footless (Vertical) and C-Face Footed (Rigid Base)

### Applications:

Close-coupled pumps where the pump impeller is mounted directly on the motor shaft in environments that are relatively clean and dry.

### Features:

- NEMA JP pump shaft dimensions
- JPV frame includes drip cover for vertical mount without base
- JP frame has rigid base, drip cover not included
- Ball bearings, mechanically locked on shaft end
- Continuous duty
- 1.15 Service Factor
- UL Recognized and CSA Certified
- UL Listed for Fire Pump applications (except as noted)



Suitable for use on VFD per guidelines on page 17.

HP	RPM	VOLTS	FRAME	CAT. NO.	MODEL NO.	STOCK	LIST PRICE	MULT. SYMB.	NOM. EFF.	F.L. AMPS	WEIGHT	"C" DIM.	FOOT NOTES
1	1800	200	143JP	<b>U122</b>	143TTDR4042		\$354	S2	82.5	3.6	41	17.68	
	1800	200	143JPV	<b>U125</b>	143TTDR4043		\$395	S2	82.5	3.6	41	17.98	27
	1800	208-230/460	143JP	<b>U123A</b>	143TTDR14048		\$354	S2	82.5	3.3-3.1/1.6	41	17.68	68
	1800	230/460	143JPV	<b>U126</b>	143TTDR4037		\$395	S2	82.5	3.1/1.6	41	17.98	68
	1800	575	143JP	<b>U124</b>	143TTDR4048		\$354	S2	82.5	1.1	42	17.68	
	1800	575	143JPV	<b>U127</b>	143TTDR4049		\$395	S2	82.5	1.1	42	17.98	27
1 1/2	3600	200	143JP	<b>U128</b>	143TTDR4018		\$404	S2	82.5	5.5	46	16.18	95
	3600	200	143JPV	<b>U131</b>	143TTDR4019		\$445	S2	82.5	5.5	45	15.98	27
	3600	208-230/460	143JP	<b>U129A</b>	143TTDR4003	√	\$404	S2	82.5	4.9-5.0/2.5	46	16.18	68,d
	3600	230/460	143JPV	<b>U132</b>	143TTDR4011		\$445	S2	82.5	4.8/2.4	46	15.98	27
	3600	575	143JP	<b>U130</b>	143TTDR4023		\$404	S2	82.5	1.9	47	16.18	1,95
	3600	575	143JPV	<b>U133</b>	143TTDR4025		\$445	S2	82.5	1.9	47	15.98	27
	1800	200	145JP	<b>U134</b>	145TTDR4042		\$386	S2	84.0	5.0	47	17.68	
	1800	200	145JPV	<b>U137</b>	145TTDR4043		\$429	S2	84.0	5.0	47	17.98	27
	1800	208-230/460	145JP	<b>U135A</b>	145TTDR4354	√	\$386	S2	84.0	4.6-4.4/2.2	47	17.68	68
	1800	230/460	145JPV	<b>U138</b>	145TTDR4037	√	\$429	S2	84.0	4.4/2.2	41	17.98	27,68
	1800	575	145JP	<b>U136</b>	145TTDR4048		\$386	S2	84.0	1.8	42	17.68	
	1800	575	145JPV	<b>U139</b>	145TTDR4049		\$429	S2	84.0	1.8	42	17.98	27
2	3600	200	145JP	<b>U140</b>	145TTDR4017		\$364	S2	84.0	6.2	45	16.18	
	3600	200	145JPV	<b>U143</b>	145TTDR4018		\$496	S2	84.0	6.2	45	16.48	27
	3600	230/460	145JP	<b>U141</b>	145TTDR4011		\$454	S2	84.0	5.4/2.7	45	16.18	68
	3600	230/460	145JPV	<b>U144</b>	145TTDR4012		\$496	S2	84.0	5.4/2.7	45	16.48	27,68
	3600	575	145JP	<b>U142</b>	145TTDR4023		\$454	S2	84.0	2.2	45	16.18	
	3600	575	145JPV	<b>U145</b>	145TTDR4024		\$496	S2	84.0	2.2	45	16.48	27
	1800	200	145JP	<b>U146</b>	145TTDR4068		\$404	S2	84.0	6.7	45	18.18	
	1800	200	145JPV	<b>U149</b>	145TTDR4069		\$445	S2	84.0	6.7	45	18.48	27
	1800	208-230/460	145JP	<b>U147A</b>	145TTDR4356	√	\$404	S2	84.0	6.2-5.8/2.9	44	17.98	68
	1800	208-230/460	145JPV	<b>U150A</b>	145TTDR4355		\$445	S2	84.0	6.2-5.8/2.9	44	17.98	27,68
	1800	575	145JP	<b>U148</b>	145TTDR4074		\$404	S2	84.0	2.3	44	18.18	
	1800	575	145JPV	<b>U151</b>	145TTDR4075		\$445	S2	84.0	2.3	44	18.48	27

Catalog numbers (Cat No.) highlighted in bold blue have efficiency levels that meet EISA requirements

Continued on next page.

PUMP MOTORS (FLUID HANDLING)

# Close-Coupled Pump, JP, Three Phase

Dripproof, C-Face Footless (Vertical) and C-Face Footed (Rigid Base)

HP	RPM	VOLTS	FRAME	CAT. NO.	MODEL NO.	STOCK	LIST PRICE	MULT. SYMB.	NOM. EFF.	F.L. AMPS	WEIGHT	"C" DIM.	FOOT NOTES	
3	3600	200	145JP	<b>U152</b>	145TTDR4117		\$507	S2	84.0	10.0	43	16.68		
	3600	200	145JPV	<b>U155</b>	145TTDR4118		\$549	S2	84.0	10.0	43	16.98	27	
	3600	230/460	145JP	<b>U153</b>	145TTDR4111	√	\$507	S2	84.0	8.4/4.2	42	16.68	68	
	3600	230/460	145JPV	<b>U156</b>	145TTDR4112		\$549	S2	84.0	8.4/4.2	45	16.98	27,68	
	3600	575	145JP	<b>U154</b>	145TTDR4123		\$507	S2	84.0	3.5	46	16.68		
	3600	575	145JPV	<b>U157</b>	145TTDR4124		\$549	S2	84.0	3.5	45	16.98	27	
	1800	200	182JP	<b>U158</b>	182TTDR4142		\$471	S2	86.5	9.4	51	19.66	13	
	1800	200	182JPV	<b>U161</b>	182TTDR4143		\$555	S2	86.5	9.4	52	19.91	27	
	1800	208-230/460	182JP	<b>U159A</b>	182TTDW4338		\$471	S2	86.5	9.0-8.8/4.4	70	17.46	13,68	
	1800	230/460	182JPV	<b>U162</b>	182TTDR4048		\$555	S2	86.5	8.6/4.3	102	19.84	13,27	
	1800	575	182JP	<b>U160</b>	182TTDR4148		\$471	S2	86.5	3.45	103	19.66	13	
	1800	575	182JPV	<b>U163</b>	182TTDR4149		\$555	S2	86.5	3.45	102	19.91	13,27	
	5	3600	200	182JP	<b>U164</b>	182TTDR4118		\$608	S2	86.5	13.8	78	19.16	13
		3600	200	182JPV	<b>U167</b>	182TTDR4119		\$690	S2	86.5	13.8	81	19.84	13,27
		3600	208-230/460	182JP	<b>U165A</b>	182TTDW14011	√	\$608	S2	85.5	14.0-12.4/6.2	97	17.96	68
3600		230/460	182JPV	<b>U168</b>	182TTDR4113		\$690	S2	86.5	12.0/6.0	85	19.84	27	
3600		575	182JP	<b>U166</b>	182TTDR4124		\$608	S2	86.5	4.8	76	19.16	13	
3600		575	182JPV	<b>U169</b>	182TTDR4125		\$690	S2	86.5	4.8	72	19.84	13,27	
1800		200	184JP	<b>U170</b>	184TTDR4142		\$608	S2	87.5	14.5	74	20.41	13	
1800		200	184JPV	<b>U173</b>	184TTDR4143		\$690	S2	87.5	14.5	72	20.84	27	
1800		208-230/460	184JP	<b>M115A</b>	184TTDW7358	√	\$487	S2	87.5	16.0-14.8/7.4	74	17.88	13,68	
1800		208-230/460	184JPV	<b>U299</b>	184TTDW4039		\$690	S2	87.5	14.5-13.2/6.6	87	21.66	27,68,98	
1800		230/460	184JP	<b>U171A</b>	184TTDW4136		\$608	S2	87.5	12.6/6.3	54	20.41	13	
1800		575	184JP	<b>U172</b>	184TTDR4148		\$608	S2	87.5	5.3	69	20.16	13	
1800		575	184JPV	<b>U175</b>	184TTDR4149		\$690	S2	87.5	5.0	72	20.84	27	
7 1/2		3600	200	184JP	<b>U176</b>	184TTDR4117		\$731	S2	87.5	20.7	72	20.16	13
		3600	200	184JPV	<b>U179</b>	184TTDR4118		\$815	S2	87.5	20.2	72	20.84	27
	3600	208-230/460	184JP	<b>U177A</b>	184TTDW14079	√	\$731	S2	87.5	20.0-17.6/8.8	131	18.88	13,68	
	3600	230/460	184JPV	<b>U180</b>	184TTDR4112		\$815	S2	87.5	17.6/8.8	131	20.32	27	
	3600	575	184JP	<b>U178</b>	184TTDR4123		\$731	S2	87.5	7.2	131	20.16	13	
	3600	575	184JPV	<b>U181</b>	184TTDR4124		\$815	S2	87.5	7.2	136	20.32	27	
	1800	200	213JP	<b>U182</b>	213TTDW4044		\$879	S2	88.5	22.1	137	23.03		
	1800	200	213JPV	<b>U185</b>	213TTDW4051		\$990	S2	88.5	22.1	123	24.31	27	
	1800	230/460	213JP	<b>U183</b>	213TTDW4049	√	\$879	S2	88.5	19.2/9.6	141	23.03	68	
	1800	230/460	213JPV	<b>U186A</b>	213TTDW14059		\$990	S2	88.5	19.4/9.2	141	23.03	27,68	
	1800	575	213JP	<b>U184</b>	213TTDW4039		\$879	S2	88.5	7.6	138	23.03		
	1800	575	213JPV	<b>U187</b>	213TTDW4052		\$990	S2	88.5	7.7	140	24.31	27	

Catalog numbers (Cat No.) highlighted in bold blue have efficiency levels that meet EISA requirements

Continued on next page.

# Close-Coupled Pump, JP, Three Phase

## Drip-proof, C-Face Footless (Vertical) and C-Face Footed (Rigid Base)

HP	RPM	VOLTS	FRAME	CAT. NO.	MODEL NO.	STOCK	LIST PRICE	MULT. SYMB.	NOM. EFF.	F.L. AMPS	WEIGHT	"C" DIM.	FOOT NOTES	
10	3600	200	213JP	<b>U188</b>	213TTDW4011		\$940	S2	88.5	26.9	130	23.03		
	3600	200	213JPV	<b>U191</b>	213TTDW4013		\$1,049	S2	88.5	26.9	130	24.31	27	
	3600	208-230/460	213JP	<b>U189A</b>	213TTDW14013	√	\$940	S2	88.5	26.0-23.4/11.7	132	23.03	68	
	3600	230/460	213JPV	<b>U192</b>	213TTDW4025		\$1,049	S2	88.5	23.4/11.7	134	24.31	27,68	
	3600	575	213JP	<b>U190</b>	213TTDW4012		\$940	S2	88.5	9.4	135	23.03		
	3600	575	213JPV	<b>U193</b>	213TTDW4014		\$1,049	S2	88.5	9.3	130	24.31	27	
	1800	200	215JP	<b>U194</b>	215TTDW4044		\$1,043	S2	89.5	28.8	156	23.03		
	1800	200	215JPV	<b>U197</b>	215TTDW4053		\$1,152	S2	89.5	28.8	163	24.31	27	
	1800	230/460	215JP	<b>U195</b>	215TTDW4049	√	\$1,043	S2	89.5	25.0/12.5	225	23.03	68	
	1800	208-230/460	215JPV	<b>U198A</b>	215TTDW14073		\$1,152	S2	89.5	28.0-25.0/12.5	225	24.38	27,68	
	1800	575	215JP	<b>U196</b>	215TTDW4051		\$1,043	S2	89.5	10.0	135	23.03		
	1800	575	215JPV	<b>U199</b>	215TTDW4052		\$1,152	S2	89.0	10.0	137	24.31	27	
	15	3600	200	215JP	<b>U200</b>	215TTDW4011		\$1,161	S2	90.2	39.0	138	24.28	13,27
		3600	200	215JPV	<b>U203</b>	215TTDW4013		\$1,272	S2	90.2	39.1	139	25.56	27
		3600	230/460	215JP	<b>U201A</b>	215TTDW14020	√	\$1,161	S2	90.2	34.0/17.0	220	24.28	68
3600		230/460	215JPV	<b>U204</b>	215TTDW4025		\$1,272	S2	90.2	34.0/17.0	135	25.56	27,68	
3600		575	215JP	<b>U202</b>	215TTDW4012		\$1,161	S2	90.2	13.6	168	24.28		
3600		575	215JPV	<b>U205</b>	215TTDW4014		\$1,272	S2	90.2	13.6	215	25.56	27	
1800		200	254JP	<b>U206</b>	254TTDX4074		\$1,410	S2	91.0	44.0	220	27.04		
1800		200	254JPV	<b>U209</b>	254TTDX4060		\$1,571	S2	91.0	44.0	198	28.33	27	
1800		230/460	254JP	<b>U207</b>	254TTDX4075	√	\$1,410	S2	91.0	38.5/19.2	214	27.04		
1800		230/460	254JPV	<b>U210</b>	254TTDX4041	√	\$1,571	S2	91.0	38.5/19.2	224	28.33	27	
1800		575	254JP	<b>U208</b>	254TTDX4340		\$1,410	S2	91.0	15.4	260	27.04		
1800		575	254JPV	<b>U211</b>	254TTDX4341		\$1,571	S2	91.0	15.4	220	28.33	27	
20	3600	200	254JP	<b>U212</b>	254TTDX4014		\$1,465	S2	91.0	53.1	200	25.29	d,68,98	
	3600	200	254JPV	<b>U215</b>	254TTDX4010		\$1,625	S2	91.0	53.1	200	26.58	27	
	3600	230/460	254JP	<b>U213</b>	254TTDX4017	√	\$1,465	S2	91.0	46.0/23.1	213	25.29		
	3600	230/460	254JPV	<b>U216</b>	254TTDX4012		\$1,625	S2	91.0	46.0/23.1	150	26.58	27,68	
	3600	575	254JP	<b>U214</b>	254TTDX4008		\$1,465	S2	91.0	18.0	203	25.29		
	3600	575	254JPV	<b>U217</b>	254TTDX4016		\$1,625	S2	91.0	18.5	200	26.58	27	
	1800	200	256JP	<b>U218</b>	256TTDX4064		\$1,702	S2	91.0	60.0	225	27.04		
	1800	200	256JPV	<b>U221</b>	256TTDX4065		\$1,860	S2	91.0	59.8	235	28.33	27	
	1800	230/460	256JP	<b>U219</b>	256TTDX4063	√	\$1,702	S2	91.0	52.0/26.0	328	27.04	68	
	1800	575	256JP	<b>U220</b>	256TTDX4328		\$1,702	S2	91.0	20.8	136	27.04		
	1800	575	256JPV	<b>U223</b>	256TTDX4059		\$1,860	S2	91.0	20.8	220	28.33	27	
25	3600	200	256JP	<b>U224</b>	256TTDX4022		\$1,723	S2	91.0	66.7	235	27.04	27	
	3600	230/460	256JP	<b>U225</b>	256TTDX4004	√	\$1,723	S2	91.0	58.0/29.0	185	27.04	68	
	3600	575	256JP	<b>U226</b>	256TTDX4023		\$1,723	S2	91.0	23.2	255	27.04		

Catalog numbers (Cat No.) highlighted in bold blue have efficiency levels that meet EISA requirements

Continued on next page.

## Close-Coupled Pump, JP, Three Phase Drip-proof, C-Face Footed (Rigid Base)

HP	RPM	VOLTS	FRAME	CAT. NO.	MODEL NO.	STOCK	LIST PRICE	MULT. SYMB.	NOM. EFF.	F.L. AMPS	WEIGHT	"C" DIM.	FOOT NOTES
25	1800	200	284JP	<b>U227</b>	284TTDP4044		\$2,058	S2	91.7	70.0	420	27.18	
	1800	230/460	284JP	<b>U228A</b>	284TTDP14044	✓	\$2,058	S2	91.7	61.0/30.5	310	27.18	68
	1800	575	284JP	<b>U229</b>	284TTDP4045		\$2,058	S2	91.7	24.5	348	27.18	
30	3600	200	284JP	<b>U230</b>	284TTDP4011		\$2,101	S2	91.0	83.0	361	27.18	27,68
	3600	230/460	284JP	<b>U231</b>	284TTDP4022	✓	\$2,101	S2	91.0	72.0/36.0	368	27.18	68
	3600	575	284JP	<b>U232</b>	284TTDP4012		\$2,101	S2	91.0	29.0	428	27.18	
	1800	200	286JP	<b>U233</b>	286TTDP4048		\$2,377	S2	92.4	83.0	330	28.68	
	1800	230/460	286JP	<b>U234</b>	286TTDP4074	✓	\$2,377	S2	92.4	72.0/36.0	331	28.68	68
	1800	575	286JP	<b>U235</b>	286TTDP4049		\$2,377	S2	92.4	28.8	425	28.68	
40	3600	230/460	286JP	<b>U236</b>	286TTDP4020	✓	\$2,629	S2	91.7	94.0/47.0	428	28.68	68
	3600	575	286JP	<b>U237</b>	286TTDP4024		\$2,629	S2	91.7	38.0	327	28.68	
	1800	230/460	324JP	<b>U238</b>	324TTDP4348	✓	\$3,106	S2	93.0	97.0/48.5	487	29.12	68
	1800	575	324JP	<b>U239</b>	324TTDP4033		\$3,106	S2	93.0	39.0	474	29.12	
50	3600	230/460	324JP	<b>U240</b>	324TTDP4002	✓	\$3,364	S2	92.4	117/58.5	478	29.12	68
	3600	575	324JP	<b>U241</b>	324TTDP4011		\$3,385	S2	92.4	47.0	424	29.12	
	1800	230/460	326JP	<b>U242</b>	326TTDP4340	✓	\$3,587	S2	93.0	123/61.5	585	30.62	68
	1800	575	326JP	<b>U243</b>	326TTDP4032		\$3,587	S2	93.0	49.0	490	30.62	

Catalog numbers (Cat No.) highlighted in bold blue have efficiency levels that meet EISA requirements

Blue shaded areas are Cast Iron Frames

## Close-Coupled Pump, JP, Three Phase Totally Enclosed, C-Face Footed (Rigid Base)

### Applications:

Close-coupled pumps where the pump impeller is mounted directly on the motor shaft in damp, dusty, or dirty environments.

### Features:

- More ratings available, contact Marathon for price and availability
- NEMA JP pump shaft dimensions
- Ball bearings, mechanically locked on shaft end
- Continuous duty
- 1.15 Service Factor
- UL Recognized and CSA Certified



Suitable for use on VFD per guidelines on page 17.

HP	RPM	VOLTS	FRAME	CAT. NO.	MODEL NO.	STOCK	LIST PRICE	MULT. SYMB.	NOM. EFF.	F.L. AMPS	WEIGHT	"C" DIM.	FOOT NOTES
7 1/2	3600	200	213JP	<b>U328</b>	213TTFW4011		\$949	S2	89.5	21.2	96	25.96	
	3600	208-230/460	184JP	<b>U372</b>	184TTFW4914	✓	\$767	S2	88.5	17.6-16.8/8.4	90	21.20	13,68
	3600	575	213JP	<b>U332</b>	213TTFW4012		\$949	S2	89.5	7.4	98	25.96	
15	3600	200	254JP	<b>U343</b>	254TTFW4009		\$1,451	S2	91.0	40.3	197	27.60	AL
	3600	208-230/460	215JP	<b>U366</b>	215TTFW14302		\$1,182	S2	90.2	40.0-37.0/18.5	193	25.96	68
	3600	230/460	254JP	<b>U345A</b>	254TTFW14008		\$1,451	S2	91.0	35.0/17.5	173	27.55	AL,68
	3600	575	254JP	<b>U356</b>	254TTFW4011		\$1,451	S2	91.0	14.0	173	27.60	AL

Catalog numbers (Cat No.) highlighted in bold blue have efficiency levels that meet EISA requirements

# Globetrotter® NEMA Premium® Efficiency Close-Coupled Pump, JP, Three Phase Dripproof, C-Face Footed (Rigid Base)

Features:

- ⊛ Meets or exceeds NEMA Premium® efficiencies NEMA Premium® models are in compliance with EISA2007
- Inverter Duty 10:1 Variable Torque and 2:1 Constant Torque, 1.0 SF
- Nameplated 60/50 hertz, 190/380 volts at next lower HP
- 1.15 Service Factor
- Class F Insulation
- Standard assembly F1, reversible to F2 assembly
- UL Recognized, CSA Certified, CE Mark
- Three year warranty



HP	RPM	VOLTS	FRAME	CAT. NO.	MODEL NUMBER	STOCK	LIST PRICE	MULT. SYMB.	NOM. EFF.	F.L. AMPS	WEIGHT	"C" DIM.	FOOT NOTES
1	1800	200	143JP	<b>GT2301</b>	143TTDR16044	✓	\$415	S2	85.5	2.5	41	14.62	
	1800	200	143JPV	<b>GT4301</b>	143TTDR16045	✓	\$415	S2	85.5	2.5	41	14.62	
	1800	230/460	143JP	<b>GT2401</b>	143TTDR16048	✓	\$415	S2	85.5	3.0/1.5	41	14.62	
	1800	230/460	143JPV	<b>GT4401</b>	143TTDR16049	✓	\$415	S2	85.5	3.2/1.6	41	14.62	
	1800	575	143JP	<b>GT2501</b>	143TTDR16040	✓	\$415	S2	85.5	1.2	41	14.62	
	1800	575	143JPV	<b>GT4501</b>	143TTDR16041	✓	\$415	S2	85.5	1.2	41	14.62	
1-1/2	3600	200	143JP	<b>GT2303</b>	143TTDR16010	✓	\$474	S2	84.0	4.4	40	13.12	
	3600	200	143JPV	<b>GT4303</b>	143TTDR16011	✓	\$474	S2	84.0	4.4	40	13.12	
	3600	230/460	143JP	<b>GT2403</b>	143TTDR16015	✓	\$474	S2	84.0	3.8/1.90	40	13.12	
	3600	230/460	143JPV	<b>GT4403</b>	143TTDR16014	✓	\$474	S2	84.0	4.0/2.0	40	13.12	
	3600	575	143JP	<b>GT2503</b>	143TTDR16006	✓	\$474	S2	84.0	1.5	40	13.12	
	3600	575	143JPV	<b>GT4503</b>	143TTDR16008	✓	\$474	S2	84.0	1.7	40	13.12	
	1800	200	145JP	<b>GT2304</b>	145TTDR16075	✓	\$452	S2	86.5	5.6	44	14.62	
	1800	200	145JPV	<b>GT4304</b>	145TTDR16326	✓	\$452	S2	86.5	5.6	44	14.62	
	1800	230/460	145JP	<b>GT2404</b>	145TTDR16330	✓	\$452	S2	86.5	4.4/2.2	44	14.62	
	1800	230/460	145JPV	<b>GT4404</b>	145TTDR16331	✓	\$452	S2	86.5	4.8/2.4	44	14.62	
	1800	575	145JP	<b>GT2504</b>	145TTDR16327	✓	\$452	S2	86.5	1.8	44	14.62	
	1800	575	145JPV	<b>GT4504</b>	145TTDR16328	✓	\$452	S2	86.5	1.8	44	14.62	
2	3600	200	145JP	<b>GT2306</b>	145TTDR16014	✓	\$532	S2	85.5	5.2	43	13.12	
	3600	200	145JPV	<b>GT4306</b>	145TTDR16307	✓	\$532	S2	85.5	5.2	43	13.12	
	3600	230/460	145JPV	<b>GT4406</b>	145TTDR16021	✓	\$532	S2	85.5	4.8/2.4	43	13.12	
	3600	575	145JP	<b>GT2506</b>	145TTDR16017	✓	\$532	S2	85.5	2.0	43	13.12	
	3600	575	145JPV	<b>GT4506</b>	145TTDR16016	✓	\$532	S2	85.5	2.0	43	13.12	
	1800	200	145JP	<b>GT2307</b>	145TTDR16337	✓	\$512	S2	86.5	6.0	45	15.12	
	1800	200	145JPV	<b>GT4307</b>	145TTDR16342	✓	\$512	S2	86.5	6.0	45	15.12	
	1800	230/460	145JP	<b>GT2407</b>	145TTDR16333	✓	\$512	S2	86.5	6.0/3.0	45	15.12	
	1800	230/460	145JPV	<b>GT4407</b>	145TTDR16334	✓	\$512	S2	86.5	5.8/2.9	45	15.12	
	1800	575	145JP	<b>GT2507</b>	145TTDR16339	✓	\$512	S2	86.5	2.5	45	15.12	
	1800	575	145JPV	<b>GT4507</b>	145TTDR16340	✓	\$512	S2	86.5	2.5	45	15.12	

Catalog numbers (Cat No.) highlighted in bold blue have efficiency levels that meet EISA requirements

Continued on next page.

PUMP MOTORS (FLUID HANDLING)

# Globetrotter® NEMA Premium® Efficiency Close-Coupled Pump, JP, Three Phase

Drip-proof, C-Face Footed (Rigid Base)

HP	RPM	VOLTS	FRAME	CAT. NO.	MODEL NUMBER	STOCK	LIST PRICE	MULT. SYMB.	NOM. EFF.	F.L. AMPS	WEIGHT	"C" DIM.	FOOT NOTES
3	3600	200	145JP	<b>GT2309</b>	145TTDR16024	✓	\$595	S2	86.5	8.0	47	13.62	
	3600	200	145JPV	<b>GT4309</b>	145TTDR16025	✓	\$595	S2	86.5	8.0	47	13.62	
	3600	230/460	145JP	<b>GT2409</b>	145TTDR16301	✓	\$595	S2	86.5	7.6/3.8	47	13.62	
	3600	230/460	145JPV	<b>GT4409</b>	145TTDR16306	✓	\$595	S2	86.5	7.2/3.6	47	13.62	
	3600	575	145JP	<b>GT2509</b>	145TTDR16303	✓	\$595	S2	86.5	3.1	47	13.62	
	3600	575	145JPV	<b>GT4509</b>	145TTDR16304	✓	\$595	S2	86.5	2.8	47	13.62	
	1800	230/460	182JP	<b>GT2410</b>	182TTDB6037	✓	\$566	S2	89.5	8.4-7.8/3.9	123	15.35	
1800	575	182JP	<b>GT2510</b>	182TTDB6038	✓	\$566	S2	89.5	3.1	123	15.35		
5	3600	230/460	182JP	<b>GT2412</b>	182TTDB6012	✓	\$715	S2	86.5	13.2-11.8/5.9	131	15.35	
	3600	575	182JP	<b>GT2512</b>	182TTDB6013	✓	\$715	S2	86.5	4.7	131	15.35	
	1800	230/460	184JP	<b>GT2413</b>	184TTDB6037	✓	\$687	S2	89.5	13.6-12.4/6.2	135	16.34	
	1800	575	184JP	<b>GT2513</b>	184TTDB6038	✓	\$687	S2	89.5	5.0	135	16.34	
7-1/2	3600	230/460	184JP	<b>GT2415</b>	184TTDB6012	✓	\$858	S2	88.5	19.0-17.2/8.6	149	16.34	A
	3600	575	184JP	<b>GT2515</b>	184TTDB6013	✓	\$858	S2	88.5	6.9	149	16.34	
	1800	230/460	213JP	<b>GT2416</b>	213TTDB6037	✓	\$1,047	S2	91.0	20.4-18.6/9.3	166	17.68	
	1800	575	213JP	<b>GT2516</b>	213TTDB6038	✓	\$1,047	S2	91.0	7.5	166	17.68	
10	3600	230/460	213JP	<b>GT2418</b>	213TTDB6012	✓	\$1,106	S2	89.5	25.5-23/11.5	156	17.68	
	3600	575	213JP	<b>GT2518</b>	213TTDB6013	✓	\$1,106	S2	89.5	9.2	156	17.68	
	1800	230/460	215JP	<b>GT2419</b>	215TTDB6037	✓	\$1,225	S2	91.7	26.9-24.4/12.2	229	19.17	
	1800	575	215JP	<b>GT2519</b>	215TTDB6038	✓	\$1,225	S2	91.7	9.8	229	19.17	
15	3600	230/460	215JP	<b>GT2421</b>	215TTDB6012	✓	\$1,366	S2	90.2	38.0-34.0/17.0	191	19.17	
	3600	575	215JP	<b>GT2521</b>	215TTDB6013	✓	\$1,366	S2	90.2	13.6	191	19.17	
	1800	230/460	254JP	<b>GT2422</b>	254TTDCA6037	✓	\$1,646	S2	93.0	38.0/19.0	322	24.41	
	1800	575	254JP	<b>GT2522</b>	254TTDCA6038	✓	\$1,646	S2	93.0	15.2	322	24.41	
20	3600	230/460	254JP	<b>GT2424</b>	254TTDCA6012	✓	\$1,705	S2	91.0	51.0-46.0/23.0	312	24.41	
	3600	575	254JP	<b>GT2524</b>	254TTDCA6013	✓	\$1,705	S2	91.0	18.4	312	24.41	
	1800	230/460	256JP	<b>GT2425</b>	256TTDCA6037	✓	\$2,021	S2	93.0	53.0-49.0/24.5	374	26.00	
	1800	575	256JP	<b>GT2525</b>	256TTDCA6038	✓	\$2,021	S2	93.0	19.6	374	26.00	
25	3600	230/460	256JP	<b>GT2427</b>	256TTDCA6012	✓	\$2,062	S2	91.7	64.0-57.0/28.5	328	26.00	
	3600	575	256JP	<b>GT2527</b>	256TTDCA6013	✓	\$2,062	S2	91.7	22.8	328	26.00	
	1800	230/460	284JP	<b>GT2428</b>	284TTDCA6037	✓	\$2,412	S2	93.6	66.0-62.0/31.0	441	26.58	
	1800	575	284JP	<b>GT2528</b>	284TTDCA6038	✓	\$2,412	S2	93.6	24.8	441	26.58	
30	3600	230/460	284JP	<b>GT2430</b>	284TTDCA6012	✓	\$2,462	S2	91.7	76.0-68.0/34.0	412	26.58	
	3600	575	284JP	<b>GT2530</b>	284TTDCA6013	✓	\$2,462	S2	91.7	27.2	412	26.58	
	1800	230/460	286JP	<b>GT2431</b>	286TTDCA6037	✓	\$2,786	S2	94.1	81.0-74.0/37.0	502	27.10	
	1800	575	286JP	<b>GT2531</b>	286TTDCA6038	✓	\$2,786	S2	94.1	29.6	502	27.10	
40	3600	230/460	286JP	<b>GT2433</b>	286TTDCA6012	✓	\$3,082	S2	92.4	100-90.0/45.0	470	27.10	
	3600	575	286JP	<b>GT2533</b>	286TTDCA6013	✓	\$3,082	S2	92.4	36.0	470	27.10	
	1800	230/460	324JP	<b>GT2434</b>	324TTDCA6037	✓	\$3,640	S2	94.1	105-95.0/47.5	604	28.95	
	1800	575	324JP	<b>GT2534</b>	324TTDCA6038	✓	\$3,640	S2	94.1	40.4	604	28.95	
50	3600	230/460	324JP	<b>GT2436</b>	324TTDCA6012	✓	\$3,943	S2	93.0	124-113/56.5	570	28.95	
	3600	575	324JP	<b>GT2536</b>	324TTDCA6013	✓	\$3,943	S2	93.0	45.0	570	28.95	
	1800	230/460	326JP	<b>GT2437</b>	326TTDCA6037	✓	\$4,205	S2	94.5	131-118/59.0	738	30.12	
1800	575	326JP	<b>GT2537</b>	326TTDCA6038	✓	\$4,205	S2	94.5	47.0	738	30.12		

PUMP MOTORS (FLUID HANDLING)

Catalog numbers (Cat No.) highlighted in bold blue have efficiency levels that meet EISA requirements

Blue shaded areas are Cast Iron Frames

# Globetrotter® NEMA Premium® Efficiency Close-Coupled Pump, JP, Three Phase TEFC, C-Face Footed (Rigid Base)

Features:

- ⚡ Meets or exceeds NEMA Premium® efficiencies NEMA Premium® models are in compliance with EISA2007
- Inverter Duty 10:1 Variable Torque and 2:1 Constant Torque, 1.0 SF
- Dual rated motors are nameplated 60/50 hertz, 190/380 volts at next lower HP
- 1.15 Service Factor
- Class F Insulation
- Standard assembly F1, reversible to F2 assembly
- UL Recognized, CSA Certified, CE Mark
- Three year warranty



HP	RPM	VOLTS	FRAME	CAT. NO.	MODEL NUMBER	STOCK	LIST PRICE	MULT. SYMB.	NOM. EFF.	F.L. AMPS	WEIGHT	"C" DIM.	FOOT NOTES
1	1800	200	143JP	<b>GT3301</b>	143TTFR16049	✓	\$536	S2	85.5	3.8	59	19.13	
	1800	200	143JPV	<b>GT5301</b>	143TTFR16050	✓	\$529	S2	85.5	3.8	57	19.85	
	1800	230/460	143JP	<b>GT3401</b>	143TTFR16051	✓	\$536	S2	85.5	3.3/1.65	59	19.13	
	1800	230/460	143JPV	<b>GT5401</b>	143TTFR16043	✓	\$529	S2	85.5	3.3/1.65	57	19.85	
	1800	575	143JP	<b>GT3501</b>	143TTFR16044	✓	\$536	S2	85.5	1.3	59	19.13	
	1800	575	143JPV	<b>GT5501</b>	143TTFR16045	✓	\$529	S2	85.5	1.3	57	19.85	
1 1/2	3600	200	143JP	<b>GT3303</b>	143TTFR16009	✓	\$630	S2	84.0	4.6	63	18.63	
	3600	200	143JPV	<b>GT5303</b>	143TTFR16008	✓	\$622	S2	84.0	4.6	61	19.35	
	3600	230/460	143JP	<b>GT3403</b>	143TTFR16011	✓	\$630	S2	84.0	4.0/2.0	63	18.63	
	3600	230/460	143JPV	<b>GT5403</b>	143TTFR16012	✓	\$622	S2	84.0	4.0/2.0	61	19.35	
	3600	575	143JP	<b>GT3503</b>	143TTFR16015	✓	\$630	S2	84.0	1.6	63	18.63	
	3600	575	143JPV	<b>GT5503</b>	143TTFR16014	✓	\$622	S2	84.0	1.6	61	19.35	
	1800	200	145JP	<b>GT3304</b>	145TTFR16060	✓	\$587	S2	86.5	5.3	68	19.63	
	1800	200	145JPV	<b>GT5304</b>	145TTFR16061	✓	\$580	S2	86.5	5.3	66	20.35	
	1800	230/460	145JP	<b>GT3404</b>	145TTFR16326	✓	\$587	S2	86.5	4.6/2.3	68	19.63	
	1800	230/460	145JPV	<b>GT5404</b>	145TTFR16075	✓	\$580	S2	86.5	4.6/2.3	66	20.35	
	1800	575	145JP	<b>GT3504</b>	145TTFR16064	✓	\$587	S2	86.5	2.0	68	19.63	
	1800	575	145JPV	<b>GT5504</b>	145TTFR16065	✓	\$580	S2	86.5	2.0	66	20.35	
2	3600	200	145JP	<b>GT3306</b>	145TTFR16016	✓	\$682	S2	85.5	5.8	71	19.63	
	3600	200	145JPV	<b>GT5306</b>	145TTFR16011	✓	\$674	S2	85.5	5.8	69	20.35	
	3600	230/460	145JP	<b>GT3406</b>	145TTFR16014	✓	\$682	S2	85.5	5.2/2.6	71	19.63	
	3600	230/460	145JPV	<b>GT5406</b>	145TTFR16015	✓	\$674	S2	85.5	5.2/2.6	69	20.35	
	3600	575	145JP	<b>GT3506</b>	145TTFR16021	✓	\$682	S2	85.5	2.0	71	19.63	
	3600	575	145JPV	<b>GT5506</b>	145TTFR16019	✓	\$674	S2	85.5	2.0	69	20.35	
	1800	200	145JP	<b>GT3307</b>	145TTFR16068	✓	\$614	S2	86.5	7.6	76	20.13	
	1800	200	145JPV	<b>GT5307</b>	145TTFR16069	✓	\$606	S2	86.5	7.6	74	20.85	
	1800	230/460	145JP	<b>GT3407</b>	145TTFR16056	✓	\$614	S2	86.5	6.0/3.0	76	20.13	
	1800	230/460	145JPV	<b>GT5407</b>	145TTFR16055	✓	\$606	S2	86.5	6.0/3.0	74	20.85	
	1800	575	145JP	<b>GT3507</b>	145TTFR16072	✓	\$614	S2	86.5	2.4	76	20.13	
	1800	575	145JPV	<b>GT5507</b>	145TTFR16073	✓	\$606	S2	86.5	2.4	74	20.85	

Catalog numbers (Cat No.) highlighted in bold blue have efficiency levels that meet EISA requirements

Continued on next page.

PUMP MOTORS (FLUID HANDLING)

# Globetrotter® NEMA Premium® Efficiency Close-Coupled Pump, JP, Three Phase

TEFC, C-Face Footed (Rigid Base)

HP	RPM	VOLTS	FRAME	CAT. NO.	MODEL NUMBER	STOCK	LIST PRICE	MULT. SYMB.	NOM. EFF.	F.L. AMPS	WEIGHT	"C" DIM.	FOOT NOTES
3	3600	230/460	182JP	<b>GT3409</b>	182TTFB6012	√	\$782	S2	86.5	7.6/3.8	83	19.07	
	3600	575	182JP	<b>GT3509</b>	182TTFB6013	√	\$782	S2	86.5	3.1	83	19.07	
	1800	230/460	182JP	<b>GT3410</b>	182TTFB6037	√	\$715	S2	89.5	7.8/3.9	87	19.07	
	1800	575	182JP	<b>GT3510</b>	182TTFB6038	√	\$715	S2	89.5	3.1	87	19.07	
5	3600	230/460	184JP	<b>GT3412</b>	184TTFB6012	√	\$928	S2	88.5	12.0/6.0	95	20.05	
	3600	575	184JP	<b>GT3512</b>	184TTFB6013	√	\$928	S2	88.5	4.8	95	20.05	
	1800	230/460	184JP	<b>GT3413</b>	184TTFB6037	√	\$864	S2	89.5	12.4/6.2	110	20.05	
	1800	575	184JP	<b>GT3513</b>	184TTFB6038	√	\$864	S2	89.5	5.0	110	20.05	
7 1/2	3600	230/460	213JP	<b>GT3415</b>	213TTFB6012	√	\$1,158	S2	88.5	12.0/6.0	116	24.54	
	3600	575	213JP	<b>GT3515</b>	213TTFB6013	√	\$1,158	S2	88.5	4.8	116	24.54	
	1800	230/460	213JP	<b>GT3416</b>	213TTFB6037	√	\$1,324	S2	89.5	12.4/6.2	143	24.54	
	1800	575	213JP	<b>GT3516</b>	213TTFB6038	√	\$1,324	S2	89.5	5.0	143	24.54	
10	3600	230/460	215JP	<b>GT3418</b>	215TTFB6012	√	\$1,416	S2	90.2	22.8/11.4	137	26.03	
	3600	575	215JP	<b>GT3518</b>	215TTFB6013	√	\$1,416	S2	90.2	9.1	137	26.03	
	1800	230/460	215JP	<b>GT3419</b>	215TTFB6037	√	\$1,584	S2	91.7	24.4/12.2	164	26.03	
	1800	575	215JP	<b>GT3519</b>	215TTFB6038	√	\$1,584	S2	91.7	9.8	164	26.03	
15	3600	230/460	254JP	<b>GT3421</b>	254TTFCA6012	√	\$1,770	S2	91.0	34/17.0	350	29.51	
	3600	575	254JP	<b>GT3521</b>	254TTFCA6013	√	\$1,770	S2	91.0	13.6	350	29.51	
	1800	230/460	254JP	<b>GT3422</b>	254TTFCA6037	√	\$2,147	S2	92.4	37/18.5	375	29.51	
	1800	575	254JP	<b>GT3522</b>	254TTFCA6038	√	\$2,147	S2	92.4	14.8	375	29.51	
20	3600	230/460	256JP	<b>GT3424</b>	256TTFCA6012	√	\$2,383	S2	91.0	46.0/23.0	375	30.71	
	3600	575	256JP	<b>GT3524</b>	256TTFCA6013	√	\$2,383	S2	91.0	18.4	375	30.71	
	1800	230/460	256JP	<b>GT3425</b>	256TTFCA6037	√	\$2,606	S2	93.0	48.0/24.0	425	30.71	
	1800	575	256JP	<b>GT3525</b>	256TTFCA6038	√	\$2,606	S2	93.0	19.6	425	30.71	
25	3600	230/460	284JP	<b>GT3427</b>	284TTFCA6012	√	\$2,087	S2	91.7	55.5/27.7	475	33.82	
	3600	575	284JP	<b>GT3527</b>	284TTFCA6013	√	\$2,087	S2	91.7	22.4	475	33.82	
	1800	230/460	284JP	<b>GT3428</b>	284TTFCA6037	√	\$2,437	S2	93.6	62.0/31.0	500	33.82	
	1800	575	284JP	<b>GT3528</b>	284TTFCA6038	√	\$2,437	S2	93.6	24.4	500	33.82	
30	3600	230/460	286JP	<b>GT3430</b>	286TTFCA6012	√	\$2,492	S2	91.7	66.0/33.0	500	35.00	
	3600	575	286JP	<b>GT3530</b>	286TTFCA6013	√	\$2,492	S2	91.7	27.2	500	35.00	
	1800	230/460	286JP	<b>GT3431</b>	286TTFCA6037	√	\$2,816	S2	93.6	73.0/36.5	525	35.00	
	1800	575	286JP	<b>GT3531</b>	286TTFCA6038	√	\$2,816	S2	93.6	29.2	252	35.00	
40	3600	230/460	324JP	<b>GT3433</b>	324TTFCA6012	√	\$3,122	S2	92.4	88.0/44.0	675	35.81	
	3600	575	324JP	<b>GT3533</b>	324TTFCA6013	√	\$3,122	S2	92.4	35.0	675	35.81	
	1800	230/460	324JP	<b>GT3434</b>	324TTFCA6037	√	\$3,680	S2	94.1	94.0/47.0	750	35.81	
	1800	575	324JP	<b>GT3534</b>	324TTFCA6038	√	\$3,680	S2	94.1	37.5	750	35.81	
50	3600	230/460	326JP	<b>GT3436</b>	326TTFCA6012	√	\$3,993	S2	93.0	109/54.5	725	36.99	
	3600	575	326JP	<b>GT3536</b>	326TTFCA6013	√	\$3,993	S2	93.0	43.5	725	36.99	
	1800	230/460	326JP	<b>GT3437</b>	326TTFCA6037	√	\$4,255	S2	94.5	119/59.5	775	36.99	
	1800	575	326JP	<b>GT3537</b>	326TTFCA6038	√	\$4,255	S2	94.5	47.5	775	36.99	

Catalog numbers (Cat No.) highlighted in bold blue have efficiency levels that meet EISA requirements

Blue shaded areas are Cast Iron Frames

PUMP MOTORS (FLUID HANDLING)



# Dimensions

## Definite Purpose - Close Coupled Pump Motors

Typical Close Coupled Pump Motor

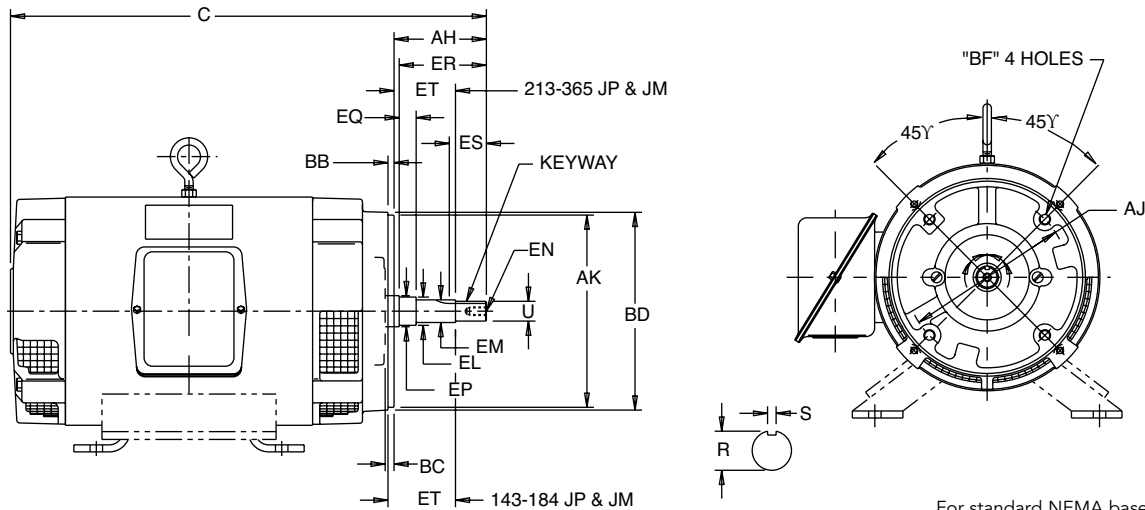

For standard NEMA base dimensions, see chart on back cover

### Dimensions for Type JM

Frame Desig.	U	AH	AJ	AK	BB	BD Max.	BF			EL	EM	EN			EP Min.	EQ	ER Min.	Keyseat			ET
							No.	Tap Size	Bolt Pen. Allow.			Tap Size	Tap Drill Depth Max.	Bolt Pen. Allow.				R	ES Min.	S	
143 & 145	0.8745	4.15	5.890	4.500	0.150	6.62	4	3/8-16	0.56	1.156	1.0000	3/8-16	1.12	0.75	1.156	0.640	4.25	0.771	1.65	0.190	2.890
182 & 184	0.8745	4.13	5.89	4.500	0.16	6.62	4	3/8-16	0.56	1.250	1.0000	3/8-16	1.12	0.75	1.250	0.640	4.25	0.771	1.65	0.190	2.890
213 & 215	0.8750	4.25	7.265	8.500	0.312	9.00	4	1/2-13	0.75	1.250	1.0000	3/8-16	1.12	0.75	1.750	0.640	4.25	0.771	1.65	0.190	2.890
254 & 256	1.2495	5.25	7.250	8.500	0.312	10.00	4	1/2-13	0.75	1.750	1.3750	1/2-13	1.50	1.00	1.750	0.640	5.25	1.112	2.53	0.252	3.015
284 & 286	1.2495	5.281	11.00	12.500	0.312	14.00	4	5/8-11	0.94	1.750	1.3750	1/2-13	1.50	1.00	2.125	0.645	5.25	1.112	2.53	0.252	3.020
324 & 326	1.2495	5.281	11.00	12.500	0.312	14.00	4	5/8-11	0.94	1.750	1.3750	1/2-13	1.50	1.00	2.125	0.645	5.25	1.112	2.53	0.252	3.020
	1.2490	5.219	11.00	12.495	0.250					1.748	1.3745				0.605		1.097	2.53	0.250	2.985	
	1.2490	5.219	11.00	12.495	0.250					1.748	1.3745				0.605		1.097	2.53	0.250	2.980	
	1.2490	5.219	11.00	12.495	0.250					1.478	1.3745				0.605		1.097	2.53	0.250	2.980	

### Dimensions for Type JP

Frame Desig.	U	AH	AJ	AK	BB	BD Max.	BF			EL	EM	EN			EP Min.	EQ	ER Min.	Keyseat			ET
							No.	Tap Size	Bolt Pen. Allow.			Tap Size	Tap Drill Depth Max.	Bolt Pen. Allow.				R	ES Min.	S	
143 & 145	0.8745	7.19	5.890	4.500	0.156	6.62	4	3/8-16	0.56	1.156	1.0000	3/8-16	1.12	0.75	1.156	1.578	7.312	0.771	1.65	0.190	5.952
182 & 184	0.8745	7.21	5.890	4.500	0.156	6.62	4	3/8-16	0.56	1.250	1.0000	3/8-16	1.12	0.75	1.250	1.548	7.312	0.771	1.65	0.190	5.922
213 & 215	1.2495	8.12	7.250	8.500	0.312	9.00	4	1/2-13	0.75	1.750	1.3750	1/2-13	1.50	1.00	1.750	2.390	8.125	1.112	2.53	0.252	5.890
254 & 256	1.2495	8.156	7.250	8.500	0.312	10.00	4	1/2-13	0.75	1.750	1.3750	1/2-13	1.50	1.00	1.750	2.360	8.125	1.097	2.53	0.250	5.860
284 & 286	1.2495	8.156	11.00	12.500	0.312	14.00	4	5/8-11	0.94	1.750	1.3750	1/2-13	1.50	1.00	2.125	2.390	8.125	1.112	2.53	0.252	5.890
324 & 326	1.2495	8.12	11.00	12.500	0.312	14.00	4	5/8-11	0.94	1.750	1.3750	1/2-13	1.50	1.00	2.125	2.360	8.125	1.097	2.53	0.250	5.860
	1.2490	8.094	11.00	12.495	0.250					1.748	1.3745				2.360		8.125	1.097	2.53	0.250	5.855
	1.2490	8.094	11.00	12.495	0.250					1.748	1.3745				2.360		8.125	1.097	2.53	0.250	5.855
	1.2490	8.12	11.00	12.495	0.250					1.748	1.3745				2.355		8.125	1.097	2.53	0.250	5.855
364 & 365	1.6245	8.12	11.00	12.500	0.312	14.00	4	5/8-11	0.94	2.125	1.7500	1/2-13	1.50	1.00	2.500	2.395	8.125	1.416	2.53	0.377	5.895
	1.6240	8.12	11.00	12.495	0.250					2.13	1.7495				2.355		8.125	1.401	2.53	0.375	5.855

PUMP MOTORS (FLUID HANDLING)

All dimensions are measured in inches. For "C" dimensions, refer to the appropriate catalog page. Certified drawings are available upon request - contact Marathon Motors for details.

# Fire Pump, Three Phase

## Dripproof, Rigid Base

### Applications:

For use on pumps designed for fire pump duty and installed per NFPA-20. These Dripproof motors are intended for installation in relatively clean and dry environments. **Fire Pump motors are not recommended for use with variable frequency drives.**



### Features:

- UL File EX5190, CSA File LR2025 and CE Mark
- Ball bearings
- 1.15 Service Factor
- Red paint on 25 HP through 200 HP
- NEMA Design B, Code G or less
- Dual voltage motors have 12 leads, suitable for wye-delta or across the line start on either voltage, or part winding start on low voltage
- Single voltage motors have 12 leads and are suitable for wye-delta, across the line, or part winding start
- Will accept C- Face kits, see Accessories section
- 230/460 and 460 Volt models rated for 50 HZ at next lower HP, 1.15 SF as noted

HP	RPM	VOLTS	FRAME	CAT. NO.	MODEL NO.	STOCK	LIST PRICE	MULT. SYMB.	NOM. EFF.	F.L. AMPS	WEIGHT	"C" DIM.	FOOT NOTES
25	3600	200/400	256T	<b>U501</b>	256TTDX4020		\$1,750	E2	91.0	66.5/33.5	126	22.32	
	3600	230/460	256T	<b>U500</b>	256TTDX4024	√	\$1,750	E2	91.0	58.0/29.0	164	22.32	68
	1800	200/400	284T	<b>U503</b>	284TTDP4047		\$1,733	E2	91.7	70/35.0	420	23.49	
	1800	230/460	284T	<b>U502</b>	284TTDP4027		\$1,733	E2	91.7	61.0/30.5	423	23.49	68
30	3600	230/460	284TS	<b>U504</b>	284TSTDP4002	√	\$2,088	E2	91.0	72.0/36.0	460	22.06	68
	3600	200/400	284TS	<b>U505</b>	284TSTDP4007		\$2,088	E2	91.0	83/41.5	460	22.06	68
	1800	200/400	286T	<b>U507</b>	286TTDP14042		\$2,016	E2	92.4	83.0/41.5	331	24.99	68
	1800	230/460	286T	<b>U506</b>	286TTDP4041		\$2,016	E2	92.4	72.0/36.0	331	24.99	68
40	3600	200/400	286TS	<b>U509</b>	286TSTDP4023	√	\$2,672	E2	91.7	108/54.0	360	23.56	
	3600	230/460	286TS	<b>U508</b>	286TSTDP4022	√	\$2,672	E2	91.7	94.0/47.0	332	23.56	68
	1800	200/400	324T	<b>U511</b>	324TTDP14049		\$2,507	E2	93.0	112/56.0	465	26.00	
	1800	230/460	324T	<b>U510</b>	324TTDP4038	√	\$2,507	E2	93.0	97.0/48.5	465	26.00	68
50	3600	200/400	324TS	<b>U513</b>	324TSTDP4007	√	\$3,176	E2	92.4	135/67.5	414	24.50	
	3600	230/460	324TS	<b>U512</b>	324TSTDP4010	√	\$3,176	E2	92.4	117/58.5	414	24.50	68
	1800	200/400	326T	<b>U515</b>	326TTDP4344		\$2,922	E2	93.0	141/70.5	515	27.50	
	1800	230/460	326T	<b>U514</b>	326TTDP4345		\$2,922	E2	93.0	123/61.5	345	27.50	68
60	3600	200/400	326TS	<b>U517</b>	326TSTDP4022	√	\$3,611	E2	93.0	155/77.5	378	26.00	
	3600	230/460	326TS	<b>U516</b>	326TSTDP4024	√	\$3,611	E2	93.0	135/67.5	378	26.00	68
	1800	200/400	326TS	<b>U521</b>	326TSTD14034		\$3,285	E2	93.6	167/83.5	418	29.50	
	1800	200/400	364TS	<b>U519</b>	364TSTDS4337		\$3,682	E2	93.6	166/83.0	699	26.50	
	1800	200/400	364T	<b>U538</b>	364TTDS14329		\$3,682	E2	93.6	166/83.0	716	28.62	
	1800	230/460	364T	<b>U520</b>	364TTDS4328		\$3,682	E2	93.6	144/72.0	716	28.62	68
	1800	230/460	364TS	<b>U518</b>	364TSTDS4332	√	\$3,682	E2	93.6	144/72.0	686	26.50	68

Catalog numbers (Cat No.) highlighted in bold blue have efficiency levels that meet EISA requirements

Blue shaded areas are Cast Iron Frames

PUMP MOTORS (FLUID HANDLING)

Continued on next page.

# Fire Pump, Three Phase

## Dripproof, Rigid Base

HP	RPM	VOLTS	FRAME	CAT. NO.	MODEL NO.	STOCK	LIST PRICE	MULT. SYMB.	NOM. EFF.	F.L. AMPS	WEIGHT	"C" DIM.	FOOT NOTES
75	3600	200/400	364TS	<b>U523</b>	364TSTDS4024	√	\$4,949	E2	93.0	210/105	713	26.50	
	3600	230/460	364TS	<b>U522</b>	364TSTDS4025	√	\$4,949	E2	93.0	183/91.5	950	26.50	68
	1800	200/400	365TS	<b>U525</b>	365TSTDS4347		\$4,485	E2	94.1	204/102	766	27.50	
	1800	230/460	365TS	<b>U524</b>	365TSTDS4332	√	\$4,485	E2	94.1	177/88.5	772	27.50	68
100	3600	200/400	365TS	<b>U527</b>	365TSTDS4303	√	\$6,501	E2	93.0	276/138	748	27.50	
	3600	200/400	365TS	Y647	365TSTDS7904	√	\$5,943	E2	91.7	274/137	690	27.50	d
	3600	230/460	365TS	<b>U526</b>	365TSTDS4025	√	\$6,501	E2	93.0	240/120	721	27.50	68
	1800	200/400	404TS	<b>U529</b>	404TSTDS4333	√	\$5,807	E2	94.1	271/136	850	29.50	
	1800	230/460	404TS	<b>U528</b>	404TSTDS4332	√	\$5,720	E2	94.1	236/118	1002	29.50	68
125	3600	200/400	404TS	<b>U531</b>	404TSTDS14008	√	\$8,087	E2	93.6	327/163	949	29.50	
	3600	230/460	404TS	<b>U530</b>	404TSTDS4017	√	\$8,087	E2	93.6	284/142	933	29.50	68
	1800	200/400	405TS	<b>U533</b>	405TSTDS4333		\$6,849	E2	94.5	336/168	1070	31.00	
	1800	230/460	405TS	<b>U532</b>	405TSTDS4332	√	\$6,849	E2	94.5	292/146	925	31.00	68
150	3600	460	405TS	<b>U534</b>	405TSTDS4006	√	\$9,838	E2	93.6	169	1004	31.00	68
	1800	460	444TS	<b>U535</b>	444TSTDS4332	√	\$9,891	E2	95.0	173	1286	34.00	68
200	3600	460	444TS	<b>U536</b>	444TSTDS4010	√	\$15,304	E2	94.5	225	1313	34.00	68
	1800	460	445TS	<b>U537</b>	445TSTDS4332	√	\$12,496	E2	95.0	233	1414	36.00	68
250	3600	460	445TS	U539	445TSTDS14007	√	\$15,937	E2	94.5	279	1608	36.00	68
	1800	460	445TS	U540	445TSTDS14051	√	\$13,790	E2	95.4	287	1642	36.00	68
300	3600	460	447TS	H178	447TSTDN7001	√	\$16,918	E6	95.0	332	1940	39.50	F,25,68
	1800	460	447TS	H812	447TSTDN7026	√	\$15,976	E6	95.4	345	1994	39.50	F,25,68
350	3600	460	447TS	H193	447TSTDN7003	√	\$19,379	E6	95.0	385	2013	39.50	F,25,68
	1800	460	447TS	H813	447TSTDN7027	√	\$17,363	E6	95.4	400	2064	39.50	F,25,68
400	3600	460	447TS	H817	447TSTDN7005	√	\$22,049	E6	95.4	440	2150	39.50	F,25,68
	1800	460	447TS	H814	447TSTDN7028	√	\$20,152	E6	95.4	450	2220	39.50	F,25
450	3600	460	449TS	H818	449TSTDN7001	√	\$23,550	E6	95.8	495	2544	44.50	F,TS,25,68
	1800	460	449TS	H815A	449TSTDN14033		\$23,169	E6	95.8	505	2937	44.50	F,TS,25
500	3600	460	449TS	H819A	449TSTDN14005	√	\$28,591	E6	95.8	545	2892	44.50	F,TS,25
	1800	460	449TS	H816	449TSTDN7027		\$23,599	E6	95.8	560	2695	44.50	F,TS,25

Catalog numbers (Cat No.) highlighted in bold blue have efficiency levels that meet EISA requirements

Blue shaded areas are Cast Iron Frames

# Fire Pump, Three Phase

## TEFC, Rigid Base, EPAct



### Applications:

For use on pumps designed for fire pump duty and installed per NFPA-20.

**Fire Pump motors are not recommended for use with variable frequency drives.**

### Features:

- UL File EX5190, CSA File LR2025 and CE Mark
- Ball bearings
- 1.15 Service Factor
- Red paint exterior
- NEMA Design B, Code G or less
- Dual voltage motors have 12 leads, suitable for wye-delta or across the line start on either voltage, or part winding start on low voltage
- Single voltage motors have 12 leads and are suitable for wye-delta, across the line, or part winding start
- Will accept C- Face kits, see Accessories section
- 230/460 and 460 Volt models rated for 50 HZ at next lower HP, 1.15 SF
- For special designs, contact district sales office near you

HP	RPM	VOLTS	FRAME	CAT. NO.	LIST PRICE	MULT. SYMB.	NOM. EFF.	F.L. AMPS	WEIGHT	"C" DIM.	FOOT NOTES
3	3600	200/400	182T	<b>Y1800</b>	\$901	E2	85.5	8.5/4.25	84	15.87	
	3600	230/460	182T	<b>Y1600</b>	\$901	E2	85.5	7.4/3.7	84	15.87	
	1800	200/400	182T	<b>Y1801</b>	\$662	E2	87.5	9.9/5.0	90	15.87	
	1800	230/460	182T	<b>Y1601</b>	\$662	E2	87.5	8.6/4.3	90	15.87	
5	3600	200/400	184T	<b>Y1802</b>	\$1,037	E2	87.5	14.0/7.0	108	15.87	
	3600	230/460	184T	<b>Y1602</b>	\$1,037	E2	87.5	12.2/6.1	108	15.87	
	1800	200/400	184T	<b>Y1803</b>	\$764	E2	87.5	15.0/7.5	123	15.87	
	1800	230/460	184T	<b>Y1603</b>	\$764	E2	87.5	13.0/6.5	123	15.87	
7.5	3600	200/400	213T	<b>Y1804</b>	\$1,312	E2	88.5	21.9/11.0	188	18.20	
	3600	230/460	213T	<b>Y1604</b>	\$1,312	E2	88.5	19.0/9.5	188	18.20	
	1800	200/400	213T	<b>Y1805</b>	\$975	E2	89.5	23.0/11.5	194	18.20	
	1800	230/460	213T	<b>Y1605</b>	\$975	E2	89.5	20.0/10.0	194	19.63	
10	3600	200/400	215T	<b>Y1806</b>	\$1,532	E2	89.5	27.6/13.8	217	19.63	
	3600	230/460	215T	<b>Y1606</b>	\$1,532	E2	89.5	24.0/12.0	217	19.63	
	1800	200/400	215T	<b>Y1807</b>	\$1,186	E2	89.5	28.8/14.4	227	22.63	
	1800	230/460	215T	<b>Y1607</b>	\$1,186	E2	89.5	25.0/12.5	227	22.63	
15	3600	200/400	254T	<b>Y1808</b>	\$2,160	E2	90.2	40.3/20.1	370	23.69	
	3600	230/460	254T	<b>Y1608</b>	\$2,160	E2	90.2	35.0/17.5	370	23.69	
	1800	200/400	254T	<b>Y1809</b>	\$1,749	E2	91.0	44.9/22.4	365	23.52	
	1800	230/460	254T	<b>Y1609</b>	\$1,749	E2	91.0	39.0/19.5	365	23.52	
20	3600	200/400	256T	<b>Y1810</b>	\$2,610	E2	90.2	53.8/26.9	334	25.27	
	3600	230/460	256T	<b>Y1610</b>	\$2,610	E2	90.2	46.8/23.4	334	25.27	
	1800	200/400	256T	<b>Y1811</b>	\$2,072	E2	91.0	57.5/28.75	420	25.27	
	1800	230/460	256T	<b>Y1611</b>	\$2,072	E2	91.0	50.0/25.0	420	25.27	
25	3600	200/400	284TS	<b>Y1812</b>	\$2,450	E2	91.0	67.9/33.9	384	24.89	
	3600	230/460	284TS	<b>Y1612</b>	\$2,450	E2	91.0	59.0/29.5	384	24.89	
	1800	200/400	284T	<b>Y1813</b>	\$2,253	E2	92.4	70.2/35.1	440	26.27	
	1800	230/460	284T	<b>Y1613</b>	\$2,253	E2	92.4	61.0/30.5	440	26.27	

Catalog numbers (Cat No.) highlighted in bold blue have efficiency levels that meet EISA requirements

Continued on next page.

# Fire Pump, Three Phase

## TEFC, Rigid Base, EPAct

HP	RPM	VOLTS	FRAME	CAT. NO.	LIST PRICE	MULT. SYMB.	NOM. EFF.	F.L. AMPS	WEIGHT	"C" DIM.	FOOT NOTES
30	3600	200/400	286TS	<b>Y1814</b>	\$2,714	E2	91.0	80.5/40.3	428	26.47	
	3600	230/460	286TS	<b>Y1614</b>	\$2,714	E2	91.0	70.0/35.0	428	26.47	
	1800	200/400	286T	<b>Y1815</b>	\$2,621	E2	92.4	82.8/41.4	494	27.84	
40	1800	230/460	286T	<b>Y1615</b>	\$2,621	E2	92.4	72.0/36.0	494	27.84	
	3600	200/400	324TS	<b>Y1816</b>	\$3,474	E2	91.7	106/53.0	520	27.47	
	3600	230/460	324TS	<b>Y1616</b>	\$3,474	E2	91.7	92.0/46.0	520	27.47	
	1800	200/400	324TS	<b>Y1817</b>	\$3,259	E2	93.0	115/58.0	575	27.37	
	1800	230/460	324TS	<b>Y1617</b>	\$3,259	E2	93.0	100/50.0	575	27.37	
	1800	200/400	324T	<b>Y1818</b>	\$3,259	E2	93.0	115/58.0	575	28.97	
50	1800	230/460	324T	<b>Y1618</b>	\$3,259	E2	93.0	100/50.0	575	28.97	
	3600	200/400	326TS	<b>Y1819</b>	\$4,129	E2	92.4	129/64.0	540	28.97	
	3600	230/460	326TS	<b>Y1619</b>	\$4,129	E2	92.4	112/56.0	540	28.97	
	1800	200/400	326TS	<b>Y1820</b>	\$3,799	E2	93.0	140/70.0	675	28.87	
	1800	230/460	326TS	<b>Y1620</b>	\$3,799	E2	93.0	122/61.0	675	28.87	
	1800	200/400	326T	<b>Y1821</b>	\$3,799	E2	93.0	140/70.0	675	30.37	
60	1800	230/460	326T	<b>Y1621</b>	\$3,799	E2	93.0	122/61.0	675	31.87	
	3600	200/400	364TS	<b>Y1822</b>	\$4,694	E2	93.0	159/79.0	875	29.38	
	3600	230/460	364TS	<b>Y1622</b>	\$4,694	E2	93.0	138/69.0	875	29.38	
	1800	200/400	364TS	<b>Y1823</b>	\$4,787	E2	93.6	163/82.0	975	29.38	
	1800	230/460	364TS	<b>Y1623</b>	\$4,787	E2	93.6	142/71.0	975	29.38	
	1800	200/400	364T	<b>Y1824</b>	\$4,787	E2	93.6	163/82.0	975	31.50	
75	1800	230/460	364T	<b>Y1624</b>	\$4,787	E2	93.6	142/71.0	975	31.50	
	3600	200/400	365TS	<b>Y1825</b>	\$6,434	E2	93.0	198/99.0	1000	30.38	
	3600	230/460	365TS	<b>Y1625</b>	\$6,434	E2	93.0	172/86.0	1000	30.38	
	1800	200/400	365TS	<b>Y1826</b>	\$5,831	E2	94.1	202/101	1025	30.38	
	1800	230/460	365TS	<b>Y1626</b>	\$5,831	E2	94.1	176/88.0	1025	30.38	
	1800	200/400	365T	<b>Y1827</b>	\$5,831	E2	94.1	202/101	1025	32.50	
100	1800	230/460	365T	<b>Y1627</b>	\$5,831	E2	94.1	176/88.0	1025	32.50	
	3600	200/400	405TS	<b>Y1828</b>	\$8,451	E2	93.6	258/129	1239	34.12	
	3600	230/460	405TS	<b>Y1628</b>	\$8,451	E2	93.6	224/112	1239	34.12	
	1800	200/400	405TS	<b>Y1829</b>	\$7,549	E2	94.5	172/86.0	1267	34.12	
	1800	230/460	405TS	<b>Y1629</b>	\$7,436	E2	94.5	224/112	1267	34.12	
	1800	200/400	405T	<b>Y1830</b>	\$7,549	E2	94.5	258/129	1267	37.12	
125	1800	230/460	405T	<b>Y1630</b>	\$7,436	E2	94.5	224/112	1267	37.12	
	3600	400	444TS	<b>Y1831</b>	\$10,513	E2	94.5	159	1750	37.50	
	3600	460	444TS	<b>Y1631</b>	\$10,513	E2	94.5	136	1750	37.50	
	1800	400	444TS	<b>Y1832</b>	\$8,904	E2	94.5	163	1805	37.60	
	1800	460	444TS	<b>Y1632</b>	\$8,904	E2	94.5	142	1805	37.60	
	1800	400	444T	<b>Y1833</b>	\$8,904	E2	94.5	167	1805	43.35	
150	1800	460	444T	<b>Y1633</b>	\$8,904	E2	94.5	145	1805	43.35	
	3600	400	445TS	<b>Y1834</b>	\$12,789	E2	94.5	190	2187	39.44	
	3600	460	445TS	<b>Y1634</b>	\$12,789	E2	94.5	165	2187	39.44	
	1800	400	445TS	<b>Y1835</b>	\$12,858	E2	95.0	196	2116	39.60	

Catalog numbers (Cat No.) highlighted in bold blue have efficiency levels that meet EISA requirements

Continued on next page.

# Fire Pump, Three Phase

## TEFC, Rigid Base, EPAct

HP	RPM	VOLTS	FRAME	CAT. NO.	LIST PRICE	MULT. SYMB.	NOM. EFF.	F.L. AMPS	WEIGHT	"C" DIM.	FOOT NOTES
150	1800	460	445TS	<b>Y1635</b>	\$12,858	E2	95.0	170	2116	39.60	
	1800	400	445T	<b>Y1836</b>	\$12,858	E2	95.0	196	2116	43.35	
	1800	460	445T	<b>Y1636</b>	\$12,858	E2	95.0	170	2116	43.35	
200	3600	400	445TS	<b>Y1837</b>	\$19,895	E2	95.0	255	2300	39.44	
	3600	460	445TS	<b>Y1637</b>	\$19,895	E2	95.0	222	2300	39.44	
	1800	400	445TS	<b>Y1838</b>	\$16,245	E2	95.0	231	2311	39.44	
	1800	460	445TS	<b>Y1638</b>	\$16,245	E2	95.0	201	2311	39.44	
	1800	400	445T	<b>Y1839</b>	\$16,245	E2	95.0	258	2311	43.35	
	1800	460	445T	<b>Y1639</b>	\$16,245	E2	95.0	224	2311	43.35	
	1800	400	449TS	<b>Y1840</b>	\$20,718	E2	95.4	316	2700	47.88	
250	3600	460	449TS	<b>Y1640</b>	\$20,718	E2	95.4	275	2700	47.88	
	1800	400	449TS	<b>Y1841</b>	\$17,927	E2	95.0	375	2600	48.09	
	1800	460	449TS	<b>Y1641</b>	\$17,927	E2	95.0	326	2600	48.09	
	1800	400	449T	<b>Y1842</b>	\$17,927	E2	95.0	334	2600	51.85	
	1800	460	449T	<b>Y1642</b>	\$17,927	E2	95.0	290	2600	51.85	
	3600	400	449TS	<b>Y1843</b>	\$21,993	E2	95.4	380	2850	47.88	
	3600	460	449TS	<b>Y1643</b>	\$21,993	E2	95.4	330	2850	47.88	
300	1800	400	449TS	<b>Y1844</b>	\$20,769	E2	95.4	385	3041	48.09	
	1800	460	449TS	<b>Y1644</b>	\$20,769	E2	95.4	335	3041	48.09	
	1800	400	449T	<b>Y1845</b>	\$20,769	E2	95.4	385	3041	51.86	
	1800	460	449T	<b>Y1645</b>	\$20,769	E2	95.4	335	3041	51.86	
	3600	400	449TS	<b>Y1846</b>	\$25,193	E2	95.4	437	3064	47.88	
	3600	460	449TS	<b>Y1646</b>	\$25,193	E2	95.4	380	3064	47.88	
	1800	400	449TS	<b>Y1847</b>	\$22,572	E2	95.4	460	3202	48.09	
350	1800	460	449TS	<b>Y1647</b>	\$22,572	E2	95.4	400	3202	48.09	
	1800	400	449T	<b>Y1848</b>	\$22,572	E2	95.4	460	3202	51.88	
	1800	460	449T	<b>Y1648</b>	\$22,572	E2	95.4	400	3202	51.88	
	3600	400	5011S	<b>Y1849</b>	\$46,143	E2	95.4	467	5500	67.19	
	3600	460	5011S	<b>Y1649</b>	\$46,143	E2	95.4	432	5500	67.19	
	1800	400	5011L	<b>Y1850</b>	\$40,124	E2	95.4	515	5800	67.19	
	1800	460	5011L	<b>Y1650</b>	\$40,124	E2	95.4	448	5800	67.19	
400	3600	400	5011L	<b>Y1851</b>	\$47,433	E2	95.4	592	5845	67.19	
	3600	460	5011L	<b>Y1651</b>	\$47,433	E2	95.4	515	5845	67.19	
	1800	400	5011L	<b>Y1852</b>	\$41,247	E2	95.4	569	5942	67.19	
450	1800	460	5011L	<b>Y1652</b>	\$41,247	E2	95.4	495	5942	67.19	

Catalog numbers (Cat No.) highlighted in bold blue have efficiency levels that meet EISA requirements

# Vertical Solid Shaft P-Base

## Three Phase, Dripproof

### Applications:

For use on: Vertical end suction, short couple, centrifugal, non-clog, mix flow, turbine, and propeller pumps. HP type shafts, per NEMA MG-1 18.625. HPH and TCV type shafts, single phase, and other modifications such as adding screens are also available through special order. Contact Marathon Motors for more information.

### Features:

- Normal and Medium thrust
- EPAct and NEMA Premium efficiencies
- Ball bearings and angular contact bearings for medium thrust applications
- Class B insulation
- 1.15 Service Factor
- Suitable for 230 volt part winding start through 100 HP (dual voltage motors)
- Heavy duty lifting lugs
- Drip cover/canopy cap included
- UL Recognized and CSA Certified
- UL Listed for Fire Pump applications (except as noted)

EPAct Efficient, Normal Thrust															
HP	RPM	VOLTS	FRAME	CAT. NO.	MODEL NO.	STOCK	LIST PRICE	MULT. SYMB.	NOM. EFF.	F.L. AMPS	WEIGHT	DOWN THRUST	BASE DIA	"C" DIM.	FOOT NOTES
3	1800	230/460	182HP	<b>M801A</b>	182TTDR14027		\$870	S5	86.5	9.3/4.7	83	390	9.88	17.18	98
	1200	230/460	213HP	<b>M802A</b>	213TTDW14084		\$1,357	S5	86.5	8.4/4.2	104	560	9.88	20.30	98
5	3600	230/460	182HP	<b>M803A</b>	182TTDR14026		\$1,393	S5	87.5	13.0/6.5	87	310	9.88	17.68	98
	1800	230/460	184HP	<b>M804A</b>	184TTDR4173		\$1,338	S5	87.5	13.2/6.6	168	490	9.88	17.18	98
7 1/2	1200	230/460	215HP	<b>M805A</b>	215TTDW14087		\$1,916	S5	87.5	14.2/7.1	138	650	9.88	21.55	98
	1800	230/460	213HP	<b>M807A</b>	213TTDW14054		\$1,672	S5	88.5	19.2/9.6	335	560	9.88	20.30	98
10	1200	230/460	254HP	<b>M808A</b>	254TTDX14088		\$2,281	S5	88.5	21.4/10.7	210	720	9.88	24.30	
	1800	230/460	215HP	<b>M810A</b>	215TTDW4071		\$1,878	S5	89.5	25.0/12.5	120	560	9.88	20.30	98
15	1200	230/460	256HP	<b>M811A</b>	256TTDX4094		\$2,576	S5	90.2	28.0/14.0	238	720	9.88	24.30	
	3600	230/460	215HP	<b>M813A</b>	215TTDW14018		\$2,184	S5	89.5	34.0/17.0	80	520	9.88	21.55	98
20	1800	230/460	254HP	<b>M814A</b>	254TTDX14064		\$2,245	S5	91.0	38.5/19.2	227	640	9.88	24.30	
	1200	230/460	284HP	<b>M815A</b>	284TTDR14082		\$3,002	S5	90.2	39.0/19.5	486	800	12.55	27.06	98
25	1200	230/460	284HP	<b>M818A</b>	256TTDX14039		\$2,561	S5	91.0	50.0/25.0	241	640	9.88	24.30	
	900	230/460	286HP	<b>M819A</b>	286TTDR14081		\$3,652	S5	91.0	53.0/26.5	562	800	12.55	29.56	98
30	900	230/460	324HP	<b>M820A</b>	324TTDR14104		\$4,109	S5	90.2	60.0/30.0	465	1100	16.38	30.56	98
	3600	230/460	256HP	<b>M821A</b>	256TTDX4310		\$2,525	S5	91.0	58.0/29.0	225	520	9.88	24.30	
35	1800	230/460	284HP	<b>M822A</b>	286TTDR14046		\$2,854	S5	91.7	66.0/33.0	289	700	12.55	27.06	98
	1200	230/460	324HP	<b>M823A</b>	324TTDR14080		\$3,968	S5	91.7	66.0/33.0	460	1000	16.38	30.06	98
40	900	230/460	326HP	<b>M824A</b>	326TTDR14103		\$4,733	S5	90.2	73.0/36.5	611	1100	16.38	30.56	98
	3600	230/460	284HP	<b>M825A</b>	284TTDR14011		\$2,764	S5	91.0	72.0/36.0	292	550	12.55	27.06	98
45	1800	230/460	286HP	<b>M826A</b>	286TTDR14042		\$3,210	S5	92.4	72.0/36.0	520	700	12.55	29.56	98
	900	230/460	364HP	<b>M828A</b>	364TTDS14104		\$5,311	S5	91.0	82.0/41.0	700	1100	16.5	29.00	
50	3600	230/460	286HP	<b>M829</b>	286TTDR17009		\$3,613	S5	91.7	94.0/47.0	347	550	12.55	28.56	98
	1800	230/460	324HP	<b>M830A</b>	324TTDR14049		\$3,551	S5	93.0	97.0/48.5	480	800	16.38	30.06	98
55	1200	230/460	364HP	<b>M831A</b>	364TTDS14081		\$5,535	S5	93.0	105/52.5	772	1000	16.5	29.00	
	900	230/460	365HP	<b>M832A</b>	365TTDS14101		\$6,402	S5	91.0	106/53.0	770	1100	16.5	29.00	
60	3600	230/460	324HP	<b>M833A</b>	324TTDR14010		\$4,167	S5	92.4	117/58.5	510	600	16.38	29.56	98
	1800	230/460	326HP	<b>M834A</b>	326TTDR14034		\$4,215	S5	93.0	123/61.5	386	800	16.38	30.56	98
65	1200	230/460	365HP	<b>M835A</b>	365TTDS14082		\$6,530	S5	93.0	130/65.0	725	1000	16.5	29.00	
	900	460	404HP	<b>M836A</b>	404TTDS14102		\$7,297	S5	91.7	70.0	790	1400	16.5	31.75	

VERTICAL P-BASE

Catalog numbers (Cat No.) highlighted in bold blue have efficiency levels that meet EISA requirements

Blue shaded areas are Cast Iron Frames

Continued on next page.

# Vertical Solid Shaft P-Base

## Three Phase, DripProof

EPAct Efficient, Normal Thrust															
HP	RPM	VOLTS	FRAME	CAT. NO.	MODEL NO.	STOCK	LIST PRICE	MULT. SYMB.	NOM. EFF.	F.L. AMPS	WEIGHT	DOWN THRUST	BASE DIA	"C" DIM.	FOOT NOTES
60	3600	230/460	326HP	<b>M837A</b>	326TTDR14010		\$4,661	S5	93.0	135/67.5	589	600	16.38	30.56	98
	1800	230/460	364HP	<b>M838A</b>	364TTDR14032		\$4,868	S5	93.6	145/72.5	587	800	16.38	34.19	98
	1200	230/460	404HP	<b>M839A</b>	404TTDS14081		\$7,453	S5	93.6	144/72.0	1049	1200	16.50	31.75	
	900	230/460	405HP	<b>M840</b>	405TTDS7124		\$8,415	S5	92.4	166/83.0	1077	1400	16.50	31.75	
75	3600	230/460	364HP	<b>M841A</b>	364TTDS14011		\$5,832	S5	93.0	183/91.5	733	600	16.50	29.00	
	1800	230/460	365HP	<b>M842A</b>	365TTDS4328		\$5,926	S5	94.1	179/89.5	810	800	16.50	29.00	
	1200	230/460	405HP	<b>M843A</b>	405TTDS4376		\$8,767	S5	93.6	176/88.0	1097	1200	16.50	31.75	
	900	460	444HP	<b>M844A</b>	444TTDS14101		\$9,651	S5	93.6	95.0	1210	1600	16.38	36.02	
100	3600	230/460	365HP	<b>M845A</b>	365TTDS14009		\$7,860	S5	93.0	240/120	762	600	16.50	29.00	
	1800	230/460	404HP	<b>M846A</b>	404TTDS4359		\$7,487	S5	94.1	236/118	1100	900	16.50	31.75	
	1200	460	444HP	<b>M847A</b>	444TTDS14086		\$10,881	S5	94.1	118	1317	1400	16.38	36.02	
	900	460	445HP	<b>M848</b>	445TTDS7121		\$12,948	S5	93.6	128	1504	1600	16.38	36.02	
125	3600	460	404HP	<b>M849A</b>	404TTDS14005		\$9,876	S5	93.6	142	1009	600	16.50	31.75	
	1800	460	405HP	<b>M850A</b>	405TTDS14067		\$9,043	S5	94.5	147	1142	900	16.50	31.75	
	1200	460	445HP	<b>M851A</b>	445TTDS14087		\$12,920	S5	94.1	147	1385	1400	16.38	36.02	
	900	460	505P	<b>M852</b>	505UTDS805		\$17,208	S5	93.6	168	1976	1600	20.00	38.75	98
150	3600	460	405HP	<b>M853A</b>	405TTDS14003		\$11,998	S5	93.6	169	1071	600	16.50	31.75	
	1800	460	444HP	<b>M854A</b>	444TTDS14057		\$10,849	S5	95.0	176	1240	1000	16.38	36.02	
	1200	460	445HP	<b>M855A</b>	445TTDS17084		\$15,604	S5	94.5	178	1498	1400	16.38	36.02	
	900	460	505P	<b>M856</b>	505UTDS819		\$21,330	S5	93.6	191	2148	1600	20.00	38.75	98
200	3600	460	444HP	<b>M857A</b>	444TTDS14003		\$16,398	S5	94.5	225	1357	600	16.38	36.02	
	1800	460	445HP	<b>M858A</b>	445TTDS14063		\$14,744	S5	95.0	233	1395	1000	16.38	36.02	
	1200	460	505P	<b>M859A</b>	505UTDS14077		\$22,807	S5	94.5	240	2145	1400	20.00	38.75	98
	900	460	505P	<b>M860</b>	505UTDS5820		\$24,004	S5	93.6	268	1250	1600	20.00	38.75	98
250	3600	460	445HP	<b>M861A</b>	445TTDS14003		\$17,555	S5	94.5	279	1520	600	16.38	36.02	
	1800	460	445HP	<b>M862A</b>	445TTDS14062		\$15,584	S5	95.4	286	1550	1000	16.38	36.02	
	1200	460	505P	<b>M863A</b>	505UTDS3999		\$24,323	S5	95.4	295	2318	1400	20.00	38.75	98
	900	460	508P	<b>M864</b>	---		\$29,108	S5	94.5	308		1600	20.00	45.75	98
300	1800	460	505P	<b>M866A</b>	---		\$18,771	S5	95.4	340		1000	20.00	38.75	98
	1200	460	508P	<b>M867A</b>	---		\$28,052	S5	95.4	342		1400	20.00	45.75	98
	900	460	508P	M868	---		\$34,426	S5	93.6	375		1600	20.00	45.75	NE,98
350	3600	460	505P	<b>M869A</b>	---		\$26,619	S5	95.0	378		600	20.00	38.75	98
	1800	460	505P	<b>M870</b>	---		\$21,824	S5	95.4	402		1000	20.00	38.75	98
	1200	460	508P	<b>M871A</b>	---		\$32,512	S5	95.4	400		1400	20.00	45.75	98
400	1800	460	505P	<b>M873</b>	---		\$26,188	S5	95.4	455		1000	20.00	38.75	98
	1200	460	508P	M874	---		\$37,339	S5	95.0	460		1400	20.00	45.75	NE,98

NEMA Premium Efficient, Normal Thrust															
20	3600	230/460	256HP	<b>M717</b>			\$2,856	S5	91.0	47.0/23.5	326	640	9.88	24.30	
	1800	230/460	256HP	<b>M718</b>	256TTDN16053		\$3,252	S5	93.0	48.0/24.0	452	640	16.39	29.62	
	1200	230/460	286HP	<b>M719</b>			\$4,638	S5	92.4	53.0/26.5	743	800	16.38	29.56	
25	3600	230/460	256HP	<b>M721</b>			\$3,207	S5	91.7	58.0/29.0	357	520	9.88	24.30	
	1800	230/460	256HP	<b>M722</b>	256TTDN16011		\$3,625	S5	93.6	58.0/29.0	449	700	16.39	29.62	
	1200	230/460	286HP	<b>M723</b>			\$5,039	S5	93.0	66.0/33.0	581	1000	16.38	30.06	
75	3600	230/460	364HP	<b>M741</b>			\$7,406	S5	93.6	183/91.5	733	600	16.50	29.00	
	1800	230/460	365HP	<b>M742</b>	365TTDS16072		\$7,527	S5	95.0	174/87.0	800	800	16.50	33.65	
	1200	230/460	405HP	<b>M743</b>			\$11,134	S5	94.5	176/88.0	1097	1200	16.50	31.75	
125	3600	460	404HP	<b>M749</b>			\$12,543	S5	94.1	142	1009	600	16.50	31.75	
	1800	460	405HP	<b>M750</b>	405TTDS16070		\$11,484	S5	95.4	141	1142	900	16.38	35.64	

Catalog numbers (Cat No.) highlighted in bold blue have efficiency levels that meet EISA requirements

Blue shaded areas are Cast Iron Frames

Continued on next page.

PUMP MOTORS (FLUID HANDLING)



# Vertical Solid Shaft P-Base

## Three Phase, Dripproof

NEMA Premium Efficient, Medium Thrust													
HP	RPM	VOLTS	FRAME	CAT. NO.	LIST PRICE	MULT. SYMB.	NOM. EFF.	F.L. AMPS	WEIGHT	DOWN THRUST	BASE DIA	"C" DIM.	FOOT NOTES
20	3600	230/460	256HP	<b>M1420</b>	\$4,429	S5	91.0	47.0/23.5	186	1950	9.88	28.26	
	1800	230/460	256HP	<b>M1421</b>	\$5,429	S5	93.0	50.0/25.0	241	2400	9.88	24.30	
	1200	230/460	286HP	<b>M1422</b>	\$7,742	S5	92.4	53.0/26.5	562	3000	12.55	29.56	
	900	230/460	324HP	M1423	\$8,710	S5	90.2	60.0/30.0	465	4125	16.38	30.56	NE
25	3600	230/460	256HP	<b>M1424</b>	\$5,353	S5	91.7	58.0/29.0	225	1950	9.88	24.30	
	1800	230/460	324HP	<b>M1425</b>	\$6,051	S5	93.6	66.0/33.0	289	2625	12.55	27.06	
	1200	230/460	324HP	<b>M1426</b>	\$8,412	S5	93.0	66.0/33.0	460	3750	16.38	30.06	
	900	230/460	326HP	M1427	\$10,034	S5	90.2	73.0/36.5	611	4125	16.38	30.56	NE
30	3600	230/460	284HP	<b>M1428</b>	\$5,859	S5	91.7	72.0/36.0	292	2063	12.55	27.06	
	1800	230/460	286HP	<b>M1429</b>	\$6,805	S5	94.1	72.0/36.0	520	2625	12.55	29.56	
	1200	230/460	326HP	<b>M1430</b>	\$9,303	S5	93.6	76.0/38.0	788	3750	16.38	35.62	
	900	230/460	364HP	M1431	\$11,258	S5	91.0	82.0/41.0	700	4125	16.5	29.00	NE
40	3600	230/460	286HP	<b>M1432</b>	\$7,660	S5	92.4	94.0/47.0	347	2063	12.55	28.56	
	1800	230/460	324HP	<b>M1433</b>	\$7,528	S5	94.1	97.0/48.5	480	3000	16.38	30.06	
	1200	230/460	364HP	<b>M1434</b>	\$11,735	S5	94.1	105/52.5	772	3750	16.5	29.00	
	900	230/460	365HP	M1435	\$13,571	S5	91.0	106/53.0	770	4125	16.5	29.00	NE
50	3600	230/460	324HP	<b>M1436</b>	\$8,833	S5	93.0	117/58.5	510	2250	16.38	29.56	
	1800	230/460	326HP	<b>M1437</b>	\$8,936	S5	94.5	123/61.5	386	3000	16.38	30.56	
	1200	230/460	365HP	<b>M1438</b>	\$13,843	S5	94.1	130/65.0	725	3750	16.5	29.00	
	900	230/460	404HP	M1439	\$15,470	S5	91.7	140/70.0	790	5250	16.5	31.75	NE
60	3600	230/460	364HP	<b>M1440</b>	\$4,661	S5	93.6	135/67.5	589	2250	16.38	30.56	
	1800	230/460	364HP	<b>M1441</b>	\$4,868	S5	95.0	145/72.5	587	3000	16.38	34.19	
	1200	460	404HP	<b>M1442</b>	\$7,453	S5	94.5	72.0	1049	4500	16.50	31.75	
	900	460	405HP	M1443	\$8,415	S5	92.4	83.0	1077	5250	16.50	31.75	NE
75	3600	230/460	364HP	<b>M1444</b>	\$5,832	S5	93.6	183/91.5	733	2250	16.50	29.00	
	1800	230/460	365HP	<b>M1445</b>	\$5,926	S5	95.0	179/89.5	810	3000	16.50	29.00	
	1200	460	444HP	<b>M1446</b>	\$8,767	S5	94.5	88.0	1097	4500	16.50	31.75	
	900	460	444HP	M1447	\$9,651	S5	93.6	95.0	1210	6000	16.38	36.02	NE
100	3600	230/406	365HP	<b>M1448</b>	\$7,860	S5	93.6	240/120	762	2250	16.50	29.00	
	1800	230/460	404HP	<b>M1449</b>	\$7,487	S5	95.4	230/118	1100	3375	16.50	31.75	
	1200	460	444HP	<b>M1450</b>	\$10,881	S5	95.0	118	1317	5250	16.38	36.02	
	900	460	445HP	M1451	\$12,948	S5	93.6	128	1504	6000	16.38	36.02	NE
125	3600	460	404HP	<b>M1452</b>	\$9,876	S5	94.1	142	1009	2250	16.50	31.75	
	1800	460	405HP	<b>M1453</b>	\$9,043	S5	95.4	147	1142	3375	16.50	31.75	
	1200	460	445HP	<b>M1454</b>	\$12,920	S5	95.0	147	1385	5250	16.38	36.02	
	900	460	505P	M1455	\$17,208	S5	93.6	168	1976	6000	20.00	38.75	NE,98
150	3600	460	405HP	<b>M1456</b>	\$11,998	S5	94.1	169	1071	2250	16.50	31.75	
	1800	460	444HP	<b>M1457</b>	\$10,849	S5	95.8	176	1240	3750	16.38	36.02	
	1200	460	445HP	<b>M1458</b>	\$15,604	S5	95.4	178	1498	5250	16.38	36.02	
	900	460	505P	M1459	\$21,330	S5	93.6	191	2148	6000	20.00	38.75	NE,98
200	3600	460	444HP	<b>M1460</b>	\$16,398	S5	95.0	225	1357	2250	16.38	36.02	
	1800	460	445HP	<b>M1461</b>	\$14,744	S5	95.8	233	1395	3750	16.38	36.02	
	1200	460	505P	<b>M1462</b>	\$22,807	S5	95.4	240	2145	5250	20.00	38.75	98
	900	460	505P	M1463	\$24,004	S5	93.6	268	1250	6000	20.00	38.75	NE,98

Catalog numbers (Cat No.) highlighted in bold blue have efficiency levels that meet EISA requirements

Blue shaded areas are Cast Iron Frames

PUMP MOTORS (FLUID HANDLING)

Continued on next page.

# Vertical Solid Shaft P-Base

## Three Phase, Dripproof

NEMA Premium Efficient, Medium Thrust													
HP	RPM	VOLTS	FRAME	CAT. NO.	LIST PRICE	MULT. SYMB.	NOM. EFF.	F.L. AMPS	WEIGHT	DOWN THRUST	BASE DIA	"C" DIM.	FOOT NOTES
250	3600	460	445HP	<b>M1464</b>	\$17,555	S5	95.0	279	1520	2250	16.38	36.02	
	1800	460	445HP	<b>M1465</b>	\$15,584	S5	95.8	286	1550	3750	16.38	36.02	
	1200	460	505P	<b>M1466</b>	\$24,323	S5	95.4	295	2318	5250	20.00	38.75	98
	900	460	508P	M1467	\$29,108	S5	94.5	308	1562	6000	20.00	45.75	NE,98
300	3600	460	445HP	<b>M1468</b>	\$20,567	S5	95.4	362	1900	2250	16.38	36.02	
	1800	460	505P	<b>M1469</b>	\$18,771	S5	95.8	340	1937	3750	20.00	38.75	98
	1200	460	508P	<b>M1470</b>	\$28,052	S5	95.4	342	2877	5250	20.00	45.75	98
	900	460	508P	M1471	\$34,426	S5	94.1	375	1988	6000	20.00	45.75	NE,98
350	3600	460	505P	<b>M1472</b>	\$26,619	S5	95.4	378	2375	2250	20.00	38.75	98
	1800	460	505P	<b>M1473</b>	\$21,824	S5	95.8	402	2421	3750	20.00	38.75	98
	1200	460	508P	<b>M1474</b>	\$32,512	S5	95.4	400	3596	5250	20.00	45.75	98
	900	460	508P	M1475	\$37,456	S5	94.1	422	2485	6000	20.00	45.75	NE,98
400	3600	460	505P	<b>M1476</b>	\$30,122	S5	95.8	491	2969	2250	20.00	38.75	98
	1800	460	505P	<b>M1477</b>	\$26,188	S5	95.8	455	3027	3750	20.00	38.75	98
	1200	460	508P	<b>M1478</b>	\$37,339	S5	95.8	460	4495	5250	20.00	45.75	98
	900	460	508P	M1479	\$42,556	S5	94.1	489	3106	6000	20.00	45.75	NE,98
500	3600	460	508P	<b>M1480</b>	\$35,766	S5	95.8	571	3711	2250	20.00	45.75	98
	1800	460	508P	<b>M1481</b>	\$31,224	S5	96.2	521	3783	3750	20.00	45.75	98
	1200	460	508P	<b>M1482</b>	\$41,990	S5	96.2	563	5619	5250	20.00	45.75	98
	900	460	508P	M1483	\$47,555	S5	94.1	591	3883	6000	20.00	45.75	NE,98

Catalog numbers (Cat No.) highlighted in bold blue have efficiency levels that meet EISA requirements

Blue shaded areas are Cast Iron Frames

# Vertical Solid Shaft P-Base

## Three Phase, Totally Enclosed

### Applications:

For use on: Vertical end suction, short couple, centrifugal, non-clog, mix flow, turbine, and propeller pumps. Totally Enclosed, Fan Cooled construction restricts the free exchange of ambient air inside the motor. Suitable for demanding applications in the process industries. HP type shafts, per NEMA MG-1, 18.625. HPH type shafts, severe duty features, explosion proof, and other modifications such as adding screens are also available through special order. Contact Marathon Motors for more information.



### Features:

- Normal thrust
- Class F insulation
- 1.15 Service Factor
- Suitable for 230 volt part winding start through 100 HP (dual voltage motors)
- Heavy duty lifting lugs
- Drip cover/canopy cap included
- UL Recognized and CSA Certified

NEMA Premium Efficient, Normal Thrust															
HP	RPM	VOLTS	FRAME	CAT. NO.	MODEL NO.	STOCK	LIST PRICE	MULT. SYMB.	NOM. EFF.	F.L. AMPS	WEIGHT	DOWN THRUST	BASE DIA	"C" DIM.	FOOT NOTES
3	3600	230/460	182HP	<b>M875A</b>	182TTFW14005		\$1,291	S5	85.5	7.4/3.7	89	260	9.88	18.05	
	1800	230/460	182HP	<b>M876A</b>	182TTFW14026		\$1,132	S5	87.5	8.4/4.2	124	390	9.88	18.05	
	1200	230/460	213HP	<b>M877A</b>	213TTFW14080		\$1,766	S5	87.5	9.2/4.6	134	560	9.88	22.66	
5	1800	230/460	184HP	<b>M879A</b>	184TTFW14026		\$1,586	S5	87.5	13.0/6.5	79	490	9.88	20.05	
	1200	230/460	215HP	<b>M880A</b>	215TTFW14083		\$2,488	S5	87.5	14.0/7.0	139	650	9.88	23.91	
7 1/2	3600	230/460	213HP	<b>M881A</b>	213TTFW14010		\$2,245	S5	88.5	18.4/9.2	157	380	9.88	22.66	
	1200	230/460	254HP	<b>M883A</b>	254TTFNA14084		\$2,968	S5	89.5	19.6/9.8	401	720	9.88	28.26	
10	3600	230/460	215HP	<b>M884A</b>	215TTFW14021		\$2,445	S5	89.5	24.0/12.0	160	450	9.88	22.66	
	1800	230/460	215HP	<b>M885A</b>	215TTFW14040		\$2,445	S5	89.5	26.0/13.0	158	560	9.88	23.91	
	1200	230/460	256HP	<b>M886A</b>	256TTFNA14084		\$3,351	S5	89.5	26.0/13.0	420	720	9.88	28.26	
15	3600	230/460	254HP	<b>M888</b>	254TTFNA7012		\$2,818	S5	90.2	35.0/17.5	272	520	9.88	28.26	
	1200	230/460	284HP	<b>M890A</b>	284TTFPA14049		\$3,907	S5	90.2	36.0/18.0	400	800	9.88	28.88	
20	3600	230/460	256HP	<b>M892A</b>	256TTFNA14016		\$3,083	S5	90.2	47.0/23.5	413	520	9.88	28.26	
	1800	230/460	256HP	<b>M893</b>	256TTFNA7028		\$3,329	S5	91.0	50.0/25.0	587	640	9.88	28.26	
	1200	230/460	286HP	<b>M894A</b>	286TTFNA14085		\$4,748	S5	90.2	54.0/27.0	438	800	9.88	30.84	
25	3600	230/460	284HP	<b>M896</b>	284TTFNA7508		\$3,257	S5	91.0	57.0/28.5	520	550	9.88	30.84	
	1800	230/460	284HP	<b>M897A</b>	284TTFPA14048		\$3,710	S5	92.4	62.0/31.0	466	700	9.88	28.88	
	1200	230/460	324HP	<b>M898A</b>	324TTFPA14089		\$5,556	S5	91.7	67.0/33.5	610	1000	16.38	33.09	
	900	230/460	326HP	<b>M899A</b>	326TTF14103		\$6,627	S5	89.5	73.0/36.5	835	1100	16.38	35.62	
30	3600	230/460	286HP	<b>M900A</b>	286TTFPA14011		\$3,594	S5	91.0	72.0/36.0	550	550	9.88	27.38	
	1800	230/460	286HP	<b>M901A</b>	286TTFPA14063		\$4,174	S5	92.4	74.0/37.0	653	700	9.88	27.38	
	1200	230/460	326HP	<b>M902A</b>	326TTF14087		\$6,344	S5	91.7	76.0/38.0	788	1000	16.38	35.62	
40	3600	230/460	324HP	<b>M904A</b>	324TTF14003		\$4,744	S5	91.7	92.0/46.0	738	600	16.38	35.62	
	1800	230/460	324HP	<b>M905A</b>	324TTFPA14065		\$4,973	S5	93.0	100/50.0	761	800	16.38	33.09	
	1200	230/460	364HP	<b>M906A</b>	364TTF14087		\$8,305	S5	93.0	102/51.0	934	1000	16.38	37.44	
	900	230/460	365HP	<b>M907</b>	365TTF17102		\$9,604	S5	91.0	111/55.5	1112	1100	16.38	37.44	
50	1800	230/460	326HP	<b>M909A</b>	326TTFPA14049		\$5,897	S5	93.0	122/61.0	649	800	16.38	34.59	
	1200	230/460	365HP	<b>M910A</b>	365TTF14084		\$9,792	S5	93.0	130/65.0	998	1000	16.38	37.44	

PUMP MOTORS (FLUID HANDLING)

Catalog numbers (Cat No.) highlighted in bold blue have efficiency levels that meet EISA requirements

Blue shaded areas are Cast Iron Frames

Continued on next page.

# Vertical Solid Shaft P-Base

## Three Phase, Totally Enclosed

NEMA Premium Efficient, Normal Thrust															
HP	RPM	VOLTS	FRAME	CAT. NO.	MODEL NO.	STOCK	LIST PRICE	MULT. SYMB.	NOM. EFF.	F.L. AMPS	WEIGHT	DOWN THRUST	BASE DIA	"C" DIM.	FOOT NOTES
60	3600	230/460	364HP	<b>M912A</b>	364TTFS14003		\$6,993	S5	93.0	141/70.5	978	600	16.38	37.44	
	1800	230/460	364HP	<b>M913A</b>	364TTFS14058		\$7,297	S5	93.6	142/71.0	998	800	16.38	37.44	
	1200	230/460	404HP	<b>M914A</b>	404TTFS14088		\$11,929	S5	93.6	149/74.5	1232	1400	16.38	40.69	
75	3600	230/460	365HP	<b>M916A</b>	365TTFS7923		\$8,734	S5	93.0	174/87.0	1059	600	16.38	37.44	
	1800	230/460	365HP	<b>M917A</b>	365TTFS14060		\$8,890	S5	94.1	178/89.0	1130	800	16.38	37.44	
	1200	230/460	405HP	<b>M918A</b>	405TTFS14087		\$14,029	S5	93.6	185/92.5	1340	1400	16.38	40.69	
100	900	460	444HP	<b>M919</b>	444TTFS7403		\$16,887	S5	93.0	97.0	1889	1600	16.38	45.81	
	3600	230/460	405HP	<b>M920</b>	405TTFS7612		\$12,579	S5	93.6	220/110	1341	600	16.38	40.69	
	1800	230/460	405HP	<b>M921A</b>	405TTFS14063		\$11,977	S5	94.5	228/114	1430	900	16.38	40.69	
	1200	460	444HP	<b>M922A</b>	444TTFN14080		\$18,701	S5	94.1	124	1865	1400	16.38	43.50	
125	3600	460	444HP	<b>M924</b>	444TTFS7321		\$16,974	S5	94.5	137	1846	600	16.38	45.81	
	1800	460	444HP	<b>M925A</b>	444TTFN14044		\$15,546	S5	94.5	145	1756	1000	16.38	43.50	
	1200	460	445HP	<b>M926A</b>	445TTFN14086		\$22,607	S5	94.1	152	2248	1400	16.38	43.50	
150	3600	460	445HP	<b>M928A</b>	445TTFN14003		\$20,627	S5	94.5	167	1780	600	16.38	43.50	
	1800	460	445HP	<b>M929A</b>	445TTFN14326		\$18,988	S5	95.0	172	2292	1000	16.38	43.50	
	900	460	449HP	<b>M931</b>	449TTFS7109		\$39,890	S5	93.6	206	3290	1600	16.38	54.25	
200	1800	460	445HP	<b>M933A</b>	445TTFN14330		\$26,535	S5	95.0	225	2290	1000	16.38	43.50	

Catalog numbers (Cat No.) highlighted in bold blue have efficiency levels that meet EISA requirements

Blue shaded areas are Cast Iron Frames

## Aeration Fan, Farm / Agricultural Duty, Single Phase TEAO, Rigid Base

### Applications:

Direct drive vane axial fans. These totally enclosed/air over motors must be mounted within the airstream for proper cooling. These aeration fan motors are often used in agricultural applications.

### Features:

- Capacitor start design for high starting torque
- 1.0 Service Factor except as noted
- UL Recognized and CSA Certified
- 18" Leads for ease of connection
- 56Z & 143-5TZ have keyway and 1/4" x 20" UNC tapped hole



HP	RPM	VOLTS	FRAME	OVER LOAD	CAT. NO.	MODEL NO.	STOCK	LIST PRICE	MULT. SYMB.	F.L. AMPS	WEIGHT	"C" DIM.	FOOT NOTES
3/4	3600	115/230	56Z	AUTO	C1467	5KC37NN3544T	✓	\$260	F1	9.8/4.9	20	11.26	10
1	3600	115/230	56Z	AUTO	C1468	5KC49NN2081T	✓	\$288	F1	13.0/6.5	26	11.74	10
1 1/2	3600	115/230	143TZ	AUTO	C1273	5KC49SN8060T	✓	\$581	S1	16.4/8.2	35	12.28	
2	3600	115/230	145TZ	AUTO	C1274	5KCR49TN8058T	✓	\$711	S1	17.8/8.9	37	12.28	1,18
3	3600	230	145T	AUTO	C1275	5KCR49ZN8061T	✓	\$969	S1	13.2	49	13.69	1,18

## Attic Fan, Split Phase Dripproof, Air Over, Resilient Base

### Features:

- Variable torque on two speed motors
- 48Y Frame has 48/56 Frame mounting holes
- 56YZ frame with 3" shaft height, 1/2" diameter shaft, and 5/8" adapter with keyway included
- UL Recognized and CSA Certified



HP	RPM	VOLTS	FRAME	OVER LOAD	CAT. NO.	MODEL NO.	STOCK	LIST PRICE	MULT. SYMB.	F.L. AMPS	WEIGHT	"C" DIM.	FOOT NOTES
1/3	1800/1200	115	48Y	AUTO	B402	48S17D7209	✓	\$209	F1	5.3/2.9	21	10.31	
	1800	115	48Y	AUTO	B400	48S17D997	✓	\$138	F1	6.6	14	9.34	
1/2	1800	115	56YZ	AUTO	B401	56S17D2062	✓	\$172	F1	7.8	18	10.47	53

# Centrifugal Fan, Single Phase

## Dripproof, Rigid Base

### Applications:

Direct drive centrifugal fans installed in relatively clean and dry applications.

### Features:

- Capacitor start/capacitor run design for high starting torque and low amps
- Ball bearings, mechanically locked on shaft end
- 84" leads
- Heavy gauge steel frame and base
- Shafts are 1" longer than NEMA standard for extra clearance
- Rodent screens
- Thermostats for thermal overload protection
- 1.15 Service Factor (unless otherwise noted)
- UL Recognized and CSA Certified



HP	RPM	VOLTS	FRAME	CAT. NO.	MODEL NO.	STOCK	LIST PRICE	MULT. SYMB.	F.L. AMPS	WEIGHT	"C" DIM.	FOOT NOTES
5	1800	208-230	184TZ	Z124A	184TBDW7369		\$1,388	S1	23.0-21.0	82	16.72	13
7 1/2	1800	208-230	215TZ	Z125	215TBDW7361		\$1,837	S1	35.2	135	19.19	
10	1800	230	215TZ	Z126	215TBDW7362		\$1,939	S1	44.0	158	18.70	
15	1800	230	256TZ	Z127	256TBDX7028		\$2,404	S1	61.0	187	24.06	17

## Condenser Fan/Heat Pump, PSC, Open Air Over Thru-Bolt, Shaft Up or Horizontal

### Applications:

Direct drive condenser fans mounted vertically, shaft up. Models with open brackets should be mounted where they are shielded from rain. These motors need to be mounted within the airflow of the fan for proper cooling.

### Features:

- Frame and shaft end bracket enclosed, except X011, X012, and X208 have open frames and X426 has open frame and brackets
- Single and multi-speed models as noted
- Ball bearings
- Weather resistant reversing plug
- 30" long leads
- Shaft with flat, unless otherwise noted
- 60°C ambient (as noted)
- Shaft slinger
- 1-5/8" Extended thru-bolts on shaft end, except where noted
- Automatic reset thermal protector
- Lug mount kits and other accessories available, see Accessories section
- UL Recognized and CSA Certified
- Capacitor not included, see Accessories section



X208



X081



X426



X011

HP	RPM	VOLTS	FRAME	CAT. NO.	MODEL NO.	STOCK	LIST PRICE	MULT. SYMB.	F.L. AMPS	WEIGHT	FRAME LENGTH	SHAFT DIM.	FOOT NOTES
1/4	1625/1	208-230	48Y	X012	48A17O2006	✓	\$147	F1	1.8-1.8	12	4 1/2	1/2 x 6	30,34,44
	1625/1	460	48Y	X420	48A17O169	✓	\$197	F1	1.0	12	4	1/2 x 6	34
	1075/2	208-230	48Y	X081	48A11O2031	✓	\$164	F1	1.9-1.9	12	4 1/4	1/2 x 6	
	1075/1	208-230	48Y	X213	48A11O1524	✓	\$140	F1	1.4-1.2	12	4 1/4	1/2 x 6	21
	1075/1	208-230	48Y	X087	48A11O2029	✓	\$133	F1	2.0-2.0	12	4 1/4	1/2 x 6	
	1075/1	460	48Y	X423	48A11O2055	✓	\$152	F1	1.0	13	4 1/4	1/2 x 6	36
1/3	825/1	208-230	48Y	X097	48A8O182	✓	\$197	F1	1.8-1.8	13	4 1/2	1/2 x 6	
	1625/3	208-230	48Y	X011	48A17O2005	✓	\$158	F1	2.3-2.3	14	4 3/4	1/2 x 6	30,34,44
	1075/2	208-230	48Y	X083	48A11O2034	✓	\$174	F1	3.0-3.0	18	4 3/4	1/2 x 6	

Continued on next page.

## Condenser Fan/Heat Pump, PSC, Open Air Over

Thru-Bolt, Shaft Up or Horizontal

HP	RPM	VOLTS	FRAME	CAT. NO.	MODEL NO.	STOCK	LIST PRICE	MULT. SYMB.	F.L. AMPS	WEIGHT	FRAME LENGTH	SHAFT DIM.	FOOT NOTES	
1/3	1075/1	208-230	48Y	X214	48A11O1525	✓	\$139	F1	2.3-2.6	139	4 1/2	1/2 x 6	45	
	1075/1	208-230	48Y	X088	48A11O2032	✓	\$143	F1	3.0-3.0	143	4 3/4	1/2 x 6		
	1075/1	460	48Y	X424	48A11O2054	✓	\$172	F1	1.4	172	4 3/4	1/2 x 6	36	
	825/1	208-230	48Y	X086	48A8O2001	✓	\$221	F1	2.4-2.4	221	5 1/4	1/2 x 6		
1/2	1625/1	460	48Y	X422	48A17O172	✓	\$249	F1	1.7	249	5	1/2 x 6	36	
	1625/1	575	48Y	X454	48A17O250	✓	\$249	F1	1.35	249	5	1/2 x 6	36	
	1075/1	208-230	48Y	X096	48A11O840	✓	\$191	F1	4.2-4.2	191	5 1/2	1/2 x 6		
	1075/1	208-230	48Y	X221	48A11O1526	✓	\$169	F1	2.7-2.6	169	5	1/2 x 6	45	
	1075/1	460	48Y	X400	48A11O2017	✓	\$194	F1	1.8	194	5	1/2 x 6	35	
	1075/1	575	48Y	X453	48A11O1771	✓	\$194	F1	1.15	194	5	1/2 x 6	35	
	825/1	208-230	48Y	X098	48A8O181	✓	\$266	F1	3.3-3.3	266	5 1/2	1/2 x 6		
	825/1	208-230	56Z	X208	56A8O5	✓	\$407	F1	3.4-3.4	407	8 5/8	5/8 x 6 w/key/flat	30	
	3/4	1075/2	208-230	48Y	X085	48A11O678	✓	\$221	F1	5.1-5.1	221	5 1/2	1/2 x 6	
		1075/1	208-230	48Y	X298	48A11O2059	✓	\$185	F1	4.0-4.2	185	5 1/4	1/2 x 6	
1075/1		208-230	48Y	X090	48A11O2007	✓	\$209	F1	4.6-4.6	209	5 1/2	1/2 x 6		
1075/1		460	48Y	X099	48A11O2016	✓	\$223	F1	2.5	223	5 1/2	1/2 x 6	34	
1075/1		460	48YZ	X426	48A11O1375	✓	\$270	F1	2.2	270	5 1/2	5/8 x 4.5 w/key	69	
1075/1		575	48Y	X455	48A11O1770	✓	\$223	F1	1.7	223	5 1/2	1/2 x 6	35	
1	1075/1	200-230/460	56Z	P190	5KCP49ZN9617T	✓	\$477	F1	6.7-6.8/3.4	477	9.0	5/8 x 4		

## Condenser Fan/Heat Pump, PSC, Open Air Over

Thru-Bolt Mount, Shaft Down

### Applications:

Direct drive condenser fans mounted vertically, shaft down. These motors need to be mounted within the airflow of the fan for proper cooling.

### Features:

- Frame and opposite shaft end bracket are enclosed for vertical shaft down mounting
- Weather resistant reversing plug
- 30" Long leads
- Shaft slinger
- 1-1/4" Extended thru-bolts on shaft end, except where noted
- Automatic reset thermal protector
- Ball Bearings
- UL Recognized and CSA Certified
- Capacitor not included, see Accessories section



HP	RPM	VOLTS	FRAME	CAT. NO.	MODEL NO.	STOCK	LIST PRICE	MULT. SYMB.	F.L. AMPS	WEIGHT	FRAME LENGTH	SHAFT DIM.	FOOT NOTES
1/8	825	208-230	48Y	X278	48A8O206	✓	\$181	F1	0.9-0.9	11	4 1/4	1/2 X 4 3/4	37,44
1/6	1075	208-230	48Y	X440	48A11O2065	✓	\$119	F1	1.0-0.9	10	4	1/2 X 6	
1/5	1075	208-230	48Y	X216	48A11O1097	✓	\$133	F1	1.8-1.6	10	3 3/4	1/2 X 6	37,44,60
1/4	1075	208-230	48Y	X441	48A11O2062	✓	\$146	F1	1.35-1.35	12	4 1/4	1/2 X 6	
1/3	1075	208-230	48Y	X442	48A11O2064	✓	\$156	F1	2.0-1.95	14	4 3/4	1/2 X 6	
	1075	208-230	48Y	X297	48A11T509	✓	\$141	F1	1.8-1.8	12	4 1/4	1/2 X 3 3/4	N,29,41,60
1/2	1075	208-230	48Y	X443	48A11O2063	✓	\$173	F1	3.9-3.9	18	5 1/4	1/2 X 6	
3/4	1075	208-230	48Y	X444	48A11O1596	✓	\$230	F1	4.3-4.7	18	5 1/2	1/2 X 6	

## Condenser Fan/Heat Pump, PSC, Air Over

### 48 Frame, Thru-Bolt, All-Angle

#### Applications:

Direct drive condenser fans for all angle mounting. These motors need to be mounted within the airflow of the fan for proper cooling.

#### Features:

- Frame and end brackets enclosed
- Single and multi-speed models, as noted
- Ball bearings (except as noted)
- Weather resistant reversing plug
- 30" long leads
- Shaft slinger
- 1-1/2" Thru-bolts on shaft end, 1" thru-bolts on lead end (except as noted)
- Automatic reset thermal protector
- Weep holes with removable plugs on end brackets. Remove bottom plug after installation.
- Lug mount kits and other accessories available (see Accessories section)
- 60°C ambient, as noted
- UL Recognized and CSA Certified
- Capacitor not included, see Accessories section



HP	RPM	VOLTS	FRAME	CAT. NO.	MODEL NO.	STOCK	LIST PRICE	MULT. SYMB.	F.L. AMPS	WEIGHT	FRAME LENGTH	SHAFT DIM.	FOOT NOTES
1/6	1075/2	208-230	48Y	X429	48A11T2020	✓	\$160	F1	1.3-1.3	11	4	1/2 x 6	36
	1075/1	208-230	48Y	X411	48A11T2008	✓	\$152	F1	1.3-1.3	10	3 3/4	1/2 x 6	
	825/1	208-230	48Y	X465	48A8T11002	✓	\$160	F1	1.1-1.1	12	4 1/4	1/2 x 6	45
1/4	1625/1	208-230	48Y	X467	48A17T87	✓	\$143	F1	2.0-2.0	12	4 1/2	1/2 x 6	21,36
	1625/2	208-230	48Y	X463	48A17T356	✓	\$164	F1	1.4-1.4	13	4 1/2	1/2 x 6	45,94
	1075/2	208-230	48Y	X430	48A11T463	✓	\$174	F1	1.8-1.8	16	4 1/2	1/2 x 6	36
	1075/1	208-230	48Y	X412	48A11T569	✓	\$169	F1	1.4-1.4	16	4 1/4	1/2 x 6	45
	1075/1	460	48Y	X456	48A11T578	✓	\$174	F1	0.75	15	4 1/2	1/2 x 6	45
	840/1	208-230	48Y	X450	48A8T71	✓	\$164	F1	1.9-1.9	17	5 1/4	1/2 x 6	45
	1625/1	208-230	48Y	X466	48A17T86	✓	\$157	F1	2.0-2.0	15	5	1/2 x 6	21,36
1/3	1075/2	208-230	48Y	X415	48A11T2012	✓	\$186	F1	2.6-2.6	16	5	1/2 x 6	36
	1075/1	208-230	48Y	X413	48A11T529	✓	\$183	F1	1.9-1.9	14	4 3/4	1/2 x 6	45
	1075/1	460	48Y	X457	48A11T579	✓	\$185	F1	0.9	17	5	1/2 x 6	36,45
	825/1	208-230	48Y	X451	48A8T72	✓	\$173	F1	2.3-2.3	19	5 3/4	1/2 x 6	34,45
	1625/1	208-230	48Y	X468	48A17T96	✓	\$177	F1	2.9-2.6	16	5 1/4	1/2 x 6	21
1/2	1625/2	208-230	48Y	X464	48A17T359	✓	\$199	F1	3.1-2.9	17	5 1/4	1/2 x 6	45
	1075/2	208-230	48Y	X416	48A11T2013	✓	\$204	F1	4.2-4.2	19	5 1/2	1/2 x 6	36
	1075/1	208-230	48Y	X414	48A11T571	✓	\$201	F1	2.7-2.7	17	5	1/2 x 6	36,45
	1075/1	460	48Y	X458	48A11T580	✓	\$204	F1	1.4	20	5 1/2	1/2 x 6	36,45
	825/1	208-230	48Y	X452	48A8T73	✓	\$213	F1	3.1	21	6 1/4	1/2 x 6	45
3/4	1075/1	208-230	48Y	X469	48A11T276	✓	\$177	F1	4.2-3.65	21	6	1/2 x 6	21,63
	1075/1	460	48Y	X459	48A11T581	✓	\$230	F1	2.1	23	6	1/2 x 6	32,45
1	1075/1	460	48Y	X462	48A11T619	✓	\$272	F1	3.4	27	7 1/4	1/2 x 6	32,45

## Condenser Fan/Heat Pump, PSC, Open Air Over

### Rigid Base, Shaft Up or Horizontal

#### Applications:

Condenser fans, installed outdoors. These motors need to be mounted within the airflow of the fan for proper cooling.

#### Features:

- Frame and shaft end bracket enclosed
- Heavy gauge steel constructions
- 56Y frame has non-NEMA BA dimension of 1.97"
- Automatic reset thermal protector
- Flat and keyway on shaft
- Ball Bearings
- UL Recognized and CSA Certified
- Capacitor included on X432, see Accessories section to order capacitor for X433



HP	RPM	VOLTS	FRAME	CAT. NO.	MODEL NO.	STOCK	LIST PRICE	MULT. SYMB.	F.L. AMPS	WEIGHT	FRAME LENGTH	SHAFT DIM.	FOOT NOTES
3/4	1075	208-230/460	56YZ	X432	56A11O29	✓	\$334	F1	4.6-4.4/2.2	22	11.88	5/8 x 4 1/2	36
1	1075	208-230/460	56YZ	X433	56A11O30	✓	\$398	F1	5.8-5.4/2.7	27	12.38	5/8 x 4 1/2	



# Condenser Fan/Heat Pump, Single Phase, PSC

## 56 Frame, Resilient Ring, Thru-Bolt

### Applications:

Direct drive condenser fans mounted vertically, shaft up or horizontal. These motors need to be mounted within the airflow of the fan for proper cooling.

### Features:

- Enclosed shaft end bracket with vented frame
- Ball bearings
- 30" long leads (except P243)
- Shaft slinger
- 60°C ambient, as noted
- Automatic reset thermal protector
- Flat & keyway on shaft
- UL Recognized and CSA Certified
- Capacitor not included, see Accessories section



### Open Air Over, Shaft Up

HP	RPM	VOLTS	FRAME	CAT. NO.	MODEL NO.	STOCK	LIST PRICE	MULT. SYMB.	F.L. AMPS	WEIGHT	FRAME LENGTH	SHAFT DIM.	FOOT NOTES
3/4	1075	208-230/460	56Y	X207	56A11O5311	✓	\$377	F1	3.9-3.6/1.8	31	8 1/4	5/8 x 6	37,45
1	1075	208-230/460	56Y	X206	56A11O5310	✓	\$398	F1	5.4-5.2/2.6	34	10 1/16	5/8 x 6	37
1 1/2	1075	208-230/460	56Y	X271	56A11O5305	✓	\$454	F1	7.7-7.6/3.8	43	9 3/4	5/8 x 6	34,45

### Dripproof

HP	RPM	VOLTS	FRAME	CAT. NO.	MODEL NO.	STOCK	LIST PRICE	MULT. SYMB.	F.L. AMPS	WEIGHT	FRAME LENGTH	SHAFT DIM.	FOOT NOTES
1/2	825/1	115/208-230	56Y	P245	5KCP49PN9812S	✓	\$513	F1	6.2/3.8-3.1	31	13.66	5/8 X 6	
3/4	1075/1	208-230/460	56Y	P243	5KCP49RN9611S	✓	\$486	F1	4.9-3.8/1.9	33	13.66	5/8 X 6	
	825/1	208-230	56Y	P246	5KCP49UN9811S	✓	\$556	F1	5.8-5.6	32	14.47	5/8 X 6	
1	1075/3	115	56Y	P184	5KCP49UN9612S	✓	\$532	F1	10.8	40	14.87	5/8 X 6	
	1075/3	200-230	56Y	P185	5KCP49UN9614S	✓	\$532	F1	4.8-5.0	34	14.87	5/8 X 6	
	1075/1	208-230/460	56Y	P244	5KCP49UN9613S	✓	\$511	F1	6.3-5.0/2.5	40	14.47	5/8 X 6	
	825/1	208-230/460	56Y	P180	5KCP49WN9813S	✓	\$586	F1	6.3-6.4/3.2	39	11.24	5/8 x 6	

# Commercial Condenser Fan/Heat Pump, PSC

## Open Air Over, Belly Band, Shaft Up

### Applications:

Heavy duty design for commercial direct drive condenser fans mounted vertically, shaft up. These motors need to be mounted within the airflow of the fan for proper cooling.

### Features:

- Open frame and end brackets
- Shaft with flat, unless otherwise noted
- Unique Rain Shield fits over shaft to protect motor in vertical shaft up position
- Shaft slinger
- Automatic reset thermal protector
- 60°C ambient (as noted)
- Ball bearings
- UL Recognized and CSA Certified
- Capacitor not included, see Accessories section



HP	RPM	VOLTS	FRAME	CAT. NO.	MODEL NO.	STOCK	LIST PRICE	MULT. SYMB.	F.L. AMPS	WEIGHT	FRAME LENGTH	SHAFT DIM.	FOOT NOTES
0.4	1075	200-230/460	48Y	X445	48A11O1732		\$204	F1	3.0-2.8/1.4	29	5 1/2	1/2 x 4	
0.6	1075	200-230/460	48Y	X446	48A11O1643	✓	\$225	F1	3.0-3.6/1.8	20	6 7/8	1/2 x 4	
0.8	1075	200-230/460	48Y	P193	5KCP39SNB480S		\$252	F1	4.0/2.0	21	14 1/5	1/2 x2 3/4	
	1075	200-230/460	48Y	P194	5KCP39SNB481S		\$301	F1	4.0/2.0	21	9 1/3	5/8 x 4 7/8	
	1075	200-230/460	48Y	X447	48A11O1642	✓	\$301	F1	5.0-4.4/2.2	27	8 3/4	1/2 x 4	45
1	1075	200-230/460	48Y	P195	5KCP39SNB482S	✓	\$325	F1	5.6/2.8	21	10 5/8	5/8 x 5 1/4 w/key/flat	
	1075	200-230/460	56Y	X448	56A11O5314	✓	\$325	F1	6.0-5.2/2.6	33	8 3/4	5/8 x 4 w/key/flat	45
	1075	575	56Y	P196	5KCP39TNB763T	✓	\$325	F1	2.6	22	10 1/4	1/2 x 5 1/4	
1.5	1075	200-230/460	56Y	P197	5KCP39UNB767T	✓	\$373	F1	8.1-7.8/3.9	23	10 1/4	5/8 spcl.	d
	1075	200-230/460	56Y	X449	56A11O5315		\$373	F1	7.0-7.0/3.5	39	9 1/4	5/8 x 4	45
	1075	575	56Y	P198	5KCP39UNB764T	✓	\$373	F1	3.5	23	10 1/4	1/2 x 5 1/4	

# Commercial Condenser Fan/Heat Pump, PSC

## Resilient Base, Shaft Up or Horizontal

### Applications:

Condenser fans, installed outdoors. These motors need to be mounted within the airflow of the fan for proper cooling.

### Features:

- Frame and shaft end bracket enclosed
- Automatic reset thermal protector
- Ball bearings
- UL Recognized and CSA Certified
- Capacitor included



HP	RPM	VOLTS	FRAME	CAT. NO.	MODEL NO.	STOCK	LIST PRICE	MULT. SYMB.	F.L. AMPS	WEIGHT	FRAME LENGTH	SHAFT DIM.	FOOT NOTES
1/2	1075	208-230/460	48YZ	X431	48A11O1461	√	\$263	F1	3.0-3.0/1.5	19	11.94	1/2 x 4 1/2	

# Commercial Condenser Fan/Heat Pump, Three Phase

## Open Air Over, Rigid Base, Shaft Up or Horizontal

### Applications:

Commercial condenser fans may be installed outdoors. These motors need to be mounted within the airflow of the fan for proper cooling. Used on Trane, Carrier, Climtrol and York units, 5 tons and larger.



As  
Noted

### Features:

- 70°C ambient (except as noted)
- Enclosed shaft end bracket, vented frame
- Continuous duty, air over
- Automatic reset thermal protector
- Shaft slinger
- Threaded lead exit
- Nameplated 60/50 hertz 190/380 volts, at next lower HP
- Double sealed ball bearings
- Flat and keyway on shaft
- Patented VCD™ - Voltage Change Device (as noted)
- Ball Bearings
- UL Recognized and CSA Certified



HP	RPM	VOLTS	FRAME	CAT. NO.	MODEL NO.	STOCK	LIST PRICE	MULT. SYMB.	F.L. AMPS	WEIGHT	FRAME LENGTH	SHAFT DIM.	FOOT NOTES
1/3	1140	208-230/460	56Z	X532	56T11O11001	√	\$355	F1	1.8-1.8/0.9	22	13.37	1/2 x 5	45,50
1/2	1140	208-230/460	56Z	X533	56T11O11002	√	\$382	F1	2.1-2.0/1.0	20	13.37	5/8 x 5	45,50
	850	208-230/460	56HZ	X529	56T8O5531	√	\$547	F1	2.9-3.0/1.5	31	14.68	5/8 x 5	VC,5
3/4	1140	208-230/460	56HZ	X512	56T11O15511		\$425	F1	2.7-3.0/1.5	27	14.18	5/8 x 5	VC,5
1	1140	208-230/460	56HZ	K1485	5K49RN6118S		\$435	F1	4.2-4.0/2.0	33	16.02	5/8 X 6	46
	1140	208-230/460	56HZ	X513	56T11O5305	√	\$461	F1	4.1-4.2/2.1	29	14.68	5/8 x 5	VC,5
	850	208-230/460	56HZ	X528	56T8O5306	√	\$614	F1	5.1-5.3/2.65	49	17.06	5/8 x 5	VC,5
1 1/2	1140	208-230/460	56HZ	K1486	5K48TN6119S		\$473	F1	5.1-5.0/2.5	38	16.77	5/8 X 6	46
	1140	208-230/460	56HZ	X523	56T11O5306	√	\$501	F1	5.45-5.4/2.7	36	15.68	5/8 x 5	VC,5
	850	208-230/460	56HZ	X531	56T8O15504	√	\$668	F1	7.0-7.0/3.5	47	16.68	5/8 x 5	VC,5
2	1140	208-230/460	56HZ	X525	56T11O5310	√	\$543	F1	7.2-6.8/3.4	47	16.68	5/8 x 5	VC,5

# Condenser Fan/Heat Pump, Three Phase

## Open Air Over, Belly Band/Resilient Ring

### Applications:

Commercial condenser fans may be installed outdoors. These motors need to be mounted within the airflow of the fan for proper cooling. Used on Trane, Carrier, Climatrol and York units, 5 tons and larger.

### Features:

- 70°C ambient (except as noted)
- Enclosed shaft end bracket, vented frame
- Automatic reset thermal protector
- Nameplate 60/50 hertz 190/380 volts, at next lower HP (except as noted)
- Double sealed ball bearings
- 5/8" Dia. x 5" long shaft with flat and keyway
- Ball bearings
- Threaded lead exit
- Patented VCD™ - Voltage Change Device
- 4 Locating screws 90 degrees apart, 3.33" from outer edge of shaft slinger
- Hubs on both ends will accept resilient base kits, see Accessories section (except X524 and X526 - horizontal only)
- UL Recognized and CSA Certified
- External shaft slinger on all, internal slinger on 5K models



As Noted



HP	RPM	VOLTS	FRAME	CAT. NO.	MODEL NO.	STOCK	LIST PRICE	MULT. SYMB.	F.L. AMPS	WEIGHT	FRAME LENGTH	FOOT NOTES
1/3	850	208-230/460	56Y	X511	56T8O5303	✓	\$493	F1	2.3-2.5/1.25	23	9 1/2	VC
1/2	1140	200-230/460	56Y	X500	56T11O5300	✓	\$392	F1	2.4-2.7/1.35	21	9.00	VC
	1140	575	56Y	K1500	5K49MN6432S	✓	\$467	F1	1.0	27	9.49	33,46
3/4	1140	208-230/460	56Y	K378	5K46LN6033S		\$410	F1	3.0-3.4/1.7	25	8.89	46
	1140	200-230/460	56Y	X501	56T11O5301	✓	\$434	F1	3.1-3.2/1.6	24	9.50	VC
	1140	575	56Y	K1505	5K46LN6428S	✓	\$490	F1	1.5	25	8.89	33,46
1	850	208-230/460	56Y	X506	56T8O5301		\$574	F1	3.6-3.6/1.8	39	11.00	VC
	1140	208-230/460	56Y	K379	5K49RN6034S		\$429	F1	4.2-4.0/2.0	33	10.02	46
	1140	200-230/460	56Y	X502	56T11O5302	✓	\$455	F1	4.0-4.2/2.1	28	10.00	VC
1	1140	575	56Y	X522	56T11O5308	✓	\$427	F1	1.7	28	10.00	70
	1140	575	56Y	K1510	5K49RN6429S		\$427	F1	1.6	33	16.02	33,46
	850	208-230/460	56Y	K1482	5K48WN3013S		\$563	F1	5.1-5.2/2.6	44	10.77	46
1	850	200-230/460	56Y	X507	56T8O5302	✓	\$597	F1	5.3-5.3/2.6	46	12.00	VC
	850	575	56Y	K1511	5K48WN3181S	✓	\$563	F1	2.0	44	10.77	d,33,46
	850	575	56Y	X527	56T8O5304	✓	\$597	F1	2.1	46	12.00	70
1 1/2	1140	200-230/460	56Y	X503	56T11O5303	✓	\$497	F1	5.5-5.4/2.7	35	11.00	VC
	1140	575	56Y	X524	56T11O5307	✓	\$497	F1	2.2	35	11.00	73
	1140	575	56Y	K1515	5K48TN6430S		\$467	F1	2.2	38	10.77	33,46
2	850	208-230/460	56Y	X530	56T8O5307	✓	\$643	F1	7.5-6.8/3.4	47	11.25	VC
	1140	208-230/460	56Y	X509	56T11O5304	✓	\$539	F1	7.2-6.8/3.4	49	12.00	VC
	1140	575	56Y	K1520	5K49ZN6433S	✓	\$497	F1	2.5	49	11.97	d,33,46
2	1140	575	56Y	X526	56T11O5309	✓	\$539	F1	2.7	45	11.63	73

### Shaft Up with Fan Canopy / Rainshield

HP	RPM	VOLTS	FRAME	CAT. NO.	MODEL NO.	STOCK	LIST PRICE	MULT. SYMB.	F.L. AMPS	WEIGHT	FRAME LENGTH	FOOT NOTES
1/2	1140	200-230/460	48Y	K1403	5K36PN345S	✓	\$465	F1	2.2-2.6/1.3	20	7.95	46
3/4	1140	200-230/460	48Y	K1404	5K38SN267S	✓	\$489	F1	3.3-3.8/1.9	24	8.95	46
	1140	575	48Y	K1405	5K39SNB765T	✓	\$519	F1	1.5	21	8.50	46
1	1140	200-230/460	48Y	K1402	5K39SNB505S	✓	\$539	F1	4.4-4.0/2.0	21	8.50	46
1 1/2	1140	200-230/460	48Y	K1407	5K39SNB587S	✓	\$590	F1	6.0-5.8/2.9	21	10.63	46

# Fan and Blower - Direct Drive, PSC Open Air Over, Resilient Ring, Thru-Bolt Mount

## Features:

- Open frames and brackets (except X011 and X012 have enclosed shaft end bracket)
- Single and multi-speed models as noted
- Grommated lead exit
- Weather resistant reversing plug
- 2-1/4" resilient ring mounting except where noted (base not included, see Accessories section)
- 2 1/2" adapter rings supplied, shipped loose in box
- Extended thru-bolts on shaft end
- 30" long leads
- Automatic reset thermal protector
- Ball bearings
- UL Recognized and CSA Certified
- Capacitor not included, see Accessories section



X001



X211



X242



X219



X033

HP	RPM	VOLTS	FRAME	CAT. NO.	MODEL NO.	STOCK	LIST PRICE	MULT. SYMB.	F.L. AMPS	WEIGHT	FRAME LENGTH	SHAFT DIM.	FOOT NOTES	
1/5	1075/3	115	48Y	X219	48A11O2047	✓	\$132	F1	3.5	11	4	1/2 x 4	39	
1/4	1625/3	115	48Y	X013	48A17O152	✓	\$145	F1	2.9	12	5	1/2 x 4	32	
	1625/3	208-230	48Y	X014	48A17O154	✓	\$147	F1	1.8-1.35	11	4 1/4	1/2 x 4	32	
1/4	1625/1	208-230	48Y	X012	48A17O2006	✓	\$147	F1	1.8-1.8	12	4 1/2	1/2 x 6	34,44	
	1075/3	115	48Y	X000	48A11O1798	✓	\$139	F1	3.4	12	4 1/4	1/2 x 4	32	
	1075/3	208-230	48Y	X001	48A11O1799	✓	\$143	F1	1.5-1.5	12	4 1/2	1/2 x 4	32	
	1075/3	277	48Y	X018	48A11O1350	✓	\$149	F1	1.6	11	4 1/4	1/2 x 4	32	
	1075/1	208-230	48Y	X006	48A11O2001	✓	\$137	F1	2.0-2.0	11	4 1/4	1/2 x 4	32	
	1075/1	208-230	48Y	X417	48A11O2051	✓	\$146	F1	2.0-2.2	13	4 1/4	1/2 x 6	51,116	
	1/3	1625/3	115	48Y	X015	48A17O151	✓	\$154	F1	4.0	13	4 3/4	1/2 x 4	32
		1625/3	208-230	48Y	X011	48A17O2005	✓	\$158	F1	2.3-2.3	14	4 3/4	1/2 x 6	34,44
		1075/4	115	48Y	X236	48A11O699	✓	\$173	F1	6.4	16	4 3/4	1/2 x 6	39
		1075/4	208-230	48Y	X237	48A11O694	✓	\$176	F1	4.8-4.8	16	5 1/4	1/2 x 6	39
1075/3		115	48Y	X002	48A11O1769	✓	\$149	F1	4.6	14	4 3/4	1/2 x 4	32	
1075/3		208-230	48Y	X003	48A11OB2042	✓	\$152	F1	3.3-3.3	14	4 3/4	1/2 x 4	32	
1075/3		277	48Y	X019	48A11O1351	✓	\$159	F1	2.7	15	4 3/4	1/2 x 4	32	
1075/2		460	48Y	X037	48A11O1876	✓	\$299	F1	1.0	14	4 3/4	1/2 x 6	51	
1075/1		208-230	48Y	X418	48A11O2052	✓	\$155	F1	3.1-3.1	14	4 1/2	1/2 x 6	51,116	
825/1		230	48Y	X209	48A8O183	✓	\$190	F1	2.8	17	5 3/4	1/2 x 5 1/2	34,43	
1/2	1625/3	115	48Y	X016	48A17O153	✓	\$172	F1	5.0	16	5 1/4	1/2 x 4	32	
	1625/3	208-230	48Y	X017	48A17O155	✓	\$174	F1	4.1-4.1	16	5 1/4	1/2 x 4	32	
	1075/4	115	48Y	X033	48A11O1674	✓	\$145	F1	6.1	15	5	1/2 x 5	31,73	
	1075/3	115	48Y	X004	48A11O1755	✓	\$168	F1	6.2	17	5 1/2	1/2 x 4	32	
	1075/3	208-230	48Y	X005	48A11O1756	✓	\$170	F1	2.65-2.6	17	5 1/2	1/2 x 4	32	
	1075/3	277	48Y	X020	48A11O1352	✓	\$177	F1	3.6	17	5 1/2	1/2 x 4	32	
	1075/1	208-230	48Y	X419	48A11O2053	✓	\$173	F1	4.2	17	5 1/4	1/2 x 6	51,116	
	3/4	1625/3	230	48Y	X022	48A17O174	✓	\$191	F1	3.7	18	5 1/2	1/2 x 5 1/2	39,43
		1075/4	208-230	48Y	X241	48A11O697	✓	\$223	F1	5.4-5.4	17	5 1/2	1/2 x 6	39
		1075/3	115	48Y	X009	48A11O787	✓	\$196	F1	10.2	20	5 3/4	1/2 x 4	32
1075/3		208-230	48Y	X010	48A11O2046	✓	\$199	F1	5.6	19	5 1/2	1/2 x 4	32	
1075/3		277	48Y	X021	48A11O1353	✓	\$204	F1	5.0	20	5 3/4	1/2 x 4	32	
1	1625/2	208-230	48Y	X211	48A17O125	✓	\$248	F1	6.2	20	6 1/4	1/2 x 2 1/2	39,42,43	
	1075/3	230	48Y	X023	48A11O1583	✓	\$227	F1	5.3	24	6 1/2	1/2 x 5	34	
	1075/3	208-230	48YZ	X242	48A11O756	✓	\$377	F1	6.2	26	7 1/4	5/8 x 4	39,51	

## Fan and Blower - Direct Drive, PSC Open Air Over, Resilient Ring



### Applications:

Single speed PSC motors designed to replace PSC and Shaded pole motors, used in direct drive furnace, air conditioners, and others blowers.

### Features:

- Open frame and brackets
- Heavy gauge steel frame and base
- Shaft with flat
- 70°C ambient
- 37" Leads
- Thermal overload protection
- 1/4" terminals on the capacitor leads
- 2 1/4" resilient rings, includes 2 1/2" expanders
- Capacitor not included, see Accessories section

HP	RPM	VOLTS	FRAME	CAT. NO.	MODEL NO.	STOCK	LIST PRICE	MULT. SYMB.	F.L. AMPS	WEIGHT	FRAME LENGTH	SHAFT DIM.	FOOT NOTES
1/6	1625	115	48Y	X477	48A17O128	√	\$138	F1	2.6	9	4	1/2 x 4	
	1625	230	48Y	X475	48A17O123	√	\$138	F1	1.3	9	4	1/2 x 4	
	1075	115	48Y	X473	48A11O1046	√	\$133	F1	2.9	9	4	1/2 x 4	
	1075	230	48Y	X471	48A11O1044	√	\$133	F1	1.3	10	4	1/2 x 4	
1/4	1625	230	48Y	X476	48A17O124	√	\$147	F1	1.8	10	4 1/4	1/2 x 4	
	1075	115	48Y	X472	48A11O1045	√	\$139	F1	4.0	11	4 1/4	1/2 x 4	
	1075	230	48Y	X474	48A11O1047	√	\$139	F1	2.0	11	4 1/4	1/2 x 4	

## Fan and Blower - Direct Drive, PSC Open Air Over, Torsion Flex Mount

### Applications:

Residential and commercial furnaces, air conditioners, exhaust fans, and other air handling equipment installed in clean and dry environments.

### Features:

- Open frames and brackets
- Three lug mount fits 9" or 10" bolt circle.  
Mounting holes on lugs are .435" dia., with grommets and sleeves for .26" dia. option.
- Multi-speed capacity
- Weather resistant reversing plug
- 30" long leads
- Automatic reset thermal protector
- Ball Bearings
- UL Recognized and CSA Certified
- Capacitor not included, see Accessories section



HP	RPM	VOLTS	FRAME	CAT. NO.	MODEL NO.	STOCK	LIST PRICE	MULT. SYMB.	F.L. AMPS	WEIGHT	FRAME LENGTH	SHAFT DIM.	FOOT NOTES
1/4	1075/4	115	48Y	X034	48A11O1773	√	\$160	F1	3.3	14	4 1/2	1/2 x 6	
1/3	1075/4	115	48Y	X035	48A11O1774	√	\$172	F1	4.5	15	4 1/2	1/2 x 6	
1/2	1075/4	115	48Y	X036	48A11O1772	√	\$190	F1	6.0	19	5	1/2 x 6	

## Fan & Blower - Direct Drive, PSC Open Air Over, Extended Thru-Bolt, 460 Volt

### Applications:

Residential and commercial furnaces, air conditioners, exhaust fans, and other air handling equipment installed in clean and dry environments.

### Features:

- Enclosed frame and open end brackets
- Multi-speed capability
- Grommeted lead exit
- Weather resistant reversing plug
- Automatic reset thermal protector
- 7/8" extended thru-bolts on shaft end
- Ball Bearings
- UL Recognized and CSA Certified
- Capacitor not included, see Accessories section



HP	RPM	VOLTS	FRAME	CAT. NO.	MODEL NO.	STOCK	LIST PRICE	MULT. SYMB.	F.L. AMPS	WEIGHT	FRAME LENGTH	SHAFT DIM.	FOOT NOTES
1/3	1075/2	460	48Y	X037	48A11O1876	√	\$299	F1	1.0	14	4 3/4	1/2 X 6	51
1/2	1075/2	460	48Y	X038	48A11O1874	√	\$305	F1	1.6	17	5 1/4	1/2 X 6	51
3/4	1075/2	460	48Y	X039	48A11O1875	√	\$311	F1	2.1	19	5 1/2	1/2 X 6	51

# Fan and Blower - Direct Drive, PSC, Open Air Over Belly Band Thru-Bolt, Double Shaft

## Applications:

Continuous air over applications, such as room air conditioners, fan coil units, and other air moving applications.

## Features:

- Open frame and brackets
- Multi-speed capability
- Automatic reset thermal protector
- 30" leads
- CCW rotation, fixed lead end
- 1" extended Thru-bolts both ends
- 20" overall length
- Length adapter kits included where noted
- Ball bearings
- UL Recognized and CSA Certified
- Capacitor not included, see Accessories section



HP	RPM	VOLTS	FRAME	CAT. NO.	MODEL NO.	STOCK	LIST PRICE	MULT. SYMB.	F.L. AMPS	WEIGHT	FRAME LENGTH	SHAFT DIM.	FOOT NOTES
1/8	1075/3	115	48Y	X064	48A11O2011		\$132	F1	2.4	11	4	8 1/5 x 1/2 x 7 7/8	
	1075/3	115	48Y	X056	48A11O901	✓	\$146	F1	2.4	13	4	8 1/5 x 1/2 x 7 7/8	71
	1075/3	208-230	48Y	X065	48A11O2012	✓	\$132	F1	1.0	11	4	8 1/5 x 1/2 x 7 7/8	
	1075/3	208-230	48Y	X057	48A11O900		\$146	F1	1.0	33	4	8 1/5 x 1/2 x 7 7/8	71
1/6	1075/3	115	48Y	X048	48A11O772		\$133	F1	3.0	14	4	8 1/5 x 1/2 x 7 7/8	
	1075/3	115	48Y	X042	48A11O653	✓	\$149	F1	3.0	11	4	8 1/5 x 1/2 x 7 7/8	71
	1075/3	208-230	48Y	X049	48A11O773	✓	\$133	F1	1.5	9	4	8 1/5 x 1/2 x 7 7/8	
	1075/3	208-230	48Y	X043	48A11O654	✓	\$149	F1	1.5	11	4	8 1/5 x 1/2 x 7 7/8	71
1/4	1625/3	208-230	48Y	X059	48A17O2002		\$147	F1	1.8	12	4 1/4	8 x 1/2 x 7 7/8	
	1625/3	208-230	48Y	X040	48A17O69	✓	\$163	F1	1.8	12	4 1/4	8 x 1/2 x 7 7/8	71
	1075/3	115	48Y	X061	48A11O2022	✓	\$159	F1	4.8	14	4 1/4	8 x 1/2 x 7 7/8	71
	1075/3	208-230	48Y	X050	48A11O774	✓	\$143	F1	2.2	13	4 1/4	8 x 1/2 x 7 7/8	
	1075/3	208-230	48Y	X044	48A11O655	✓	\$159	F1	2.2	16	4 1/4	8 x 1/2 x 7 7/8	71
1/3	1625/3	208-230	48Y	X060	48A17O2003		\$158	F1	2.5	14	4 3/4	7 1/2 x 1/2 x 7 7/8	
	1625/3	208-230	48Y	X041	48A17O70	✓	\$172	F1	2.5	15	4 3/4	7 1/2 x 1/2 x 7 7/8	71
	1075/3	115	48Y	X070	48A11O2024	✓	\$168	F1	7.8	15	4 3/4	7 1/2 x 1/2 x 7 7/8	71
	1075/3	208-230	48Y	X052	48A11O775	✓	\$152	F1	3.4	16	4 3/4	7 1/2 x 1/2 x 7 7/8	
	1075/3	208-230	48Y	X045	48A11O656	✓	\$168	F1	3.4	17	4 3/4	7 1/2 x 1/2 x 7 7/8	71
	1075/3	208-230	48Y	X258	48A11O1167	✓	\$147	F1	2.3	14	4 1/4	6 7/8 x 1/2 x 6 7/8	
1/2	1625/3	208-230	48Y	X058	48A17O2001	✓	\$194	F1	4.1	18	5 1/4	7 x 1/2 x 7 7/8	71
	1625/3	208-230	48Y	X069	48A17O2004		\$177	F1	4.1	16	5 1/4	7 x 1/2 x 7 7/8	
	1075/3	115	48Y	X071	48A11O2026	✓	\$189	F1	9.4	20	5 1/2	6 5/8 x 1/2 x 7 7/8	71
	1075/3	208-230	48Y	X062	48A11O2009	✓	\$189	F1	4.7	17	5 1/2	6 5/8 x 1/2 x 7 7/8	71
3/4	1075/3	208-230	48Y	X067	48A11O2014	✓	\$173	F1	4.7	19	5 1/2	6 5/8 x 1/2 x 7 7/8	
	1075/3	208-230	48Y	X068	48A11O2015		\$197	F1	5.0	15	5 3/4	6 3/4 x 1/2 x 6 7/8	
	1075/3	208-230	48Y	X063	48A11O2028	✓	\$212	F1	5.4	19	5 1/2	6 5/8 x 1/2 x 7 7/8	71

# Fan and Blower, Split Phase, Dripproof Resilient Base (Single & Two-Speed)



HVAC / AIR MOVING

**Features:**

- Ball bearings (except as noted)
- Service factor, as noted
- Thermal protection, as noted
- Variable torque on two speed motors
- Extended thru-bolts, as noted
- Heavy gauge steel frame and base
- 48Y and 48YZ frame have 48/56 frame mounting holes
- UL Recognized and CSA certified

HP	RPM	VOLTS	FRAME	OVER LOAD	CAT. NO.	MODEL NO.	STOCK	LIST PRICE	MULT. SYMB.	F.L. AMPS	WEIGHT	"C" DIM.	FOOT NOTES
1/12	1140	115	48Z	AUTO	HG152	5KH32GN140X	✓	\$247	F1	2.4	15	9.32	8,112
1/8	1140	115	48Z	AUTO	HG154	5KH36KN113X	✓	\$273	F1	3.8	17	10.38	8,112
	850	115	56	AUTO	HG155	5KH46MN3021X	✓	\$439	F1	4.6	32	10.88	112
1/6	1725/1140	115	48Z	NONE	H169	5KH36KN114	✓	\$170	F1	3.4/1.9	17	10.38	8,20,54
	1725/1140	115	48Z	AUTO	H170	5KH36KN114X	✓	\$177	F1	3.4/1.9	17	10.38	8,20,54
	1725/1140	115	48	NONE	4322	5KH39QN9548	✓	\$204	F1	3.4/1.9	15	10.00	20
	1725/1140	115	48	AUTO	4389	5KH39QN9548X	✓	\$217	F1	3.4/1.9	18	10.00	20
	1725	115	48	AUTO	4314	5KH39QN5520X	✓	\$147	F1	3.9	12	8.93	4,20
	1725	115	48Y	AUTO	D107	48S17D2017	✓	\$151	F1	3.6	12	8.99	CF,20
	1725	115	48	NONE	4304	5KH39QN5543	✓	\$146	F1	3.9	12	8.93	20
	1725	115	48Z	AUTO	H913	5KH32DNA700X		\$155	F1	4.4	12	9.74	9,20,28
	1725	115	48Z	NONE	HG156	5KH32DN3085	✓	\$143	F1	3.9	12	9.32	8,20
	1725	115	48Z	NONE	H912	5KH32DNA700		\$105	F1	4.4	12	9.74	9,20,28
	1725	115	48YZ	NONE	B300	48S17D2052	✓	\$145	F1	3.6	13	9.32	CF,20,31,52
	1725	115	48Z	AUTO	H157	5KH32DN3085X	✓	\$151	F1	3.9	12	9.32	8,20
	1725	115	48YZ	AUTO	B322	48S17D2053	✓	\$153	F1	3.6	13	9.32	CF,20,31,52
	1725	115	56Z	AUTO	4350	5KH39QN5538X	✓	\$154	F1	3.9	13	9.19	8,20,26
	1140	115	48	NONE	H112	5KH37PN39	✓	\$242	F1	4	20	10.40	20
	1140	115	48Z	AUTO	H159	5KH37PNA41X	✓	\$300	F1	4	21	10.78	8,20
	1140	115	48	NONE	HG695	5KH37PNA233	✓	\$244	F1	4	24	10.40	20
	1140	115	48Z	NONE	H158	5KH37PN41	✓	\$293	F1	4	21	10.78	8,20
	1140	115	48	AUTO	HG113	5KH37PN39X	✓	\$250	F1	4	20	10.40	20
	850	115	56	NONE	H620	5KH49PN3043	✓	\$487	F1	6.1	31	11.48	20
1/4	1725/1140	115	48Y	AUTO	D180	48S17D7204		\$185	F1	4.1/2.5	18	10.06	20
	1725/1140	115	48Z	AUTO	H172	5KH37PN33X	✓	\$203	F1	4.2/2.7	21	10.69	8,20,54
	1725/1140	115	48Z	NONE	H171	5KH37PN33	✓	\$196	F1	4.2/2.7	21	10.69	8,20,54
	1725/1140	115	48	AUTO	4399	5KH39QN9551X	✓	\$250	F1	4.2/2.7	22	10.40	20,54
	1725/1140	115	56Z	AUTO	HG704	5KH35MNA568T	✓	\$255	F1	5.2/2.8	17	10.18	17,20,48
	1725/1140	230	48	AUTO	4412	5KH39QN9550X	✓	\$281	F1	2.1/1.3	22	10.40	20,39
	1725	115	48	AUTO	4305	5KH39QN5511X	✓	\$130	F1	5.1	13	8.93	20
	1725	115	48	NONE	4355	5KH39QN5225	✓	\$154	F1	5.1	13	8.93	20,47
	1725	115	48Y	AUTO	4701	5KH39QN5512T	✓	\$128	F1	5.1	12	9.12	CF,20,53
	1725	115	48YZ	AUTO	B206	48S17D2107	✓	\$134	F1	5	14	9.62	9,8,20
	1725	115	48Z	NONE	H160	5KH32FN3083	✓	\$153	F1	5.1	14	9.32	CF,20,31,52
	1725	115	48YZ	NONE	B302	48S17D2054	✓	\$156	F1	5	14	9.57	9,20,28
	1725	115	48Z	AUTO	H915	5KH33FNA722X	✓	\$167	F1	5.6	14	9.99	7,20,26
	1725	115/230	48Y	AUTO	4702	5KH33HN5725X	✓	\$162	F1	5.2/2.6	15	9.62	20,48
	1725	115	48Y	AUTO	HG701	5KH32DN5618X	✓	\$139	F1	5.1	13	8.94	9,20
	1725	115/208-230	48Z	AUTO	4680	5KH32FN3120T	✓	\$219	F1	5.0/2.5	13	9.94	8,20
	1725	115	48Z	AUTO	HG161	5KH32FN3083X	✓	\$160	F1	5.1	14	9.32	CF,20,31,52
	1725	115	48YZ	AUTO	B303	48S17D2055	✓	\$163	F1	5	14	9.57	20,32,53
	1725	115	56Z	AUTO	B201	56S17D2047	✓	\$134	F1	5	14	9.47	8,20,26
	1725	115	56Z	AUTO	4363	5KH39QN5526X	✓	\$176	F1	5.1	14	9.19	20
	1725	230	48	AUTO	4306	5KH39QN5537X	✓	\$139	F1	2.5	13	9.09	20
	1725	230	48	NONE	4360	5KH39QN5548	✓	\$170	F1	2.5	13	8.93	20,31,52
	1725	277	48YZ	NONE	B606	48S17D2116	✓	\$174	F1	2.1	13	9.47	20,31
	1140/850	115	56	NONE	H300	5KH49SN3048	✓	\$514	F1	5.8/3.6	30	12.01	20
	1140	115	56	AUTO	H163	5KH46MN6053X	✓	\$356	F1	5.6	23	10.88	20
	1140	115	56	NONE	H162	5KH46MN6053	✓	\$348	F1	5.6	27	10.88	19
	850	115	56	NONE	H296	5KH49SN3046	✓	\$598	F1	6.9	30	12.01	20
1/3	3450	115	48	NONE	H114	5KH35FN124	✓	\$198	F1	5.6	15	9.57	20
	3450	115	48	AUTO	HG115	5KH35FN124X	✓	\$211	F1	5.6	15	9.57	9,20
	3450	115/230	48Z	AUTO	4798	5KH35FN153T	✓	\$230	F1	6.8/3.4	13	10.25	9,20

# Fan and Blower, Split Phase, Dripproof

## Resilient Base (Single & Two-Speed)

HP	RPM	VOLTS	FRAME	OVER LOAD	CAT. NO.	MODEL NO.	STOCK	LIST PRICE	MULT. SYMB.	F.L. AMPS	WEIGHT	"C" DIM.	FOOT NOTES	
1/3	1725/1140	115	48	AUTO	4319	5KH39QN9429T	✓	\$256	F1	6.3/3.1	22	10.40	d,4,17,54	
	1725/1140	115	48	NONE	4396	5KH39QN9683	✓	\$246	F1	6.3/3.1	21	10.40	17,54	
	1725/1140	115	48Y	AUTO	D181	48S17D7205	✓	\$230	F1	5.3/2.9	20	10.06	20	
	1725/1140	115	56	NONE	H173	5KH46MN3025	✓	\$247	F1	5.7/3.2	24	10.88	20,31	
	1725/1140	115	56	AUTO	H174	5KH46MN3025X	✓	\$254	F1	5.7/3.2	32	10.88	20,31	
	1725/1140	115	56Z	AUTO	HG706	5KH37PNA569T	✓	\$292	F1	6.0/3.8	20	11.01	17,48	
	1725/850	115	56Z	AUTO	HG705	5KH46NN3039T	✓	\$444	F1	4.7/2.6	25	10.90	17,48	
	1725	115	48Y	AUTO	D143	48S17D2086	✓	\$152	F1	6.1	15	9.34	20	
	1725	115	48Y	AUTO	B703	48N17D14	✓	\$204	F1	3.2	17	9.84	20,74	
	1725	115	48Y	AUTO	HG711	5KH32HNN5620T	✓	\$149	F1	6.6	14	8.94	d,4,20,26,48	
	1725	115	48Y	AUTO	HG700	5KHC37NNA167T	✓	\$261	F1	3.7	24	10.39	ES,20,26,47	
	1725	115	48Y	AUTO	4706	5KH39QN5514T	✓	\$142	F1	6.6	15	9.12	d,4,20,47	
	1725	115	48YZ	AUTO	B207	48S17D2108	✓	\$152	F1	5.5	15	9.62	CF,20,53	
	1725	115	48Z	NONE	H164	5KH32JN3128	✓	\$177	F1	6.2	15	9.32	8,20	
	1725	115	48YZ	NONE	B304	48S17D2056	✓	\$180	F1	5.5	15	9.32	CF,20,31,52	
	1725	115	48Z	AUTO	H917	5KH35JNA723X	✓	\$190	F1	6.9	15	10.37	9,20,28	
	1725	115	48Z	AUTO	H165	5KH32JN3128X	✓	\$183	F1	6.2	16	9.32	8,20	
	1725	115	48YZ	AUTO	B305	48S17D2057	✓	\$186	F1	5.5	15	9.32	CF,20,31,52	
	1725	115	56Z	AUTO	B202	56S17D2048	✓	\$156	F1	6.1	15	9.72	20,32,53	
	1725	230	48Z	AUTO	H167	5KH35JN26X	✓	\$160	F1	3.3	16	9.95	8,20	
	1725	230	48	AUTO	4309	5KH39QN9514X	✓	\$232	F1	3.1	15	9.18	20	
	1725	115	48	NONE	4370	5KH39QN9682	✓	\$213	F1	6.2	15	9.18	20	
	1725	115/208-230	56Z	AUTO	4682	5KH35JN3132T	✓	\$246	F1	6.2/3.1	16	10.26	9,20,26,72	
	1725	230	48Z	NONE	H166	5KH35JN26	✓	\$235	F1	3.3	16	9.95	8,20	
	1725	230	56Z	AUTO	4757	5KH39QN9636T	✓	\$243	F1	3.1	16	9.19	7,20,26	
	1725	277	48YZ	NONE	B607	48S17D2117	✓	\$196	F1	2.5	15	9.72	20,31,52	
	1725	115	56Z	AUTO	4383	5KH39QN9513X	✓	\$228	F1	6.2	15	9.19	8,26	
	1140	115/230	56	NONE	H168	5KH49PN6055	✓	\$404	F1	7.0/3.5	27	11.48	20	
	1140	115/230	56	AUTO	HG621	5KH49PN6055X	✓	\$419	F1	7.0/3.5	26	11.48	20	
	1/2	1725/1140	115	56	NONE	H175	5KH49PN3026	✓	\$312	F1	8.0/4.2	31	11.48	19,31
		1725/1140	115	56	AUTO	H176	5KH49PN3026X	✓	\$319	F1	8.0/4.2	31	11.48	19,31
		1725/1140	115	56	NONE	H130	5KH39QN9632	✓	\$350	F1	8.4/4.8	22	10.32	17
		1725/1140	115	56	AUTO	H131	5KH39QN9631T	✓	\$362	F1	8.4/4.8	22	10.32	17,31
		1725/1140	115	56Z	AUTO	HG715	5KH38SNA731T	✓	\$412	F1	7.8/4.8	25	11.44	17,48
		1725/1140	230	56	NONE	H275	5KH49PN3045	✓	\$436	F1	3.8/1.9	28	11.48	19,31
		1725/1140	230	56	AUTO	H133	5KH39QN9642T	✓	\$378	F1	4.1/2.4	22	10.32	17,31
		1725	115	48Y	AUTO	D162	48S17D2087	✓	\$207	F1	7.2	19	10.09	19
		1725	115	48Y	AUTO	HG703	5KH35MNA519T	✓	\$200	F1	7.9	15	10.32	19,48
		1725	115	48Y	AUTO	4708	5KH39QN9401T	✓	\$188	F1	7.9	17	9.93	d,4,19,47
		1725	115	48YZ	AUTO	B208	48S17D2109	✓	\$207	F1	7.5	20	10.43	CF,19,53
1725		115	48YZ	NONE	B306	48S17D2058	✓	\$218	F1	7.5	18	10.32	CF,19,31,52	
1725		115	48	AUTO	HG694	5KH39QN9767X	✓	\$231	F1	7.1	19	9.99	19	
1725		115	48YZ	AUTO	B307	48S17D2059	✓	\$237	F1	7.5	18	10.32	CF,19,31,52	
1725		115	56Z	AUTO	H919	5KH36MNA735X	✓	\$234	F1	8.7	18	10.80	10,19,28	
1725		115	56	AUTO	4392	5KH39QN9405X	✓	\$230	F1	7.9	21	10.32	19	
1725		115	56	NONE	4390	5KH39QNA039	✓	\$258	F1	7.9	17	10.32	19	
1725		115	56	AUTO	D149	56S17D2050	✓	\$212	F1	7.2	19	10.47	19	
1725		115	56	AUTO	H248	5KH36MN3106X	✓	\$262	F1	9.3	18	10.32	19	
1725		115	56	NONE	H286	5KH36MN3106	✓	\$258	F1	9.3	18	10.32	19	
1725		115	56Z	AUTO	B200	56S17D2049	✓	\$212	F1	7.2	19	10.47	19,32,53	
1725		115	56Z	AUTO	4758	5KH39QN9698T	✓	\$269	F1	7.9	22	9.99	7,19,26	
1725		115/230	56	AUTO	B100	56S17D2064	✓	\$223	F1	7.2/3.6	20	10.47	19	
1725		115/230	56Z	AUTO	4684	5KH36MN3127T	✓	\$304	F1	8.9/4.5	18	10.69	9,26	
1725		230	56	AUTO	4393	5KH39QN9544X	✓	\$281	F1	4.5	21	10.32	19	
1725		230	48Y	AUTO	D163	48S17D2088	✓	\$217	F1	3.6	19	10.09	19	
1140		115/230	56	AUTO	H298	5KH48UN6054X	✓	\$536	F1	9.0/4.5	32	12.76	19	
3/4		1725	115	56	AUTO	4338	5KH39QN9541T	✓	\$275	F1	11.4	21	10.72	18



# Fan and Blower - Capacitor Start, Dripproof Resilient Base (Single & Two-Speed)

## Features:

- Ball bearings
- Heavy gauge steel frame and base
- Service Factor, as noted
- Capacitor start / capacitor run as noted
- Thermal protection, as noted
- 48Y and 48YZ Frame have 48/56 Frame mounting holes
- UL Recognized and CSA Certified



HP	RPM	VOLTS	FRAME	OVER LOAD	CAT. NO.	MODEL NO.	STOCK	LIST PRICE	MULT. SYMB.	F.L AMPS	WEIGHT	"C" DIM.	FOOT NOTES
1/4	1725	115/230	48	NONE	G1114	5KC35JN7J	✓	\$173	F1	5.2/2.6	16	9.57	20
	1725	115/208-230	48YZ	AUTO	B313	48C17D2042	✓	\$203	F1	5.2/2.8-2.6	16	9.95	CF,20,31,52
	1725	115/208-230	48YZ	NONE	B312	48C17D2041	✓	\$194	F1	6.2/2.8-3.1	15	9.72	20,31,52
1/3	1725	115/230	48	AUTO	G1115	5KC35JN7X	✓	\$183	F1	5.2/2.6	16	9.57	20
	1725	115/208-230	48YZ	NONE	B314	48C17D2043	✓	\$229	F1	5.8/3.1-2.9	18	10.22	20,31,52
	1725	115/208-230	48YZ	AUTO	B315	48C17D2044	✓	\$237	F1	5.8/3.1-2.9	17	10.22	20,31,52
	1725	115/208-230	56	AUTO	C216	5KC36LN1X	✓	\$241	F1	6.0/3.2-3.0	18	10.32	20,50
	1725	115/230	48YZ	AUTO	D119	48C17D2055	✓	\$218	F1	5.8/2.9	12	10.22	20,31,52
	1725	115/230	56	AUTO	G135	56C17D2088	✓	\$221	F1	6.4/3.2	18	10.22	20
1/2	3450	115/208-230	48	AUTO	C1152	5KC39QN3220X	✓	\$175	F1	8.2/3.9-4.1	19	11	19
	1725/1140	115	56	AUTO	C419	5KC49PN3027X	✓	\$499	F1	8.2/3.9	28	11.38	19
	1725	115/208-230	56	NONE	B1316	5KC49GN0001	✓	\$259	F1	8.8/4.2-4.4	21	10.38	19
	1725	115/208-230	56	AUTO	C1153	5KC49GN0022X	✓	\$293	F1	8.6/4.1-4.3	21	10.38	19
	1725	115/208-230	56	AUTO	B317	56C17D2072	✓	\$299	F1	8.0/4.1-4.0	20	10.32	CF,19,31
	1725	115/208-230	56Y	AUTO	B353	56B17D67	✓	\$320	F1	6.2/3-3.1	24	12.92	1,19,55
	1725	115/230	56	AUTO	D111	56C17D2079	✓	\$263	F1	7.2/3.6	20	10.72	19
	1725	115/230	56	AUTO	G151	56C17D2025	✓	\$263	F1	8.6/4.3	24	11.72	19
	1725	277	56	NONE	B608	56C17D2113	✓	\$296	F1	3.6	23	11.72	19
	3/4	3450	115/208-230	56	AUTO	C1155	5KC38NN410X	✓	\$229	F1	10.0/4.9-5.0	17	11.32
3450		115/208-230	48	AUTO	C1154	5KC38NN413X	✓	\$322	F1	9.8/5.0-4.9	17	11	19
1725/1140		115	56	AUTO	B332	56B17D5701	✓	\$473	F1	8.9/6.1	40	12.85	1,19,31
1725/1140		115	56	NONE	C420	5KCR49PN3011	✓	\$463	F1	9.0/6.4	31	11.48	ES,1,19
1725/1140		208-230	56	NONE	C486	5KCR49PN3012X	✓	\$472	F1	4.3-4.4/3.1-3.2	38	11.48	ES,1,19
1725/1140		115	56	AUTO	C474	5KCR49PN3011X	✓	\$545	F1	9.0/6.4	31	11.48	ES,1,19
1725		115/208-230	56	AUTO	C1156	5KC46LN0149X	✓	\$353	F1	13.3/6.5-6.6	27	10.78	19
1725		115/208-230	56	AUTO	B319	56C17D2074	✓	\$363	F1	10.0/5.2-5.0	23	10.72	CF,19,31
1725		115/208-230	56	NONE	CG230	5KC46LN0158	✓	\$326	F1	13.2/6.2-6.6	25	10.78	19
1725		115/208-230	56	NONE	B318	56C17D2073	✓	\$337	F1	10.0/5.2-5.0	24	10.72	CF,19,31
1725		115/208-230	56	NONE	G156	56B17D2012	✓	\$324	F1	11.0/5.5-5.5	26	11.47	1,19
1725		115/208-230	56Z	AUTO	4686	5KC46LN0269X	✓	\$385	F1	13.3/6.5-6.6	25	11.15	10,19
1725		115/230	56	AUTO	D1113	5KC46LN0158X	✓	\$325	F1	13.2/6.6	25	10.78	19
1725		277	56	NONE	B609	56B17D2013	✓	\$360	F1	4.3	27	11.47	1,19,31
1		3450	115/208-230	56	AUTO	C1157	5KC39RN383X	✓	\$284	F1	13.4/6.7-6.6	25	11.85
	3450	115/208-230	56	AUTO	D118	56C34D2106	✓	\$266	F1	12.0/6.2-6.0	25	12.22	18
	1725/1140	115	56	AUTO	B335	56B17D5703	✓	\$589	F1	11.5/7.0	39	12.85	1,18,31
	1725/1140	115	56	NONE	C475	5KCR49SN3009	✓	\$578	F1	10.8/7.4	35	12.01	ES,1,18
	1725/1140	115	56	AUTO	C1478	5KCR49SN3009X	✓	\$604	F1	10.8/7.4	30	12.01	ES,1,18
	1725/1140	208-230	56	NONE	C476	5KCR49SN3010	✓	\$601	F1	5.3-5.4/3.6-3.7	35	12.01	ES,1,18
	1725/1140	208-230/190-380	56H	AUTO	C1479	5KCR48TN3084X	✓	\$613	F1	5.3-5.4/3.6-3.7	36	12.54	ES,1,17
	1725	115/208-230	56	AUTO	C1158	5KC49PN0164X	✓	\$369	F1	14.7/7.2-7.4	29	11.38	18
	1725	115/208-230	56Z	AUTO	4688	5KC49NN0061T	✓	\$374	F1	14.4/7.2-7.4	28	11.75	10,18
	1725	115/208-230	56H	NONE	C235	5KC49PN0155	✓	\$344	F1	13.6/6.7-6.8	31	11.38	18
	1725	277	56	NONE	B337	56C17D5348	✓	\$386	F1	5.6	29	11.85	19,32
	1 1/2	3450	115/208-230	56H	AUTO	D115	56B34D2027	✓	\$370	F1	13.4/7.4-6.7	28	11.72
1725		115/208-230	145T	NONE	I146	145TCDR5331	✓	\$419	S1	18.0/9.3-9.0	42	13.22	18,32
1725		115/208-230	56H	NONE	B336	56C17D5347	✓	\$413	F1	18.0/9.3-9.0	39	12.85	5,18,32
1725		115/208-230	56H	AUTO	C1160	5KCR49SN0150X	✓	\$429	F1	16.4/8.4-8.2	35	11.91	ES,1,18
1725		277	56H	NONE	B338	56C17D5349	✓	\$447	F1	7.5	41	12.85	5,18,32
2	3450	115/208-230	56H	AUTO	C1161	5KCR49RN2148T	✓	\$451	F1	19.6/10.4-9.8	33	11.91	ES,1,110
	1725	115/208-230	56H	AUTO	B352	56B17D5331	✓	\$547	F1	21/11.3-10.5	50	13.85	1,5,32
	1725	115/208-230	145T	NONE	I147	145TBDR5345	✓	\$440	S1	21/11.3-10.5	49	14.22	1,18

# Fan and Blower, Split Phase and Capacitor Start

## Totally Enclosed, Resilient Base (Single & Two-Speed)

### Features:

- Thermal protection, as noted
- 1.0 Service Factor (except as noted)
- Heavy gauge steel frame and base
- Split phase (except as noted)
- Ball bearings
- UL Recognized and CSA Certified



HP	RPM	VOLTS	FRAME	OVER LOAD	CAT. NO.	MODEL NO.	STOCK	LIST PRICE	MULT. SYMB.	F.L. AMPS	WEIGHT	"C" DIM.	FOOT NOTES
1/6	1725	115	48	NONE	HG178	5KH32EN79	✓	\$242	F1	4.0	15	9.92	
	1725	115	48	AUTO	H291	5KH32EN72X	✓	\$255	F1	4.0	15	9.92	CF,20,31,52
	1140	115	48	NONE	H233	5KH36PN109	✓	\$335	F1	4.0	23	10.98	
1/4	1725	115	48	AUTO	H234	5KH39QN9105X	✓	\$177	F1	5.1	17	9.92	
	1725	115	48	NONE	B1502	5KH39QN9105	✓	\$170	F1	5.1	17	9.92	
	1725	115/230	48	NONE	C247	5KC32GN13	✓	\$300	F1	5.4/2.7	17	9.92	2
	1725/1140	115	48	NONE	HG189	5KH36PN108	✓	\$335	F1	4.2/2.7	23	10.98	
	1140	115/230	56	NONE	HG182	5KH49MN6060	✓	\$386	F1	5.6/2.8	25	11.54	
1/3	1725	115	56	NONE	B1504	5KH35MN56	✓	\$210	F1	5.9	20	10.93	
	1725	115	56	AUTO	H236	5KH35MN56X	✓	\$217	F1	5.9	20	10.93	
	1725/1140	115	56	NONE	H190	5KH49MN3035	✓	\$416	F1	5.7/3.2	27	11.54	
	1140	115	56	NONE	HG186	5KH46PN6059	✓	\$444	F1	7.0	31	11.94	
1/2	1725	115	56	AUTO	B506	56S17F5303		\$298	F1	8.4	27	12.30	
	1725	115	56	NONE	B1507	5KH42GN0336	✓	\$252	F1	8.0	21	11.11	19
	1725	115/230	56	AUTO	C289	5KC42GN0309X	✓	\$405	F1	8.6/4.3	21	11.11	2,18
	1725/1140	115	56	NONE	HG191	5KH46PN3033	✓	\$463	F1	8.0/4.2	29	11.94	
	1725/1140	230	56	NONE	H293	5KH46PN3034	✓	\$475	F1	3.8/1.9	31	11.94	
	1140	115	56	NONE	HG188	5KH49UN6064	✓	\$565	F1	9.0	40	13.07	
3/4	1725	115/230	56	AUTO	C806	5KC49PN0281X	✓	\$471	F1	11.0/5.5	32	12.54	2,17
1	1725	115/230	56	AUTO	C292	5KC49TN0285X	✓	\$520	F1	13.2/6.6	38	13.07	2

## Fan & Blower - Three Phase

### TEAO, Resilient Base

#### Applications:

Designed for applications like commercial fans and blowers, direct and belt drive air handlers and exhaust fans.

#### Features:

- Ball bearings
- 1.0 Service Factor
- .62" extended thru-bolts
- UL Recognized and CSA Certified



HP	RPM	VOLTS	FRAME	CAT. NO.	MODEL NO.	STOCK	LIST PRICE	MULT. SYMB.	F.L. AMPS	WEIGHT	"C" DIM.	FOOT NOTES
1/4	1800	230/460	48	K281	5K32GN48	✓	\$282	F1	1.4/0.7	14	8.94	
	1200	230/460	56	K282	5K35MN294	✓	\$405	F1	1.4/0.7	18	9.89	
1/3	1800	230/460	48	K283	5K33KN52	✓	\$316	F1	1.5/0.8	16	9.19	
1/2	1800	208-230/460	56	K284	5K42HN4128	✓	\$355	F1	2.3-2.2/1.1	22	10.05	
	1200	208-230/460	56	K285	5K49MN6080	✓	\$475	F1	2.6-2.6/1.3	24	10.48	
	1200	208-230/460	56	K541	5K49MN6081	✓	\$514	F1	2.6-2.6/1.3	27	11.54	
3/4	1800	208-230/460	56	K286	5K49KN4142	✓	\$383	F1	3.3-3.0/1.5	21	10.48	
1	1800	208-230/460	56	K525	5K49MN4114	✓	\$402	F1	3.6-3.8/1.9	25	10.48	

# Fan & Blower - Three Phase, Dripproof Resilient Base (Single and Two-Speed)

## Features:

- Single and two-speed models, as noted
- Variable torque on two speed ratings
- Ball bearings
- Heavy gauge steel frame and base
- Thermal protection, as noted
- Service Factor, as noted
- Nameplated 60/50 Hz at next lower horsepower (except as noted)
- Patented VCD™, Voltage Change Device where footnoted "VC"
- UL Recognized and CSA Certified

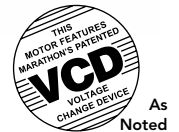

HP	RPM	VOLTS	FRAME	OVER LOAD	CAT. NO.	MODEL NO.	STOCK	LIST PRICE	MULT. SYMB.	F.L. AMPS	WEIGHT	"C" DIM.	FOOT NOTES
1/4	1800	230/460	48Z	NONE	K275	5K33GN45	✓	\$267	F1	1.4/0.7	14	9.57	20
1/3	1800/1200	460	56	NONE	G161	56T17D5701		\$352	F1	0.6/0.4	33	12.35	20
	1800	208-230/460	56	AUTO	G106	56T17D2104	✓	\$280	F1	1.5-1.6/8	16	9.97	20
	1800	208-230/460	56	NONE	G162	56T17D2121	✓	\$232	F1	1.5-1.6/8	16	9.97	20
1/2	1800	575	56	NONE	G964	56T17D2117		\$232	F1	0.64	16	9.97	20,70
	1800/1200	200-230	56	NONE	K544	5K42JN3051	✓	\$382	F1	2.4-2.8/1.5-1.7	23	10.05	19
	1800/1200	460	56	NONE	K546	5K42JN3050	✓	\$382	F1	1.1/0.6	22	10.05	19
	1800	208-230/460	56	AUTO	K1408	5K42HN4089X	✓	\$310	F1	2.3-2.2/1.1	20	10.05	19
	1800	208-230/460	56	NONE	K381	5K42HN4089	✓	\$262	F1	2.3-2.2/1.1	20	10.05	19
	1800	208-230/460	56	AUTO	G140	56T17D5345	✓	\$324	F1	2.3-2.4/1.2	22	10.85	VC,19
3/4	1800	575	56	NONE	G961	56T17D2118	✓	\$261	F1	0.9	18	10.47	19,70
	3600	208-230/460	56	AUTO	K1409	5K37MN252X	✓	\$284	F1	2.6-2.6/1.3	16	10.72	19
	1800/1200	200-230	56	NONE	K279	5K49PN3053	✓	\$454	F1	2.8-3.0/1.6-1.8	31	11.48	19
	1800/1200	460	56	NONE	K280	5K49PN3052	✓	\$454	F1	1.3/0.7	28	11.48	19
	1800	208-230/460	56	AUTO	K1410	5K46KN4085X	✓	\$339	F1	3.3-3.0/1.5	21	10.88	19
	1800	208-230/460	56	AUTO	G141	56T17D5346	✓	\$354	F1	2.9-3.0/1.5	23	10.85	VC,19
1	1800	208-230/460	56	NONE	K277	5K46KN4085	✓	\$293	F1	3.3-3.0/1.5	25	10.88	19
	1800	575	56	NONE	G962	56T17D2119	✓	\$292	F1	1.1	21	10.97	19,70
	3600	208-230/460	56	AUTO	K1411	5K38PN258X	✓	\$316	F1	3.3-3.2/1.6	18	11.32	19
	1800/1200	200-230	56	NONE	K518	5K49SN3054	✓	\$470	F1	3.7-3.9/2.0-2.2	35	12.01	18
	1800/1200	460	56	NONE	K519	5K49SN3055	✓	\$470	F1	1.8/1.1	35	12.01	18
	1800	208-230/460	56	AUTO	K1412	5K46MN4087X		\$360	F1	3.6-3.8/1.9	27	10.88	18
	1800	208-230/460	56	AUTO	G142	56T17D5347	✓	\$360	F1	3.5-3.6/1.8	25	11.35	VC,18
	1800	208-230/460	56H	AUTO	G100	56T17D2101	✓	\$346	F1	3.4-3.4/1.7	24	11.47	5,18
1 1/2	1800	208-230/460	56	NONE	K278	5K46MN4087	✓	\$301	F1	3.6-3.8/1.9	27	10.88	18
	1800	575	56H	NONE	G963	56T17D2120	✓	\$300	F1	1.4	23	11.47	5,18,70
	3600	208-230/460	56H	AUTO	K1413	5K49KN2150X	✓	\$377	F1	5.0-4.8/2.4	26	12.01	18
	1800/1200	200-230	56H	NONE	K520	5K48UN3056	✓	\$484	F1	5.0-5.3/2.8-3.1	40	12.76	18
	1800/1200	460	56H	NONE	K549	5K48UN3057	✓	\$484	F1	2.3/1.4	40	12.76	18
	1800	208-230/460	56	NONE	G122	56T17D5329	✓	\$333	F1	4.8-4.8/2.4	28	11.35	18
	1800	208-230/460	56H	AUTO	K1415	5K49PN4088X	✓	\$378	F1	5.5-5.6/2.8	31	12.01	18
	1800	208-230/460	56	AUTO	G143	56T17D5348	✓	\$393	F1	4.8-4.8/2.4	28	11.35	VC,18
2	1800	208-230/460	145T	AUTO	K2030	5KE49TN8384T		\$409	E6	4.5-4.4/2.2	40	13.19	18,70
	1800	575	56H	AUTO	G965	56T17D5357		\$377	F1	1.9	29	11.35	18,70
	3600	208-230/460	56H	AUTO	K1416	5K49NN2147X	✓	\$435	F1	6.0-6.0/3.0	30	12.01	18
	1800	208-230/460	56H	AUTO	G144	56T17D5349	✓	\$435	F1	6.2-6.2/3.1	35	12.35	VC,5,18
3	1800	208-230/460	56H	NONE	G127	56T17D5332	✓	\$364	F1	6.2-6.2/3.1	34	12.35	5,18
	1800	208-230/460	56H	AUTO	K1418	5K49UN4086X	✓	\$412	F1	6.2-6.0/3.0	39	13.96	18
	1800	575	56H	AUTO	G967	56T17D5385		\$411	F1	2.5	36	12.35	5,18,70
	3600	208-230/460	56HZ	AUTO	B193	56T34D5357	✓	\$488	F1	8.9-8.4/4.2	34	12.22	Z,5,18
	3600	208-230/460	145T	AUTO	K2037	5KE49UN8376T	✓	\$476	E6	8.4-7.6/3.8	34	13.19	d,18,70
	1800	208-230/460	56HZ	AUTO	G145	56T17D5350	✓	\$458	F1	9.2-8.6/4.3	48	14.22	Z,VC,5,18
5	1800	208-230/460	56HZ	AUTO	K1497	5K49WN4335X	✓	\$508	F1	10.2/4.8	44	15.31	11,18
	3600	208-230/460	56HZ	AUTO	X251	56T34D5364	✓	\$654	F1	13.5-12.4/6.2	50	13.49	Z,5,12,17,70
	3600	230/460	145T	AUTO	K2038	5KE49QN8375T	✓	\$541	E6	12.4/6.2	54	14.19	d,17,70

# Exhaust Ventilator, Single Phase

## Dripproof, C-Face Footless, Single Speed

### Features:

- Split phase (except as noted)
- Thermal protection, as noted
- Service Factor, as noted
- Motors with 56CZ frames have 2-1/4 x 5/8 shaft dimensions
- Ball Bearings



HP	RPM	VOLTS	FRAME	OVER LOAD	CAT. NO.	MODEL NO.	STOCK	LIST PRICE	MULT. SYMB.	F.L. AMPS	WEIGHT	"C" DIM.	FOOT NOTES
1/12	1140	115	56CZ	NONE	H204	5KH32GN142	✓	\$247	F1	2.4	13	9.62	112
	850	115	56CZ	NONE	H205	5KH37PN37	✓	\$358	F1	3.2	19	11.08	112
	850	115	56CZ	AUTO	H278	5KH37PN37X	✓	\$367	F1	3.2	19	11.08	112
1/8	1140	115	56CZ	AUTO	H287	5KH36KN112X	✓	\$285	F1	3.8	15	10.68	112
	1140	115	56CZ	NONE	H206	5KH36KN112	✓	\$271	F1	3.8	15	10.68	112
	850	115	56CZ	NONE	H207	5KH46MN3041	✓	\$439	F1	4.6	22	11.15	112
1/6	1725	115	56CZ	NONE	H208	5KH32DN111	✓	\$145	F1	4.2	11	9.62	20
	1140/850	115	56CZ	NONE	H222	5KH49PN3047	✓	\$431	F1	4.2/2.9	43	11.70	20
	1140	115	56CZ	AUTO	H210	5KH37PN36X	✓	\$316	F1	4.0	19	11.08	20
	1140	115	56CZ	NONE	H209	5KH37PN36	✓	\$221	F1	4.0	19	11.08	20
1/4	1725	115	56CZ	NONE	H212	5KH33FN77	✓	\$154	F1	5.6	13	9.87	20
	1725	115	56CZ	AUTO	H213	5KH33FN77X	✓	\$231	F1	5.6	13	9.87	20
	1725/1140	115	56CZ	NONE	H223	5KH37PN40	✓	\$296	F1	4.2/2.7	20	11.08	20
	1140/850	115	56CZ	NONE	H224	5KH49SN3049	✓	\$525	F1	5.8/3.6	29	11.91	20
	1140	115	56CZ	NONE	H214	5KH46MN6071	✓	\$262	F1	5.6	22	11.15	20
	1140	115	56CZ	AUTO	H215	5KH46MN6071X	✓	\$361	F1	5.6	22	11.15	20
	850	115	56CZ	AUTO	H288	5KH49SN3023X	✓	\$617	F1	6.9	31	13.59	20
	1725	115	56CZ	NONE	H217	5KH35JN121	✓	\$174	F1	6.6	14	10.25	20
1/3	1725	115	56CZ	AUTO	H218	5KH35JN121X	✓	\$261	F1	6.6	14	10.25	20
	1725/1140	115	56CZ	NONE	H225	5KH46MN3040	✓	\$368	F1	5.7/3.2	22	11.15	20
	1140	115	56CZ	NONE	H219	5KH49PN6069	✓	\$432	F1	7.0	31	11.70	20
	850	115	56CZ	AUTO	H280	5KH49UN3024X	✓	\$647	F1	9.2	40	13.59	20
1/2	1725	115	56CZ	NONE	H290	5KH36MN137	✓	\$230	F1	7.2	16	11.31	19
	1725/1140	115	56CZ	AUTO	H282	5KH49PN3042X	✓	\$444	F1	8.0/4.2	31	11.70	19
	1725/1140	115	56CZ	NONE	H226	5KH49PN3042	✓	\$432	F1	8.0/4.2	26	11.70	19
	1140	115	56CZ	NONE	H221	5KH48UN6074	✓	\$490	F1	9.0	34	12.66	19
	1140	115/208-230	56C	NONE	G278	56C11D5304	✓	\$448	F1	10.6/5.1-5.3	32	11.94	2,19

# Furnace Blower, Split Phase

## Open, PDQ Mounting

### Applications:

Designed for replacement of virtually any NEMA 48 and 56 frame belt drive furnace blower motors. PDQ models have 1 1/2" extended splined hub on opposite shaft end for quick and easy positioning of resilient ring to properly fit the pre-existing motor base.

### Features:

- Ball bearings
- Reversible rotation connected for CCW rotation from factory
- NEMA service factors
- 4733, 4734 and 4735 have both 48 and 56 frame mounting holes and includes mounting base
- UL Recognized and CSA Certified



HP	RPM	VOLTS	FRAME	OVER LOAD	CAT. NO.	MODEL NO.	STOCK	LIST PRICE	MULT. SYMB.	F.L. AMPS	WEIGHT	"C" DIM.	MIN/MAX BASE DIM'S	FOOT NOTES
1/4	1725	115	48Y	AUTO	4733	5KH39DNA533T	✓	\$159	F1	5.1	13	9.78	6.62" & 7.91"	
	1725	115	48Y	AUTO	4730	5KH39QN9725T	✓	\$146	F1	5.0	13	9.78	6.62" & 7.91"	30
1/3	1725	115	48Y	AUTO	4734	5KH32HNA532T	✓	\$171	F1	6.6	15	10.03	6.87" & 8.16"	
	1725	115	48Y	AUTO	4731	5KH39QN9696X	✓	\$157	F1	5.8	15	10.28	7.12" & 8.41"	30
	1725	230	48Y	AUTO	4738	5KH39QN9703T	✓	\$256	F1	3.1	15	10.28	7.12" & 8.41"	30
1/2	1725	115	48Y	AUTO	4732	5KH39QN9702T	✓	\$207	F1	7.9	17	10.66	7.50" & 8.79"	30
	1725	115	48Y	AUTO	4735	5KH33JNA534T	✓	\$224	F1	7.9	15	10.28	6.62" & 7.91"	
	1725	230	48Y	AUTO	4739	5KH39QN9704T	✓	\$323	F1	4.0	17	10.66	7.50" & 8.79"	30

# Oil Burner, Split Phase and Capacitor Start NEMA 48M and 48N Flange Mount

### Applications:

Direct replacement motors for residential and commercial oil burners and hot water pressure/steam cleaners.



### Features:

- Ball Bearings (except as noted)
- Semi- or totally enclosed steel frame
- 20" Long leads from a 1/2" NPT opening (totally enclosed footnoted with N)
- Split phase and capacitor start designs
- Two-bolt, NEMA N- or M-Flange direct
- Catalog numbers 4781, 4788, O010 mounting and O011 have dripproof enclosures
- 1.0 Service Factor

HP	RPM	VOLTS	FRAME	OVER LOAD	CAT. NO.	MODEL NO.	STOCK	LIST PRICE	MULT. SYMB.	F.L. AMPS	WEIGHT	"C" DIM.	FOOT NOTES
1/8	3450	115	48N	MANUAL	O005	48S34S2004	✓	\$128	F1	2.4	9	7.09	3,61
	1725	115	48N	MANUAL	O600	48S17T286	✓	\$112	F1	2.8	11	7.7	CF,N,3
1/7	3450	115	48M	MANUAL	O100	48S34S361	✓	\$138	F1	2.8	11	7.7	CF,3
	1/6	3450	115	48M	MANUAL	O102	48S34S2005	✓	\$146	F1	3.0	11	7.25
1/5	1725	115	48N	MANUAL	O601	48S17T290	✓	\$120	F1	2.7	12	7.59	CF,N,3
	3450	115/230	48N	MANUAL	O012	48C34S24	✓	\$170	F1	3.0/1.5	14	8.35	2,61
1/4	3450	115	48N	MANUAL	O004	48S34S2003	✓	\$170	F1	4.2	13	8.13	CF,3
	3450	115/230	48N	MANUAL	O013	48C34S2001		\$177	F1	4.4/2.2	19	8.6	2
	1725	115	48N	MANUAL	O002	48S17S25	✓	\$145	F1	4.2	12	7.59	3
1/3	3450	115/230	48N	MANUAL	4788	5KC37EN3900U	✓	\$186	F1	6.0/3.0	14	10.13	d
	3450	115/208-230	48N	MANUAL	O010	48C34D2024	✓	\$186	F1	5.6/2.7-2.8	14	10.34	2
	3450	115	48N	MANUAL	4774	5KH33GN5014U	✓	\$173	F1	4.9	15	8.38	3,4
	1725	115	48N	MANUAL	O003	48S17S24	✓	\$168	F1	5.0	17	8.34	3
1/2	3450	115/230	48N	MANUAL	4781	5KC37HN3898U		\$229	F1	8.2/4.1	15	10.13	
	3450	115/208-230	48N	MANUAL	O011	48C34D2028	✓	\$229	F1	7.4/3.5-3.7	17	10.84	2

# Oil Burner, PSC NEMA 48M Flange Mount

### Applications:

Replacement motors for mini pumps in residential or light commercial furnaces.



### Features:

- High efficiency design
- 14" cord for easy connection
- Ultra quiet performance
- UL Recognized and CSA Certified

HP	RPM	VOLTS	FRAME	OVER LOAD	CAT. NO.	MODEL NO.	STOCK	LIST PRICE	MULT. SYMB.	F.L. AMPS	WEIGHT	"C" DIM.	FOOT NOTES
1/7	3450	115	48M	AUTO	O701	48A34SU1001	✓	\$119	F1	1.7	8	6.61	3,61

## Oil Burner, Split Phase and Capacitor Start Dripproof, NEMA 56C, C-Face Footless

### Features:

- Ball Bearings
- Manual or automatic reset thermal
- Split Phase and capacitor start designs protector
- NEMA 56C direct mounting
- NEMA Jet Pump Service Factors
- Moderate starting torque
- UL Recognized and CSA Certified



HP	RPM	VOLTS	FRAME	OVER LOAD	CAT. NO.	MODEL NO.	STOCK	LIST PRICE	MULT. SYMB.	F.L. AMPS	WEIGHT	"C" DIM.	FOOT NOTES
1/4	3600	115	56C	MAN	O200	56S34D2000	✓	\$139	F1	4.3	14	10.19	3,15,115
1/3	3600	115	56C	AUTO	O201	56S34D93	✓	\$132	F1	5.6	14	10.44	2,3,15
	3600	115/230	56C	AUTO	J1025	5KC37FN71X	✓	\$154	F1	6.4/3.2	14	10.71	2,115
	3600	115/208-230	56C	MAN	O211	56C34D2109	✓	\$161	F1	5.6/2.7-2.8	14	10.44	2,115
	3600	115/208-230	56C	AUTO	O210	56C34D2114	✓	\$154	F1	5.6/2.7-2.8	14	10.44	2,115
1/2	3600	115/208-230	56C	MAN	O213	56C34D2099	✓	\$176	F1	7.4/3.5-3.7	16	10.69	2,114
	3600	115/208-230	56C	AUTO	O212	56C34D2098	✓	\$169	F1	7.4/3.5-3.7	17	10.69	2,114
	3600	115/230	56C	AUTO	C330	5KC36JN268X	✓	\$205	F1	7.6/3.8	17	10.31	2,114
3/4	3600	115/208-230	56C	MAN	O215	56C34D2112	✓	\$199	F1	9.8/4.8-4.9	18	10.94	2,113
	3600	115/208-230	56C	AUTO	O214	56C34D2104	✓	\$199	F1	9.8/4.8-4.9	20	10.94	2,113
	3600	115/230	56C	AUTO	C332	5KC39NN50X	✓	\$199	F1	11.2/5.6	22	11.84	2,113
1	3600	115/230	56C	AUTO	C334	5KC39RN44X	✓	\$223	F1	13.2/6.6	22	12.59	2,112
	3600	115/208-230	56C	MAN	O217	56C34D2105	✓	\$230	F1	12.0/6.2-6.0	24	11.94	2,112
1 1/2	3600	115/208-230	56C	MAN	O231	56B34D2028	✓	\$312	F1	13.4/7.4-6.7	25	11.97	1,111
	3600	115/208-230	56C	AUTO	C336	5KC49NN2140X	✓	\$304	F1	18.4-9.8/9.2	27	11.38	1,111
2	3600	115/208-230	56C	AUTO	C338	5KC49TN2141X	✓	\$377	F1	21.2-11.5/10.6	38	13.22	1,110
	3600	115/208-230	56C	MAN	O232	56B34D5337	✓	\$386	F1	19.2/10.3-9.6	33	11.44	1,110
3	3600	115/230	56C	AUTO	C340	5KCR48TN2142T	✓	\$599	F1	29.4/14.7	38	12.66	1,18

## Oil Burner, Three Phase Dripproof, NEMA 56C, C-Face Footless

### Features:

- Double sealed ball bearings
- NEMA Jet Pump Service Factors
- NEMA 56C direct mounting
- Ball Bearings
- UL Recognized and CSA Certified



HP	RPM	VOLTS	FRAME	OVER LOAD	CAT. NO.	MODEL NO.	STOCK	LIST PRICE	MULT. SYMB.	F.L. AMPS	WEIGHT	"C" DIM.	FOOT NOTES
1/3	3600	208-230/460	56C	NONE	KG215	5K35FN55	✓	\$177	F1	1.5-1.8/0.9	14	9.88	68,115
1/2	3600	208-230/460	56C	NONE	K216	5K36JN57	✓	\$202	F1	2.0-2.0/1.0	15	10.31	68,114
3/4	3600	208-230/460	56C	NONE	K218	5K37MN37	✓	\$243	F1	2.6-2.6/1.3	17	10.7	68,113
1	3600	208-230/460	56C	NONE	K220	5K38PN47	✓	\$276	F1	3.3-3.2/1.6	20	11.3	68,112
1 1/2	3600	208-230/460	56C	NONE	K222	5K46KN2173	✓	\$336	F1	5.0-4.8/2.4	24	10.73	68,111
2	3600	208-230/460	56C	NONE	K224	5K49NN2180	✓	\$395	F1	6.0-6.0/3.0	27	11.33	68,110
3	3600	208-230/460	56C	NONE	K226	5K48TN2182	✓	\$473	F1	8.9-8.2/4.1	36	12.61	68,18

## Refrigeration Fan, PSC, Open Air Over Resilient Ring & Thru-Bolt Mount

**Features:**

- Open end bracket
- Ball Bearings
- Automatic reset thermal protector
- BX connector included in frame (except on Catalog # X262)
- Catalog # X263 and X264 have 12" cord and molded plug
- UL Recognized and CSA Certified
- Capacitor included (except on Catalog # X262 and X426)



HP	RPM	VOLTS	FRAME	CAT. NO.	MODEL NO.	STOCK	LIST PRICE	MULT. SYMB.	F.L. AMPS	WEIGHT	FRAME LENGTH	"C" DIM.	FOOT NOTES
1/6	1625	208-230	48Y	X269	48A17O147	✓	\$201	F1	1.2	11	5.00	1/2 x 1 1/2	1
1/4	1625	208-230	48Y	X270	48A17O149	✓	\$216	F1	1.9	12	5.69	1/2 x 2 1/2	1
	1075	208-230	48Y	X263	48A11O11041		\$173	F1	2.0	13	4.25	1/2 X 3 3/4	16
	1075	208-230	48Y	X262	48A11D245	✓	\$182	F1	1.8	15	7.25	1/2 x 1 5/8	67,69,82
1/3	1625	208-230	48YZ	X230	48A17O136	✓	\$181	F1	1.8	14	5.69	1/2 x 3 1/2	15
	1075	208-230	48YZ	X268	48A11O1239	✓	\$221	F1	3.0	14	5.69	1/2 x 2 1/2	15
3/4	1075	460	48YZ	X426	48A11O1375	✓	\$270	F1	2.2	19	6.38	5/8 X 4 1/2 w/key	67,69

## Refrigeration Fan Motors, Three Phase Open Air Over, Shaft Up & Horizontal Rigid Base Mount

**Applications:**

Replacement motor for refrigeration equipment.

**Features:**

- 70°C ambient
- Enclosed shaft end bracket, vented frame
- Continuous duty
- Automatic reset thermal protector
- Shaft slinger
- Threaded lead exit
- Nameplated 60/50 hertz 190/380 volts, at next lower HP
- Double sealed ball bearings
- Flat and keyway on shaft
- Patented VCD, Voltage Change Device
- Ball Bearings
- UL Recognized and CSA Certified



X507 (Footless)

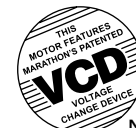

As Noted

HP	RPM	VOLTS	FRAME	CAT. NO.	MODEL NO.	STOCK	LIST PRICE	MULT. SYMB.	F.L. AMPS	WEIGHT	FRAME LENGTH	"C" DIM.	FOOT NOTES
1/2	850	208-230/460	56HZ	X529	56T8O5531	✓	\$547	F1	2.9-3.0/1.5	31	9.62	5/8 x 5	VC,5
1	850	208-230/460	56HZ	X528	56T8O5306	✓	\$614	F1	5.1-5.3/2.65	49	10.62	5/8 x 5	VC,5
	850	208-230/460	56Y	X507	56T8O5302	✓	\$597	F1	5.3-5.3/2.6	46	12.00	5/8 x 5	VC
	850	575	56Y	K1511	5K48WN3181S	✓	\$563	F1	2.0	44	10.77	5/8 X 6	
1 1/2	1140	208-230/460	56HZ	X523	56T11O5306	✓	\$501	F1	5.45-5.4/2.7	36	11.00	5/8 x 5	VC,5
	850	208-230/460	56HZ	X531	56T8O15504	✓	\$668	F1	7.0-7.0/3.5	47	11.50	5/8 x 5	VC,5
2	1140	208-230/460	56HZ	X525	56T11O5310	✓	\$543	F1	7.2-6.8/3.4	47	12.00	5/8 x 5	VC,54

# Transformer Cooling Fan Replacement

## TEAO, Single Speed, Rigid Base

### Features:

- External cooling air required
- Reversible rotation
- Ball Bearings
- Optional extended clamp screws
- Z shaft is .50 x 2.25" with 1.91" Flat



### Single Phase

HP	RPM	VOLTS	FRAME	CAT. NO.	MODEL NO.	STOCK	LIST PRICE	MULT. SYMB.	F.L. AMPS	WEIGHT	"C" DIM.	FOOT NOTES
1/20	1625	115/200-230	48Z	PG240	5KCP35CNA490S	✓	\$327	F1	1.5/07-0.8	12	10.32	9,25,50,94,113
1/3	1075	115/200-230	56Z	P241	5KCP36RNA491S	✓	\$413	F1	4.4/2.1-2.2	21	10.75	9,25,50,94,113

### Three Phase

HP	RPM	VOLTS	FRAME	CAT. NO.	MODEL NO.	STOCK	LIST PRICE	MULT. SYMB.	F.L. AMPS	WEIGHT	"C" DIM.	FOOT NOTES
1/3	1200	200-230/460	56	K1487	5K49MN6126T	✓	\$579	F1	2.1-2.0/1.0	27	10.38	68,113

# Unit Heater Fan, PSC, TEAO

## Resilient Base

### Applications:

Replacement motors for unit heaters. Air over motors need to be mounted within the airstream for proper cooling.



### Features:

- Totally enclosed
- Direct drive, air over
- Ball Bearings
- Horizontal or vertical mount
- Weather resistant reversing plug
- BX connector mounted in frame
- 1" Extended thru-bolts
- 48Y Frame has non-standard BA dimension
- Automatic reset thermal protection
- UL Recognized and CSA Certified
- Capacitor included

HP	RPM	VOLTS	FRAME	CAT. NO.	MODEL NO.	STOCK	LIST PRICE	MULT. SYMB.	F.L. AMPS	WEIGHT	FRAME LENGTH	"C" DIM.	FOOT NOTES
1/6	1625	115	48Y	X305	48A17T2001	✓	\$164	F1	2.0	13	4 3/4	1/2 x 2 3/4	
	1625	115	48Y	X301	48A17T72	✓	\$146	F1	2.0	13	5 1/4	1/2 x 2 3/4	
	1075	115	48Y	X302	48A11T199	✓	\$170	F1	3.0	13	4 3/4	1/2 x 2 3/4	
1/4	1075	115	48Y	X303	48A11T198	✓	\$178	F1	4.1	14	4 3/4	1/2 x 2 3/4	
1/3	1075	115	48Y	X304	48A11T201	✓	\$197	F1	6.5	21	21	1/2 x 2 3/4	

# Circulator Pump, Split Phase

## Dripproof, Resilient Ring

### Applications:

Direct replacements for Taco hot water circulators.

### Features:

- Quiet sleeve bearing construction
- 48Z frame with 1/2" diameter shaft, 1" long without flat
- 1.40 Service Factor (except as noted)
- Fixed CCW rotation, viewed opposite shaft end
- 4722 replaces Taco No. 110-388, Marathon No. 48S17D1027, 48S17D2102
- 4404 replaces GE No. 5KH32EG129GA, Marathon No. 48S17D1084
- UL Recognized and CSA Certified



HP	RPM	VOLTS	FRAME	CAT. NO.	MODEL NO.	STOCK	LIST PRICE	MULT. SYMB.	F.L. AMPS	WEIGHT	"C" DIM.	FOOT NOTES
1/12	1800	115	48Y	4722	5KH39QN5558T	✓	\$116	F1	2.1	12	7.29	
1/8	1800	115	48Y	4404	5KH39QN5550X	✓	\$126	F1	2.6	11	8.93	
1/4	1800	115	48Y	HG716	5KH36DNA780X		\$277	F1	5.7	12	9.01	4,17
1/3	1800	115	48Y	HG717	5KH37GNA782X		\$296	F1	6.2	14	9.41	4,17



# ME-CAN-DO Multi-Horsepower Motors

The new Marathon Motors "Me-Can-Do" line of motors is a Multi-horsepower motor that replaces many different ratings.

Here are some of the advantages of the ME-Can-Do motor:

1. Saves money! Eliminates unnecessary inventory on shelves or in repair trucks.
2. Saves time! No more long drives for replacement motors. No more late hour or emergency shop openings.
3. This motor "Can Do" the job the first time! Offers multiple options in just one motor, no need for temporary substitutions.

Here are some of the motors that the ME-Can-Do motors replaces today:

## Condenser Fan Motors

MARATHON	EMERSON	A.O. SMITH
X072	5462	FSE6000
X076	5465	FE6002

## Direct Drive Fan and Blower Motors

MARATHON	EMERSON	A.O. SMITH
X033	5460	FDL6001
X073	5461	FD6000
X074	5470	FDL6002
X075	5471	FD6001

# ME-CAN-DO Multi-Horsepower Condenser Fan, PSC, TEAO, Thru-Bolt

## Applications:

Direct drive fans for shaft up or horizontal mount. These motors need to be mounted within the airflow of the fan for proper cooling.

## Features:

- Ball Bearings
- 60°C ambient
- Automatic reset thermal protector
- Weather resistant reversing plug
- Reversible by reconnection
- 36" long leads
- Extended thru-bolts, 8-32 1/2" on drive end, 3/4" on non-drive end
- Shaft slinger
- Four Locating screws on frame, 90° apart
- 1/2" x 5" long shaft with two flats 4.50" 90° apart
- UL Recognized and CSA Certified
- Capacitor not included, see Accessories section



HP	RPM	VOLTS	FRAME	CAPACITOR (MFD)	SPEED RANGE	CAT. NO.	MODEL NO.	STOCK	LIST PRICE	MULT. SYMB.	WEIGHT	F.L. AMPS	FRAME LENGTH
1/3		230		5.0	HI							2.3	
1/3		208		7.5	HI							2.3	
1/4		230		5.0	HI							2.0	
1/4	1075/2	208	48Y	7.5	HI	X072	48A11T646	✓	\$191	F1	14	2.0	5 1/2
1/5		230		5.0	LO							1.4	
1/5		208		7.5	LO							1.4	
1/6		230		5.0	LO							1.2	
1/6		208		7.5	LO							1.2	
1/2		230		10.0	HI							2.5	
1/2		208		12.5	HI							2.6	
1/3		230		10.0	HI							2.1	
1/3	1075/2	208	48Y	12.5	HI	X076	48A11T11006	✓	\$205	F1	19	2.0	5 1/2
1/4		230		10.0	LO							1.4	
1/4		208		12.5	LO							1.4	
1/5		230		10.0	LO							1.2	
1/5		208		12.5	LO							1.2	

# ME-CAN-DO Multi-Horsepower Fan & Blower - Direct Drive, PSC, Open Air Over Resilient Ring, Thru-Bolt

## Applications:

Residential and commercial furnaces, air conditioners, exhaust fans, and other air handling equipment installed in clean and dry environments.

## Features:

- Open end brackets
- 2 1/4" Resilient rings
- 1/2" x 5" long shaft with two flats 4.50" 90O apart
- Automatic reset thermal protector
- Weather resistant reversing plug
- Reversible by reconnection
- 36" long leads
- Extended thru-bolts, 8-32 1/2" on drive end, 3/4" on non-drive end
- UL Recognized and CSA Certified
- Capacitor not included, see Accessories section
- Ball Bearings



HP	RPM	VOLTS	FRAME	CAPACITOR (MFD)	SPEED RANGE	CAT. NO.	MODEL NO.	STOCK	LIST PRICE	MULT. SYMB.	WEIGHT	F.L. AMPS	FRAME LENGTH
1/2				10.0	ALL							6.1	
1/3				5.0	ALL							5.2	
1/3				7.5	ALL							4.7	
1/4				5.0	MED-HI							3.6	
1/4	1075/4	115	48Y	7.5	MED-LO, LO	X077	48A11O11066	✓	\$145	F1	15	3.2	5
1/5				5.0	MED-LO							2.8	
1/5				7.5	LO							2.5	
1/6				5.0	LO							2.4	
1/6				7.5	LO							2.0	
1/2				10.0	ALL							2.7	
1/3				5.0	ALL							2.3	
1/3				7.5	ALL							2.1	
1/4				5.0	MED-HI							1.6	
1/4	1075/4	208-230	48Y	7.5	MED-LO, LO	X073	48A11O11064	✓	\$149	F1	14	1.4	4 3/4
1/5				5.0	MED-LO							1.3	
1/5				7.5	LO							1.1	
1/6				5.0	LO							1.1	
1/6				7.5	LO							0.9	
3/4				20.0	ALL							7.8	
1/2				10.0	ALL							7.1	
1/3	1075/4	115	48Y	10.0	MED-HI, MED-LO, LO	X074	48A11O11042	✓	\$173	F1	22	4.9	6
1/4				10.0	MED-LO, LO							3.7	
1/5				10.0	LO							2.9	
3/4				20.0	HI							3.8	
1/2				20.0	MED-HI							2.7	
1/2				10.0	HI							3.7	
1/3	1075/4	208-230	48Y	20.0	MED-LO	X075	48A11O11063	✓	\$185	F1	22	1.9	6
1/3				10.0	MED-HI							2.8	
1/4				20.0	LO							1.4	
1/4				10.0	MED-LO							2.6	
1/5				10.0	LO							1.6	

## OEM: Carrier

### PSC, Open Air Over

Features:

- Ball Bearings
- Multi-speed capability, as noted
- Resilient ring/belly band mount
- X236 Replaces Carrier Nos. HC41SE117, P251-2306 & -2307
- X237 Replaces Carrier Nos. HC41SE651, HC39SE651, P251-5306, & P251-5408
- X203 Replaces Carrier No. HC44AL230, Fasco No. D804, & Magnetek No. 655
- X241 Replaces Carrier Nos. HC45SE651 & P251-5701
- X242 Replaces Carrier Nos. HC52AL230, 231, & 232 HC52SE208, P251-5101 & -5102
- Capacitor not included, see Accessories section



HP	RPM	VOLTS	FRAME	CAT. NO.	MODEL NO.	STOCK	LIST PRICE	MULT. SYMB.	F.L. AMPS	WEIGHT	FRAME LENGTH	SHAFT DIM.	FOOT NOTES
1/3	1075/4	115	48Y	X236	48A11O699	✓	\$173	F1	6.4	16	4 3/4	1/2x6	
	1075/4	208-230	48Y	X237	48A11O694		\$176	F1	4.8	16	5 1/4	1/2x6	
1/2	1075	208-230	48Y	X203	48A11O1062	✓	\$216	F1	5.3	19	6 1/2	1/2 x 5 1/2	16
3/4	1075/4	208-230	48Y	X241	48A11O697	✓	\$223	F1	5.4	17	5 1/2	1/2x6	
1	1000/3	208-230	48YZ	X242	48A11O756	✓	\$377	F1	6.2	26	7 1/4	5/8x4	51,68

Replacements listed may not be an exact duplicate of the original motor

## OEM: Carrier

### PSC, Open Air Over

Features:

- Single and multi-speed models, as noted
- 3 lug mounting
- X223 Replaces Carrier No. HC37VE230 & Fasco No. D842
- X273 Replaces Carrier No. HC37ME268, Fasco No. D844, A.O. Smith No. OCA1024, & Magnetek No. 624
- X210 Replaces Carrier Nos. HC37MZ220, HC39VE608, HC39ML706, HC37ME720, HC37ML702
- X210 Replaces Emerson No. 3303, Fasco No. D843, Magnetek No. 514, & A.O. Smith No. OCB1026
- X222 Replaces Carrier Nos. HC41VE700 & 701, Emerson No. 3225, Magnetek No. 536, & A.O. Smith No. OCB1036
- X294 Replaces Carrier No. HC43CE230
- X405 Replaces A.O. Smith No. OCA1056
- Ball bearings (except as noted)
- Capacitor not included, see Accessories section

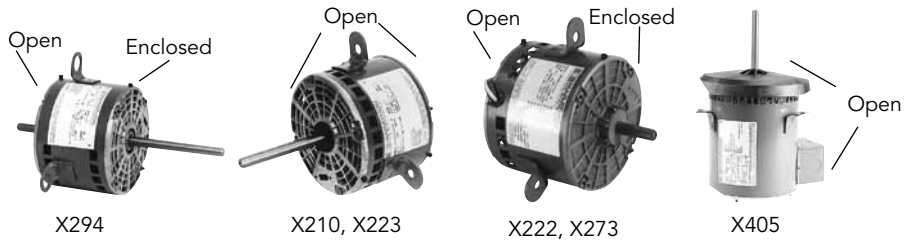

HP	RPM	VOLTS	FRAME	CAT. NO.	MODEL NO.	STOCK	LIST PRICE	MULT. SYMB.	F.L. AMPS	WEIGHT	FRAME LENGTH	SHAFT DIM.	FOOT NOTES
1/5	1075/1	230	48Y	X223	48A11O2050		\$146	F1	1.3	10	3 3/4	1/2 x 2 3/4	16
1/4	1625/1	230	48Y	X273	48A17O161		\$137	F1	1.5	12	4 1/4	1/2 x 1 5/8	16
	1075/2	208-230	48Y	X210	48A11O1068	✓	\$146	F1	2.2	13	4 1/8	1/2 x 4 1/4	
1/3	1075/2	230	48Y	X222	48A11O1109	✓	\$182	F1	2.6	15	4 3/4	1/2 x 3	
1/2	1075/1	208-230/460	48Y	X405	48A11O1744	✓	\$237	F1	3.6/1.8	25	6 7/8	1/2 x 4	21

## OEM: Carrier

### Three Phase, Open Air Over

Features:

- Ball Bearings
- X235 is 70°C ambient
- Ball Bearings
- X235 replaces Carrier No. HD52VE214 & Marathon No. 56T11D33
- X251 replaces Carrier No. HD60AZ660 & Marathon No. 56T34D903



X235



X251

HP	RPM	VOLTS	FRAME	CAT. NO.	MODEL NO.	STOCK	LIST PRICE	MULT. SYMB.	F.L. AMPS	WEIGHT	FRAME LENGTH	SHAFT DIM.	FOOT NOTES
1	1140	200-230/460	56Y	X235	56T11D5209	√	\$469	F1	6.6-6.0/3.0	36	10 1/2	5/8 x 2 7/8	
5	3600	208-230/460	56HZ	X251	56T34D5364	√	\$654	F1	13.5-12.4/6.2	50	13.49	7/8 x 2 1/4	Z,5

Replacements listed may not be an exact duplicate of the original motor

## OEM: Evans/Armstrong/LSI Home

### PSC, Open Air Over

Features:

- Resilient ring thru-bolt mounting
- Replaces Fasco No. D825 & GE No. 5KCP35G644S
- Ball bearings
- Capacitor not included, see Accessories section

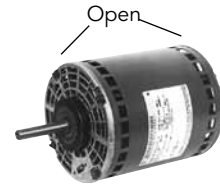

HP	RPM	VOLTS	FRAME	CAT. NO.	MODEL NO.	STOCK	LIST PRICE	MULT. SYMB.	F.L. AMPS	WEIGHT	FRAME LENGTH	FOOT NOTES
1	1625/2	208-230	48Y	X211	48A17O125	√	\$248	F1	6.2	20	6 1/4	1/2 x 2 1/2

## OEM: Greenheck Fan

### PSC, Open Air Over

Features:

- Thru-bolt mounting
- Automatic reset thermal protector
- Internal cooling fan
- X261 replaces Greenheck No. 300008
- X260 replaces Greenheck No. 300010
- Ball bearings
- Capacitor included



HP	RPM	VOLTS	FRAME	CAT. NO.	MODEL NO.	STOCK	LIST PRICE	MULT. SYMB.	F.L. AMPS	WEIGHT	FRAME LENGTH	FOOT NOTES
1/8	825	115	48Y	X261	48A8O151	√	\$195	F1	2.1	13	5 1/2	1/2 X 2 1/2
1/6	1140	115	48Y	X260	48A11O251	√	\$185	F1	2.2	13	5 1/4	1/2 X 2 1/2

Replacements listed may not be an exact duplicate of the original motor

## OEM: Hill Refrigeration

### PSC, Open Air Over

Features:

- Resilient base
- Replaces Magnetek No. 160, Stevco No. S3001, Fasco No., D801, GE No. 5KCP39KG1369S
- Ball bearings
- Capacitor included

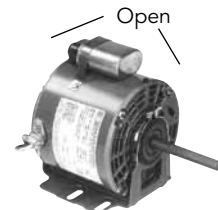

HP	RPM	VOLTS	FRAME	CAT. NO.	MODEL NO.	STOCK	LIST PRICE	MULT. SYMB.	F.L. AMPS	WEIGHT	FRAME LENGTH	SHAFT DIM.	FOOT NOTES
1/3	1625	208-230	48Y	X230	48A17O136	√	\$181	F1	1.8	14	4 3/4	1/2x3 1/2	15

## OEM: Huebsch

### Single Phase, Dripproof, Resilient Base



Applications:  
Commercial laundry dryer motors.

Features:

- Replaces Huebsch commercial laundry dryer motors
- Automatic reset thermal protection
- Special threaded shaft extension
- X602 has 3/4" shaft adapter included
- Ball bearings
- 48YZ have 48/56 Fr. mounting holes

HP	RPM	VOLTS	FRAME	CAT. NO.	MODEL NO.	STOCK	LIST PRICE	MULT. SYMB.	F.L. AMPS	WEIGHT	"C" DIM.	FOOT NOTES
1/4	1725	100-120/200-240	48YZ	X600	48C17D2057		\$239	F1	5.4-6.6/2.7-3.3	18	12.02	16,68
1/3	1725	115/208-230	56Z	X601	56C17D2101	√	\$283	F1	5.8/2.8-2.9	20	14.41	16
1/2	1725	115/208-230	56Z	X602	56C17D2102	√	\$348	F1	8.0/4.0-4.0	24	15.41	16
3/4	1725	115/208-230	56Z	X603	56C17D5346	√	\$439	F1	12.0/5.8-6.0	29	15.10	16

## OEM: Hussman Refrigeration

### PSC, Open Air Over

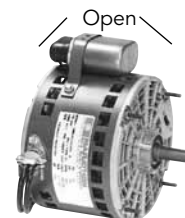

Features:

- Thru-bolt mounting
- Replaces Fasco No. D807, GE No. 5KCP39EGC2447, Magnetek No. 174, Emerson No. 1645
- Ball bearings
- Capacitor included

HP	RPM	VOLTS	FRAME	CAT. NO.	MODEL NO.	STOCK	LIST PRICE	MULT. SYMB.	F.L. AMPS	WEIGHT	FRAME LENGTH	SHAFT DIM.	FOOT NOTES
1/6	1625	208-230	48Y	X269	48A17O147	√	\$201	F1	1.2	11	4 1/8	1/2 x 1 1/2	15

## OEM: Liebert

### Three Phase, Resilient Base

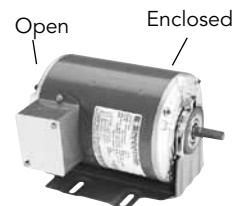

Features:

- Replaces GE 5K36PN294S
- Ball bearings

HP	RPM	VOLTS	FRAME	CAT. NO.	MODEL NO.	STOCK	LIST PRICE	MULT. SYMB.	F.L. AMPS	WEIGHT	FRAME LENGTH	SHAFT DIM.	FOOT NOTES
1/3	1140	208-230/460	48Y	X259	56T11O15	√	\$249	F1	1.9-1.8/9	29	10.06	1/2x1 1/2	15

Replacements listed may not be an exact duplicate of the original motor

# OEM: Lennox

## PSC, Totally Enclosed & Open Air Over

### Features:

- X411 replaces Lennox No. 47F9901, Magnetek No. 9402, & Marathon Nos. 48A11T300 & 48A11T247
- X209 replaces Fasco No. D2817 & GE No. 5KCP39PG9701S, open/air over
- X236 replaces Lennox No. P-8-7505, Magnetek No. 565, A.O. Smith No. OLE1036, & Fasco No. D812, open/air over
- X281 replaces Lennox No. P-8-2702, Fasco No. D814, GE No. 5KCP39GGA124S, & Emerson No. 8054, open/air over
- Ball Bearings
- Capacitor not included, see Accessories section

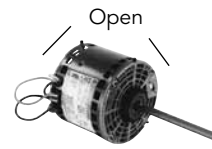
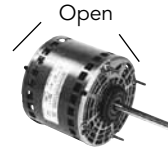
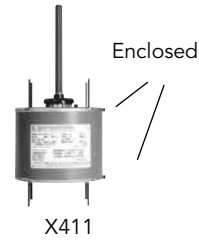

X209

X236, X281

OEM REPLACEMENTS

HP	RPM	VOLTS	FRAME	CAT. NO.	MODEL NO.	STOCK	LIST PRICE	MULT. SYMB.	F.L. AMPS	WEIGHT	FRAME LENGTH	SHAFT DIM.	FOOT NOTES
1/6	1075/1	208-230	48Y	X411	48A11T2008	✓	\$152	F1	1.3	10	3 3/4	1/2 x 6	
1/3	825/1	230	48Y	X209	48A8O183	✓	\$190	F1	3.0	17	5 3/4	1/2 x 5 1/2	34,50
	1075/4	115	48Y	X236	48A11O699	✓	\$173	F1	6.4	16	4 3/4	1/2 x 6	39

# OEM: Rheem / Ruud

## PSC, Totally Enclosed & Open Air Over

### Features:

- X278 Replaces Rheem Nos. 21276-02, 21276-01, 51207-01 & Fasco No. D832
- X216 Replaces Emerson No. 5454 & Magnetek No. 619
- X470 Replaces Rheem / Ruud condenser fans
- X297 Replaces A.O. Smith No. ORM1036, Magnetek 620, & Fasco No. D2834
- X033 Replaces Rheem Time-Savers, Emerson No. K55HXMDA-4122, & Rheem / Ruud No. 51-23012-41
- Ball Bearings
- Capacitor not included, see Accessories section

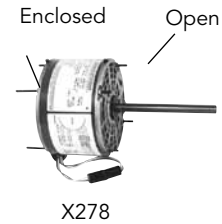

X278

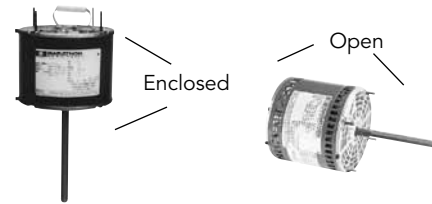

X297

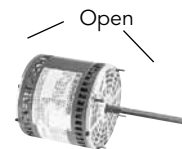

X033

HP	RPM	VOLTS	FRAME	CAT. NO.	MODEL NO.	STOCK	LIST PRICE	MULT. SYMB.	F.L. AMPS	WEIGHT	FRAME LENGTH	SHAFT DIM.	FOOT NOTES
1/8	825/1	208-230	48Y	X278	48A8O206	✓	\$181	F1	.9	11	4 1/4	1/2 x 4 3/4	37,44
1/5	1075/1	208-230	48Y	X216	48A11O1097	✓	\$133	F1	1.6	10	3 3/4	1/2 x 6	37,44,60
1/4	1075/1	208-230	48Y	X470	48A11O885	✓	\$140	F1	1.6	9	3 3/4	1/2 x 3	56,60
1/3	1075/1	208-230	48Y	X297	48A11T509	✓	\$141	F1	1.8	12	4 1/4	1/2 x 3 3/4	N,29,41,60
1/2	1075/4	115	48Y	X033	48A11O1674	✓	\$145	F1	6.1	16	5	1/2 x 5	31

Replacements listed may not be an exact duplicate of the original motor

# OEM: Sears/Whirlpool

## PSC, Open Air Over

### Features:

- X215 replaces Delco inside out window a/c, Fasco No. D857, A.O. Smith No. OWL1006, & Emerson No. 1142
- X212 replaces Delco inside out window a/c, Fasco No. D858, & A.O. Smith No. OWR1016
- X200 replaces Delco inside out window a/c, Fasco No. D859, Emerson No. 855, & A.O. Smith No. OWR1036
- X218 replaces Steveco Package unit 3100
- Single Split Phase, Open Air Over
- Capacitor not included, see Accessories section

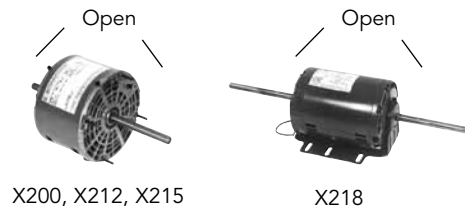

HP	RPM	VOLTS	FRAME	CAT. NO.	MODEL NO.	STOCK	LIST PRICE	MULT. SYMB.	F.L. AMPS	WEIGHT	FRAME LENGTH	SHAFT DIM.	FOOT NOTES
1/8	1100/3	115	48Y	X215	48A11O1081		\$145	F1	1.7	10	3 7/8	4 x 1/2 x 2 3/4	4,16
1/6	1100/3	230	48Y	X212	48A11O1065		\$145	F1	1.1	11	3 7/8	4 x 1/2 x 2 3/4	16
1/3	1100/3	230	48Y	X200	48A11O1060		\$147	F1	1.7	12	4 1/3	6 x 1/2 x 4	4,16
3/4	1075/1	208-230	56Z	X218	56A11O5313	√	\$385	F1	3.9-3.6	34	8 5/8	7 x 5/8 x 7	16,21

# OEM: Taco

## Single Split Phase, Open Air Over

### Features:

- Resilient ring mounting
- 4722 replaces Taco No. 110-388, Marathon No. 48S17D1027, 48S17D2102
- 4404 replaces GE No. 5KH32EG129GA, Marathon No. 48S17D1084
- UL Recognized and CSA Certified

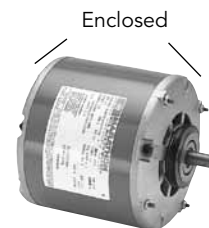

HP	RPM	VOLTS	FRAME	CAT. NO.	MODEL NO.	STOCK	LIST PRICE	MULT. SYMB.	F.L. AMPS	WEIGHT	FRAME LENGTH	SHAFT DIM.	FOOT NOTES
1/12	1800	115	48Y	4722	5KH39QN5558T	√	\$116	F1	2.1	12	7.29	1/2 x 1	
1/8	1800	115	48Y	4404	5KH39QN5550X	√	\$126	F1	2.6	11	8.93	1/2 x 1 1/2	

# OEM: Tyler

## PSC, Open Air Over

### Features:

- Resilient ring thru-bolt mounting
- Replaces Tyler No. 760, Fasco No. D870, & A.O. Smith No. OTY1024
- Ball bearings
- Capacitor included

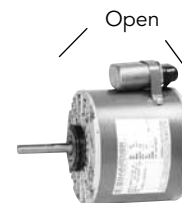

HP	RPM	VOLTS	FRAME	CAT. NO.	MODEL NO.	STOCK	LIST PRICE	MULT. SYMB.	F.L. AMPS	WEIGHT	FRAME LENGTH	SHAFT DIM.	FOOT NOTES
1/4	1625/1	208-230	48Y	X270	48A17O149	√	\$216	F1	1.9	12	4 3/4	1/2 x 2 1/2	16

Replacements listed may not be an exact duplicate of the original motor

## OEM: Warren PSC, Open Air Over

Features:

- Resilient ring mounting
- Ball bearings
- Capacitor included

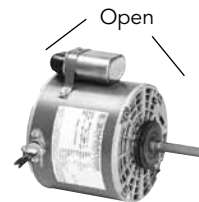

HP	RPM	VOLTS	FRAME	CAT. NO.	MODEL NO.	STOCK	LIST PRICE	MULT. SYMB.	F.L. AMPS	WEIGHT	FRAME LENGTH	SHAFT DIM.	FOOT NOTES
1/3	1075/1	208-230	48Y	X268	48A11O1239	✓	\$221	F1	3.0	14	4 3/4	1/2 x 2 7/8	15

OEM REPLACEMENTS

## OEM: York PSC, Open Air Over

Features:

- Round belly band mounting
- Replaces York No. K44HXJAF-4955 & Fasco No. D873, A.O. Smith No. OYK1056, Magnetek No. 468
- Ball bearings
- Capacitor not included, see Accessories section

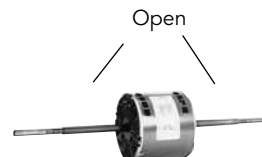

HP	RPM	VOLTS	FRAME	CAT. NO.	MODEL NO.	STOCK	LIST PRICE	MULT. SYMB.	F.L. AMPS	WEIGHT	FRAME LENGTH	SHAFT DIM.	FOOT NOTES
1/2	1050	230	48Y	X295	48A11O1410	✓	\$197	F1	3.9	19	5	9 1/4x1/2x9 1/8	15

## Pedestal Fan, PSC, TEAO 48 Frame, Yoke Mount

Features:

- Heavy gauge steel frame and yoke fan shroud mounted by four 7/8" extended stud bolts on 5-1/8" bolt circle
- Single and multi-speed models as noted
- Automatic reset thermal protector
- 1/2" x 2-1/2" long shaft with two flats, 90° apart
- 1.0 Service Factor
- Ball bearings (except as noted)
- Capacitor included
- UL Recognized and CSA Certified



HP	RPM	VOLTS	FRAME	CAT. NO.	MODEL NO.	STOCK	LIST PRICE	MULT. SYMB.	F.L. AMPS	WEIGHT	FRAME LENGTH	SHAFT DIM.	FOOT NOTES
1/4	1625/1	115/230	48Y	X920	48A17T2005	✓	\$203	F1	3.6/1.8	22	7.3	10.56	17
	1075/2	115	48Y	X923	48A11T2024	✓	\$237	F1	3.2	18	6.5	9.81	17
1/3	1625/1	115/230	48Y	X921	48A17T2006	✓	\$221	F1	3.8/1.9	24	7.8	11.06	17
	1075/2	115	48Y	X924	48A11T2025	✓	\$256	F1	4.2	19	6.5	9.81	17
1/2	1625/1	115/230	48Y	X922	48A17T2007	✓	\$244	F1	5.4/2.7	27	8.0	11.31	17
	1075/2	115	48Y	X925	48A11T2026	✓	\$285	F1	5.7	25	7.5	10.81	17

Replacements listed may not be an exact duplicate of the original motor



# Air Compressor, Single Phase

## Dripproof, Rigid Base

### Features:

- Capacitor start / capacitor run design for low amps and high efficiency, as noted
- High starting and breakdown torque
- Heavy gauge steel frame and base
- Continuous duty at nameplate ratings
- Thermal protection, as noted
- UL Recognized and CSA Certified



HP	RPM	VOLTS	FRAME	OVER LOAD	CAT. NO.	MODEL NO.	STOCK	LIST PRICE	MULT. SYMB.	F.L. AMPS	WEIGHT	"C" DIM.	FOOT NOTES
1/2	3600	115	56	MANUAL	9031	5KC49MN2043Y	✓	\$215	F1	11.5	20	11.14	2,17
	1800	115/208-230	56	MANUAL	C169	5KC49GN0010Y	✓	\$284	F1	8.8/4.4	21	10.38	2
3/4	3600	115	56	MANUAL	9032	5KC49MN2049Y	✓	\$250	F1	12.5	27	11.14	2,17
	1800	115/208-230	56	MANUAL	K016	56B17D56	✓	\$348	F1	11.0/5.5	25	11.47	1
1	3600	115/230	56	MANUAL	9033	5KC49NN2050Y	✓	\$285	F1	16.0/8.0	23	11.14	d,2,17
	3600	115/208-230	56	MANUAL	D010	56B34D2029	✓	\$287	F1	10.6/5.5-5.3	23	11.72	1
	1800	115/208-230	56	MANUAL	C1480	5KC49PN0161U	✓	\$379	F1	13.6/6.8	31	11.38	2
1 1/2	3600	115/208-230	56	MANUAL	C704	5KC49PN2521Y	✓	\$369	F1	21.3/10.6	31	11.91	2
	1800	115/208-230	56H	MANUAL	G951	56C17D5308	✓	\$443	F1	18.0/9.3-9.0	39	12.44	2,5,7
2	3600	115/208-230	56H	MANUAL	9035	5KCR48TN2650Y	✓	\$464	F1	15.0/7.5	38	11.14	ES,1,17
	1800	115/208-230	145T	MANUAL	I127	145TBDR5337	✓	\$534	S1	18.8/10.2-9.4	48	13.49	1,7
3	3600	230	56H	MANUAL	9036	5KCR48UN2653Y	✓	\$602	F1	15.0	40	11.44	ES,1,17
	1800	230	184T	NONE	Z502	184TBDR5326	✓	\$559	S1	12.6	51	14.27	1
SPCL	3600	230	56	MANUAL	9040	5KCR48UN2654Y	✓	\$542	F1	15.0	40	12.1	ES,1
5	3600	230	56H	MANUAL	9038	5KCR49ZN2722Y	✓	\$644	F1	21.0	49	15.04	ES,1,5,17
	3600	230	56H	MANUAL	D017	56B34D5302	✓	\$640	F1	20.0	55	13.94	1,5
	1800	208-230	184T	MANUAL	I119	184TBDR7375		\$891	S1	25.0-24.1	83	16.22	1
	1800	208-230	184T	NONE	I114A	184TBDW7026	✓	\$686	S1	23.0-21.0	82	14.69	1,13
	1800	208-230	184T	NONE	Z506A	184TBDW7656		\$672	S1	22.0-20.0	81	15.21	1,13
7 1/2	3600	208-230	184T	NONE	I108A	184TBDW7001	✓	\$770	S1	34.3-31.0	103	16.69	1,13
	3600	208-230	213T	NONE	I105	213TCDW7001	✓	\$1,047	S1	40.0-37.0	102	16.55	2
	1800	208-230	215T	NONE	I115	215TBDW7026	✓	\$1,027	S1	37.2-34.5	115	18.05	1
10	1800	208-230	215T	NONE	I116	215TBDW7028	✓	\$1,322	S1	49.0-44.0	140	19.3	1

DEFINITE PURPOSE

# Cooling Tower: Two-Speed-One Winding, Variable Torque Blue Chip® Severe Duty, XRI®

Three Phase, Totally Enclosed, Rigid Base

## Applications:

Cooling towers, Fan and Blowers, and other severe duty environments where long life and ultra-high efficiency are desired. Guaranteed efficiencies offer an eXtra Return on your Investment when using these premium efficiency motors on high cycle or long run applications. Replacement for two-speed Marley cooling tower motors.

## Features:

- Blue Chip® quality, 100% cast iron construction for rigidity and reduced vibration
- Internal and external epoxy paint
- Class F insulation
- 1.15 Service Factor
- Extended grease tubes, regreasable in service
- T-drains provided for effective drainage (Installed in both endshields)
- Shaft Slinger
- Forsheda seals on both ends
- Actual test and vibration data supplied with each motor
- Ball Bearings
- UL Recognized and CSA Certified
- Three year warranty
- Horizontal mounting only; consult Engineering for Vertical mounting



**IP55**

HP	RPM	VOLTS	FRAME	CAT. NO.	MODEL NO.	STOCK	LIST PRICE	MULT. SYMB.	NOM. EFF.	F.L. AMPS	WEIGHT	"C" DIM.	FOOT NOTES
3/7.5	1800/900	460	184T	Y380	184TTFS7290		\$1,384	S3	85.5	4.0/1.75	141	16.19	2,17
5/1.25	1800/900	460	213T	Y381	213TTFS7238		\$1,530	S3	89.5	6.0/2.4	199	19.72	
7.5/1.9	1800/900	460	215T	Y382	215TTFS7290	✓	\$1,983	S3	89.5	9.0/3.1	142	19.72	
10/2.5	1800/900	460	254T	Y383	254TTFNA7210		\$2,390	S3	90.2	12.0/4.0	360	23.52	
15/3.75	1800/900	460	256T	Y384	256TTFNA7250	✓	\$2,985	S3	90.2	18.0/6.0	381	25.27	
20/5	1800/900	460	284T	Y385	284TTFNA7240	✓	\$3,725	S3	91.7	24.0/8.5	489	26.34	
25/6.25	1800/900	460	286T	Y386	286TTFNA7260	✓	\$4,347	S3	91.7	31.0/11.0	168	27.84	
30/7.5	1800/900	460	324T	Y387	324TTFS7290	✓	\$5,305	S3	91.0	35.0/11.2	668	28.87	
40/10	1800/900	460	326T	Y388	326TTFS9210	✓	\$6,630	S3	87.5	46.0/14.6	451	30.37	
50/13	1800/900	460	364T	Y389	364TTFS9234	✓	\$8,432	S3	92.4	61.0/24.0	958	31.50	
60/15	1800/900	460	365T	Y390	365TTFS9230	✓	\$12,204	S3	92.4	75.0/25.0	1000	32.50	
75/18.75	1800/900	460	405T	Y391	405TTFS7297		\$15,786	S3	94.1	83.0/27.0	1331	37.12	1
100/25	1800/900	460	444T	Y392	444TTFS7262		\$19,093	S3	94.1	113/37.5	1781	41.25	

Blue shaded areas are Cast Iron Frames

# Multi-Speed: Two-Speed, One-Winding, Variable Torque

## Three Phase, Dripproof, Rigid Base

### Applications:

Commercial and industrial fans, blowers, pumps, and other machinery that have variable torque characteristics. Prolonged use at low speed can result in significant energy savings. Dripproof motors are intended for use in environments that are relatively clean and dry. For use outdoors an enclosure or drip cover may be required (see Accessories section).



### Features:

- Ball Bearings
- 1.15 Service Factor
- UL Recognized and CSA Certified

HP	RPM	VOLTS	FRAME	CAT. NO.	MODEL NO.	STOCK	LIST PRICE	MULT. SYMB.	NOM. EFF.	F.L. AMPS	WEIGHT	"C" DIM.	FOOT NOTES
3/7.5	1800/900	200-230	182T	Y1484	182TTDW7412	✓	\$651	S3	82.7	8.8-3.8/8.0-3.6	65	14.19	F,13
	1800/900	460	182T	Y485A	182TTDW7203		\$651	S3	82.7	4.0/1.8	58	13.19	13,25
5/1.25	1800/900	200-230	184T	Y486A	184TTDW7287	✓	\$912	S3	85.5	14.5-13.8/5.6-6	40	14.19	F,13
	1800/900	460	184T	Y1487	184TTDW7209	✓	\$912	S3	85.5	6.9/3.0	80	14.72	13
7.5/1.88	1800/900	200-230	213T	Y488	213TTDW7202		\$1,131	S3	86.5	21.6-19.8/7.6-7.8	110	17.30	
	1800/900	460	213T	Y489	213TTDW7201	✓	\$1,131	S3	87.5	9.6/3.6	118	17.30	
10/2.5	1800/900	200-230	215T	Y490	215TTDW17206		\$1,429	S3	86.5	29.0-26.4/10.0-10.0	87	18.55	F,13
	1800/900	460	215T	Y491	215TTDW7201		\$1,429	S3	86.5	12.5/4.5	106	17.30	
15/3.75	1800/900	460	256T	Y492	256TTDX7207		\$1,876	S3	87.5	18.4/6.1	197	22.32	
20/5	1800/900	460	284T	Y493	284TTP7202		\$2,335	S3	87.5	25.0/8.0	320	23.49	

Blue shaded areas are Cast Iron Frames

# Multi-Speed: Two-Speed, Two-Winding, Variable Torque

Additional Features: • Economical two-winding design

HP	RPM	VOLTS	FRAME	CAT. NO.	MODEL NO.	STOCK	LIST PRICE	MULT. SYMB.	NOM. EFF.	F.L. AMPS	WEIGHT	"C" DIM.	FOOT NOTES
1/25	1800/900	460	145T	Y465	145TTDR5701	✓	\$785	S3	79.5	1.5/0.75	42	12.99	5,13
1/44	1800/1200	200-230	145T	Y449	145TTDR5703	✓	\$785	S3	80.0	3.4-3.2/2.0-2.0	42	12.99	5,13
	1800/1200	460	145T	Y450	145TTDR5704		\$785	S3	78.5	1.5/1.0	39	12.49	5,13
1.5/3.7	1800/900	460	145T	Y466	145TTDR5702	✓	\$861	S3	78.5	2.2/1.1	47	13.49	5,13
1.5/6.7	1800/1200	200-230	145T	Y451	145TTDR5705	✓	\$861	S3	80.0	5.0-4.8/2.6-2.9	47	13.49	5,13
	1800/1200	460	145T	Y452	145TTDR5706	✓	\$861	S3	78.5	2.3/1.3	42	12.99	5,13
2/5	1800/900	460	182T	Y467A	182TTDW7411	✓	\$949	S3	82.0	2.8/2.15	68	13.19	13
2/8.8	1800/1200	200-230	182T	Y1453	182TTDW7413	✓	\$949	S3	76.4	6.6-6.5/3.8-4	60	12.69	13
2/9	1800/1200	460	182T	Y409A	182TTDW7211	✓	\$949	S3	76.4	3.3/2.0	60	12.69	13
3/7.5	1800/900	460	184T	Y468A	184TTDW7230	✓	\$988	S3	82.5	4/2.75	68	13.72	13
3/1.3	1800/1200	200-230	184T	Y454A	184TTDW7286	✓	\$988	S3	82.0	9.0-8.6/4.6-5	74	13.69	13
	1800/1200	460	184T	Y412A	184TTDW7215	✓	\$988	S3	82.0	4.3/2.5	74	13.69	13
5/1.25	1800/900	460	215T	Y469	215TTDW7205	✓	\$1,382	S3	86.5	6.8/3.1	118	17.30	
5/2.22	1800/1200	200-230	215T	Y455	215TTDW7204	✓	\$1,382	S3	85.5	14.5-13.0/7.3-7.0	116	17.30	
	1800/1200	460	215T	Y415	215TTDW7203	✓	\$1,382	S3	85.5	6.5/3.5	106	17.30	
7.5/1.9	1800/900	460	254T	Y470	254TTDX7201		\$1,715	S3	85.5	10.5/4.1	135	20.57	
7.5/3.3	1800/1200	200-230	254T	Y456	254TTDX7278	✓	\$1,715	S3	87.5	20.8-18.4/11.0-10.2	175	22.32	
	1800/1200	460	254T	Y418	254TTDX7208	✓	\$1,715	S3	84.0	10.0/5.6	154	20.57	
10/2.5	1800/900	460	256T	Y471	256TTDX7253		\$2,126	S3	86.5	12.9/5.6	145	22.32	
10/4.4	1800/1200	200-230	256T	Y457	256TTDX7263		\$2,126	S3	88.5	28.0-26.0/15.0-14.0	214	22.32	
	1800/1200	460	256T	Y458	256TTDX7264	✓	\$2,126	S3	87.5	12.0/6.5	214	22.32	
15/3.8	1800/900	460	284T	Y472	284TTP7205		\$2,844	S3	88.5	18.0/6.5	300	23.49	
15/6.7	1800/1200	460	284T	Y459	284TTP7221	✓	\$2,844	S3	87.5	18.5/9.5	325	23.49	
20/5	1800/900	460	286T	Y473	286TTP7251	✓	\$3,543	S3	88.5	25.0/8.5	321	24.99	d
20/8.9	1800/1200	460	286T	Y460	286TTP7217	✓	\$3,543	S3	88.5	25.0/12.0	326	24.99	

Blue shaded areas are Cast Iron Frames

DEFINITE PURPOSE

# Instant Reversing

## Single Phase

Features:

- Thermal protection, as noted
- Electronic instant reverse switch
- Extended clamp screws for mounting belt guard or accessories
- Three pole, double throw reversing switch supplied by customer



## Capacitor Start, Dripproof

HP	RPM	VOLTS	FRAME	OVER LOAD	CAT. NO.	MODEL NO.	STOCK	LIST PRICE	MULT. SYMB.	F.L. AMPS	WEIGHT	"C" DIM.	FOOT NOTES
1/4	1800	115	48	NONE	CG382	5KC35GNA488	✓	\$301	F1	5.2	14	9.57	20
1/3	1800	115	56	MANUAL	CG384	5KC35JNA489Y	✓	\$371	F1	6.3	16	9.89	20
	1800	115	56	NONE	CG383	5KC35JNA489	✓	\$366	F1	6.3	15	9.89	20
1/2	1800	115/230	56	MANUAL	C1459	5KC46GN0251Y	✓	\$416	F1	8.8/4.4	21	10.78	19
	1800	115/230	56	NONE	C1458	5KC46GN0251	✓	\$395	F1	8.8/4.4	21	10.78	19
3/4	1800	115/230	56	MANUAL	C1461	5KC46LN0252Y	✓	\$474	F1	13.2/6.6	25	10.78	19
	1800	115/230	56	NONE	C1460	5KC46LN0252	✓	\$459	F1	13.2/6.6	25	10.78	19
1	1800	115/230	56	NONE	C1469	5KC49PN0253	✓	\$553	F1	13.6/6.8	31	11.38	18



## Capacitor Start, TEFC

HP	RPM	VOLTS	FRAME	OVER LOAD	CAT. NO.	MODEL NO.	STOCK	LIST PRICE	MULT. SYMB.	F.L. AMPS	WEIGHT	"C" DIM.	FOOT NOTES
3/4	1800	115/230	56	MANUAL	C1489	5KC46PN0359Y	✓	\$583	F1	11.0/5.5	31	11.83	17



## PSC, Dripproof

HP	RPM	VOLTS	FRAME	OVER LOAD	CAT. NO.	MODEL NO.	STOCK	LIST PRICE	MULT. SYMB.	F.L. AMPS	WEIGHT	"C" DIM.	FOOT NOTES
1/3	1625/1325	115	56	MANUAL	P254	5KCP35KNB650U	✓	\$371	F1	3.8	18	9.94	17
1/2	1625/1325	115	56	MANUAL	PG252	5KCP36NNB670U	✓	\$395	F1	5.4	18	10.33	17
	1625/1325	115	56	MANUAL	P253	5KCP36NNB671U	✓	\$416	F1	5.4	18	10.30	12,17



## PSC, TENV

HP	RPM	VOLTS	FRAME	OVER LOAD	CAT. NO.	MODEL NO.	STOCK	LIST PRICE	MULT. SYMB.	F.L. AMPS	WEIGHT	"C" DIM.	FOOT NOTES
1/2	1625	115	48	AUTO	P247	5KCP35NNA670T	✓	\$327	F1	5.8	18	9.42	17,94,96

DEFINITE PURPOSE

# Kiln Duty, XRI® Premium Efficiency Blue Chip® Severe Duty

## Teao, Rigid Base, Three Phase



### Applications:

Fans found in kilns and other high ambient environments where long life and high efficiency are desired. These TEAO motors must be mounted within the airstream for proper cooling. Suitable for use on variable frequency drives.

### Features:

- Blue Chip® quality, 100% cast iron construction for rigidity and reduced vibration
- Internal and external epoxy paint
- CR<sup>200</sup> Corona resistant magnet wire
- Class H insulation system
- Normally closed thermostats (one per phase, Class H)
- Heat stabilized ball bearings and high temperature grease
- Suitable for inverter use for 20:1 Variable Torque with 1.0 S.F. in 90°C ambient
- Suitable for 90°C ambient at 1.15 S.F. or 100°C ambient at 1.0 S.F.
- Extended grease tubes, regreasable in service
- 8 Foot Leads
- UL Recognized and CSA Certified

HP	RPM	VOLTS	FRAME	CAT. NO.	MODEL NO.	STOCK	LIST PRICE	MULT. SYMB.	NOM. EFF.	F.L. AMPS	WEIGHT	"C" DIM.
1	1200	460	145T	S501	145TTTN18577		\$1,309	E9	80.0	1.7	59	11.43
2	1800	460	145T	S503	145TTTN18531		\$1,309	E9	85.5	2.8	68	11.43
	1800	575	145T	S553	145TTTN18532		\$1,309	E9	85.5	2.3	69	11.43
	1200	460	184T	S504	184TTTS18577		\$1,810	E9	87.5	3.0	115	13.71
	1200	575	184T	S554	184TTTS18578		\$1,810	E9	87.5	2.4	115	13.71
3	1800	460	182T	S506	182TTTS18532		\$1,769	E9	90.2	3.9	99	13.71
	1200	460	213T	S507	213TTTS17077		\$1,922	E9	89.5	4.3	175	15.69
	1200	575	213T	S557	213TTTS17078		\$1,922	E9	89.8	3.5	175	15.69
5	1200	460	215T	S510	215TTTS17077	√	\$2,213	E9	87.5	6.9	185	17.19
	1200	575	215T	S560	215TTTS17078		\$2,213	E9	88.5	5.5	200	17.19
7 1/2	1200	460	254T	S513	254TTTNA17077	√	\$2,714	E9	90.2	9.8	660	20.60
	900	575	256T	S564	256TTTNA18601		\$3,040	E9	88.5	8.6	310	22.35
10	1200	460	256T	S516	256TTTNA18578	√	\$3,112	E9	91.0	12.8	140	22.35
	1200	575	256T	S566	256TTTNA18577		\$3,112	E9	91.0	10.2	425	22.35
	900	460	284T	S517	284TTTNA18601		\$3,226	E9	88.5	15.2	475	23.44
	900	575	284T	S567	284TTTNA17101	√	\$3,226	E9	88.5	12.2	457	23.44,d
15	1800	460	254T	S518	254TTTNA18530		\$2,561	E9	92.4	18.2	276	20.60
	1200	460	284T	S519	284TTTNA16577		\$3,727	E9	91.7	20.5	425	23.44
	1200	575	284T	S569	284TTTNA18577		\$3,727	E9	91.7	16.4	475	23.44
20	1200	460	286T	S522	286TTTNA18577		\$4,082	E9	91.7	27.0	520	24.94
	900	460	324T	S523	324TTTS18601		\$4,988	E9	90.2	29.5	536	26.00
25	1200	460	324T	S525	324TTTS18577		\$5,128	E9	92.4	33.0	675	26.00
30	1200	460	326T	S528	326TTTS18577		\$5,430	E9	93.0	38.0	725	27.50

Blue shaded areas are Cast Iron Frames

DEFINITE PURPOSE

# Oil Well Pump, Three Phase

## Dripproof, Rigid Base

### Applications:

For use on walking beam pumps found in oil field service.

### Features:

- NEMA design D for extra high starting and breakdown torques
- Normally closed thermostats (one per phase, Class F)
- Fully guarded with screens on all external openings
- Copper bar rotor on 500 frame
- Low starting current with 5-8% slip
- Class F insulation
- F2 conduit box location
- Ball bearings (except as noted)
- Shaft slinger
- Special "oil well" duty
- 1.15 Service Factor



DEFINITE PURPOSE

HP	RPM	VOLTS	FRAME	CAT. NO.	MODEL NO.	STOCK	LIST PRICE	MULT. SYMB.	NOM. EFF.	F.L. AMPS	WEIGHT	"C" DIM.	FOOT NOTES
3	1200	230/460/796	215T	Y201	215TTDW7376		\$1,295	S7	82.5	10.6/5.3/3.1	104	17.30	
5	1200	230/460/796	215T	Y202	215TTDW7377		\$1,496	S7	84.0	16.6/8.3/4.8	118	17.30	
7 1/2	1200	230/460/796	254T	Y203	254TTDX7377		\$1,925	S7	85.5	22.0/11.0/6.4	220	21.29	
10	1200	230/460/796	256T	Y204	256TTDX7391	✓	\$2,375	S7	86.5	29.0/14.5/8.4	462	23.04	
15	1200	230/460/796	284T	Y215	284TTDP7692	✓	\$2,872	S7	87.5	41.0/20.5/11.9	330	23.44	
20	1200	230/460/796	286T	Y216	286TTDP7689	✓	\$3,495	S7	87.5	53.0/26.5/15.3	368	24.94	
25	1200	460/796	324T	Y217	324TTDP7687	✓	\$4,290	S7	88.5	34.0/19.7	460	26.00	
30	1200	460/796	326T	Y218	326TTDP7697	✓	\$5,128	S7	88.5	40.0/23.1	498	27.50	
40	1200	460/796	365T	Y209	365TTDS7383		\$6,733	S7	87.5	48.0/27.7	713	29.93	
50	1200	460/796	404T	Y210	404TTDS7387	✓	\$8,135	S7	87.5	60.0/34.5	951	32.81	d
60	1200	460/796	405T	Y211	405TTDS7697		\$9,595	S7	87.5	71.0/41.0	1018	34.31	
75	1200	460/796	444T	Y212	444TTDS8699	✓	\$10,772	S7	90.2	91.5/53.0	1239	38.06	
100	1200	460/796	445T	Y213	445TTDS9477		\$14,363	S7	88.5	124/71.5	1327	40.06	
125	1200	460/796	505U	Y219	505UTDS1584		\$21,042	S7	90.2	145/84.0	1995	45.19	RB
150	1200	460/796	505U	Y220	505UTDS1590		\$22,486	S7	91.0	175/101	2285	45.19	RB

Blue shaded areas are Cast Iron Frames

# Pressure Washer, Single Phase Dripproof

Features:

- Ball bearings, shaft end mechanically locked on C-face models
- Heavy gauge steel constructions
- Capacitor start/capacitor run design for higher efficiency, as noted
- Continuous duty, 1.15 Service Factor (except as noted)
- Thermal protection on some models
- UL Recognized and CSA Certified



## Rigid Base

HP	RPM	VOLTS	FRAME	OVER LOAD	CAT. NO.	MODEL NO.	STOCK	LIST PRICE	MULT. SYMB.	F.L. AMPS	WEIGHT	"C" DIM.	FOOT NOTES
3/4	3600	115	56	MANUAL	9032	5KC49MN2049Y	✓	\$250	F1	12.5	27	11.14	2,17
	1800	115	56	AUTO	9030	5KC49NN0222X		\$348	F1	10.5	16	11.14	2,17
	1800	115/208-230	56	MANUAL	K016	56B17D56	✓	\$348	F1	11.0/5.5-5.5	25	11.47	1
1	3600	115/208-230	56	MANUAL	D010	56B34D2029	✓	\$287	F1	10.6/5.5-5.3	23	11.72	1
	1800	115/230	56	MANUAL	C1480	5KC49PN0161U	✓	\$379	F1	13.6/6.8	31	11.38	2
1 1/2	3600	115/208-230	56	MANUAL	G987	56B34D2021		\$390	F1	14.8/8.0-7.4	26	11.72	1
	1800	115/208-230	56H	MANUAL	G958	56B17D5323	✓	\$461	F1	13.2/7.2-6.6	37	11.94	1,5,14
2	3600	115/208-230	56H	MANUAL	G976	56B34D5304		\$483	F1	17.6/9.7-8.8	34	11.44	1,5,14
	1800	115/208-230	145T	MANUAL	I127	145TBDR5337	✓	\$534	S1	18.8/10.2-9.4	48	13.49	1,14
	1800	115/208-230	56H	MANUAL	G979	56B17D5319		\$608	F1	18.8/10.2-9.4	47	13.44	1,5,14
3	3600	208-230	56H	MANUAL	G996	56B34D5334		\$619	F1	14.2-12.5	44	12.44	1,5,14
	1800	208-230	184T	NONE	I128	184TBDR7631	✓	\$624	S1	15.4-13.7	71	15.22	d,1
	1800	208-230	184T	NONE	I128A	184TBDW7631	✓	\$624	S1	13.8-12.8	71	13.69	1,13
	1800	208-230	184T	MANUAL	I130A	184TBDW7630	✓	\$676	S1	13.8-12.8	70	13.69	1,13
5	1800	208-230	184T	MANUAL	I119	184TBDR7375		\$891	S1	25.0-24.1	83	16.22	1
	1800	208-230	184T	NONE	I131	184TBDR7632	✓	\$900	S1	25.0-24.1	83	16.22	d,1
	1800	208-230	184T	NONE	I131A	184TBDW7632	✓	\$900	S1	22.0-20.0	89	15.19	1,13

DEFINITE PURPOSE



## C-Face Footed (Rigid Base)

HP	RPM	VOLTS	FRAME	OVER LOAD	CAT. NO.	MODEL NO.	STOCK	LIST PRICE	MULT. SYMB.	F.L. AMPS	WEIGHT	"C" DIM.	FOOT NOTES
1 1/2	3600	115/208-230	56C	MANUAL	K212	56B34D2018		\$409	F1	14.8/8.0-7.4	26	11.72	
	1800	115/208-230	56HC	MANUAL	G290	56B17D5328		\$478	F1	13.2/7.2-6.6	39	11.94	5
2	3600	115/208-230	56HC	MANUAL	G294	56B34D5307		\$499	F1	16.8/9.4-8.4	34	11.44	5
	1800	115/208-230	56HC	MANUAL	K232	56B17D5322	✓	\$596	F1	18.8/10.2-9.4	49	13.43	5
3	3600	208-230	56HC	MANUAL	K219	56B34D5336		\$635	F1	14.2-12.5	42	12.44	5
	1800	208-230	184TC	MANUAL	I305	184TBDR7628		\$741	S1	15.4-13.7	83	15.96	1
5	1800	208-230	184TC	MANUAL	I308	184TBDR7634		\$1,020	S1	25.0-24.1	97	16.96	1

# Pressure Washer, Single Phase

## Totally Enclosed Fan Cooled

### Features:

- Ball bearings, shaft end mechanically locked on C-face models
- Heavy gauge steel constructions
- Capacitor start/capacitor run design for higher efficiency, as noted
- Continuous duty, 1.15 Service Factor
- Manual reset thermal protector
- UL Recognized and CSA Certified



### Rigid Base

HP	RPM	VOLTS	FRAME	CAT. NO.	MODEL NO.	STOCK	LIST PRICE	MULT. SYMB.	F.L. AMPS	WEIGHT	"C" DIM.	FOOT NOTES
3/4	3600	115/208-230	56	G379	56C34F5309	✓	\$278	F1	10.6/5.3-5.3	26	12.32	2,14
	1800	115/208-230	56	G356	56C17F5308	✓	\$384	F1	11.0/5.4-5.5	29	12.32	2,14
1	3600	115/208-230	56	G390	56C34F5311	✓	\$315	F1	12.4/6.7-6.2	31	12.32	2,14
	1800	115/208-230	56	G373	56C17F5311	✓	\$402	F1	13.4/6.8-6.7	30	12.82	2,14
1 1/2	3600	115/208-230	56	K332	56B34F5303		\$427	F1	12.1/6.9-6.1	37	13.32	1,14
	1800	115/208-230	56H	G378	56B17F5302	✓	\$461	F1	15.2/8.2-7.6	40	13.82	1,5,14
2	1800	115/230	145T	I702	145TBFR5336		\$591	S1	18.8/9.4	52	14.87	1,14

DEFINITE PURPOSE



### C-Face Footed (Rigid Base)

HP	RPM	VOLTS	FRAME	CAT. NO.	MODEL NO.	STOCK	LIST PRICE	MULT. SYMB.	F.L. AMPS	WEIGHT	"C" DIM.	FOOT NOTES
1/2	1800	115/208-230	56C	G380	56C17F5957		\$355	F1	8.8/4.2-4.4	27	11.82	2
3/4	1800	115/208-230	56C	G381	56C17F5955	✓	\$425	F1	11/5.4-5.5	22	12.32	2
1	1800	115/208-230	56C	G382	56C17F5956	✓	\$444	F1	13.4/6.8-6.7	31	12.82	2
1 1/2	3600	115/208-230	56C	K612	56B34F5306	✓	\$443	F1	12.1/6.9-6.0	37	13.32	1
	1800	115/208-230	56HC	G396	56B17F5310	✓	\$506	F1	13.6/7.5-6.8	43	13.82	1,5
2	3600	115/230	56HC	K615	56B34F5312	✓	\$526	F1	17.5/8.7	37	13.32	1,5
	1800	115/230	145TC	I311	145TBFR5333		\$716	S1	18.8/9.4	52	14.87	1
	1800	115/230	56HC	K319	56B17F5319	✓	\$601	F1	18.8/9.4	50	14.82	1,5
3	3600	230	56HC	K618	56B34F5318	✓	\$663	F1	11.8	51	14.82	1,5
	1800	230	184TC	I314A	184TBFW7041	✓	\$896	S1	12.8	86	14.96	1,13
5	1800	230	184TC	I315A	184TBFW7034	✓	\$1,069	S1	19.5	101	17.47	1,13,17



# Woodworking/Power Tool, Single Phase

## Totally Enclosed, Rigid Base

### Applications:

Replacement motors for table saws, planers, lathes, and other equipment found in the woodworking and metalworking trades. These totally enclosed, fan cooled motors are well suited for use in dusty and dirty environments or where wood or metal shavings are present.

### Features:

- Capacitor start design for high starting torque with low amps
- Double sealed ball bearings
- Heavy gauge steel frame and base
- 1.15 Service Factor
- Manual reset thermal protector
- Dependable, dust-proof centrifugal starting switch
- On/off toggle switch and 8 foot cord with 115 volt plug included on 1/2 to 1-1/2 HP models
- UL Recognized and CSA Certified



HP	RPM	VOLTS	FRAME	CAT. NO.	MODEL NO.	STOCK	LIST PRICE	MULT. SYMB.	F.L. AMPS	WEIGHT	"C" DIM.	FOOT NOTES
1/2	1800	115/208-230	56	T010	56C17F5351	✓	\$367	F1	8.8/4.2-4.4	29	11.82	2
3/4	3600	115/208-230	56	T013	56C34F5340	✓	\$332	F1	10.6/5.3-5.3	27	12.32	2
	1800	115/208-230	56	T014	56C17F5350	✓	\$429	F1	11.0/5.4-5.5	30	12.32	2
1	3600	115/208-230	56	T015	56C34F5339	✓	\$369	F1	12.4/6.7-6.2	30	12.32	2
	1800	115/208-230	56	T016	56C17F5349	✓	\$454	F1	13.4/6.8-6.7	31	12.82	2,d
1 1/2	3600	115/208-230	56	T017	56B34F5332	✓	\$453	F1	14.2/7.7-7.1	33	12.82	1
	1800	115/208-230	56	T018	56B17F5328	✓	\$551	F1	13.6/7.5-6.8	44	13.73	1
2	3600	115/230	56H	T019	56B34F5333	✓	\$493	F1	17.5/8.7	36	13.41	1,5
	1800	115/230	56H	T030	56B17F5329	✓	\$608	F1	18.8/9.4	50	14.82	1,5
3	3600	208-230	145T	T031	145TBFR5309	✓	\$684	S1	13.1/11.8	51	14.87	1

# 50 Hertz, Three Phase

## Dripproof, Rigid Base

### Features:

- Ball bearings
- 1.15 Service Factor
- Nameplated 190-200-208/380-400-416 (except as noted)
- 12 Lead delta capability
- UL Recognized and CSA Certified



HP	RPM	VOLTS	FRAME	CAT. NO.	MODEL NO.	STOCK	LIST PRICE	MULT. SYMB.	NOM. EFF.	F.L. AMPS	WEIGHT	"C" DIM.	FOOT NOTES
2	1500	220/380	145T	KG319	5K49UN8052		\$458	E6	81.5	6.4/3.7	40	14.24	
3	1500	190-208/380-416	182T	H953	182TTDR8353	✓	\$510	E6	81.5	10.0-9.8/5.0-4.9	60	13.22	F,YD,25
5	1500	190-208/380-416	184T	H954	184TTDR9040	✓	\$648	E6	82.5	16.2-15.6/8.1-7.8	80	14.72	F,YD,25
7 1/2	1500	190-208/380-416	213T	H955	213TTDW7053		\$851	E6	85.5	22.6-19.0/9.5-11.3	106	17.30	YD
10	1500	190-208/380-416	215T	H956	215TTDW7053		\$1,013	E6	88.5	31.0-29.1/15.5-14.5	135	17.30	YD
15	1500	190-208/380-416	254T	H957	254TTDX8338	✓	\$1,341	E6	88.5	46.0-44.0/23.0-22.0	180	22.32	F,YD

DEFINITE PURPOSE

# MOD CENTRAL - Motor Modifications

## Mod Central

Marathon Motors offers the capability to modify stock motors in a matter of days to meet our customer's special needs. Mod Central is centrally located in the motor industry's largest Distribution Center in Indianapolis, Indiana. This state-of-the-art facility stocks a vast array of motors and accessories along with a staff of skilled technicians who provide the highest quality of service. If you need motor modifications on 20 motors or less and want to avoid special engineering and manufacturing schedules, call Marathon Motors and take advantage of our **MOD CENTRAL** Motor Modification Program.

## Lead-Time

All lead-times indicated are subject to availability of the stock motors and parts at the time of order placement. If a stock motor is shipped from a remote warehouse to Indianapolis for modification, the cost of the inbound freight will be added to the price of the modified motor and the delivery of the modified motor will be extended by the inbound transit time. **(Lead-times in working days are calculated from normal business hours excluding holidays and weekends and do not include the day the purchase order is received.)** Large quantities may require additional lead-time.

## Mod Central Hours

The Modification Center is open from 7:00 a.m. to 5:00 p.m. CST Monday through Friday.

## How to Order

First determine whether you need a kit to perform the modification, if you do not need a kit, then the modification list price includes all supplies to perform that modification. If a kit is needed, the modification list price is the labor to install the kit. The kit list price and the motor list price are not included. You must add the net price of the motor, and kit to the net price of the modification(s) to calculate the total price of the modified motor.

For example, to add a C-Face Kit and Thermostats to Catalog Motor U633, you would calculate the total price as follows:

	List Price	Mult Symbol
Kit 175191 (A653).....	\$165 list	S4
Modification MOD2L, add C-Face to 254T-256T Frame motor .....	\$195 list	S4
Modification MOD14E, add thermostats to 254T-256T Frame motor .....	\$278 list	S4
<b>TOTAL</b> .....	<b>\$638 list</b>	

Add the net price of U633 (\$1324 list price times (x) your motor multiplier) to the net adder for the kit and modifications (\$638 times (x) your Mod Center multiplier of S4) to find the total net price for the modified motor.

## Freight Terms

Standard terms and conditions apply.

## Exceptions

Some modifications do not apply to explosion proof motors.

## Discount Multiplier

Discount symbol S4 applies to all list prices, except where noted.

## Cancellation Policy

If a Mod Central order is cancelled after the motor is modified but before it ships, a cancellation charge of double the modification charge will be invoiced to the customer. Any Mod Central order cancelled before modifications are completed, is subject to a cancellation charge of 25% of the total modification charges for that item.

**Once shipped, modified motors may not be returned for credit or restocking.**

# MOD CENTRAL - Motor Modifications

MODIFICATION DESCRIPTION	MODIFICATION NUMBER	PRODUCT	FRAME	LEAD-TIME DAYS*
<b>Altitude/Ambient</b>				
• AC Motor Altitude or Ambient Re-Rating	MOD7	All Non-EXP	48-449T	2
• AC Motor Altitude or Ambient Re-Rating	MOD7	Explosion Proof	143T-449T	2
<b>Assembly (see Mounting)</b>				
<b>Bearings</b>				
• Convert Ball to Roller (Drive End)	MOD18	TEFC	364T-449T	3
• Convert Roller to Ball (Drive End)	MOD18	TEFC	444T-449T	2
• Sealed Bearing	MOD18	All Non-EXP	143T-449T	Call
• Insulated Bearing	MOD18	Non Div 1 or 2	143T-449T	Call
<b>Blowers</b>				
• Axial Blower	MOD19	TEFC	213T-449T	3
<b>Brackets</b>				
• C-Face Non-Explosion Proof	MOD2	All Non-EXP	56-449T	2
• C-Face Explosion Proof	MOD2	Explosion Proof	56,254T-449T	Call
• C-Face IEEE 841	MOD2	All Non-EXP	143T-449T	2
• D-Flange	MOD17	All Non-EXP	254T-365T	Call
• B14 FT Flange (IEC C-Face)	MOD55	IEC	63-160	2
• B5 FF Flange (IEC D-Flange)	MOD55	IEC	63-225	2
<b>Brake Motors</b>				
• Brake Motors-Single Phase	MOD3	TEFC	56C	3
• Brake Motors-Three Phase	MOD3	TEFC	56C-145TC	3
• Brake Motors-Inverter Duty	MOD3	TENV	56C-326TC	3
• Electrical Modifications-Brake Coil	MOD3	Brake Motors	56-256TC	10
• Vertical Brake Mounting (Shaft Up or Shaft Down)	MOD3	All Brakes	56-256TC	3
<b>Conduit Box</b>				
• Rotate Conduit Box Lead Opening	MOD56	All Non-EXP	143T-449T	2
• Convert to Cast Iron	MOD56	All Non-EXP	143T-326T	2
• Auxiliary Box (Condulet)	MOD56	All Non-EXP	182T-5013L	Call
<b>Connections</b>				
• SO Cord, Plug, and Switch-Single Phase	MOD0	TEFC	48-215T	Call
<b>Drains</b>				
• Condensation Drain Holes	MOD21	All Non-EXP	143T-449T	2
• Brass Drain & Breather	MOD21	All Non-EXP	143T-449T	2
• Stainless Steel Drain & Breather	MOD21	All Non-EXP	143T-449T	2
<b>Drip Covers</b>				
• Canopy Cover	MOD4	ODP, TEFC	48-256T	2
<b>Encoders</b>				
• Avtron AV56 - Black Max® / Blue Max®	MOD22	TENV, TEBC	56-449T	2
• Avtron HS25A & HS35A	MOD22	TENV, TEBC	56-449T	2
• Avtron M56/M85 - Black Max®/ Blue Max® brake motors	MOD24	TENV	143T-256T	2
• Northstar SL56 - Black Max®/Blue Max®	MOD22	TENV, TEBC	56-449T	2
• Northstar SL56/SL85 - Black Max®/ Blue Max® brake motors	MOD24	TENV	143T-256T	2
• Dynapar HS20, HS35R, & HSD38 - Black Max® / Blue Max®	MOD22	TENV, TEFC, TEBC	56-449T	2
• BEI HS35 - Black Max®/Blue Max®	MOD31	TENV, TEFC, TEBC	56-449T	2
• Stub Shaft (XRI®-SD & XRI®-841, TEFC only)	MOD42	TEFC	182-449T	2
<b>Fan</b>				
• Oversized fan (see Inverter Duty modification)	MOD43	TEFC	213T-449T	2
• Fan Removal	MOD44	All Non-EXP	56-449T	2
• Vane Axial	MOD43	All Non-Exp	143T-449T	4
<b>Frequency</b>				
• Frequency Re-Rate 60 Hz to 50 Hz	MOD7	All	56-449T	1
<b>Grease/Fittings</b>				
• Grease Relief Fittings	MOD15	All Non-EXP	143T-449T	2
• Zerk Fittings (Cast Iron Motors)	MOD15	All Non-EXP	182T-449T	2
• Low Temperature Grease	MOD0	All	48-449T	2
• High Temperature Grease	MOD0	All	48-449T	2

\*Lead-time days does not include the day order is received

# MOD CENTRAL - Motor Modifications

MODIFICATION DESCRIPTION	MODIFICATION NUMBER	PRODUCT	FRAME	LEAD-TIME DAYS*
<b>Grounding</b>				
• Conduit Box Grounding Lug	MOD20	All	48-215T	2
• On-Frame Grounding (Cast Iron Motors)	MOD20	All	143T-449T	2
• Shaft Grounding Ring	MOD20	Call	48-449T	2
<b>Inverter Duty Motors</b>				
• Variable Torque with Thermostats (R140)	MOD25	All	143T-449T	2
• Constant Torque with Thermostats (R142)	MOD26	All	143T-449T	2
• Constant Torque (R164)	MOD43	All	143T-449T	2
<b>Leads</b>				
• Reconnect Leads	MOD9	All	48-449T	2
• Terminal Lugs	MOD0	All	48-326T	2
• Remark Leads	MOD33	All	48-449T	2
• Longer Leads - Up to 24"	MOD0	All Non-EXP	48-449T	2
<b>Mounting/Assembly (Example: F1 to F2)</b>				
• Convert to Floor, Top, Ceiling, or Wall	MOD1	All Non-EXP	143T-449T	2
• Convert to Floor, Top, Ceiling, or Wall	MOD39	Explosion Proof	143T-449T	2
• Adjustable Bases	MOD39	All	143T-449T	2
<b>Nameplates / Markings</b>				
• Additional Data on Nameplate	MOD7	All	48-449T	1
• CE Marking	MOD7	All	48-449T	2
• Private Label	MOD7	All	48-449T	1
• Rotation Arrow	MOD7	Single Phase	48-215T	1
• Separate Nameplate for Customer Data	MOD7	All	48-449T	2
• Stainless Steel Nameplate	MOD7	All	48-449T	1
<b>Packaging</b>				
• Heat Treated Pallet	MOD29	All	48-449T	3
<b>Paint</b>				
• Repaint to a Marathon stock color	MOD8	All	48-449T	2-3
<b>Screens</b>				
• Rodent Screens	MOD0	ODP	364T-449T	Call
<b>Service Factor</b>				
• AC Motor Service Factor Re-Rating	MOD7	All Non-EXP	48-449T	1
<b>Severe Duty Construction</b>				
• Cast Iron Fan Cover and Conduit Box	MOD16	All Non-EXP	143T-449T	2
<b>Shaft Grounding Ring (see Grounding)</b>				
<b>Shaft Modifications</b>				
• Drill & Tap Hole	MOD42	All	56-449T	3
• TS Shaft	MOD42	All	284T-449T	2
• Mill Flat on Shaft	MOD0	All	56-184T	2
• Steps on Shaft	MOD0	All	143T-449T	Call
<b>Space Heaters</b>				
• Non Explosion Proof	MOD12	All Non-EXP	48-449T	2
• Explosion Proof	MOD41	Explosion Proof	56-449T	2
• IEC Frames	MOD12	IEC	100-250	2
<b>Terminal Blocks</b>				
• Terminal Block	MOD0	All Non-EXP	180-449T	Call
<b>Thermal Protection</b>				
• Thermostats - Windings	MOD14	All	56-449T	2
• Thermistors - Windings	MOD14	All	143T-449T	2
• Thermistors (including Control Module)	MOD14	All Non-EXP	143T-449T	2
• Thermocouples - Winding or Bearing	MOD0	All Non-EXP	145T-449T	2
<b>Weatherproofing / Special Service</b>				
• Tropical Anti-Fungus Treatment	MOD5	All	48-449T	2
• Division 2 Motors (CSA Certified)	MOD49	Blue Chip®/XRI®	143T-449T	Call

\*Lead-time days does not include the day order is received

# MOD CENTRAL - Stock Motors Only

Mult. Symbol is S4 (except as noted)

Contact Marathon Motors for all modification services on Explosion Proof and Blower (TEBC) motors.

NEMA MOTORS

DESCRIPTION	KIT REQ'D	LIST PRICE												
		MOD #	48	56	143-145	182-184	213-215	254-256	284-286	324-326	364-365	404-405	444-445	447-449
Altitude / Ambient		7	\$114	\$114	\$114	\$114	\$114	\$114	\$114	\$114	\$114	\$114	\$114	\$114
<b>Bearings</b>														
Convert Ball to Roller (Drive End)	Yes	18	-----	-----	-----	-----	-----	-----	-----	-----	\$200	\$200	\$250	\$250
Convert Roller to Ball (Drive End)	Yes	18	-----	-----	-----	-----	-----	-----	-----	-----	-----	-----	\$250	\$250
Sealed Bearings		18	\$197	\$197	\$197	\$263	\$263	\$362	\$461	\$625	\$1,084	\$1,084	\$1,478	\$1,478
Insulated Bearings		18	-----	-----	\$461	\$526	\$526	\$1,530	\$1,645	\$1,645	\$1,737	\$1,776	\$1,882	\$2,061
<b>Blowers</b>														
Axial Blower	Yes	19	-----	-----	-----	-----	\$308	\$270	\$270	\$270	\$520	\$520	\$520	\$520
<b>Brackets*</b>														
C-Face (Non-Explosion Proof)	Yes	2	-----	\$143	\$143	\$168	\$168	\$195	\$290	\$329	\$329	\$329	\$329	\$329
C-Face (Explosion Proof)	Yes	2	-----	\$238	-----	-----	-----	\$325	\$483	\$648	\$648	\$648	\$948	\$948
C-Face (IEEE 841)	Yes	2	-----	-----	\$238	\$280	\$280	\$325	\$425	\$489	\$489	\$489	\$489	\$489
D-Flange	Yes	17	-----	-----	-----	-----	-----	\$168	\$240	\$408	\$408	-----	-----	-----
<b>Brakes</b>														
3 lb-ft for a TEFC motor	Yes	3	-----	\$165	\$165	-----	-----	-----	-----	-----	-----	-----	-----	-----
6 lb-ft for a TEFC motor	Yes	3	-----	\$165	\$165	-----	-----	-----	-----	-----	-----	-----	-----	-----
10 lb-ft for a TEFC motor	Yes	3	-----	\$165	\$165	-----	-----	-----	-----	-----	-----	-----	-----	-----
6 lb-ft for a Black Max (TENV) motor	Yes	3	-----	\$165	\$165	\$165	\$165	-----	-----	-----	-----	-----	-----	-----
10 lb-ft for a Black Max (TENV) motor	Yes	3	-----	\$165	\$165	\$165	\$165	\$165	\$165	-----	-----	-----	-----	-----
Brake Coil (56000 Series)		3	-----	\$410	\$410	\$410	-----	-----	-----	-----	-----	-----	-----	-----
Brake Coil (87000 Series)		3	-----	-----	-----	\$510	\$510	\$510	-----	-----	-----	-----	-----	-----
Vertical Mounting - Up or Down	Yes	3	-----	-----	-----	-----	\$73	\$73	-----	-----	-----	-----	-----	-----
Vertical Mounting - Shaft Down	Yes	3	-----	-----	-----	-----	\$73	\$73	-----	-----	-----	-----	-----	-----
<b>Conduit Box</b>														
Rotate Conduit Box Lead Opening		56	-----	-----	\$145	\$145	\$145	\$145	\$145	\$145	\$145	\$145	\$145	\$145
Convert to Cast Iron	Yes	56	-----	-----	\$158	\$158	\$158	\$174	\$188	\$217	-----	-----	-----	-----
Auxiliary Box (Condulet)		56	-----	-----	-----	\$217	\$217	\$289	\$289	\$289	\$434	\$434	\$434	\$434
<b>Connections:</b>														
SO Cord, Plug, and Switch Single Phase		0	\$287	\$287	\$287	\$287	\$287	-----	-----	-----	-----	-----	-----	-----
<b>Drains</b>														
Condensation Drain Holes		21	-----	-----	\$171	\$171	\$171	\$191	\$191	\$191	\$191	\$191	\$191	\$191
Brass Drain & Breather		21	-----	-----	\$182	\$182	\$182	\$326	\$326	\$326	\$326	\$326	\$326	\$326
Stainless Steel Drain & Breather		21	-----	-----	\$263	\$263	\$263	\$471	\$471	\$471	\$471	\$471	\$471	\$471
<b>Drip Cover</b>														
Canopy Cover (ODP & TEFC Motors)	Yes	4	\$121	\$121	\$121	\$121	\$160	\$256	-----	-----	-----	-----	-----	-----
<b>Encoders (NOTE: Multiplier Symbol E3)</b>														
Avtron AV56	Yes	22	-----	\$0	\$0	\$0	\$0	\$0	-----	-----	-----	-----	-----	-----
Avtron HS25A	Yes	22	-----	\$0	\$0	\$0	\$0	\$0	-----	-----	-----	-----	-----	-----
Avtron HS35A	Yes	22	-----	\$0	\$0	\$0	\$0	\$0	\$0	\$0	\$0	\$0	\$0	\$0
Avtron HS35M	Yes	22	-----	\$0	\$0	\$0	\$0	\$0	\$0	\$0	\$0	\$0	\$0	\$0
Avtron M3	Yes	22	-----	\$0	\$0	\$0	\$0	\$0	\$0	\$0	\$0	\$0	\$0	\$0
BEI HS35	Yes	22	-----	\$0	\$0	\$0	\$0	\$0	\$0	\$0	\$0	\$0	\$0	\$0
Dynapar HS20	Yes	22	-----	\$0	\$0	\$0	\$0	\$0	-----	-----	-----	-----	-----	-----
Dynapar HS35R	Yes	22	-----	\$0	\$0	\$0	\$0	\$0	\$0	\$0	\$0	\$0	\$0	\$0
EPC 260	Yes	22	-----	\$0	\$0	\$0	\$0	\$0	-----	-----	-----	-----	-----	-----
NorthStar HSD35	Yes	22	-----	\$0	\$0	\$0	\$0	\$0	\$0	\$0	\$0	\$0	\$0	\$0
NorthStar SL56	Yes	22	-----	\$0	\$0	\$0	\$0	\$0	-----	-----	-----	-----	-----	-----
<b>Blue Max TEBC Encoders:</b>														
Avtron HS35A	Yes	24	-----	-----	-----	-----	-----	-----	\$0	\$0	\$0	\$0	\$0	\$0
Avtron AV56	Yes	24	-----	-----	-----	-----	-----	-----	\$0	\$0	\$0	\$0	\$0	\$0
Dynapar HSD38	Yes	24	-----	-----	-----	-----	-----	-----	\$0	\$0	\$0	\$0	\$0	\$0
NorthStar SL56	Yes	24	-----	-----	-----	-----	-----	-----	\$0	\$0	\$0	\$0	\$0	\$0
Turck A02H	Yes	24	-----	-----	-----	-----	-----	-----	\$0	\$0	\$0	\$0	\$0	\$0
<b>Blue Max Brakemotor Encoders:</b>														
Avtron AV56	Yes	24	-----	-----	\$0	\$0	-----	-----	-----	-----	-----	-----	-----	-----
Avtron M85	Yes	24	-----	-----	-----	\$0	\$0	\$0	-----	-----	-----	-----	-----	-----
NorthStar SL56	Yes	24	-----	-----	\$0	\$0	-----	-----	-----	-----	-----	-----	-----	-----
NorthStar SL85	Yes	24	-----	-----	-----	\$0	\$0	\$0	-----	-----	-----	-----	-----	-----
Stub Shaft: (XRI®-SD & XRI®-841, TEFC only)	Yes	42	-----	-----	-----	\$182	\$182	\$182	\$182	\$182	\$182	\$182	\$182	\$182
<b>Fan</b>														
Oversized fan (Inverter Duty)		43	-----	-----	-----	-----	\$230	\$263	\$263	\$263	\$296	\$329	\$329	\$329
Fan Removal		44	-----	\$145	\$145	\$182	\$182	\$217	\$217	\$217	\$254	\$254	\$254	\$254
Vane Axial		43	-----	-----	\$315	\$623	\$623	\$934	\$934	\$934	\$1,231	\$1,231	\$1,231	\$1,231
<b>Frequency</b>														
Re-Rate 60Hz to 50Hz		7	\$114	\$114	\$114	\$114	\$114	\$114	\$114	\$114	\$114	\$114	\$114	\$114
<b>Grease/Fittings</b>														
Grease Relief Fittings		15	-----	-----	\$174	\$174	\$174	\$174	\$174	\$174	\$174	\$174	\$174	\$174
Zerk Fittings (Cast Iron Motors)		15	-----	-----	-----	\$276	\$276	\$276	\$276	\$276	\$276	\$276	\$276	\$276
Low Temperature Grease		0	\$461	\$461	\$461	\$816	\$816	\$816	\$816	\$816	\$1,092	\$1,461	\$1,461	\$1,461
High Temperature Grease		0	\$461	\$461	\$461	\$816	\$816	\$816	\$816	\$816	\$1,092	\$1,461	\$1,461	\$1,461

\*Addition of C-Face Kits may result in non-NEMA "BA", dimension. For the resulting "BA" dimension consult chart found in modification section

# MOD CENTRAL - Stock Motors Only

Mult. Symbol is S4 (except as noted)

Contact Marathon Motors for all modification services on Explosion Proof and Blower (TEBC) motors.

DESCRIPTION	KIT REQ'D	LIST PRICE												
		MOD #	48	56	143-145	182-184	213-215	254-256	284-286	324-326	364-365	404-405	444-445	447- 449
<b>Grounding:</b>														
Conduit Box Grounding Lug		20	\$105	\$105	\$105	\$118	\$118	-----	-----	-----	-----	-----	-----	-----
On-Frame Grounding (Cast Iron Motors)		20	-----	-----	\$145	\$158	\$158	\$239	\$239	\$239	\$334	\$334	\$334	\$334
Shaft Grounding Ring	Yes	20	\$177	\$177	\$177	\$204	\$204	\$292	\$292	\$403	\$531	\$553	\$776	\$776
<b>Inverter Duty Motors:</b>														
Variable Torque (R140)		25	-----	-----	\$278	\$278	\$278	\$278	\$278	\$278	\$278	\$278	\$278	\$278
Constant Torque (fan chg, t-stats, re-nameplate)		26	-----	-----	\$278	\$278	\$278	\$441	\$441	\$441	\$441	\$542	\$542	\$542
Constant Torque (R164, fan chg, re-nameplate)		43	-----	-----	\$230	\$230	\$230	\$263	\$263	\$263	\$296	\$329	\$329	\$329
<b>Leads:</b>														
Reconnect Leads (Non-Explosion Proof)		9	\$168	\$168	\$168	\$249	\$249	\$439	\$439	\$439	\$575	\$575	\$575	\$575
Reconnect Leads (Explosion Proof)		40	\$271	\$271	\$271	\$417	\$417	\$562	\$562	\$562	\$709	\$709	\$709	\$709
Remark Leads		33	\$176	\$176	\$176	\$176	\$176	\$176	\$176	\$176	\$176	\$176	\$176	\$176
Longer Leads - Up to 24"		0	\$138	\$138	\$138	\$207	\$207	\$362	\$362	\$362	\$507	\$507	\$507	\$507
<b>Mounting/ Assembly: (Ex. F1 to F2):</b>														
Non-Explosion Proof		1	-----	-----	\$209	\$209	\$209	\$278	\$278	\$278	\$347	\$347	\$347	\$347
Explosion Proof		39	-----	-----	\$487	\$487	\$487	\$555	\$555	\$555	\$626	\$626	\$626	\$626
Adjustable Motor Bases	Yes	39	-----	-----	\$143	\$143	\$143	\$143	\$143	\$143	\$143	\$143	\$143	\$143
Transition Motor Bases	Yes	39	-----	-----	\$143	\$143	\$143	\$143	\$143	\$143	\$143	\$143	\$143	\$143
<b>Nameplates / Markings:</b>														
Additional Data on Nameplate		7	\$114	\$114	\$114	\$114	\$114	\$114	\$114	\$114	\$114	\$114	\$114	\$114
CE Marking		7	\$114	\$114	\$114	\$114	\$114	\$114	\$114	\$114	\$114	\$114	\$114	\$114
Private Label		7	\$114	\$114	\$114	\$114	\$114	\$114	\$114	\$114	\$114	\$114	\$114	\$114
Rotation Arrow		7	\$114	\$114	\$114	\$114	\$114	-----	-----	-----	-----	-----	-----	-----
Stainless Steel Nameplate		7	\$114	\$114	\$114	\$114	\$114	\$114	\$114	\$114	\$114	\$114	\$114	\$114
Separate Nameplate for Customer Data		7	\$114	\$114	\$114	\$114	\$114	\$114	\$114	\$114	\$114	\$114	\$114	\$114
<b>Packaging:</b>														
Heat Treated Pallets		29	\$50	\$50	\$50	\$50	\$125	\$125	\$250	\$250	\$250	\$250	\$250	\$250
<b>Paint:</b>														
Repaint to a Marathon Stock Color		8	\$211	\$211	\$211	\$211	\$211	\$263	\$263	\$263	\$461	\$461	\$461	\$592
<b>Screens:</b>														
Rodent Screens		0	-----	-----	-----	-----	-----	-----	-----	-----	\$661	\$661	\$661	\$661
<b>Service Factor:</b>														
AC Motor Service Factor Re-Rating		7	\$114	\$114	\$114	\$114	\$114	\$114	\$114	\$114	\$114	\$114	\$114	\$114
<b>Severe Duty Construction:</b>														
Cast Iron Fan Cover and Conduit Box	Yes	16	-----	-----	\$147	\$181	\$200	\$225	\$225	\$225	\$273	\$273	\$273	-----
<b>Shaft Modifications:</b>														
Drill & Tap Hole		42	-----	\$174	\$174	\$197	\$257	\$316	\$316	\$458	\$507	\$572	\$724	\$724
TS Shaft		42	-----	-----	-----	-----	-----	-----	\$1,579	\$1,579	\$1,711	\$1,911	\$1,911	\$1,911
Mill Flat on Shaft		0	-----	\$174	\$174	\$197	-----	-----	-----	-----	-----	-----	-----	-----
Steps on Shaft		0	-----	-----	\$217	\$289	\$289	\$362	\$434	\$507	\$579	\$651	\$724	\$796
<b>Space Heaters:</b>														
Non Explosion Proof		12	\$278	\$278	\$278	\$400	\$400	\$471	\$471	\$471	\$661	\$661	\$661	\$661
Explosion Proof		41	-----	\$417	\$417	\$525	\$525	\$661	\$661	\$661	\$800	\$800	\$800	\$800
<b>Terminal Blocks:</b>														
Terminal Block	Yes	0	-----	-----	-----	\$294	\$294	\$351	\$351	\$351	\$358	\$358	\$437	\$437
<b>Thermal Protection:</b>														
Thermostats (Non Explosion Proof)		14	-----	\$278	\$278	\$278	\$278	\$278	\$278	\$278	\$278	\$278	\$278	\$278
Thermostats (Explosion Proof Motors)		14	-----	\$556	\$556	\$556	\$556	\$556	\$556	\$556	\$556	\$556	\$556	\$556
Thermistors (Non Explosion Proof motors)		14	-----	-----	\$522	\$522	\$522	\$522	\$522	\$522	\$522	\$522	\$522	\$522
Thermistors (Explosion Proof motors)		14	-----	-----	\$1,053	\$1,053	\$1,053	\$1,053	\$1,053	\$1,053	\$1,053	\$1,053	\$1,053	\$1,053
Thermistors (including Control Module)		14	-----	-----	\$1,391	\$1,391	\$1,391	\$1,391	\$1,391	\$1,391	\$1,391	\$1,391	\$1,391	\$1,391
Thermocouples - Winding or Bearing (Non XP)		0	-----	-----	\$305	\$305	\$305	\$399	\$399	\$399	\$575	\$575	\$575	\$575
<b>Weatherproofing / Special Service:</b>														
Tropical Anti- Fungus Treatment		5	\$242	\$242	\$242	\$242	\$242	\$313	\$313	\$313	\$382	\$382	\$382	\$382
Division 2 Hazardous (CSA Certified)		49	-----	-----	\$114	\$339	\$339	\$441	\$441	\$441	\$224	\$224	\$224	\$224
Other Modifications:		0	CONSULT FACTORY											

MODIFICATIONS THROUGH MOD CENTRAL

## IEC Motors

DESCRIPTION	KIT REQ'D	LIST PRICE												
		MOD #	63	71	80	90	100	112	132	160	180	200	225	250
<b>Brackets</b>														
FF Flange (B5)	Yes	55	\$158	\$162	\$170	\$179	\$200	\$221	\$221	\$221	\$221	\$221	\$221	\$221
FT Flange (B14)	Yes	55	\$158	\$162	\$170	\$179	\$200	\$221	\$221	\$221	\$221	-----	-----	-----
<b>Space Heaters:</b>														
		12	-----	-----	-----	-----	\$405	\$502	\$502	\$554	\$554	\$554	\$639	\$693
<b>Packaging:</b>														
Heat Treated Pallets		29	\$95	\$95	\$95	\$95	\$250	\$250	\$250	\$325	\$325	\$325	\$325	\$325
Other Modifications:		0	CONSULT FACTORY											

# MOD CENTRAL - Motor Modifications

## Altitude/Ambient - MOD7 (Mult. Symbol S4)

The rating of standard motors assumes operation at sea level. Listed motors are suitable for operation at altitudes up to 3,300 feet in a maximum ambient temperature of 40°C. The ambient temperature is the temperature of the cooling medium surrounding the motor. All standard motors are suitable for operation over the range of -15°C to 40°C ambient per NEMA MG-1.

**AC Motor Altitude or Ambient Re-Rating** Re-rating of a non-explosion proof motor can be done by evaluating the performance data and possibly changing the Service Factor. Contact Marathon Motors for motor capabilities prior to motor selection and modification.

## Bearings - MOD18 (Mult. Symbol S4)

Most standard motors use anti-friction deep groove Conrad type ball bearing, sized for the loads to be expected in industrial applications. Roller bearings are used on the drive end to handle heavy or overhung (radial) shaft loads.

### Ball to Roller Bearing

Roller bearings have the capability to handle higher radial loads than ball bearings, but must have minimum radial loads to operate correctly. Roller bearings must only be used on belted loads. They are not suitable for direct-coupled loads. (Marathon Motors recommends that belting data is reviewed by Engineering prior to converting any motor to roller bearing.) This option includes replacing only the standard drive end bearing with a roller bearing and locking the opposite bearing axially. Available on TEFC Blue Chip® and Blue Chip®XRI® motors. Lead-time is 3 days.

### Roller to Ball Bearing

Larger horsepower motors are stocked standard with a roller bearing on the drive end. For direct-coupled applications, a ball bearing must be installed on the drive-end. Lead-time is 2 days.

### Sealed Bearing

This modification provides the option of replacing the standard bearings in AC motors with sealed bearings and replacing the grease fittings with plugs. May not be suitable for belted applications. 250 - 449 frame, 3600RPM, no sealed bearing option. 250 - 445, 1800RPM and below, non contact sealed only. 48 - 215, All RPM's are available for sealed bearings. Consult Marathon Motors for full application details. Call for lead-time.

### Insulated Bearing

Insulated bearings are used to reduce the transmission of shaft currents. In accordance with NEMA MG1-31.4.4.3, both bearings must be insulated to protect inverter-driven motors from inverter-sourced shaft voltages. The connected load must also be insulated from the motor shaft to prevent damage to it's bearings. Per UL, insulated bearings may **not** be installed in Division 1 or Division 2 hazardous locations. Division 2 will be removed from XRI®-Severe Duty and IEEE 841 motors when this modification is performed. Call for lead-time.

## Blowers - MOD19 (Mult. Symbol S4)

Low rotational speeds, common in many vector drive applications, cause additional heat within the motor. As a result, these motors are designed as TENV or TEBC. Marathon Motors offers two types of blower units, depending upon the application requirements. The axial blower is available on Marathon's XRI® and XRI®-Severe Duty.

### Axial Blower

Most TEBC requirements are satisfied with Marathon's axial blower. The blower motor and fan are in the same (horizontal) plane as the motor drive shaft. Lead-time is 3 days.

## C-Face Brackets - MOD2 (Mult. Symbol S4)

The addition of a C-Face kit to a standard foot mount (rigid base) motor, results in a non-NEMA "BA" dimension in 143-256 Frames due to NEMA's establishment of two distinct "BA" dimensions for each of the affected frame sizes: one for rigid base motors and another for C-Face/rigid base motors. No motor manufacturer can meet both prescribed dimensions on reworked motors. The following table identifies the "BA" dimensions (defined as the distance from the center of the front foot hole to the shaft shoulder) for 143T-256T and TC frames:

\* C-Face Kit (rework) "BA" dimension is identical to foot mount "BA."

NEMA FRAME	FOOT MOUNT*	C-FACE
143T-145T	2.38"	2.75"
182T-184T	2.75"	3.50"
213T-215T	3.50"	4.25"
254T-256T	4.25"	4.75"

## D-Flange Brackets - MOD17

### (Mult. Symbol S4)

Add a D-Flange Kit to rigid base, cast iron motor. Available on Blue Chip 254T-365T and Dripproof 284T-286T ("TTDP" and "TTDC" designs). Addition of D-Flange Kit results in non-NEMA 'BA' dimension or 254T-256T. Lead time is 2 days.

## IEC Brackets - MOD55 (Mult. Symbol S4)

### B14 FT Flange (IEC C-Face)

IEC mounting arrangement with the motor flange at the drive end similar to a NEMA C-Face motor. Modification includes motor disassembly and installation of a FT Flange to a Globetrotter® motor. Lead-time is 2 days.

### B5 FF Flange (IEC D-Flange)

IEC mounting arrangement with the motor flange at the drive end similar to a D-Flange. Modification includes motor disassembly and installation of a FF Flange to Globetrotter® motor. Lead-time is 2 days.

## Brake Motors - MOD3 (Mult. Symbol S4)

Spring-set, electrically released mechanical disc brakes are available for stopping and/or holding the load. Marathon's brakes are suitable for any angle mounting. Price of modification includes brake kit and installation.

# MOD CENTRAL - Motor Modifications

MOTOR HP	BRAKEMOTOR SHAFT R.P.M.		
	Lb-Ft @3600	Lb-Ft @1800	Lb-Ft @1200
1/4	---	---	3
1/3	---	3	3
1/2	3	3	3
3/4	3	6	6
1	3	6	6
1 1/2	6	10	10
2	6	10	---

## Brake Selection Chart

\*\* For normal (140%) torque rating, do not apply on motors larger than 2 HP. Reduced braking torque and /or longer stopping times can result from applying an undersized brake on higher HP motors.

## Brake Addition - TEFC

This modification includes the addition of a 3,6, or 10 Lb-Ft brake to single or three phase, TEFC, 56 (5000 series model numbers) and 143/145T Frame motors. Operating voltages are 115/208-230, 208-230/460, and 575 volts. Lead-time is 3 days.

## Brake Addition - Inverter Duty

This modification includes the addition of a 6 or 10 Lb-Ft brake to Marathon Motors's Black Max® or Blue Max® Vector Duty motors. Operating voltages are 115/208-230, 208-230/460, or 575 volts. Lead-time is 3 days.

## Brake Coil Voltage (Stearns only)

Brake coil changes allow for operation of brakes at various voltages on 50 or 60 Hertz AC power supplies. Available coil voltages at 50 HZ are 110, 220, 415, and 110/220 volts. Coil voltages at 60 HZ are 115, 200, 575, and 200/400 volts. Coil voltages at 60/50 HZ are 230/190, 460/380, and 208-230/460-190/380 volts. External brake coil lead connections will be brought out from the brake. Specify brake lead location, brake coil voltage, and supply frequency at time of order. Lead-time is 10 days.

MOD NUMBER	BRAKE RATING	BRAKE SERIES	LIST PRICE PER MOTOR
MOD3X	3 Ft/Lb	56,000	\$410
	6 Ft/Lb		
	10 Ft/Lb		
	15 Ft/Lb		
MOD3Y	25 Ft/Lb	87,000	\$510
	35 Ft/Lb		
	50 Ft/Lb		
	75 Ft/Lb		
	105 Ft/Lb		

## Vertical Modification Kit (Stearns 87,000 series)

Includes required hardware to accommodate vertical above (shaft down) or vertical below (shaft up) mounting.

TORQUE RATING (Lb/Ft)	MOUNTING	
	SHAFT UP	SHAFT DOWN
25,35	Not req'd	Required
50,75,105	Required	Required

## Conduit Box - MOD56 (Mult. Symbol S4)

Standard conduit box construction is based on the individual product description, e.g. severe duty motors always have a cast iron conduit box, while some standard duty motors come with stamped steel and others cast iron. Conduit boxes meet or exceed NEC 430.12 requirements for volume.

Termination of protective or monitoring devices can be provided in a separate auxiliary conduit box or conduit. Auxiliary conduit boxes are not available on explosion proof motors.

## Rotate Conduit Box Lead Opening

Standard motors have lead opening facing down toward motor base. Modifications include rotating the conduit box so the lead opening is facing the desired direction. Specify lead opening location facing conduit box. Available on non-explosion proof motors. Lead-time is 2 days.

## Convert to Cast Iron

Replacement of steel conduit box with a cast iron conduit box. This modification is available on non-explosion proof cast iron motors as Marathon's explosion proof integral stock motors come standard with a cast iron conduit box. Lead-time is 2 days.

## Auxiliary Box (Condulet)

A condulet can be added to the main motor conduit box for routing of accessory leads. Available on ODP and TEFC (non-explosion proof) motors. Call for lead-time.

## Connections - MOD0 (Mult. Symbol S4)

Motor connections consist of special cords, plugs, and switches added to a single phase motor.

## Drains - MOD21 (Mult. Symbol S4)

Standard duty motors include a weep hole as standard, while severe duty and explosion proof motors include a brass drain/breather as standard. These are located in the drive end bracket at the lowest point.

## Condensation Drain Holes

Additional drilled holes will be made in both end brackets of TEFC motors. Not available on explosion proof motors. Lead-time is 2 days.

## Brass Drain & Breather

Combination self-draining and breather plugs are available on TEFC motors. Not available on explosion proof motors. Lead-time is 2 days.

## Stainless Steel Drain & Breather

Combination self-draining and breather plugs are available on TEFC motors. Not available on explosion proof motors. Lead-time is 2 days.

## Drip Covers - MOD4 (Mult. Symbol S4)

Drip covers can be furnished on standard motors for extra protection from dripping liquids and falling objects when the motor is mounted in the vertical shaft down position. These covers are recommended on all open dripproof and totally enclosed motors for vertical shaft down operation. These covers have no vertical lifting provisions provided.



# MOD CENTRAL - Motor Modifications

## Canopy Cover (ODP and TEFC Motors)

Modification includes installation of a sheet metal drip cover to the motor for vertical shaft down mounting. Available on rolled steel Dripproof motors through 256T frame and select TEFC motors. Lead-time is 2 days.

## Encoders - MOD22, and MOD24

(Mult. Symbol E3)

These electrical devices sense rotor speed and direction providing feedback to a control device. An encoder is a feedback device that translates mechanical motion into an electrical signal. A cable is connected from the encoder to the variable frequency drive to provide this feedback. Various mechanical provisions on the motor are required to attach the encoder. These may include C-Face on the non-drive end of the motor and special shaft extension. Various resolutions are available. All encoders offered have quadrature signal with line driver output.

Encoders can be mounted on Black Max® and Blue Max® 2000 Vector Duty motors, TENV 56 through 286T Frame, TEBC construction in 284T through 449T Frame.

## Stub Shaft - MOD42 (Mult. Symbol S4)

Add Stub Shaft to Fan Cooled XRI-SD, XRI-841 (182-449 Frames) to accommodate addition of encoder on opposite drive end of motor. Lead-time 2 days.

## Fan - MOD43, and MOD44 (Mult. Symbol S4)

Marathon Motors's XRI® Severe Duty and IEEE841 motors have non-sparking fans made with, high-temperature, reinforced corrosion resistant plastic that is impervious to chemical attack and has been specially designed for motor applications. All motors utilize bi-directional cooling fans.

## Oversized fan (Inverter Duty) -

See MOD43 Inverter Duty

## Fan Removal - MOD44

TEFC to TEAO. Convert a motor from totally enclosed, fan cooled construction to totally enclosed, air-over by removing fan cover, fan, and cutting off the fan end shaft. The modified motor must be mounted in the air stream of the driven fan for cooling purposes. The customer is responsible for providing adequate airflow over the motor. Lead-time is 2 days.

## Vane Axial Fan - MOD43

The modification can be done on rigid or C-Face mount, TEFC, TENV, EPFC, EPNV, or DP enclosures. Motors will be modified for Vane Axial fan applications. All motors will get an additional nameplate, and 42" extended leads. TEFC models will have the fan and fan guard removed and enclosure changed to TEAO. A minimum airstream velocity of 3000' per minute is required. Lead time is 4 days.

## Frequency - MOD7 (Mult. Symbol S4)

Most motors commonly operate on 60 hertz (HZ) within North America. However, 50 hertz systems are common in other countries.

## Frequency Re-Rate 60 HZ to 50 HZ

Marathon Motors's standard motors rated at 60 HZ may be operated at 50 HZ at reduced voltage and horsepower or Service Factor. A label containing specific re-rating information will be attached to the motor. Frame size is subject to change. Lead-time is 1 day.

## Grease/Fittings - MOD0, MOD15

(Mult. Symbol S4)

Standard grease is Exxon Polyrex® EM with a bearing operating temperature range of -30° to +150°C for ball and roller bearings. Devices for installing grease into the motors, such as zerk fittings, are available.

## Grease Relief Fittings - MOD15

Install standard grease relief fitting on motor. Grease relief fittings serve as an outlet to equalize pressure in the motor. Not available on explosion proof motors. Lead-time is 2 days.

## Zerk Fittings (Cast Iron Motors) - MOD15

Replace standard grease plugs on motors with zerk fittings. XRI® Severe Duty and IEEE841 motors come with zerk fittings as standard equipment. Not available on explosion proof motors. Lead-time is 2 days.

## Low Temperature Grease - MOD0

Bearing grease may be changed to allow for a lower operation range. The motor bearings and end bells are purged and repacked with Beacon 325 grease or equivalent with a grease temperature range of -60°C to +120°C. Call for lead-time.

## High Temperature Grease - MOD0

Bearing grease may be changed to allow for a higher operating range. The motor bearings and end bells are purged and repacked with Dow Corning DC44M grease or equivalent with a grease temperature range of -40° to +204°C. Call for lead-time.

## Grounding - MOD20 (Mult. Symbol S4)

All motors 48 to 449T Frame have grounding provisions per NEMA and NEC Standards. Explosion proof motors are permitted to have a frame ground, but electrical ground in conduit box must also be connected.

## Conduit Box Grounding Lug

Add clamp-type grounding lug in the conduit box. Lead-time is 2 days.

## On-Frame Grounding (Cast Iron Motors)

Addition of drilled and tapped hole on conduit box side of frame with installation of grounding lug. Available on non-explosion proof cast iron ratings only. Lead-time is 2 days.

## Shaft Grounding Ring

Shaft grounding rings are recommended (NEMA MG1 31.4.4.3) as an effective means of bearing protection for motors operated from inverter power. One ring is adequate to bleed down inverter-sourced shaft voltages, thereby protecting both bearings for motors as large as 5011 frame. May not be installed on motors used in Division 1 or Division 2 hazardous locations or motors with a modified shaft. Does not fit all motor types. Contact factory for lead-time.

## Inverter Duty - MOD25, MOD26, and MOD43

(Mult. Symbol S4)

"Inverter Duty" describes a class of motors that are capable of operation from a variable frequency drive. Many Marathon general purpose motors are suitable for most variable torque and some limited constant torque applications.

These motors do not have provisions for mounting encoders, but are suitable for use with volts/hertz or open loop vector controls. As required under Federal law, these motors comply with EPA efficiency requirements when operating from utility power.

# MOD CENTRAL - Motor Modifications

## INV. DUTY (LEADTIME 2 DAYS)

Mod #	Appl.	Mtr. Type	Mod
25	Variable Torque	Any	Add thermostats, re-nameplate
26	10:1 CT	EPAct TEFC	Oversized fan, Add thermostats, re-nameplate
	20:1 CT	NEMA Premium® TEFC	
43	10:1 CT	EPAct TEFC	Oversized fan, re-nameplate
	20:1 CT	NEMA Premium® TEFC	

Operation of motor on VFD exempts motor from Epact mandated efficiency levels.

**Leads - MOD0, MOD9, and MOD33,**  
(Mult. Symbol S4)

All motors are provided with standard leads of ample length for easy connection in the conduit box to the power leads. Lead size and material are dependent upon the class of insulation system in the motor and the current capacity required.

### Reconnection - MOD9

Reconnect dual voltage 9-lead or 12-lead motors to a 3-lead single voltage. Connection is made inside the motor frame. Specify desired voltage when ordering. On single phase motors, specify rotation. Lead-time is 2 days.

\*Part Winding Start and Star-delta connections are excluded.

### Remark Leads - MOD33

Using cloth markers, remark leads with numbers or letters. Please specify markings. Lead-time is 2 days.

### Longer Leads - MOD0

Extend leads up to two feet longer than standard by splicing. Splice will be visible in conduit box. Not available on explosion proof motors. Lead-time is 2 days.

### Mounting/Assembly - MOD1, and MOD39

  
(Mult. Symbol S4)

Motors listed are horizontal, foot mounted. Many stock motors can be furnished in assembly positions as illustrated. Modification may include repositioning of vents, baffles, drains, and conduit box. Also end brackets are assembled and grease fittings are properly installed for operation with the motor in the position shown. No attempt is made to locate fittings on any particular side of the motor. Horizontal ball bearing motor assemblies W5, W6, W7, and W8 are not suitable for external thrusts in excess of rotor weight and half-coupling. Cast Iron ODP and TEFC, 360 and larger, are not suitable for vertical operation. Consult Engineering for TEFC Build Up. Lead-time is 2 days.

### Convert to Floor, Ceiling, or Wall Mount - MOD1

Convert standard F1 mount to F2, W1, W2, W3, W4, W5, W6, W7, W8, C1, or C2 mount. The mounting symbol is required when ordering to indicate the proper mounting. Lead-time is 2 days.

Example: Motor will be modified F1 to wall mounting W3.

### FLOOR MOUNTING ASSEMBLIES

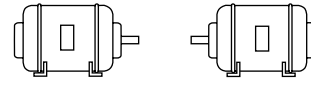

F-1

F-2

### CEILING MOUNTING ASSEMBLIES

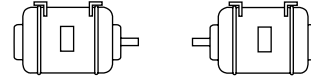

C-1

C-2

### WALL MOUNTING ASSEMBLIES

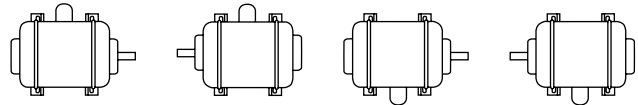

W-1

W-2

W-3

W-4

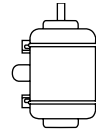

W-5

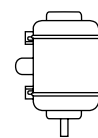

W-6

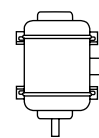

W-7

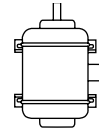

W-8

### Adjustable Motor Bases - MOD39

Adjustable bases are a convenient means for adjusting belt tension or may be used as mounting plates. Adjustable motor bases are bolted to fixed base of motor prior to shipping. NEMA 215T and smaller bases feature one adjusting screw. Bases on NEMA 254T and larger feature two adjusting screws. Bases are not suitable for vertical mounting. Lead-time is 2 days.

### Nameplates / Markings - MOD7

  
(Mult. Symbol S4)

Nameplate material is mylar or stainless steel depending on motor design and enclosure.

### Additional Data on Nameplate

Motors can be re-nameplated for alternate ratings. Changes in horsepower, altitude, ambient, voltage, frequency, etc. Lead-time is 1 day.

### CE Mark

CE compliant mark can be provided for all non explosion proof NEMA frame motors. Many stock motors already contain the CE mark. Lead-time is 2 days.

# MOD CENTRAL - Motor Modifications

## Rotation Arrow

All motors utilize bi-directional cooling fans. Specify rotation facing shaft extension on order entry form. Available on Single Phase only. Lead-time is 1 day.

## Stainless Steel Nameplate

Replace existing mylar nameplate with 304 stainless steel nameplate. Lead-time is 1 day.

## Separate Nameplate for Customer Data

A separate customer nameplate can be furnished. Information contained must be submitted at time of order. These additional nameplates cannot be supplied with CSA or UL Listings unless installed to motor in a Marathon Motors facility. Lead-time is 2 days.

## Packaging - MOD29 (Mult. Symbol S4)

### Heat Treated Pallets

ISPM-15 requires the use of heat-treated wooden packaging materials when shipping into all foreign countries (a temporary exemption exists for Canada). Modification includes replacement of wooden pallet with heat-treated pallet. Does not include export crating for ocean freight (contact factory for export packaging cost).

## Paint - MOD8 (Mult. Symbol S4)

The standard paint finish is a two-coat paint system. The first coat is a rust-inhibitive primer applied to protect the castings during storage and manufacturing. The second coat is a powder coat on 48-140 frame, enamel on non-severe duty motors, or a 2-part epoxy on severe duty 180-5000 frame motors.

Special paints and color options are available if compatible and reviewed by application engineering. Paint chips and material safety data sheets are required.

## Repaint to a Marathon Stock Color

Repaint motor to another Marathon Motors stock paint color. Colors include: Marathon Motors Blue Chip® blue, PowerWash™ white, farm duty black, Fire Pump red, light gray, or dark gray. Specify color on order. Leadtime on enamel paint is 2 days. Epoxy paint requires a 3 day lead-time.

## Screens - MOD0 (Mult. Symbol S4)

Corrosion resistant screens can be furnished over the air intake and discharge openings of cast iron dripproof motors. Dripproof motors equipped with these screens conform to the dripproof guarded definition appearing in NEMA MG-1, Part 1. Call for lead time.

## Service Factor - MOD7 (Mult. Symbol S4)

A multiplier that may be applied to the rated horsepower of a motor, which indicates a permissible horsepower loading at rated voltage and frequency. Lead-time is 1 day.

## AC Motor Service Factor Re-Rating

When a 1.15 Service Factor or higher is required, please refer to the list adder. Frame size is subject to change. Not available on explosion proof motors. Lead-time is 1 day.

## Severe Duty Construction - MOD16

(Mult. Symbol S4)

This modification starts with a Marathon Blue Chip® Totally Enclosed cast iron frame motor and reworks it to all cast iron construction. With additional enhancements, the motor is prepared for a severe or harsh industrial environment. (Domestic Built Product Only)

Remove polypropylene fan cover and sheet metal conduit box from the motor and replace with cast iron fan cover, threaded and gasketed conduit box, apply epoxy finish to motor exterior, and add brass drain and breather.

Lead-time is 2 days.

## Shaft Modification - MOD0, and MOD42

(Mult. Symbol S4)

Motors are furnished with a single straight shaft with sled runner keyway and a rectangular key. For motors in frames 143T through 449T, a long shaft for V-Belt drive is supplied. 2-Pole motors in frames 324 through 449 and certain other 4-Pole ratings are furnished with short shafts for direct connections. Modifications are for existing shafts only. Not applicable if a new shaft is required.

Call for lead-time.

## Drill & Tap Hole - MOD42

Drilled radially or in the end of the shaft. Drilled and tapped in the end of the shaft.

Lead-time is 3 days.

## TS Shaft - MOD42

Convert "T" frame shaft to a "TS" Frame shaft. Modify motor by reducing the shaft, adding new keyway, and shortening the shaft length to the NEMA "TS" dimension.

Lead-time is 2 days.

## Mill Flat on Shaft - MOD0

Mill a flat on the drive end shaft extension. Provide detail of flat with the order.

Lead-time is 2 days.

## Steps on Shaft - MOD0

One to three reductions in shaft diameter. Customer to specify number of reductions at time of order.

Call for lead time.

# MOD CENTRAL - Motor Modifications

## Space Heaters - MOD12, and MOD41

(Mult. Symbol S4)

Space heaters are used to prevent the build-up of condensation on the windings of the motor when the motor is not operating. Space heaters are typically installed on the end-turns of the coils.

## Space Heaters - ODP & TEFC - MOD12

Space heaters can be furnished on dripproof and totally enclosed motors. Heater leads are normally brought out to the motor conduit box. Heater voltage is available in three voltages for 60 Hz operation of 115, 230, or 460 volt, single-phase. Space heaters are sized per NEMA standards.

Lead-time is 2 days.

## Space Heaters - IEC Frames - MOD12

Space heaters can be furnished on IEC motors. Heater leads are normally brought out to the main terminal box. Heater voltage is available in two voltages for 50 Hz operation.

Lead-time is 2 days.

## Space Heaters - Explosion Proof - MOD41

Space heaters can be furnished on explosion proof motors. Heater leads are normally brought out to the motor conduit box. Heater voltage is available in three voltages for 60 Hz operation of 115, 230, or 460 volt, single-phase. Space heaters are sized per NEMA standards.

Lead-time is 2 days.

**Terminal Blocks - MOD0 (Mult. Symbol S4)** Conduit box mounted terminal blocks provide for a convenient termination of power leads. The terminal blocks are sized for the proper amperage and voltage of the motor. The Globetrotter® IEC motor has IEC terminal blocks as standard.

## Terminal Block

Install terminal blocks in conduit box of NEMA motor with lead connection. Customer to advise on lead connection. Call for lead-time. Contact factory to verify capability.

## Thermal Protection - MOD0, and MOD14

(Mult. Symbol S4)

Thermal protection are built in protective devices that prevent motor overheating. They work either by interrupting the power supply when the motor overheats or by incorporating a pilot device that opens the holding circuit of a magnetic starter or energizes an alarm bell or warning light.

## Thermostats - All Motors - MOD14

Thermostats are mounted on the stator winding and are temperature-sensing only, with normally closed snap action contacts. These devices are installed on the end-turns of the motor winding. Their purpose is to activate a warning device or shut down the motor upon excessive winding temperatures. The standard arrangement is the addition of 2 or 3 thermostats to the winding end-turns, connected in series with the leads brought out to the main motor conduit box. Class I Groups C & D / Class II Groups F & G Explosion Proof motors have hermetically sealed thermostats as standard.

Lead-time is 2 days.

## Thermistors - All Motors - MOD14

Thermistors are small, non-linear resistance devices placed on the stator windings. As the critical temperature is reached, the resistance of the thermistor changes radically, causing operation of a control relay. The standard arrangement is Q-3 positive temperature coefficient (PTC) type on winding end-turns with leads brought out to the main motor conduit box. On IEC motors the leads are brought into a conduit adjacent to the main conduit box and includes a terminal block. As standard, 3 Texas Instrument thermistors are furnished, one per phase. Control Module is available.

Lead-time is 2 days.

## Thermocouples - Non XP Motors - MOD0

Thermocouples sense temperature and offer inherent protection against abnormal stall and running conditions. The standard arrangement is the addition of an iron constantan thermocouple to the winding end turns or bearing housing with leads brought out to the main motor conduit box. Customer must specify number, type, and location at time of order.

Lead-time is 2 days.

## Weatherproofing/Special Service

MOD5, and MOD49

(Mult. Symbol S4)

Weatherproofing or special service provides additional protection to windings and mechanical parts as well as special greases or modifications per industry specifications such as NEMA, or IEEE. Call for lead-time.

## Tropical Anti-Fungus Treatment - MOD5

Windings and mechanical parts coated with polyurethane for superior protection to resist tropical environments. Not available on brake motors.

Lead-time is 2 days.

## Hazardous Duty™ Service

Division 2 Hazardous Motors - MOD49

The Division 2 hazardous modification incorporates a new fan, fan guard, and nameplate on most TEFC motors. XRI®-SD and IEEE841 motors have Division 2 statement on the nameplate as standard. The nameplate will say "CSA Certified, Group I, Division 2, Groups A, B, C, and D, Temperature Code.

(See chart below) Call for lead-time.

NEMA FRAME	SERVICE FACTOR	POWER SUPPLY	FREQUENCY RANGE	TEMP CODE
56-449T	1.0	SineWave	50-60Hz	T3
56-449T	1.0	PWM	3-120Hz	T2D
56-449T	1.15	SineWave	60Hz	T2B

# Accessory Kits - Index

DESCRIPTION	PAGE NUMBER
<b>Bases</b>	
• Adjustable Motor Bases	219
• Transition Bases	219
<b>Bearings</b>	
• Ball Bearing Conversion Kits	216
• Roller Bearing Conversion Kits	216
<b>Blower</b>	
• Axial Blower Kits	216
<b>Bracket</b>	
• C-Face Kits - Dripproof	205
• C-Face Kits - NEMA Premium / Globetrotter Dripproof	205
• C-Face Kits - Totally Enclosed	206
• C-Face Kits - XRI® IEEE 841	207
• D-Flange Kits	207
• FF (B5) Flange (IEC D-Flange)	208
• FT (B14) Flange (IEC C-Face)	208
• Metric Flanges to Reduce Diameter	208
<b>Brakes</b>	
• Brake Kits - Single and Three Phase	209
• Brake Kits - Inverter Duty (Black Max® and Blue Max®)	209
• Double C-Face Coupler Brake	209
• Vertical Modification Kit	209
<b>Capacitor Kits</b>	
• Capacitor Mounting Kit	212
• Capacitor with Mounting Kit	212
• Oval Run Capacitors	212
• Capacitor Selection Guide	213
<b>Conduit Box</b>	
• Cast Iron Conduit Box Kits	214
<b>Drip Covers</b>	
• Motor Rainshield/Fan Canopy	214
• Drip Cover Kits (48-256T Frame)	214
<b>Encoders, Cables, and Stub Shaft</b>	
• Avtron - Black Max® / Blue Max®	217
• BEI - Black Max® / Blue Max®	217
• Dynapar - Black Max® / Blue Max®	217
• EPC - Black Max® / Blue Max®	217
• Northstar - Black Max® / Blue Max®	217
• Turck - Black Max® / Blue Max®	217
• Danaher Controls (Cable Kits)	217
• Encoder Stub Shaft Kit (XRI®-SD & XRI®-841, TEFC only)	217

# Accessory Kits - Index

DESCRIPTION	PAGE NUMBER
<b>Explosion Proof</b>	
• Explosion Proof Conduit box -----	214
• Lead Exit Reducer -----	214
<b>Grounding</b>	
• AEGIS - Shaft Grounding Ring Kits -----	218
• Conductive Epoxy -----	218
• Replacement Ground Brush Parts -----	218
<b>Mounting</b>	
• 48 Frame Lug Mount Kits -----	211
• Fedders Adapter Plate -----	212
• Fedders Mounting Kit -----	212
• Length Adapter Kit -----	212
• Resilient Base Latches -----	211
• Resilient Base (includes latches) -----	210
• Resilient Mounting Kit -----	210
• Resilient Ring Kit -----	210
• Rheem/Ruud Mounting Kit -----	212
• Rubber Mounting Hardware -----	211
• Split Mounting Rings -----	211
<b>5K Motor Accessories</b>	
• Base Plates -----	215
• Bearings -----	215
• C-Face Endsheids -----	215
• Capacitors -----	215
• imPower Signal Cord -----	215
• ODE Endsheids -----	215
• Square Flange Endsheids -----	215
• Start Mechanisms -----	215
• Switches -----	215
• Voltage Change Plug -----	215
• Pump Motor Rainshield Kit -----	215
<b>Severe Duty Construction (Upgrade Kits)</b>	
• Cast Iron Fan Cover and Conduit Box Kits -----	216
<b>Shaft Kits</b>	
• Blower Wheel Remover -----	213
• Brass Punch -----	214
• Encoder Stub Shaft Kit (XRI®-SD & XRI®-841, TEFC only) -----	217
• Shaft Adapter Sleeve -----	213
• Shaft Lock Device -----	213
• Tapered Fork -----	213
<b>Switches</b>	
• Toggle Switches -----	213
<b>Terminal Block Kits</b>	
• Terminal Block Kits - 182 to 449 Frames -----	208

## Accessory Kits - Multiplier Symbol S4



Complete kits with hardware necessary for converting Marathon stock rigid base motors to "C-Face" mounting with rigid base.

Excludes Blue Chip® XRI® Dripproof stock motors, see below

### C-Face Kits - Dripproof (Standard and EPAct Efficiency)

CAT. NO.	FRAME	KIT NO.	LIST PRICE	WHERE USED (Models Containing)	WEIGHT	FOOT NOTES
A435	56	KIT 56CDR-1	\$37	A 6203 (17mm) bearing	3	
AG212	56	161L185AAG1	\$37	A 6203 bearing (5K Type, 30 Frame)	3	
A534	56	161L187BAG1	\$37	A 6203 bearing (5K Type, 40 Frame)	3	
A436	56-143T-145T	KIT 140TCDR-1	\$69	A 6205 (25mm) bearing	3	75
A535	143T-145T	161L187BCG1	\$69	A 6205 bearing (5K Type, 40 Frame)	3	75
A666	182T-184T	KIT 175691	\$102	TTDW, TBDW, or TCDW	14	75
A606	213T-215T	KIT 210TCDW	\$143	TTDW, TBDW, or TCDW	13	75
A612	254T-256T	KIT 250TCDX	\$165	TTDX	13	75
A610	284T-286T/T	KIT 280TCDP	\$306	TTDP or TSTDP	30	75
A287	284T-286T/T	KIT 280TCD	\$306	TTDC/N	38	75
A1287	284T-286T/T	KIT 280TCDCA	\$306	TTDCA	45	75
A613	324T-326T/T	KIT 320TCDP	\$530	TTDC/P or TSTDC/P	43	
A216	364T-365T	KIT 360TCDS	\$673	TTDC/S	71	
A219	364TS-365TS	KIT 360TSCDS	\$673	TSTDC/S	62	
A222	404T-405T	KIT 400TCDS	\$736	TTDS	82	
A225	404TS-405TS	KIT 400TSCDS	\$736	TSTDS	89	
A228	444T-445T	KIT 440TCDS	\$1,408	TTDS	116	
A231	444TS-445TS	KIT 440TSCDS	\$1,408	TSTDS	119	
A293	447TS/449TS	KIT 440TSCDN	\$1,408	TSTDN	144	

### C-Face Kits - XRI Blue Chip® NEMA Premium and Globetrotter Dripproof

CAT. NO.	FRAME	KIT NO.	LIST PRICE	WHERE USED (Models Containing)	WEIGHT	FOOT NOTES
A600	143T-145T	KIT 175181	\$69	U244, U245, U246, U265, U758, U759, and U760	5	75
A436	143T-145T	KIT 140TCDR-1	\$69	E927, E928, and E929	3	75
A160	182T-184T	KIT 180TCD-WD	\$102	TTDB (2,4 and 6 pole)	14	75
A602	213T-215T	KIT 175066	\$143	U268, U269, U763, U764, U765, and U766	18	75
A161	213T-215T	KIT 210TCD-WD	\$143	TTDB (2,4 and 6 pole)	22	75
A622	254T-256T	KIT 175067	\$165	U254, U255, U767, U768, U769, and U770	27	75
A162	254T-256T	KIT 250TCD2-WD	\$165	TTDCA (2 pole only)	32	75
A163	254T-256T	KIT 250TCD-WD	\$165	TTDCA (4 and 6 pole only)	32	75
A626	284T-286T	KIT 175058	\$306	U256, U257, U771, U772, U773, and U774	32	75
A164	284TS-286TS	KIT 280TCD2-WD	\$306	TSTDCA (2 pole only)	38	75
A165	284T-286T	KIT 280TCD-WD	\$306	TTDCA (4 and 6 pole only)	38	75
A627	324T-326T	KIT 175059	\$530	U775, U776, U777, U778, U798 and U799	39	
A166	324TS-326TS	KIT 320TCD2-WD	\$530	TSTDCA (2 pole only)	45	
A167	324T-326T	KIT 320TCD-WD	\$530	TTDCA (4 and 6 pole only)	45	
A628	364T-365T	KIT 175060	\$673	U779, U782, U783, U784, U927, and U928	56	
A629	364T-365T	KIT 175601	\$673	U1779, U1782, U1783, U1784, U1927, and U1928	56	
A216	364T-365T	KIT 360TCDS	\$673	E921	71	
A168	364TS-365TS	KIT 360TCD2-WD	\$673	TSTDCB (2 pole only)	85	
A169	364T-365T	KIT 360TCD-WD	\$673	TTDCB (4 and 6 pole only)	85	
A222	404T-405T	KIT 400TCDS	\$736	E922, E923, U270, and U271	82	
A225	404TS-405TS	KIT 400TSCDS	\$736	U250 and U251	89	
A414	404TS-405TS	KIT 400TCD2-WD	\$736	TSTDC (2 pole only)	95	
A415	404T-405T	KIT 400TCD-WD	\$736	TTDC (4 and 6 pole only)	95	
A228	444T-445T	KIT 440TCDS	\$1,408	U272, U273, E924, E925 and E926	116	
A416	444TS-445TS	KIT 444/5TCD2-WD	\$1,408	TSTDC (2 pole only)	140	
A417	444T-445T	KIT 444/5TCD-WD	\$1,408	TTDC (4 and 6 pole only)	140	
A419	447T-449T	KIT 447/9TCD-WD	\$1,408	TTDC (6 pole only)	140	

All Kits Listed on This Page are Stock

# Accessory Kits - Multiplier Symbol S4



Complete kits with hardware necessary for converting Marathon stock rigid base motors to "C-Face" mounting with rigid base. Includes Globetrotter, XRI (AS NOTED), and Severe Duty.

Excludes Blue Chip® XRI® IEEE-841 stock motors, available on the next page.

## C-Face Kits - Totally Enclosed

CAT. NO.	FRAME	KIT NO.	LIST PRICE	WHERE USED (Models Containing)	WEIGHT	FOOT NOTES
A437	56	KIT 56CFR-1	\$37	A 6203 (17mm) bearing (standard frame)	3	
AG215	56	161L186AAG1	\$37	A 6203 bearing (5K Type, 30 Frame)	3	
A536	56	161L188BAG1	\$37	A 6203 bearing (5K Type, 40 Frame)	3	
A438	56-143T-145T	KIT 140TCFR-1	\$69	A 6205 (25mm) bearing or TBFR, TCFR, TTTR, or TTFR	5	75
A537	140T	161L188BCG1	\$69	A 6205 bearing (5K Type, 40 Frame)	5	75
A603	143T	KIT 143TCFN	\$69	TTFN, TTTC, or TTTN	5	75,76
A642	56-143T-140T	KIT 175077	\$69	Use on 56-140 frame XRI-NEMA Premium rolled steel models	5	75
A655	145T	KIT 145TCFN	\$69	TTFN, TTTC, or TTTN	5	75,76
A170	182T-184T	KIT 180TCF-WD	\$102	TTFBA (GLOBETROTTER)	14	75
A640	182T-184T	KIT 180TCN4.5	\$102	TTFN (Non-Std. 4-1/2" ak dim)	14	75
A641	182T-184T	KIT 180TCN8.5	\$102	TTFN (8-1/2" AK)	14	75
A643	182T-184T	KIT 175296	\$102	Use on model numbers 182/4TTFR4026 (8-1/2"AK)	14	75
A644	182T-184T	KIT 180CF8.5-1	\$102	TTTL/S, TCFL/R, TTFC (Not XRI)/L/R/S or THTS (Standard 8-1/2" AK dim.)	14	75
A645	182T-184T	KIT 180CF4.5-1	\$102	TTFC (Not XRI)/L/R/S (Non-Std. 4-1/2" AK dim.)	14	75
A666	182T-184T	KIT 175691	\$102	TCFW, TBFW, TTFW	14	75
A171	213T-215T	KIT 210TCF-WD	\$143	TTFBA (GLOBETROTTER)	22	75
A204	213T-215T	KIT 210TCFL	\$143	TTFL/R or TBFL	17	75
A206	213T-215T	KIT 210TCFS	\$143	TTFC (Not XRI)/S, THFS, TTTS and THTS (except 213/5TTFC4075)	17	75
A609	213T-215T	KIT 210TCFW	\$143	TBFW, TTFW	17	75
A646	213T-215T	KIT 210TCN	\$143	TTFN	17	75
A652	213T-215T	KIT 175068	\$143	Use on models 213TTFC4076 and 215TTFC4076	17	75
A667	213T-215T	KIT 175844	\$143	XRI-NEMA Premium models containing TTFW1	17	75
A172	254T-256T	KIT 250TCF2-WD	\$165	TTFCA (2 pole only)(GLOBETROTTER)	32	75
A173	254T-256T	KIT 250TCF-WD	\$165	TTFCA (4 and 6 pole only)(GLOBETROTTER)	32	75
A209	254T-256T	KIT 250TCFL	\$165	TTFL, and THTL (254TTFL4076)	21	75
A1209	254T-256T	KIT 250TCFL-R	\$165	TTFL1 and THTL1 (current frame design) (254TTFL14076)	21	75
A284	254T-256T	KIT 250TCFNA	\$165	TTFNA, and THTNA	35	75
A239	254T-256T	KIT 250TCFPA	\$165	TTFPA, THTPA, and TSTFPA	35	75
A601	254T-256T	KIT 250TCFP	\$165	TTFC (Not XRI, or 254/6TTFC4076)	35	75
A653	254T-256T	KIT 175191	\$165	Use on model numbers 254TTFC4076 and 256TTFC4076	21	75
A174	284TS-286TS	KIT 280TCF2-WD	\$306	TSTFCA (2 pole only)(GLOBETROTTER)	38	
A611	284T-286T/TS	KIT 280TCFP	\$306	TTFC (Not XRI)/P, THFP, TSTFP or TSTFC (except 284/6TTFC4076)	31	
A615	284T-286T/TS	KIT 280TCFN	\$306	TTFN or TSTFN	52	
A617	284T-286T/TS	KIT 280TCFPA	\$306	TTFPA, THFPA, and TSTFPA	45	
A618	284T-286T/TS	KIT 280TCFNA	\$306	TTFNA, THFNA, or TSTFNA	55	
A654	284T-286T	KIT 175061	\$306	Use on model numbers 284TTFC4076 and 286TTFC4076	31	
A175	284T-286T	KIT 280TCF-WD	\$306	TTFC (4 and 6 pole)(GLOBETROTTER)	38	
A176	324TS-326TS	KIT 320TCF2-WD	\$530	TSTFCA (2 pole only)(GLOBETROTTER)	45	
A214	324T-326T/TS	KIT 320TCFS	\$530	TTFS, THFS, or TSTFS	90	
A614	324T-326T/TS	KIT 320TCFP	\$530	TTFC (Not XRI)/P, THFP, TSTFP or TSTFC (Not XRI)	50	
A619	324T-326T/TS	KIT 320TCFPA	\$530	TTFPA, THFPA, AND TSTFPA	57	
A177	324T-326T	KIT 320TCF-WD	\$530	TTFCA (4 and 6 pole only) (GLOBETROTTER)	45	
A178	364TS-365TS	KIT 360TCF2-WD	\$673	TSTFCA (2 pole only)(GLOBETROTTER)	85	
A396	364TS-365TS	KIT 360TSCFSR	\$673	TSTFS or TSHFS	105	
A217	364T-365T	KIT 360TCFS	\$673	TTFC (Not XRI)	105	
A179	364T-365T	KIT 360TCF-WD	\$673	TTFCA (4 and 6 pole only)(GLOBETROTTER)	85	
A395	364T-365T	KIT 360TCFSR	\$673	TTFS or THFS	105	
A226	404TS-405TS	KIT 400TSCFS	\$736	TSTFS or TSHFS	125	
A424	404TS-405TS	KIT 400TCF2-WD	\$736	TSTFC (2 pole only)(GLOBETROTTER)	175	
A223	404T-405T	KIT 400TCFS	\$736	TTFS or THFS	125	
A425	404T-405T	KIT 400TCF-WD	\$736	TTFC (4 and 6 pole only)(GLOBETROTTER)	175	
A232	444TS-445TS	KIT 440TSCFS	\$1,408	TSTFS or TSHFS	105	
A426	444TS-445TS	KIT 444/5TCF2-WD	\$1,408	TSTFC (2 pole only)(GLOBETROTTER)	225	
A621	444TS-445TS	KIT 440TSCFN	\$1,408	TSTFN or TSHFN	200	
A229	444T-445T	KIT 440TCFS	\$1,408	TTFS or THFS	175	
A427	444T-449T	KIT 444/5TCF-WD	\$1,408	TTFC (4 and 6 pole only)(GLOBETROTTER)	225	
A620	444T-445T	KIT 440TCFN	\$1,408	TTFN or THFN	205	
A428	447/9TS	KIT 447/9TCF2-WD	\$1,408	TSTFC (2 pole only)(GLOBETROTTER)	250	
A624	447/9TS	KIT 449TSCFS-1	\$1,408	TSTFS (6313 bearing), 2-Pole	200	
A625	447/9TS	KIT 449TSCFS-2	\$1,408	TSTFS (6318 bearing) 4-, 6-, and 8-Pole	200	
A623	447/9T	KIT 449TCFS	\$1,408	TTFS or THFS with ball bearings	200	

KITS AND ACCESSORIES

All Kits Listed on This Page are Stock



# Accessory Kits - Multiplier Symbol S4

Complete Kits with hardware and Inpro/Seal® necessary for converting Marathon stock IEEE-841 rigid base motors to “C-Face” mounting with rigid base.

## C-Face Kits - Blue Chip® XRI® IEEE-841 Motors

CAT. NO.	FRAME	KIT NO.	LIST PRICE	WHERE USED (Models Containing)	WEIGHT	FOOT NOTES
A181	143T	KIT 143TCTN - 841	\$146	THTN	9	75,76
A262	145T	KIT 145TCTN - 841	\$146	THTN	9	75,76
A182	182T - 184T	KIT 180TCFS - 841	\$206	THTS or THFS	13	75
A183	213T - 215T	KIT 210TCFS - 841	\$278	THTS or THFS	16	75
A184	254T - 256T	KIT 250TCFNA - 841	\$318	THFNA	35	75
A185	284T/TS-286T/TS	284T/TS-286T/TS	\$596	THFN	52	
A186	284T/TS-286T/TS	284T/TS-286T/TS	\$596	THFNA	52	
A187	324T/TS-326T/TS	324T/TS-326T/TS	\$978	THFS	89	
A188	364T - 365T	KIT 360TCFSR - 841	\$1,224	THFS	95	
A189	364TS - 365TS	KIT 360TSCFSR - 841	\$1,224	TSHFS	95	
A190	404T - 405T	KIT 400TCFS - 841	\$1,344	THFS	129	
A191	404TS-405TS	KIT 400TSCFS-841	\$1,344	TSHFS	118	
A192	444T - 445T	KIT 440TCFS - 841	\$1,869	THFS	175	
A193	444TS - 445TS	KIT 440TSCFS - 841	\$1,869	TSHFS	108	
A194	444T - 445T	KIT 440TCFN - 841	\$1,869	THFN	201	
A195	444TS - 445TS	KIT 440TSCFN - 841	\$1,869	TSHFN	199	

## D-Flange Kits

Complete kits with hardware necessary for converting Marathon **stock rigid base** motors to D-Flange mounting with rigid base.

CAT. NO.	FRAME	ENCLOSURE	KIT NO.	LIST PRICE	WHERE USED (Models Containing)	WEIGHT	FOOT NOTES
A647	254T-256T	TEFC	KIT 250TDFPA	\$407	TTFPA	21	97
A648	254T-256T	TEFC	KIT 250TDFNA	\$407	TTFNA	15	97
A649	254T-256T	TEFC	KIT 649R	\$407	TTFP or TTFC (EPAAct)	39	97
A650	284T/TS-286T/TS	DRIPPROOF	KIT 650R	\$715	TTDP,TTDC (EPAAct),TSTDPA or TSTDCA (EPAAct)	38	
A651	284T/TS-286T/TS	TEFC	KIT 651R	\$715	TTFP, TTFC (EPAAct), TSTFP or TSTFC (EPAAct)	38	
A656	284T-286T	TEFC	KIT 280TDFNA	\$715	TTFNA	60	97
A658	324T/TS-326T/TS	TEFC	KIT 320TDFS	\$808	TTFS, TSTFS	118	
A657	324T-326T	TEFC	KIT 320TDFPA	\$808	TTFPA or TSTFPA	83	97
A637	364T-365T	TEFC	KIT 360TDFC	\$954	TTFC (EPAAct)	121	

Complete kits with hardware necessary for converting Marathon **stock C-Face rigid base** motors to D-Flange mounting with rigid base.

CAT. NO.	FRAME	ENCLOSURE	KIT NO.	LIST PRICE	WHERE USED (Models Containing)	WEIGHT
A630	182TC-184TC	TEFC	KIT 180TDFR	\$160	TTFR	17
A631	284TC-286TC	TEFC	KIT 280TDFP	\$716	TTFP	15
A632	324TC-326TC	TEFC	KIT 320TDFP	\$876	TTFP	71
A634	405TC	TEFC	KIT 400TDFS	\$1,194	TTFS	149

All Kits Listed on This Page are Stock

# Accessory Kits - Multiplier Symbol S4

## IEC Mounting Kits

Complete kits with hardware necessary for converting Marathon IEC stock motors to B5 and B14 mountings.

### Flange Mounting Kits For Aluminum Frame Motors Only

FRAME	POLE	FLANGE	CAT. NO.	KIT NO.	LIST PRICE	BOLT CIRCLE "mm"	WEIGHT
63	ALL	FF/B5	A569	KIT 635115	\$53	115	15
	ALL	FT/B14	A561	KIT 631475	\$48	75	
71	ALL	FF/B5	A570	KIT 715130	\$62	130	15
	ALL	FT/B14	A562	KIT 711485	\$53	85	
80	ALL	FF/B5	A571	KIT 805165	\$67	165	25
	ALL	FT/B14	A563	KIT 8014100	\$59	100	
90	ALL	FF/B5	A572	KIT 905165	\$71	165	25
	ALL	FT/B14	A564	KIT 9014115	\$65	115	

### Flange Mounting Kits For Cast Iron Frame, EPAct (IE2) Motors Only

FRAME	FLANGE	CAT. NO.	KIT NO.	LIST PRICE	BOLT CIRCLE "mm"	WEIGHT	STYLE LETTER*
100	FF/B5	A573	KIT 1005215	\$94	215	16	None
		A554	KIT 175984	\$94	215	16	A
112	FT/B14	A565	KIT 10014130	\$86	130	10	None
		A581	KIT 175985	\$86	130	10	A
122	FF/B5	A574	KIT 1125215	\$101	215	33	None
		A555	KIT 175986	\$101	215	33	A
132	FT/B14	A566	KIT 11214130	\$94	130	13	None
		A582	KIT 175987	\$94	130	13	A
160	FF/B5	A575	KIT 1325265	\$134	265	20	None
		A556	KIT 175988	\$134	265	20	A
180	FT/B14	A567	KIT 13214165	\$125	165	16	None
		A583	KIT 175989	\$125	165	16	A
200	FF/B5	A576	KIT 1605300	\$254	300	33	None
		A557	KIT 175990	\$254	300	33	A
225	FT/B14	A568	KIT 16014215	\$245	215	30	None
		A584	KIT 175991	\$308	215	30	A
250	FF/B5	A577	KIT 1805300	\$315	300	33	None
		A558	KIT 175890	\$347	300	41	A
280	FF/B5	A578	KIT 2005350	\$411	350	45	None
		A559	KIT 175994	\$411	350	61	A
315	FF/B5	A579	KIT 2255400	\$526	400	60	None
		A580	KIT 175995	\$718	400	76	A

\*\* Style letter refers to the 8th position in the motor model number.  
Ex: 132STFCA4526

### Flange Mounting Kits For Cast Iron Frame, NEMA Premium (IE3) Motors Only

FRAME	POLE	FLANGE	CAT. NO.	KIT NO.	LIST PRICE	BOLT CIRCLE "mm"	WEIGHT
100	ALL	FF/B5	A554A	KIT 175810	\$94	215	16
		FT/B14	A581A	KIT 175817	\$86	130	10
112	2 & 4	FF/B5	A555B	KIT 175827	\$101	215	33
		FT/B14	A582B	KIT 175832	\$94	130	13
132	6	FF/B5	A554A	KIT 175810	\$94	215	33
		FT/B14	A581A	KIT 175817	\$86	130	13
160	2	FF/B5	A550	KIT 175828	\$134	265	20
		FT/B14	A589	KIT 175833	\$125	165	16
180	4 & 6	FF/B5	A556A	KIT 175812	\$134	265	20
		FT/B14	A583A	KIT 175819	\$125	165	16
200	2	FF/B5	A551	KIT 175829	\$254	300	33
		FT/B14	A590	KIT 175834	\$265	215	30
225	4 & 6	FF/B5	A557	KIT 175990	\$254	300	33
		FT/B14	A584	KIT 175991	\$265	215	30
250	2	FF/B5	A552	KIT 175830	\$347	300	41
		FF/B5	A558	KIT 175890	\$347	300	41
280	4 & 6	FF/B5	A553	KIT 175831	\$411	350	61
		FF/B5	A559	KIT 175994	\$411	350	61
315	ALL	FF/B5	A580	KIT 175995	\$718	400	76
250	ALL	FF/B5	A594	KIT 175835	\$921	400	165
280	ALL	FF/B5	A596	KIT 175836	\$1,152	500	201
315	ALL	FF/B5	A598	KIT 175837	\$1,454	600	232

### Metric Flanges To Reduce Diameter For Aluminum Frame Motors Only

MOTOR FRAME	NEW FRAME DIA.	CAT. NO.	KIT NO.	KIT ONLY LIST PRICE	WEIGHT
63	56	A585	KIT 175900	\$44	5
71	63	A586	KIT 175901	\$50	5
80	71	A587	KIT 175902	\$56	8
90	80	A588	KIT 175903	\$59	8

### Terminal Block Kits

Terminal blocks provide for a convenient termination for power leads, and are sized for the proper amperage and voltage of the motor. These kits fit domestically produced NEMA TEFC, TENV, and ODP motors equipped with cast iron conduit boxes. Available on 182 to 449 frames.

CAT. NO.	FRAME	KIT NO.	LIST PRICE	WEIGHT
A1000	180-210	KIT 180-210 TERM BLK	\$101	2
A1001	250-320	KIT 250-320 TERM BLK	\$123	3
A1002	360	KIT 360 TERM BLK	\$168	5
A1003	404-445	KIT 400-445 TERM BLK	\$168	7
A1004	447/449	KIT 447/9 TERM BLK	\$243	10



All Kits Listed on This Page are Stock

# Accessory Kits - Multiplier Symbol S4 (except as noted)

## Brake Kits - Single and Three Phase Motors

### Stearns 56000 Series Brake Kits

These kits include a brake mounted to an external cast aluminum fan guard. Designed for easy field installation on Marathon's Four-In-One motors, 56, 143 and 145 frames only.

Selection Chart  
(Used to select brake size)

MOTOR HP	BRAKEMOTOR SHAFT RPM		
	LB-FT @3600	LB-FT @1800	LB-FT @1200
1/4	—	—	3
1/3	—	3	3
1/2	3	3	3
3/4	3	6	6
1	3	6	6
1-1/2	6	10	10
2	6	10	—

TORQUE RATING (Lb-Ft)	LIST PRICE	115/208-230 VOLT		208-230/460 VOLT		575 VOLT		WEIGHT ALL
		CAT. NO.	KIT NO.	CAT. NO.	KIT NO.	CAT. NO.	KIT NO.	
3	\$398	A306	KIT 3BRK1	A301	KIT 3BRK3	A297	KIT 3BRK3A	10
6	\$469	A307	KIT 6BRK1	A302	KIT 6BRK3	A298	KIT 6BRK3A	11
10	\$580	-	-	A303	KIT 10BRK	A299	KIT 10BRKA	10

### Dings Brake Kits

These kits include a brake mounted to an external cast aluminum fan guard. Designed for easy field installation on Marathon's Four-In-One motors, 56, 143 and 145 frames only.

TORQUE RATING (Lb-Ft)	LIST PRICE	115/230 VOLT		208-230/460 VOLT		575 VOLT		WEIGHT ALL
		CAT. NO.	KIT NO.	CAT. NO.	KIT NO.	CAT. NO.	KIT NO.	
3	\$398	A1306	KIT BRK-3 115/230	A1301	KIT BRK-3 208-230/460	A1297	KIT BRK-3 575	3
6	\$469	A1307	KIT BRK-6 115/230	A1302	KIT BRK-6 208-230/460	A1298	KIT BRK-6 575	10
10	\$580	-	-	A1303	KIT BRK-10 208-230/460	A1299	KIT BRK-10 575	10

### Stearns 56000 Series Brake Kits - Inverter Duty TENV Black Max® and Blue Max® Motors - Multiplier Symbol E3

For normal (140%) torque rating, do not apply on motors larger than 2 HP. Reduced braking torque and/or longer stopping times can result from applying an undersized brake on higher HP motors.

These brake kits fit on both Black Max® and Blue Max® TENV motors (See pages 89 and 91). These can also be used together with the Double C-Face SL56 encoder to make a closed loop inverter brake motor.

TORQUE RATING (Lb-Ft)	LIST PRICE	115/208-230 VOLT		208-230/460 VOLT		575 VOLT		WEIGHT ALL
		CAT. NO.	KIT NO.	CAT. NO.	KIT NO.	CAT. NO.	KIT NO.	
6	\$715	A317	KIT BM6BRK115	A312	KIT BM6BRK	A315	KIT BM6BRK575	7
10	\$868	A318	KIT BM10BRK115	A313	KIT BM10BRK	A316	KIT BM10BRK575	7

See page 202 for encoder kits to install between the motor and brake.

### Vertical Modification Kit (Stearns 87,000 series)

Includes required hardware to accommodate vertical above (shaft down) or vertical below (shaft up) mounting.

TORQUE RATING (Lb/Ft)	MOUNTING		CAT. NO.	MODEL NO.	LIST (KITS ONLY)	WEIGHT
	SHAFT UP	SHAFT DOWN				
25,35	Not req'd	Required	A157	KIT VRT87BRK	\$420	3
50,75,105	Required	Required				

### Double C-Face Coupler Brakes

TORQUE RATING (Lb/Ft)	ENCLOSURE NEMA 2, IP-23 208-230/460V			ENCLOSURE NEMA 4, IP-54 208-230/460V			ENCLOSURE NEMA 4X, IP-55 208-230/460V			WEIGHT ALL
	CAT. NO.	KIT NO.	LIST PRICE	CAT. NO.	KIT NO.	LIST PRICE	CAT. NO.	KIT NO.	LIST PRICE	
3	A903	KIT 903	\$530	A906	KIT 906	\$652	A909	KIT 909	\$755	12
6	A904	KIT 904	\$591	A907	KIT 907	\$736	A910	KIT 910	\$816	12
10	A905	KIT 905	\$673	A908	KIT 908	\$816	A911	KIT 911	\$897	12



All Kits Listed on This Page are Stock

# Accessory Kits - Multiplier Symbol S4



## Resilient Base - (GE)

Includes base and latch straps.  
For use with motors having 2 1/4" resilient rings.

### NEMA 48 Frame, 2 1/4" Dia Rings

CAT. NO.	KIT NO.	LIST PRICE	SHELL LENGTH	FRAME SIZE	WEIGHT
AG109	161L113AAG1	\$31	5.16	32	5
AG110	161L113AAG2	\$31	5.41	33	5
AG111	161L113AAG3	\$31	5.79	35	5
AG112	161L113AAG4	\$31	6.22	36	5
AG113	161L113AAG5	\$31	6.62	37	5
AG114	161L113AAG6	\$31	7.22	38	5
AG115	161L113AAG9	\$31	7.75	39	5

### NEMA 56 Frame, 2 1/4" Dia Rings

CAT. NO.	KIT NO.	LIST PRICE	SHELL LENGTH	FRAME SIZE	WEIGHT
AG125	161L113ADG1	\$31	5.41	33	5
AG127	161L113ADG3	\$31	6.22	36, 49	5
AG128	161L113ADG4	\$31	6.62	37, 46	5
AG129	161L113ADG5	\$31	7.22	38, 49	5
AG130	161L113ADG14	\$31	7.75	39, 49	5

### 6 1/2" Dia Fan & Blower Replacement Motors

CAT. NO.	KIT NO.	LIST PRICE	SHELL LENGTH	FRAME SIZE	WEIGHT
AG125	161L113ADG1	\$31	P243, P245	42	5
AG127	161L113ADG3	\$31	P244, P246, P180	49	5
AG128	161L113ADG4	\$31	P184, P185	46	5



## Resilient Base - MEMC

Used to add a Resilient Base to models having Resilient Rings. Results in 3" shaft height. Kit includes: mounting base and 2 latch assemblies.

CAT. NO.	KIT NO.	LIST PRICE	RING TO RING DIMENSION	WEIGHT
A107	KIT 107-637	\$12	6.37"	2



## Resilient Mounting Kit

Used to add a resilient base to models having hubs only. 3-1/2" shaft height. Kit includes: mounting base, 2 resilient rings, 2 latch assemblies, 2 end caps and a slinger.

CAT. NO.	KIT NO.	LIST PRICE	USED WITH CAT. NO.	BASE LENGTH	WEIGHT
A279	KIT 279	\$21	X500	8-5/8"	5
A280	KIT 280	\$21	X501, X511, X208	9-1/8"	5
A281	KIT 281	\$47	X507, X509	11-5/8"	5
A282	KIT 282	\$41	X503	10-5/8"	5
A283	KIT 283	\$41	X502, X207	9-5/8"	5
A308	KIT 308	\$44	X206	10-1/8"	5

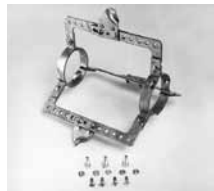

## Resilient Mount Kit

Fits 48 Frame motors with 2-1/2" diameter resilient rings. Available in 3 sizes to fit 9", 10" and 12" blowers.

CAT. NO.	KIT NO.	LIST PRICE	SIZE	WEIGHT
A240	KIT 240	\$40	9"	5
A241	KIT 241	\$60	12"	5
A242	KIT 242	\$49	10"	5

All Kits Listed on This Page are Stock

# Accessory Kits - Multiplier Symbol S4

## Split Mounting Rings

Used for adapting a 2-1/4" Resilient Mounting Ring to 2-1/2". Kit includes: 4 split rings.



CAT. NO.	KIT NO.	LIST PRICE	WEIGHT
A104	KIT 104	\$8	1

## Resilient Ring Kit

Used to mount Resilient Rings onto Hubbed PSC Brackets. Kit includes: 2 rubber resilient rings and 4 split rings.



CAT. NO.	KIT NO.	LIST PRICE	WEIGHT	NOTES
A110	KIT 110	\$11	1	2-1/4" (48 frame)
A114	KIT 114	\$16	1	2-1/2" (56 frame)

## Rubber Mounting Hardware

Used for mounting the resilient base to a resilient ring. Kit includes: 4 clamps, 2 screws, and 2 nuts.



CAT. NO.	KIT NO.	LIST PRICE	WEIGHT	NOTES
A112	KIT 112	\$10	1	56 Frame
A113	KIT 113	\$10	1	48 Frame
AG195	161L110AA1	\$10	1	2 1/2" dia; 30 or 40
A518	161L110AA4	\$10	1	2 1/2" dia; 40

## 48 Frame Lug Mounts Kits



**A249**  
Single Strap,  
Dual Slot  
2" L, 1/4" & 3/4" W  
\$35



**A250**  
Double Strap,  
Dual Slot  
2" L, 1/4" & 3/4" W  
\$35



**A251**  
Double Strap,  
Dual Slot  
4" L, 1/4" & 3/4" W  
\$35



**A252**  
Single Strap,  
Single Slot  
2" L x 3/8" W  
\$35



**A253**  
Double Strap,  
Single Slot  
2" L x 3/8" W  
\$35



**A254**  
Double Wire,  
Single Slot  
2" L x 3/8" W  
\$35

All Kits Listed on This Page are Stock

# Accessory Kits - Multiplier Symbol S4

## Length Adapter Kit



Used to convert Hubless motors to Resilient Ring mount. One adapter bracket can be mounted directly to original motor bracket and the other is mounted on the motor's thru-bolts and can be adjusted to desired length. Kit includes: 2 adapters, 2 resilient rings, 4 split rings, and the necessary nuts, screws, and washers.

## Rheem/Ruud Mounting Kit



Used to replace a Rheem/Ruud condenser fan motor where the original was held in place by four cables. Kit includes: prepunched plated steel plate, 4-8x32 nuts with washer fastened, 4-10x32 nuts with washers fastened and 4-1/4" sheet metal screws. Instructions included.

CAT. NO.	KIT NO.	DESCRIPTION	LIST PRICE	WEIGHT
A111	KIT 111	Two Adapters	\$20	1

CAT. NO.	KIT NO.	LIST PRICE	WEIGHT
A259	Kit 259	\$25	2

## Fedders Mounting Kit



Used in Fedders air conditioners.

CAT. NO.	KIT NO.	LIST PRICE	WEIGHT
A277	KIT 277	\$25	2

## Fedders Adapter Plate

Used to match Fedders rectangular mounting stud pattern on 5-5/8" motors.

CAT. NO.	KIT NO.	LIST PRICE	WEIGHT
A278	KIT 278	\$13	3

## Capacitor Mounting Kit



Used for mounting a capacitor on the frame of a Permanent Split Capacitor motors. Kit includes: mounting strap, mounting screws, and terminal protection boot. (4 screws are included - 2#10 screws and 2#8 screws). **Fits 10mfd. and smaller capacitors only.**

CAT. NO.	KIT NO.	LIST PRICE	WEIGHT
A100	KIT 100	\$8	2

## Capacitor with Mounting Kit

Kit includes 370 volt capacitor, mounting strap, mounting screws and terminal protection boot.

CAT. NO.	KIT NO.	SIZE	LIST PRICE	WEIGHT
A243	KIT 243	5.0 mfd	\$16	2
A244	KIT 244	7.5 mfd	\$19	2
A245	KIT 245	10.0 mfd	\$21	2

## Oval Run Capacitors



CAT. NO.	KIT NO.	SIZE	LIST PRICE	WEIGHT
A965	111A271P113	208mfd/110V	\$12	2
A371	KIT 370-3	3mfd/370v	\$9	2
A372	KIT 370-4	4mfd/370v	\$9	2
A373	KIT 370-5	5mfd/370v	\$9	2
A375	KIT 370-7.5	7.5mfd/370v	\$11	2
A376	KIT 370-10	10mfd/370v	\$11	2
A378	KIT 370-15	15mfd/370v	\$19	2
A379	KIT 370-17.5	17.5mfd/370v	\$19	2
A380	KIT 370-20	20mfd/370v	\$21	2
A381	KIT 370-25	25mfd/370v	\$24	2
A382	KIT 370-30	30mfd/370v	\$27	2
A445	KIT 440-7.5	7.5mfd/440v	\$17	2
A446	KIT 440-10	10mfd/440v	\$19	2
A447	KIT 440-12.5	12.5mfd/440v	\$27	2
A448	KIT 440-15	15mfd/440v	\$27	2
A449	KIT 440-17.5	17.5mfd/440v	\$19	2

All Kits Listed on This Page are Stock

# Accessory Kits - Multiplier Symbol S4

## Capacitor Selection Guide for Stock PSC Motors

370 VOLT													440 VOLT				
3.0 mfd	4.0 mfd	5.0 mfd				7.5 mfd		10.0 mfd		15.0 mfd	17.5 mfd	20.0 mfd	25.0 mfd	30.0 mfd	7.5 mfd	10.0 mfd	
X411	X223	X001	X048	X069	X210	X417	X000	X294	X004	X453	X009	X433	X206	X462	X271	X454	X237
X427	X273	X003	X049	X070	X212	X418	X002	X413	X010	X458	X016		X447	X449	X448	X446	X241
X429	X281	X006	X050	X080	X215	X419	X005	X415	X021	X1010	X023		X242		X405		
		X011	X052	X081	X216	X420	X013	X422	X033		X027						
		X012	X056	X082	X217	X423	X015	X424	X035		X036						
		X014	X057	X083	X219	X428	X018	X426	X038		X039						
		X017	X058	X086	X233	X430	X020	X450	X063		X085						
		X019	X059	X087	X234	X440	X022	X456	X068		X090						
		X034	X060	X088	X236	X441	X037	X457	X084		X099						
		X040	X061	X089	X258	X442	X071	X465	X096		X205						
		X041	X062	X097	X278	X443	X203		X098		X207						
		X042	X064	X200	X287	X445	X213		X208		X218						
		X043	X065	X202	X295	X463	X214		X211		X298						
		X044	X066	X204	X297	X464	X222		X221		X444						
		X045	X067	X209	X412	X262	X225		X400		X452						
		X033	X470				X231		X414		X455						
							X283		X416		X459						
									X451								

### Shaft Adapter Sleeve



Used to increase the diameter of a shaft to a larger size. Available sizes include converting from a 1/2" dia. shaft with flat to a 5/8" dia. with key and from a 5/8" dia. with key to a 3/4" dia. with key. Kit includes adapter sleeve and key.

CAT. NO.	KIT NO.	TO CHANGE SHAFT	LIST PRICE	WEIGHT
A105	KIT 105	1/2" to 5/8"	\$8	3
A106	KIT 106	5/8" to 3/4"	\$11	3

### Shaft Lock Device



Used as a pry point for prying the blade off. Instructions included.

CAT. NO.	KIT NO.	LIST PRICE	WEIGHT
A257	KIT 257	\$47	2

### Blower Wheel Remover



Used to pull off corroded, rusted, stubborn blower wheels from 5/8" diameter shafts and smaller. Comes with complete instructions.

CAT. NO.	KIT NO.	LIST PRICE	WEIGHT
A256	KIT 256	\$148	2

### Tapered Fork



Used for prying off pulleys, fan blades, etc., from any shaft 5/8" diameter or smaller. Long 16" handle gives good leverage. Instructions included.

CAT. NO.	KIT NO.	LIST PRICE	WEIGHT
A258	KIT 258	\$62	4

### Toggle Switch



Start switches for single-phase open dripproof motors only in ratings one horsepower and smaller. Switch is mounted on the motor terminal box cover.

CAT. NO.	KIT NO.	LIST PRICE	WEIGHT	NO. OF POLES	FRAME SIZE
AG228	112A515AKG4	\$37	2	Single (SPST)	30
AG229	112A515ASG2	\$37	2	Single (SPST)	40

All Kits Listed on This Page are Stock

# Accessory Kits - Multiplier Symbol S4 (except as noted)

## Brass Punch



Used for placing between your hammer and a motor's shaft or bearing. 3/4" diameter x 6" length.

CAT. NO.	KIT NO.	LIST PRICE	WEIGHT
A261	KIT 261	\$21	6

## Motor Rainshield/Fan Canopy

Sizes to fit 1/2" or 5/8" diameter shafts. 6.88" diameter. Shield has 8 air vanes to provide air circulation for motor. For vertical shaft up applications. Rain shield mounts over shaft.

### 056 Type Model Numbers



CAT. NO.	KIT NO.	LIST PRICE	WEIGHT	SHAFT DIA.
A247	KIT 247	\$8	2	1/2"
A248	KIT 248	\$8	2	5/8"

### 5K Type Model Numbers Includes clamp and black plastic cover.



CAT. NO.	KIT NO.	LIST PRICE	WEIGHT	WHERE USED
A549	52A101229AAG1	\$57	2	5.5" Dia. Motors, 1/2" shaft dia.

## Drip Cover Kits

Mounts with two screws into the end bracket. Kit includes: drip cover, mounting screws, washers, and instructions. Contact Marathon Motors to determine compatibility with motor. For vertical shaft down applications.

Note: Kit 234, the mounting holes have a 4.80 bolt circle.

CAT. NO.	FRAME	KIT NO.	ENCLOSURE	LIST PRICE	WEIGHT
A234	48-184T("629")	KIT 234	ODP OR TEFC	\$24	2
AG234	48-56	161L528AAG1	5K MDLS ODP	\$24	2
A201	182T-184T	KIT 201	ODP	\$27	3
A662	182T-184T	KIT 175614	ODP (TTDW)	\$62	15
A197	182T-184T	KIT 197	TEFC (4-IN-1)	\$27	3
A202	213T-215T	KIT 202	ODP (TTDR)	\$31	5
A198	213T-215T	KIT 198	ODP (TTDW)	\$31	5
A199	213T-215T	KIT 199	TEFC (4-IN-1)	\$31	5
A311	254T-256T	KIT 311	ODP (TTDX) Rigid Base	\$31	8

## Conduit Box Kit (56/140 Frame Explosion Proof Motors)

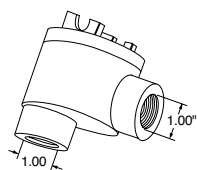

For installation on rolled steel 56/140 frame explosion proof motors. Lead exit holes are 1" dia. NPT.

CAT. NO.	KIT NO.	LIST PRICE	WEIGHT
A800	KIT 56 EXPR BOX	\$93	2

## Lead Exit Reducers (56/140 Frame Explosion Proof Motors)

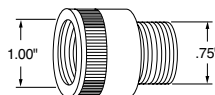

For reducing the lead exit from 1" to 3/4". Kit LDRDCR-M has an externally threaded 3/4" exit and internally threaded 1" exit.

CAT. NO.	KIT NO.	LIST PRICE	WEIGHT
A803	KIT LDRDCR-M	\$17	2

## Cast Iron Conduit Box Kits

Fits standard Blue Chip® motors. Threaded conduit box and gaskets.

CAT. NO.	FRAME	KIT NO.	LIST PRICE	WEIGHT
A720	182-215T	KIT 180/210CB	\$80	4
A722	254T-256T	KIT 250CB	\$132	12
A729	284T/TS-286T/TS	KIT 280CB	\$178	12
A730	324T/TS-326T/TS	KIT 320CB	\$198	28
A119	364T/TS-445T/TS	KIT 364-445CB	\$333	34

All Kits Listed on This Page are Stock



# Accessory Kits - Multiplier Symbol S4

## 5K Motor Accessories



CAT. NO.	KIT NO.	DISCRIPTION	LIST PRICE	WEIGHT
A000	KIT 391-200-01	15' Single cable kit	\$38	3
A940	KIT 391-200-02	25' Single cable kit	\$50	4
A940	52D310833AAP001	30 Frame C-face PE Endshield	\$21	4
A941	52D311808ARP1	40 Frame C-face PE Endshield	\$39	4
A942	52D310814AAP1	30 Frame OPE Endshield	\$15	4
A945	115D964P1	Base Plate for 30 Frame	\$8	2
A946	115D964P2	Base Plate for 40 Frame	\$8	2
A947	115D963P1	Back Compartment Cover	\$8	2
A948	113A617AG001	OPE bearing 17 mm	\$9	3
A949	113A620AYP1	PE bearing 20 mm	\$21	2
A950	976B399AAP9	Run Capacitor 15mfd/370v	\$24	2
A951	976B399AAP12	Run Capacitor 22.5mfd/370v	\$28	2
A952	976B399AAP13	Run Capacitor 25mfd/370v	\$29	2
A953	976B399ABP6	Run Capacitor 40mfd/370v	\$39	2
A954	976B399ABP9	Run Capacitor 45mfd/370v	\$35	2
A955	976B399ABP10	Run Capacitor 50mfd/370v	\$29	2
A956	161L198AAG9	Switch for Single Speed Models	\$9	1
A957	161L198AAG10	Switch for Two Speed Models	\$17	2
A958	161L197ABG1	Start mech for Single Speed Models	\$4	1
A959	161L197ABG11	Start mech for Two Speed Models	\$8	1
A960A	3062.09	Start Capacitor 161-193mfd/110v	\$12	2
A961	111A271P111	Start Capacitor 40mfd/220v	\$12	2
A962	52D310822ACDP1	30 Frame Square Flange PE Endshield	\$20	4
A963	52D311819ABP1	40 Frame Square Flange PE Endshield	\$39	4
A964	52A103486G1	Voltage Changing Plug	\$3	2

## Pump Motors Rainshield Kit

Designed for horizontally mounted pump motors to adhere to UL1081 standard. Includes screw and rain cover.



CAT. NO.	KIT NO.	WHERE USED	LIST PRICE	WEIGHT
AG697	161L210AAP1	5" & 5 1/2" Dia. Motors	\$57	1

All Kits Listed on This Page are Stock

# Accessory Kits - Multiplier Symbol S4

## Severe Duty - Upgrade to Cast Iron Fan Cover / Conduit Box

Fits standard Blue Chip® motors to achieve all cast iron construction. Components include fan guard and threaded conduit box.

CAT. NO.	KIT NO.	LIST PRICE	FRAME	WEIGHT	WHERE USED
A715	KIT 140CB	\$110	143T-145T	4	TTTN
A718	KIT 180R	\$158	182T-184T	17	THFN, THFS, THTS, TTFC (Not XRI), TTFN, TTFS, TTTS
A721	KIT 210R	\$230	213T-215T	19	THFS, THTS, TTFC (Not XRI), TTFS, TTTS
A723	KIT 250RFPA	\$279	254T-256T	32	TTFPA, or THFPA
A724	KIT 250RFNA	\$279	254T-256T	34	TTFNA, TTFCA (Not XRI), THTNA, or THFNA
A725	KIT 250R	\$279	254T-256T	32	TTFC (Not XRI)
A726	KIT 280RFPA	\$388	284T-286T	34	TTFPA, TSTFPA, or TSHFPA
A727	KIT 280RFN	\$388	284T-286T	39	TTFN or TSTFN
A728	KIT 280R	\$388	284T-286T	39	TTFC (Not XRI) or TTFF
A731	KIT 280RFNA	\$388	284T-286T	32	TTFNA, TSTFNA, THFNA or TSHFNA
A733	KIT 320RFPA	\$411	324T-326T	55	TTFPA, TSTFPA, THFPA, or TSHFPA

## Ball Bearing Conversion Kits

For conversion of Roller Bearing on Drive End to Ball Bearing (for Direct-coupled applications).

### CONFIRM KIT SELECTION WITH CUSTOMER SERVICE/ENGINEERING

CAT. NO.	KIT NO.	LIST PRICE	FRAME	BEARING SIZE	ENCLOSURE	WEIGHT	WHERE USED (Models Containing)
A760	KIT 440BBFN	\$1,530	444T-445T	318	TEFC	160	TTFN, THFN
A761	KIT 449BBFS	\$1,592	447T-449T	319	TEFC	171	TTFS, THFS
A788	KIT 449BBFS-319	\$1,592	L447T-L449T	319	TEFC	174	TTFS
A787	KIT 449BBFS-322	\$1,592	447T-449T	322	TEFC	196	TTFS
A795	KIT L449BBFS-322	\$1,592	L447T-L449T	322	TEFC	190	TTFS

## Roller Bearing Conversion Kits

For conversion of Ball Bearing on Drive End to Roller Bearing (for Belted Applications).

### CONFIRM KIT SELECTION WITH CUSTOMER SERVICE/ENGINEERING

CAT. NO.	KIT NO.	LIST PRICE	FRAME	ENCLOSURE	WEIGHT	WHERE USED (Models Containing)
A755	KIT 360BRFSR-314	\$1,164	364T-365T	TEFC	14	TTFS, THFS
A756	KIT 400BRFS-316	\$1,164	404T-405T	TEFC	19	TTFS, THFS
A757	KIT 440BRFS-318	\$1,530	444T-445T	TEFC	32	TTFS, THFS
A759	KIT 440BRFN	\$1,530	444T-445T	TEFC	13	TTFN, THFN
A758	KIT 449BRFS	\$1,592	447T-449T	TEFC & TEBC	20	TTFS, THFS

## Axial Blower Kits

For installation on Blue Chip XRI® Totally Enclosed and Severe Duty (excluding Explosion Proof).

CAT. NO.	KIT NO.	LIST PRICE	FRAME	WEIGHT	WHERE USED (Models Containing)
A692	KIT 21TEBC	\$1,606	213T-215T	104	TTFS
A691	KIT 25TEBCNA	\$1,755	254T-256T	158	TTFNA (Also fits 284/286T/TS TTFPA)
A701	KIT 28TEBCNA	\$2,066	284T/TS-286T/TS	103	TTFNA
A695	KIT 32TEBC	\$2,430	324T/TS-326T/TS	200	TTFS
A696	KIT 36TEBC	\$3,112	364T/TS-365T/TS	172	TTFS
A697	KIT 40TEBC	\$3,661	404T/TS-405T/TS	242	TTFS
A698	KIT 44TEBC-313	\$3,881	444TS-449TS	401	A 6313 bearing on opposite shaft end
A699	KIT 44TEBC-316	\$3,881	444T-449T	401	A 6316 bearing on opposite shaft end (excludes roller bearing)
A700	KIT 44TEBC-318	\$3,881	444T-449T	401	A 6318 bearing on opposite shaft end (excludes roller bearing)
A796	KIT L449TEBC	\$3,881	L447T-L449T	401	With L447/449 Frames

All Kits Listed on This Page are Stock

# Accessory Kits - Multiplier Symbol E3

## Encoder Kits and Accessories for Black Max®, Blue Max®, XRI®-SD and XRI®-841 motors

Installation of encoder kits on Blue Chip® XRI®-SD and XRI®-841 TEFC motors requires installation of A807 Stub Shaft Kit (see below)

ENCL.	FRAME	BRAND/ MODEL	PPR	CAT. NO.	KIT MO.	LIST PRICE	WEIGHT	NOTES		
TENV (5/8" bore)	56-286	Avtron HS25A	1024 2048	A746 A747	KIT HS25A1024-NV KIT HS25A2048-NV	\$1,064	4 4	Shaft Mount, 5-26 VDC, with 10 pin connector/mate		
		Avtron HS35A	1024	A736 A779A	KIT HS35A1024-NV KIT HS35A/B1024-NV	\$1,446	4 4	Shaft Mount, 5-26 VDC, with 10 pin connector/mate Shaft Mount, 5-26 VDC, with 10 pin connector/mate (REPLACES BEI A779)		
			2048	A739 A780A	KIT HS35A2048-NV KIT HS35A/B2048-NV		4 4	Shaft Mount, 5-26 VDC, with 10 pin connector/mate Shaft Mount, 5-26 VDC, with 10 pin connector/mate (REPLACES BEI A780)		
				Avtron HS35M	1024		A742	KIT HS35M1024	\$1,674	4
			Avtron M3	1024	A753		KIT M31024-NV	\$2,800	10	Shaft Mount, 5-24 VDC, with EPIC connector/mate
		Avtron AV56	1024	A793	KIT M561024-NV	\$2,283	5	Modular Mount, 5-24 VDC, with EPIC connector/mate, Double C-Face		
			1024	A779	KIT HS35B1024-NV	\$1,446	3	Shaft Mount, 5-28 VDC, with 10 pin connector/mate (To Be Discontinued)		
		2048	A780	KIT HS35B2048-NV						
		Dynapar HS20	1024	A687	KIT HS201024-NV	\$672	3	Shaft Mount, 5-26 VDC, with 10 pin connector/mate		
		Dynapar HS35R	1024	A772	KIT HS351024-NV	\$1,446	3	Shaft Mount, 5-26 VDC, with 10 pin connector/mate		
			2048	A776	KIT HS352048-NV					
		EPC 260	2048	A686	KIT EPC260 2048	\$672	3	Shaft Mount, 5-16 VDC, with M12 Connector (To Be Discontinued)		
		NorthStar HSD35	1024	A711	KIT HSD351024-NV	\$1,562	4	Shaft Mount, 5-26 VDC, with EPIC connector/mate		
			512	A785	KIT LKSR512	\$2,283	5	Modular Mount, 5-15 VDC, with EPIC connector/mate		
A763	KIT LKSR02			\$2,283	5	Modular Mount, 5-15 VDC, with EPIC connector/mate				
A786	KIT LKSR-CFACE			\$2,510	5	Modular Mount, 5-15 VDC, with EPIC connector/mate, Double C-Face				
1024	A737		KIT HS35A1024-FC	\$1,446	4	Shaft Mount, 5-26 VDC, with 10 pin connector/mate				
Avtron HS35A	2048	A783A A740	KIT HS35A/B1024-FC KIT HS35A2048-FC		4 4	Shaft Mount, 5-26 VDC, with 10 pin connector/mate (REPLACE BEI A783) Shaft Mount, 5-26 VDC, with 10 pin connector/mate				
	Avtron HS35M	1024	A784A A742		KIT HS35A/B2048-FC KIT HS35M1024	4 4	Shaft Mount, 5-26 VDC, with 10 pin connector/mate (REPLACE BEI A784) Shaft Mount, 5-24 VDC, with EPIC connector/mate			
Avtron M3	1024	A754	KIT M31024-FC		\$2,800	10	Shaft Mount, 5-24 VDC, with EPIC connector/mate			
BEI HS35	1024	A783	KIT HS35B1024-FC	\$1,446	3	Shaft Mount, 5-28 VDC, with 10 pin connector/mate (To Be Discontinued)				
	2048	A784	KIT HS35B2048-FC							
Dynapar HS35R	1024	A774	KIT HS351024-FC	\$1,446	3	Shaft Mount, 5-26 VDC, with 10 pin connector/mate				
	2048	A777	KIT HS352048-FC							
NorthStar HSD35	1024	A712	KIT HSD351024-FC	\$1,562	4	Shaft Mount, 5-26 VDC, with EPIC connector/mate				
	Avtron HS35A	1024	A738	KIT HS35A1024-BC	\$1,446	3	Shaft Mount, 5-26 VDC			
TEBC (1" bore)	182-449	Avtron AV56	1024	A794	KIT M561024-BC	\$2,283	4	Shaft Mount, 5-24 VDC		
		BEI HS35	1024	A781	KIT HS35B1024-BC	\$1,446	3	Shaft Mount, 5-28 VDC, (To Be Discontinued)		
			2048	A782	KIT HS35B2048-BC					
		Dynapar HSD38	1024	A775	KIT HS351024-BC	\$1,446	3	Shaft Mount, 5-26 VDC		
			2048	A778	KIT HS352048-BC					
		NorthStar SL56	1024	A764	KIT LKSR03	\$2,283	5	Modular Mount, 5-15 VDC		
		Turck A02H	1024	A668	KIT A02H1024-BC LED	\$1,624	4	Shaft Mount, 5-30VDC, bulkhead (A801 not required), LED cordset (3m)		
2048	A669		KIT A02H2048-BC LED							
ALL		A801	KIT ENCB0X	\$152	2	Encoder Conduit Box (required for all TEBC encoders except Turck A02H)				
TENV BRAKE- MOTORS	143-256	Avtron AV56	1024	A748	KIT M561024BRK-140	\$2,283	4	Fits Blue Max® Brakemotors (Y986, Y987)		
				A749	KIT M561024BRK-182		4	Fits Blue Max® Brakemotors (Y988)		
				A750	KIT M851024BRK-184		8	Fits Blue Max® Brakemotors (Y989)		
		Avtron M85	1024	A751	KIT M851024BRK-210	\$3,080	8	Fits Blue Max® Brakemotors (Y990, Y991)		
				A752	KIT M851024BRK-250		8	Fits Blue Max® Brakemotors (Y992, Y993)		
		NorthStar SL56	1024	A786	KIT LKSR-CFACE	\$2,510	5	Fits Blue Max® Brakemotors (Y986, Y987)		
				A789	KIT SL561024-182NV		5	Fits Blue Max® Brakemotors (Y988)		
		NorthStar SL85	1024	A790	KIT SL851024-184NV	\$3,080	8	Fits Blue Max® Brakemotors (Y989)		
				A791	KIT SL851024-210NV		8	Fits Blue Max® Brakemotors (Y990, Y991)		
				A792	KIT SL851024-250NV		8	Fits Blue Max® Brakemotors (Y992, Y993)		
CABLE KITS	56-449	Danaher Controls	N/A	A688-10	KIT A688-10	\$279	3	10' cable and pre-wired 10-pin connector for all 10 pin (MS) connectors		
			N/A	A688-20	KIT A688-20	\$393	3	20' cable and pre-wired 10-pin connector for all 10 pin (MS) connectors		
			N/A	A688-25	KIT A688-25	\$446	4	25' cable and pre-wired 10-pin connector for all 10 pin (MS) connectors		
			N/A	A688-30	KIT A688-30	\$502	4	30' cable and pre-wired 10-pin connector for all 10 pin (MS) connectors		
			N/A	A688-50	KIT A688-50	\$725	5	50' cable and pre-wired 10-pin connector for all 10 pin (MS) connectors		
			N/A	A688-60	KIT A688-60	\$836	5	60' cable and pre-wired 10-pin connector for all 10 pin (MS) connectors		
			N/A	A688-100	KIT A688-100	\$1,280	10	100' cable and pre-wired 10-pin connector for all 10 pin (MS) connectors		
			N/A	A690-15	KIT A690-15	\$231	3	15 feet bulk cable, for use with NorthStar encoders		

KITS AND ACCESSORIES

### Encoder Stub Shaft Kit

Fits XRI® Severe Duty or XRI® IEEE-841 motors to allow the addition of 1" bore hollow shaft encoders on opposite drive end of motor.

CAT. NO.	KIT NO.	LIST PRICE	FRAME	WEIGHT	WHERE USED
A807	KIT STUBSHAFT 1IN	\$168	182T-449T/TS	3	FAN COOLED SEVERE DUTY AND IEEE-841

All Kits Listed on This Page are Stock

# Accessory Kits - Multiplier Symbol E3

## Shaft Grounding Kits



### Shaft Grounding:

Shaft grounding is recommended (NEMA MG1 31.4.4.3) as an effective means of bearing protection for motors operated from inverter power. One grounding device is adequate to bleed down inverter-sourced shaft voltages, thereby protecting both bearings for motors as large as 6085 frame.

### SGR Kit:

Kit includes grounding ring, adhesive mounting hardware and instructions (for domestic products only).

### SGR Universal Kit:

Kit includes grounding ring, all mounting hardware needed to mount to any standard drive end bracket and instructions.

Shaft ground rings fit these NEMA shaft extension frames listed below, they are designed to mount on the shaft end. For larger frames, please contact Marathon Motors.

### SGR Kit

FRAME	SGR KIT NO.	SGR CAT. NO.	LIST PRICE	WEIGHT
48	KIT SGR-11.2	A500-5	\$218	2
56	KIT SGR-14.4	A500-8	\$218	1
143-145T	KIT SGR-20.7	A500-14	\$232	2
182-184T	KIT SGR-27.1	A500-20	\$252	1
213-215T	KIT SGR-33.4	A500-26	\$284	1
254-256T	KIT SGR-39.8	A500-32	\$351	1
284-286T	KIT SGR-46.1	A500-38	\$419	1
284-286TS	KIT SGR-39.8	A500-32	\$351	1
324-326T	KIT SGR-52.5	A500-44	\$485	1
324-326TS	KIT SGR-46.1	A500-38	\$419	1
364-365T	KIT SGR-58.8	A500-50	\$551	1
364-365TS	KIT SGR-46.1	A500-38	\$419	1
404-405T	KIT SGR-71.5	A500-62	\$815	1
404-405TS	KIT SGR-52.5	A500-44	\$485	1
444-445T	KIT SGR-84.2	A500-74	\$1,168	1
444-445TS	KIT SGR-58.8	A500-50	\$551	1
447/449T	KIT SGR-84.2	A500-74	\$1,168	1
447/449TS	KIT SGR-58.8	A500-50	\$551	1
5000LS	KIT SGR-71.5	A500-62	\$815	1

### SGR Universal Kit

SGR KIT NO.	SGR UKIT CAT. NO.	LIST PRICE	WEIGHT
---	---	---	---
KIT SGR-0.625-UK	A499-1	\$338	5
KIT SGR-0.875-UK	A499-2	\$365	5
KIT SGR-1.125-UK	A499-3	\$391	5
KIT SGR-1.375-UK	A499-4	\$417	5
KIT SGR-1.625-UK	A499-5	\$522	5
KIT SGR-1.875-UK	A499-6	\$574	5
KIT SGR-1.625-UK	A499-5	\$522	5
KIT SGR-2.125-UK	A499-7	\$653	7
KIT SGR-1.875-UK	A499-6	\$574	5
KIT SGR-2.375-UK	A499-8	\$706	7
KIT SGR-1.875-UK	A499-6	\$574	5
KIT SGR-2.875-UK	A499-9	\$915	7
KIT SGR-2.125-UK	A499-7	\$653	7
KIT SGR-3.375-UK	A499-10	\$1,230	7
KIT SGR-2.375-UK	A499-8	\$706	7
KIT SGR-3.375-UK	A499-10	\$1,230	7
KIT SGR-2.375-UK	A499-8	\$706	7
---	---	---	---

### Conductive Epoxy:

Epoxy comes in two 7g syringes, 14g (0.35 oz). This two part epoxy offers high electrical conductivity and strong conductive bonding. Use in place of traditional end bracket drilling.

CAT. NO.	KIT NO.	LIST PRICE	WEIGHT
A496	EP2400	\$511	2

### Replacement ground brush mounting hardware and brushes

CAT. NO.	KIT NO.	LIST PRICE	WEIGHT	COMMENTS
A103	KIT 103	\$349	1	Drive end mount
A116	KIT 116	\$504	1	Non-drive end mount
A109	KIT 109	\$55	1	Replacement Brush

**⚠ WARNING:** Grounding devices may not be installed on motors used in Division 1 or Division 2 hazardous locations.

All Kits Listed on This Page are Stock

# Accessory Kits - Multiplier Symbol S4

## Transition Bases

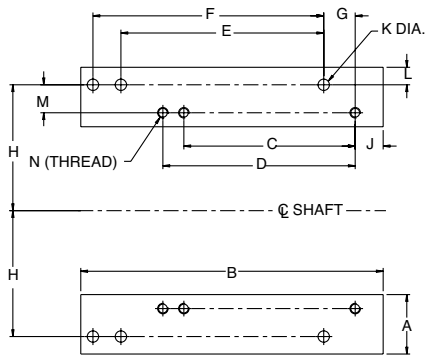

### Application:

Convert "T" frame ratings to "U" frame based dimensions and shaft heights. Shaft dimensions may vary from actual "U" frame specifications.

Dimensions = Inches

CAT. NO.	KIT NO.	CONVERTS		A	B	HGT	C	D	E	F	G	H	J	K	L	M	N (THREAD)	APP. WGT.	LIST PRICE
		FROM	TO																
1814T	KIT 180U	143/5T	182/4	2 1/4	7 1/2	1	4	5	4 1/2	5 1/2	1/2	3 3/4	1	7/16	1/2	1	5/16-18	2	\$147
2118T	KIT 210U	182/4T	213/5	1 3/4	9 1/2	3/4	4 1/2	5 1/2	5 1/2	7	1	4 1/4	1	7/16	7/16	1/2	3/8-16	3	\$186
25U21T	KIT 250U	213/5T	254/6U	2 7/16	12 3/4	1	5 1/2	7	8 1/4	10	1 1/8	5	1	9/16	5/8	3/4	3/8-16	5	\$186
28U25T	KIT 280U	254/6T	284/6U	2 3/4	14 1/4	3/4	8 1/4	10	9 1/2	11	1 3/8	5 1/2	1 1/4	9/16	15/16	1/2	1/2-13	8	\$186
32U28T	KIT 320U	284/6T	324/6U	3 1/4	15 3/4	1	9 1/2	11	10 1/2	12	1 1/2	6 1/4	1 1/2	11/16	15/16	3/4	1/2-13	10	\$220
36U32T	KIT 360U	324/6T	364/5U	3 11/16	16 1/2	1	10 1/2	12	11 1/4	12 1/4	1 3/4	7	1 3/4	11/16	13/16	3/4	5/8-11	13	\$260
40U36T	KIT 400U	364/5T	404/5U	4 1/4	18 5/8	1	11 1/4	12 1/4	12 1/4	13 3/4	2	8	2	13/16	1 1/4	1	5/8-11	22	\$333
44U40T	KIT 440U	404/5T	444/5U	4 1/4	21 5/8	1	12 1/4	13 3/4	14 1/2	16 1/2	2 1/4	9	2	13/16	1 1/4	1	3/4-10	24	\$333

## Adjustable Motor Bases (Slide Bases)

Series F

Series G & H

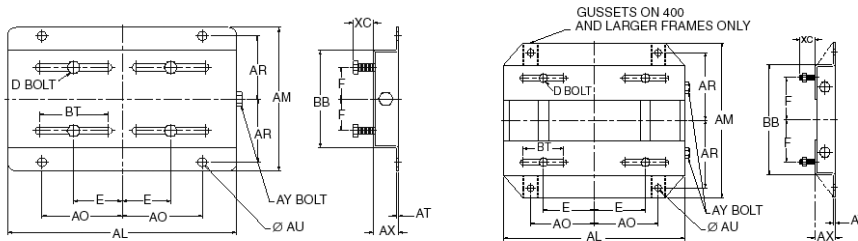

### Application:

Used to adjust tension during motor installation. Made with heavy duty steel construction with single screw adjustment for 143T-215T Frame and double screw adjustment for 254T Frame and larger.

Dimensions = Inches

SERIES	FRAME	CAT. NO.	KIT NO.	AL	AM	AX	BB	E	F	AO	AR	AU	BT	AT	XC	D BOLT	AY BOLT	WGHT. LBS.	LIST PRICE
F	143	143A	KIT 143SB	10 1/2	7 1/2	1 1/8	5 1/2	2 3/4	2	3 3/4	3 3/8	3/8	3	0.119	13/16	5/16 x1	3/8x4	5	\$90
F	145	145A	KIT 145SB	10 1/2	8 1/2	1 1/8	6 1/2	2 3/4	2 1/2	3 3/4	3 7/8	3/8	3	0.119	13/16	5/16x1	3/8x4	6	\$100
F	182	182A	KIT 182SB	12 3/4	9 1/2	1 1/2	6 1/2	3 3/4	2 1/4	4 1/2	4 1/4	1/2	3	0.134	1 1/2	3/8x1 3/4	1/2x6	9	\$120
F	184	184A	KIT 184SB	12 3/4	10 1/2	1 1/2	7 1/2	3 3/4	2 3/4	4 1/2	4 3/4	1/2	3	0.134	1 1/2	3/8s 1 3/4	1/2x6	9	\$193
F	213	213A	KIT 213SB	15	11	1 3/4	7 1/2	4 1/4	2 3/4	5 1/4	4 3/4	1/2	3 1/2	0.164	1 1/2	3/8x1 3/4	1/2x6	13	\$228
F	215	215A	KIT 215SB	15	12 1/2	1 3/4	9	4 1/4	3 1/2	5 1/4	5 1/2	1/2	3 1/2	0.164	1 1/2	3/8x1 3/4	1/2x6	15	\$377
G	254	254B2	KIT 254SB	17 3/4	15 1/8	2	10 3/4	5	4 1/8	6 1/4	6 5/8	5/8	4	3/16	1 7/16	1/2x1 3/4	5/8x6	17	\$493
G	256	256B2	KIT 256SB	17 3/4	16 7/8	2	12 1/2	5	5	6 1/4	7 1/2	5/8	4	3/16	1 7/16	1/2x1 3/4	5/8x6	18	\$720
G	284	284B2	KIT 284SB	19 3/4	16 7/8	2	12 1/2	5 1/2	4 3/4	7	7 1/2	5/8	4 1/2	3/16	2 1/2	1/2x2	5/8x6	21	\$996
G	286	286B2	KIT 286SB	19 3/4	18 3/8	2	14	5 1/2	5 1/2	7	8 1/4	5/8	4 1/2	3/16	2 1/2	1/2x2	5/8x6	22	\$1,192
G	324	324B2	KIT 324SB	22 3/4	19 1/4	2 1/2	14	6 1/4	5 1/4	8	8 1/2	3/4	5 1/4	3/16	2 3/16	5/8x2 1/2	3/4x9	31	
G	326	326B2	KIT 326SB	22 3/4	20 3/4	2 1/2	15 1/2	6 1/4	6	8	9 1/4	3/4	5 1/4	3/16	2 3/16	5/8x2 1/2	3/4x9	32	
G	364	364B2	KIT 364SB	25 1/2	20 1/2	2 1/2	15 1/2	7	5 5/8	9	9 1/8	3/4	6	1/4	2 1/16	5/8x2 1/2	3/4x9	44	
G	365	365B2	KIT 365SB	25 1/2	21 1/2	2 1/2	16 1/2	7	6 1/8	9	9 5/8	3/4	6	1/4	2 1/16	5/8x2 1/2	3/4x9	45	
H	404	404B2	KIT 404SB	28 3/4	22 3/8	3	16 1/2	8	6 1/8	10	9 7/8	7/8	7	1/4	2 1/2	3/4x3	3/4x11	60	
H	405	405B2	KIT 405SB	28 3/4	23 7/8	3	18	8	6 7/8	10	10 5/8	7/8	7	1/4	2 1/2	3/4x3	3/4x11	61	
H	444	444B2	KIT 444SB	31 1/4	24 5/8	3	19 1/4	9	7 1/4	11	11	7/8	7 1/2	1/4	2 1/2	3/4x3	3/4x11	67	
H	445	445B2	KIT 445SB	31 1/4	26 5/8	3	21 1/4	9	8 1/4	11	12	7/8	7 1/2	1/4	2 1/2	3/4x3	3/4x11	69	
H	447	447B2	KIT 447SB	31 1/4	30 1/8	3	24 3/4	9	10	11	13 3/4	7/8	7 1/2	5/16	3	3/4x3 1/2	3/4x11	92	
H	449	449B2	KIT 449SB	31 1/4	35 1/8	3	29 3/4	9	12 1/2	11	16 1/4	7/8	7 1/2	5/16	3	3/4x3 1/2	3/4x11	95	

All Kits Listed on This Page are Stock

## New & Improved - [www.marthonelectric.com](http://www.marthonelectric.com)



As previously announced the new and improved Marathon Motors website is "live." The new website is a great resource for selecting products, providing technical data, catalogs, brochures, outline drawings, ME-Business eCommerce site and much, much more.

Not only has the look changed, the features have as well. A few of these include: competitive cross-reference, distributor search, motor date code chart and instructions on how to read a model number. A competitive cross reference allows you to find the equivalent Marathon motor to a number of other brands.

The new website is very user-friendly. Simply log onto [www.marthonelectric.com](http://www.marthonelectric.com). Click on the 'motors' link. If you know the model or catalog number, simply enter it in the search tool at the top of the page. Other functions are listed below.

### Products

- AC Motors Search
- DC Motors Search
- Competitive Cross Reference

### ME Business

- Log-In Screen

### Contact Us

- Home Office Information

### Service & Support

- Service Locations
- Distributor Search
- Service Parts
- Standard Warranty Policy
- Frequently Asked Questions
- Motor Date Codes
- How to Read a Model Number
- Warranty Forms

### Literature

- Catalogs & Brochures
- Installation, Operation, & Maintenance Manuals
- Terms & Conditions

Log on to the new [www.marthonelectric.com](http://www.marthonelectric.com) today!

## SyMAX® Permanent Magnet AC Motors

# The most sustainable motor available today



SyMAX® Industrial – Cast Iron Severe Duty  
NEMA 182-286T – IEC 132-180



SyMAX-i® with Intellidrive™



### Looking for the next level of efficiency?

SyMAX® PMAC motors deliver impressive energy savings by the elimination of rotor conductor losses, optimized fan design, precision-wound stator and variable speed operation. These Ultra Efficient™ motors surpass European IE4 efficiency levels...5 years ahead of scheduled implementation, achieving efficiencies 25-35% over NEMA Premium™! The energy savings alone often pays for the motor in as little as two years. Additionally, the SyMAX® efficiency profile remains flatter than an equivalent induction motor as the speed and load declines, allowing the user to capture even greater energy savings when operated at the application's ideal speed.

Electric motors consume an estimated 25% of all electricity and up to 65% of all electrical energy consumed by industrials. Energy costs are projected to continue to increase in the future. A "mere" 1% gain in energy efficiency would reduce carbon emissions by an estimated 80 million tons per year. SyMAX® motors provide a very cost-effective way to reduce our "carbon footprint" and assure a cleaner environment.

SyMAX® motors provide the highest level of reliability and longevity, coupled with low maintenance costs, due to their low operating temperature, high ingress protection levels and ultra-precision balancing techniques.

# Specials Are Our Specialty

143-449T, IP56,  
Hazardous Duty™  
Class I and II,  
Groups C, D, F & G



6805 DPFV  
Cast Iron, Force Ventilated, F2



Roller Table Motor - Round  
Annular fin design, Cast Iron,  
FF Flange, F4



Roller Table Motor -  
Footed  
Annular fin design, Cast Iron,  
F4



5007 - 5010 Frame  
All New designs



TEFC FIRE PUMP  
3Hp to 450Hp,  
Red Paint



Shaker Duty,  
Hazardous Duty™  
210-360 Frame, Round,  
Dual Flange



280 IEC TEBC  
Blower Cooled, Ground  
Brush, F3



440TCZ TEFC  
Cast Iron,  
Tapered ODE Shaft, F2





# Specials Are Our Specialty

320TCZ TEFC  
Special Shaft, C-Face



Ground Brush  
Opposite Drive End

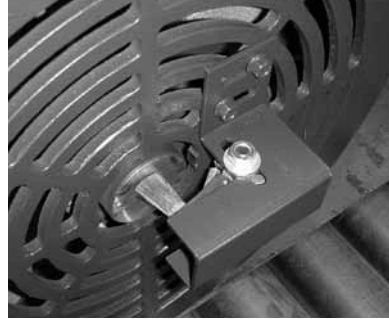

AEGIS® Shaft Grounding  
Ring  
Drive End



320 TCZ TEBC  
Blower Cooled, Special  
ODE shaft, C-Face



320 TZ TENV  
Non Ventilated, Special  
ODE Shaft, Encoder



5007-5013 Vertical Frames  
TENV and TEFC



400TC TEBC  
Blower Cooled, C-Face, F3



Marathon's "IntelliBrake"  
Stearns & Dings Brakes  
with Imbedded Encoder



440TD TEFC Round  
Cast Iron, Round, D-Flange



# Index

## Catalog Number/Model Number

CAT. NO.	MODEL NO.	STOCK	PAGE NO.	CAT. NO.	MODEL NO.	STOCK	PAGE NO.	CAT. NO.	MODEL NO.	STOCK	PAGE NO.	MODEL NO.	CAT. NO.	STOCK	PAGE NO.
25U21T	KIT 250U	✓	219	3727	SEE X411		180	4707	SEE 4757		166	A161	KIT 210TCD-WD	✓	205
28U25T	KIT 280U	✓	219	3728	SEE X412		158	4708	5KH39QN9401T	✓	166	A162	KIT 250TCD2-WD	✓	205
32U28T	KIT 320U	✓	219	3729	SEE X413		158	4722	5KH39QN5558T	✓	174,181	A163	KIT 250TCD-WD	✓	205
36U32T	KIT 360U	✓	219	3730	SEE X414		158	4725	5KH32DN5587X	✓	119	A164	KIT 280TCD2-WD	✓	205
40U36T	KIT 400U	✓	219	3732	SEE X412		158	4730	5KH39QN9725T	✓	170	A165	KIT 280TCD-WD	✓	205
44U40T	KIT 440U	✓	219	3733	SEE X415		158	4731	5KH39QN9696X	✓	170	A166	KIT 320TCD2-WD	✓	205
143A	KIT 143SB	✓	219	3736	SEE X456		158	4732	5KH39QN9702T	✓	170	A167	KIT 320TCD-WD	✓	205
145A	KIT 145SB	✓	219	3737	SEE X457		158	4733	5KH39DNA533T	✓	170	A168	KIT 360TCD2-WD	✓	205
182A	KIT 182SB	✓	219	3738	SEE X458		158	4734	5KH32HNA532T	✓	170	A169	KIT 360TCD-WD	✓	205
184A	KIT 184SB	✓	219	3739	SEE X459		158	4735	5KH33JNA534T	✓	170	A170	KIT 180TCF-WD	✓	206
213A	KIT 213SB	✓	219	3746	SEE X452		158	4738	5KH39QN9703T	✓	170	A171	KIT 210TCF-WD	✓	206
215A	KIT 215SB	✓	219	3783	SEE X034		163	4739	5KH39QN9704T	✓	170	A172	KIT 250TCF2-WD	✓	206
254B2	KIT 254SB	✓	219	3785	SEE X035		163	4757	5KH39QN9636T	✓	166	A173	KIT 250TCF-WD	✓	206
256B2	KIT 256SB	✓	219	3787	SEE X036		163	4758	5KH39QN9698T	✓	166	A174	KIT 280TCF2-WD	✓	206
284B2	KIT 284SB	✓	219	3945	SEE X445		159	4759	5KH39QN9697T		166	A175	KIT 280TCF-WD	✓	206
286B2	KIT 286SB	✓	219	3946	SEE X446		159	4773	SEE O005		171	A176	KIT 320TCF2-WD	✓	206
324B2	KIT 324SB	✓	219	4050	SEE 4370		166	4774	5KH33GN5014U	✓	171	A177	KIT 320TCF-WD	✓	206
326B2	KIT 326SB	✓	219	4304	5KH39QN5543	✓	165	4776	5KH39QN5539T	✓	26	A178	KIT 360TCF2-WD	✓	206
364B2	KIT 364SB	✓	219	4305	5KH39QN5511X	✓	165	4777	SEE O701		171	A179	KIT 360TCF-WD	✓	206
365B2	KIT 365SB	✓	219	4306	5KH39QN5537X	✓	165	4778	5KH39QN9639T	✓	26	A181	KIT 143TCTN-841	✓	207
404B2	KIT 404SB	✓	219	4308	SEE 4706		166	4779	SEE O100		171	A182	KIT 180TCFS-841	✓	207
405B2	KIT 405SB	✓	219	4309	5KH39QN9514X	✓	166	4781	5KC37HN3898U		171	A183	KIT 210TCF-841	✓	207
444B2	KIT 444SB	✓	219	4310	5KH39QN5508X		26	4782	SEE O600		171	A184	KIT 250TCFNA-841	✓	207
445B2	KIT 445SB	✓	219	4311	5KH39QN5529X	✓	26	4784	SEE O601		171	A185	KIT 280TCFN-841	✓	207
447B2	KIT 447SB	✓	219	4314	5KH39QN5520X	✓	165	4785	5KH32EN5015U	✓	171	A186	KIT 280TCFNA-841	✓	207
449B2	KIT 449SB	✓	219	4319	5KH39QN9429T	✓	165	4786	SEE O002		171	A187	KIT 320TCFS-841	✓	207
1814T	KIT 180U	✓	219	4322	5KH39QN9548	✓	165	4787	SEE O003		171	A188	KIT 360TCF2-WD	✓	207
2118T	KIT 210U	✓	219	4338	5KH39QN9541T	✓	166	4788	5KC37EN3900U	✓	171	A189	KIT 360TSCFSR-841	✓	207
3001	SEE X230		173,178	4349	5KH39QN9537X	✓	21	4798	5KH35FN153T	✓	165	A190	KIT 400TCFS-841	✓	207
3028	SEE X081		156	4350	5KH39QN5538X	✓	165	4805	5KH32GNB811X	✓	119	A191	KIT 400TSCFS-841	✓	207
3037	SEE X090		157	4351	5KH39QN9542	✓	23	9029	5KC49NN0221X	✓	23	A192	KIT 440TCFS-841	✓	207
3048	SEE X085		157	4352	SEE S102		25	9030	5KC49NN0222X		189	A193	KIT 440TSCFS-841	✓	207
3050	SEE X209		162,180	4354	5KH39QN9538	✓	21	9031	5KC49MN2043Y	✓	21,183	A194	KIT 440TCFN-841	✓	207
3070	SEE X200		181	4359	5KH39QN5523	✓	25	9032	5KC49MN2049Y	✓	21,183,189	A195	KIT 440TSCFN-841	✓	207
3082	SEE X236		162,177,180	4360	5KH39QN5548	✓	165	9033	5KC49NN2050Y	✓	21,183	A195-(GE)	SEE AG195		211
3084	SEE X441		157	4362	5KH39QN9686X	✓	21	9034	5KC49NN2044Y	✓	23	A197	KIT 197	✓	214
3085	SEE X442		157	4363	5KH39QN5526X	✓	165	9035	5KCR48TN2650Y	✓	23,183	A198	KIT 198	✓	214
3086	SEE X443		157	4364	5KH39QN5541X	✓	25	9036	5KCR48UN2653Y	✓	22,183	A199	KIT 199	✓	214
3132	SEE X203		177	4368	5KH39QN9397		23	9038	5KCR49ZN2722Y	✓	23,183	A201	KIT 201	✓	214
3155	SEE X278		157,180	4369	5KH39QN5508	✓	26	9040	5KCR48UN2654Y	✓	183	A202	KIT 202	✓	214
3204	SEE X450		158	4370	5KH39QN9682	✓	166	A000	KIT 391-200-01	✓	215	A204	KIT 210TCFL	✓	206
3205	SEE X451		158	4371	5KH39QN5529	✓	26	A001	KIT 391-200-02	✓	215	A206	KIT 210TCFS	✓	206
3206	SEE X302		174	4372	5KH39QN9546	✓	23	A100	KIT 100	✓	212	A209	KIT 250TCFL	✓	206
3208	SEE X303		174	4373	5KH39QN9543	✓	23	A103	KIT 103	✓	218	A212-(GE)	SEE AG212		205
3212	SEE X304		174	4376	5KH39QN9547	✓	23	A104	KIT 104	✓	211	A214	KIT 320TCFS	✓	206
3220	SEE X216		157,180	4377	5KH39QN5524	✓	26	A105	KIT 105	✓	213	A215-(GE)	SEE AG215		206
3221	SEE X297		157,180	4380	5KH39QN9681X	✓	23	A106	KIT 106	✓	213	A216	KIT 360TCD5	✓	205
3230	SEE X416		158	4381	5KH39QN5528X	✓	26	A107	KIT 107-637	✓	210	A217	KIT 360TCFS	✓	206
3280	SEE X037		163	4383	5KH39QN9513X	✓	166	A109	KIT 109	✓	218	A219	KIT 360TSCDS	✓	205
3288	SEE X405		177	4386	SEE S120		26	A109-(GE)	SEE AG109		210	A222	KIT 400TSCDS	✓	205
3290	SEE X039		163	4387	5KH39QN9684	✓	26	A110	KIT 110	✓	211	A223	KIT 400TCFS	✓	206
3328	SEE X213		156	4389	5KH39QN9548X	✓	165	A110-(GE)	SEE AG110		210	A224-(GE)	SEE A105		213
3329	SEE X214		157	4390	5KH39QNA039	✓	166	A111	KIT 111	✓	212	A225	KIT 400TSCDS	✓	205
3330	SEE X221		157	4392	5KH39QN9405X	✓	166	A111-(GE)	SEE AG111		210	A225-(GE)	SEE A106		213
3331	SEE X298		157	4393	5KH39QN9544X	✓	166	A112	KIT 112	✓	211	A226	KIT 400TSCFS	✓	206
3463	SEE X077		176	4396	5KH39QN9683	✓	165	A112-(GE)	SEE AG112		210	A228	KIT 440TSCDS	✓	205
3464	SEE X073		176	4399	5KH39QN9551X	✓	165	A113	KIT 113	✓	211	A228-(GE)	SEE AG228		213
3465	SEE X072		175	4404	5KH39QN5550X	✓	174,181	A113-(GE)	SEE AG113		210	A229	KIT 440TCFS	✓	206
3466	SEE X074		176	4406	5KH32FN5586X	✓	119	A114	KIT 114	✓	211	A229-(GE)	SEE AG229		213
3467	SEE X075		176	4412	5KH39QN9550X	✓	165	A114-(GE)	SEE AG114		210	A231	KIT 440TSCDS	✓	205
3468	SEE X076		175	4422	5KH39QN9687	✓	26	A115-(GE)	SEE AG115		210	A232	KIT 440TSCFS	✓	206
3583	SEE X000		162	4602	5KH39QN9518X	✓	26	A116	KIT 116	✓	218	A234	KIT 234	✓	214
3584	SEE X001		162	4680	5KH32FN3120T	✓	165	A119	KIT 364-445CB	✓	214	A239	KIT 250TCFPA	✓	206
3585	SEE X002		162	4682	5KH35JN3132T	✓	166	A125-(GE)	SEE AG125		210	A240	KIT 240	✓	210
3586	SEE X003		162	4684	5KH36MN3127T	✓	166	A127-(GE)	SEE AG127		210	A241	KIT 241	✓	210
3587	SEE X004		162	4686	5KC46LN0269X	✓	167	A128-(GE)	SEE AG128		210	A242	KIT 242	✓	210
3588	SEE X005		162	4688	5KC49NN0061T	✓	167	A129-(GE)	SEE AG129		210	A243	KIT 243	✓	212
3589	SEE X009		162	4701	5KH39QN5512T	✓	165	A130-(GE)	SEE AG130		210	A244	KIT 244	✓	212
3590	SEE X010		162	4702	5KH33HN5725X	✓	165	A157	KIT VRT87BRK	✓	209	A245	KIT 245	✓	212
3596	SEE X023		162	4706	5KH39QN5514T	✓	166	A160	KIT 180TCD-WD	✓	205	A247	KIT 247	✓	214

CAT. NO.	MODEL NO.	STOCK	PAGE NO.	CAT. NO.	MODEL NO.	STOCK	PAGE NO.	CAT. NO.	MODEL NO.	STOCK	PAGE NO.	CAT. NO.	MODEL NO.	STOCK	PAGE NO.
A248	KIT 248	✓	214	A449	KIT 440-17.5	✓	212	A581	KIT 175985	✓	208	A668	KIT A02H1024-BC LEDV	✓	217
A249	KIT 249	✓	211	A459-(GE)	SEE A104		211	A581A	KIT 175817	✓	208	A669	KIT A02H2048-BC LEDV	✓	217
A250	KIT 250	✓	211	A478-(GE)	SEE A111		212	A582	KIT 175987	✓	208	A686	KIT EPC260 2048	✓	217
A251	KIT 251	✓	211	A487-(GE)	SEE A243		212	A582A	KIT 175818	✓	208	A687	KIT HS201024-NV	✓	217
A252	KIT 252	✓	211	A488-(GE)	SEE A244		212	A582B	KIT 175832	✓	208	A688-10	KIT A688-10	✓	217
A253	KIT 253	✓	211	A489-(GE)	SEE A245		212	A583	KIT 175989	✓	208	A688-20	KIT A688-20	✓	217
A254	KIT 254	✓	211	A493-(GE)	SEE A114		211	A583A	KIT 175819	✓	208	A688-25	KIT A688-25	✓	217
A256	KIT 256	✓	213	A494-(GE)	SEE A110		211	A584	KIT 175991	✓	208	A688-30	KIT A688-30	✓	217
A257	KIT 257	✓	213	A496	KIT EP2400	✓	218	A585	KIT 175900	✓	208	A688-50	KIT A688-50	✓	217
A258	KIT 258	✓	213	A499-1	KIT SGR-0.625-UK	✓	218	A586	KIT 175901	✓	208	A688-60	KIT A688-60	✓	217
A259	KIT 259	✓	212	A499-2	KIT SGR-0.875-UK	✓	218	A587	KIT 175902	✓	208	A688-100	KIT A688-100	✓	217
A261	KIT 261	✓	214	A499-3	KIT SGR-1.125-UK	✓	218	A588	KIT 175903	✓	208	A690-15	KIT A690-15	✓	217
A262	KIT 145TCTN-841	✓	207	A499-4	KIT SGR-1.375-UK	✓	218	A589	KIT 175833	✓	208	A691	KIT 25TEBCNA	✓	216
A277	KIT 277	✓	212	A499-5	KIT SGR-1.625-UK	✓	218	A590	KIT 175834	✓	208	A692	KIT 21TEBC	✓	216
A278	KIT 278	✓	212	A499-6	KIT SGR-1.875-UK	✓	218	A594	KIT 175835	✓	208	A695	KIT 32TEBC	✓	216
A279	KIT 279	✓	210	A499-7	KIT SGR-2.125-UK	✓	218	A596	KIT 175836	✓	208	A696	KIT 36TEBC	✓	216
A280	KIT 280	✓	210	A499-8	KIT SGR-2.375-UK	✓	218	A598	KIT 175837	✓	208	A697	KIT 40TEBC	✓	216
A281	KIT 281	✓	210	A499-9	KIT SGR-2.875-UK	✓	218	A600	KIT 175181	✓	205	A698	KIT 44TEBC-313	✓	216
A282	KIT 282	✓	210	A499-10	KIT SGR-3.375-UK	✓	218	A601	KIT 250TCFP	✓	206	A699	KIT 44TEBC-316	✓	216
A283	KIT 283	✓	210	A500-5	KIT SGR-11.2	✓	218	A602	KIT 175066	✓	205	A700	KIT 44TEBC-318	✓	216
A284	KIT 250TCFNA	✓	206	A500-8	KIT SGR-14.4	✓	218	A603	KIT 143TCFN	✓	206	A701	KIT 28TEBCNA	✓	216
A287	KIT 280TCD	✓	205	A500-14	KIT SGR-20.7	✓	218	A606	KIT 210TCDW	✓	205	A711	KIT HSD351024-NV	✓	217
A293	KIT 440TSCDN	✓	205	A500-20	KIT SGR-27.1	✓	218	A609	KIT 210TCFW	✓	206	A712	KIT HSD351024-FC	✓	217
A297	KIT 3BRK3A	✓	209	A500-26	KIT SGR-33.4	✓	218	A610	KIT 280TCDP	✓	205	A715	KIT 140CB	✓	216
A298	KIT 6BRK3A	✓	209	A500-32	KIT SGR-39.8	✓	218	A611	KIT 280TCFP	✓	206	A718	KIT 180R	✓	216
A299	KIT 10BRKA	✓	209	A500-38	KIT SGR-46.1	✓	218	A612	KIT 250TCDX	✓	205	A720	KIT 180/210CB	✓	214
A301	KIT 3BRK3	✓	209	A500-44	KIT SGR-52.5	✓	218	A613	KIT 320TCDP	✓	205	A721	KIT 210R	✓	216
A302	KIT 6BRK3	✓	209	A500-50	KIT SGR-58.8	✓	218	A614	KIT 320TCFP	✓	206	A722	KIT 250CB	✓	214
A303	KIT 10BRK	✓	209	A500-62	KIT SGR-71.5	✓	218	A615	KIT 280TCFN	✓	206	A723	KIT 250RPPA	✓	216
A306	KIT 3BRK1	✓	209	A500-74	KIT SGR-84.2	✓	218	A617	KIT 280TCFPA	✓	206	A724	KIT 250RFNA	✓	216
A307	KIT 6BRK1	✓	209	A518	161L110AAG4	✓	211	A618	KIT 280TCFNA	✓	206	A725	KIT 250R	✓	216
A308	KIT 308	✓	210	A534	161L187BAG1	✓	205	A619	KIT 320TCFPA	✓	206	A726	KIT 280RPPA	✓	216
A311	KIT 311	✓	214	A535	161L187BCG1	✓	205	A620	KIT 440TCFN	✓	206	A727	KIT 280RFN	✓	216
A312	KIT BM6BRK	✓	209	A536	161L188BAG1	✓	206	A621	KIT 440TSCFN	✓	206	A728	KIT 280R	✓	216
A313	KIT BM10BRK	✓	209	A537	161L188BCG1	✓	206	A622	KIT 175067	✓	205	A729	KIT 280CB	✓	214
A315	KIT BM6BRK575	✓	209	A549	52A101229AAG1	✓	214	A623	KIT 449TCFS	✓	206	A730	KIT 320CB	✓	214
A316	KIT BM10BRK575	✓	209	A550	KIT 175828	✓	208	A624	KIT 449TSCFS-1	✓	206	A731	KIT 280RFNA	✓	216
A317	KIT BM6BRK115	✓	209	A551	KIT 175829	✓	208	A625	KIT 449TSCFS-2	✓	206	A733	KIT 320RPPA	✓	216
A318	KIT BM10BRK115	✓	209	A552	KIT 175830	✓	208	A626	KIT 175058	✓	205	A736	KIT HS35A1024-NV	✓	217
A371	KIT 370-3	✓	212	A553	KIT 175831	✓	208	A627	KIT 175059	✓	205	A737	KIT HS35A1024-FC	✓	217
A372	KIT 370-4	✓	212	A554	KIT 175984	✓	208	A628	KIT 175060	✓	205	A738	KIT HS35A1024-BC	✓	217
A373	KIT 370-5	✓	212	A554A	KIT 175810	✓	208	A629	KIT 175601	✓	205	A739	KIT HS35A2048-NV	✓	217
A375	KIT 370-7.5	✓	212	A555	KIT 175986	✓	208	A630	KIT 180TDFR	✓	207	A740	KIT HS35A2048-FC	✓	217
A376	KIT 370-10	✓	212	A555A	KIT 175811	✓	208	A631	KIT 280TDFP	✓	207	A742	KIT HS35M1024	✓	217
A378	KIT 370-15	✓	212	A555B	KIT 175827	✓	208	A632	KIT 320TDFP	✓	207	A746	KIT HS25A1024-NV	✓	217
A379	KIT 370-17.5	✓	212	A556	KIT 175988	✓	208	A634	KIT 400TDFS	✓	207	A747	KIT HS25A2048-NV	✓	217
A380	KIT 370-20	✓	212	A556A	KIT 175812	✓	208	A637	KIT 360TDFC	✓	207	A748	KIT M561024BRK-140	✓	217
A381	KIT 370-25	✓	212	A557	KIT 175990	✓	208	A640	KIT 180TCN4.5	✓	206	A749	KIT M561024BRK-182	✓	217
A382	KIT 370-30	✓	212	A558	KIT 175890	✓	208	A641	KIT 180TCN8.5	✓	206	A750	KIT M851024BRK-184	✓	217
A395	KIT 360TCFSR	✓	206	A559	KIT 175994	✓	208	A642	KIT 175077	✓	206	A751	KIT M851024BRK-210	✓	217
A396	KIT 360TSCFSR	✓	206	A561	KIT 631475	✓	208	A643	KIT 175296	✓	206	A752	KIT M851024BRK-250	✓	217
A414	KIT 400TCD2-WD	✓	205	A562	KIT 711485	✓	208	A644	KIT 180CF8.5-1	✓	206	A753	KIT M31024-NV	✓	217
A415	KIT 400TCD-WD	✓	205	A563	KIT 8014100	✓	208	A645	KIT 180CF4.5-1	✓	206	A754	KIT M31024-FC	✓	217
A416	KIT 444/5TCD2-WD	✓	205	A564	KIT 9014115	✓	208	A646	KIT 210TCN	✓	206	A755	KIT 360BRFSR-314	✓	216
A417	KIT 444/5TCD-WD	✓	205	A565	KIT 10014130	✓	208	A647	KIT 250TDFPA	✓	207	A756	KIT 400BRFS-316	✓	216
A419	KIT 447/9TCD-WD	✓	205	A566	KIT 11214130	✓	208	A648	KIT 250TDFNA	✓	207	A757	KIT 440BRFS-318	✓	216
A424	KIT 400TCF2-WD	✓	206	A567	KIT 13214165	✓	208	A649	KIT 649R	✓	207	A758	KIT 449BRFS	✓	216
A425	KIT 400TCF-WD	✓	206	A568	KIT 16014215	✓	208	A650	KIT 650R	✓	207	A759	KIT 440BRFN	✓	216
A426	KIT 444/5TCF2-WD	✓	206	A569	KIT 635115	✓	208	A651	KIT 651R	✓	207	A760	KIT 440BBFN	✓	216
A427	KIT 444/5TCF-WD	✓	206	A570	KIT 715130	✓	208	A652	KIT 175068	✓	206	A761	KIT 449BBFS	✓	216
A428	KIT 447/9TCF2-WD	✓	206	A571	KIT 805165	✓	208	A653	KIT 175191	✓	206	A763	KIT LKSR02	✓	217
A429	KIT 447/9TCF-WD	✓	206	A572	KIT 905165	✓	208	A654	KIT 175061	✓	206	A764	KIT LKSR03	✓	217
A435	KIT 56CDR-1	✓	205	A573	KIT 1005215	✓	208	A655	KIT 145TCFN	✓	206	A772	KIT HS351024-NV	✓	217
A436	KIT 140TCDR-1	✓	205	A574	KIT 1125215	✓	208	A656	KIT 280TDFNA	✓	207	A774	KIT HS351024-FC	✓	217
A437	KIT 56CFR-1	✓	206	A575	KIT 1325265	✓	208	A657	KIT 320TDFPA	✓	207	A775	KIT HS351024-BC	✓	217
A438	KIT 140TCFR-1	✓	206	A576	KIT 1605300	✓	208	A658	KIT 320TDFS	✓	207	A776	KIT HS352048-NV	✓	217
A445	KIT 440-7.5	✓	212	A577	KIT 1805300	✓	208	A662	KIT 175614	✓	214	A777	KIT HS352048-FC	✓	217
A446	KIT 440-10	✓	212	A578	KIT 2005350	✓	208	A665	KIT 175076	✓	206	A778	KIT HS352048-BC	✓	217
A447	KIT 440-12.5	✓	212	A579	KIT 2255400	✓	208	A666	KIT 175691	✓	206	A779	KIT HS35B1024-NV	✓	217
A448	KIT 440-15	✓	212	A580	KIT 175995	✓	208	A667	KIT 175844	✓	206	A779A	KIT HS35A/B1024-NV	✓	217

# Index

## Catalog Number/Model Number

CAT. NO.	MODEL NO.	STOCK	PAGE NO.	CAT. NO.	MODEL NO.	STOCK	PAGE NO.	CAT. NO.	MODEL NO.	STOCK	PAGE NO.	MODEL NO.	CAT. NO.	STOCK	PAGE NO.
A780	KIT HS35B2048-NV	✓	217	A1306	KIT BRK-3 115/230	✓	209	B389	SEE H175		166	C168	5KC49GN0010X	✓	21
A780A	KIT HS35A/B2048-NV	✓	217	A1307	KIT BRK-6 115/230	✓	209	B400	048S17D997	✓	155	C169	5KC49GN0010Y	✓	21,183
A781	KIT HS35B1024-BC	✓	217	AG109	161L113AAG1	✓	210	B401	056S17D2062	✓	155	C173	182TCDR8007		27
A782	KIT HS35B2048-BC	✓	217	AG110	161L113AAG2	✓	210	B402	048S17D7209	✓	155	C174	184TCDR7627		27
A783	KIT HS35B1024-FC	✓	217	AG111	161L113AAG3	✓	210	B500	SEE H236		168	C175	5KC46LN0153	✓	21
A783A	KIT HS35A/B1024-FC	✓	217	AG112	161L113AAG4	✓	210	B501	SEE H234		168	C176	5KC46LN0153X	✓	21
A784	KIT HS35B2048-FC	✓	217	AG113	161L113AAG5	✓	210	B502	SEE B1502		168	C177	5KC46LN0153U	✓	21
A784A	KIT HS35A/B2048-FC	✓	217	AG114	161L113AAG6	✓	210	B504	SEE B1504		168	C178	5KCR49WN6075	✓	21
A785	KIT LKSR512	✓	217	AG115	161L113AAG9	✓	210	B506	056S17F5303		168	C179	5KC38RN60	✓	21
A786	KIT LKSR-CFACE	✓	217	AG125	161L113ADG1	✓	210	B507	SEE B1507		168	C180	5KC38RN60X	✓	21
A787	KIT 449BBFS-322	✓	216	AG127	161L113ADG3	✓	210	B600	SEE H176		166	C181	5KC49PN0161	✓	21
A788	KIT 449BBFS-319	✓	216	AG128	161L113ADG4	✓	210	B604	SEE H169		165	C182	5KC49PN0161X	✓	21
A789	KIT SL561024-182NV	✓	217	AG129	161L113ADG5	✓	210	B605	SEE H170		165	C183	5KCR49QN6076	✓	21
A790	KIT SL851024-184NV	✓	217	AG130	161L113ADG14	✓	210	B606	048S17D2116	✓	165	C185	5KCR49SN0068	✓	22
A791	KIT SL851024-210NV	✓	217	AG195	161L110AA1	✓	211	B607	048S17D2117	✓	166	C186	5KCR49SN0068X	✓	22
A792	KIT SL851024-250NV	✓	217	AG212	161L185AAG1	✓	205	B608	056C17D2113	✓	167	C187	5KC48TN2169	✓	22
A793	KIT M561024-NV	✓	217	AG215	161L186AAG1	✓	206	B609	056B17D2013	✓	167	C188	5KC49PN0162	✓	21
A794	KIT M561024-BC	✓	217	AG228	112A515AKG4	✓	213	B703	048N17D14	✓	166	C191	5KCR49SN0065	✓	22
A795	KIT L449BBFS-322	✓	216	AG229	112A515ASG2	✓	213	B1316	5KC49GN0001	✓	24,167	C193	5KCR49WN0270	✓	22
A796	KIT L449TEBC	✓	216	AG234	161L52BAAG1	✓	214	B1502	5KH39QN9105	✓	168	C194	5KCR48TN8062	✓	22
A800	KIT 56 EXPR BOX	✓	214	AG697	161L210AAP1	✓	215	B1504	5KH35MN56	✓	168	C200	5KC35JN12	✓	24
A801	KIT ENCPBOX	✓	217	B100	056S17D2064	✓	166	B1507	5KH42GN0336	✓	168	C201	143TFR5302	✓	51
A803	KIT LDRDCR-M	✓	214	B193	056T34D5357	✓	169	C102	SEE C102A		40	C201A	143TFR4302	✓	51
A807	KIT STUBSHAFT 1IN	✓	217	B200	056S17D2049	✓	166	C102A	145TTDR14007	✓	40	C201-(GE)	SEE CG201		24
A903	KIT 903	✓	209	B201	056S17D2047	✓	165	C103	145TTDR5312	✓	40	C202	SEE C202A		51
A904	KIT 904	✓	209	B202	056S17D2048	✓	166	C104B	182TTDW14008	✓	40	C202A	145TTFR4306	✓	51
A905	KIT 905	✓	209	B206	048S17D2107	✓	165	C105	SEE C105B		40	C202-(GE)	SEE G1114		24,167
A906	KIT 906	✓	209	B207	048S17D2108	✓	166	C105B	184TTDW14017	✓	40	C203	SEE C203B		52
A907	KIT 907	✓	209	B208	048S17D2109	✓	166	C105-(GE)	SEE CG105		23	C203B	182TTFW14004	✓	52
A908	KIT 908	✓	209	B210	SEE C216		24,167	C106	SEE C106A		40	C203-(GE)	SEE G1115		24,167
A909	KIT 909	✓	209	B300	048S17D2052	✓	165	C106A	213TTDW14014	✓	40	C204	SEE C204B		52
A910	KIT 910	✓	209	B302	048S17D2054	✓	165	C111	SEE K1301		40	C204B	184TTFW14004	✓	52
A911	KIT 911	✓	209	B303	048S17D2055	✓	165	C111-(GE)	SEE CG111		23	C205	SEE C205A		52
A940	52D31083AAP001	✓	215	B304	048S17D2056	✓	166	C120	SEE K634A		40	C205A	213TTFW14011	✓	52
A941	52D311808ARP1	✓	215	B305	048S17D2057	✓	166	C121	SEE K622		40	C206	SEE C206A		52
A942	52D310814AAP1	✓	215	B306	048S17D2058	✓	166	C122A	145TTDR4341	✓	40	C206A	215TTFW14024	✓	52
A945	115D964P1	✓	215	B307	048S17D2059	✓	166	C123	182TTDR8067	✓	40	C207	SEE C207A		52
A946	115D964P2	✓	215	B308	SEE H208		170	C123B	182TTDW4028	✓	40	C207A	254TFL14009		52
A947	115D963P1	✓	215	B309	SEE H212		170	C124	SEE C124B		40	C208	5KC35FN51X	✓	24
A948	113A617AG001	✓	215	B310	SEE C235		24,167	C124A	SEE C124B		40	C209	5KC36LN26	✓	24
A949	113A620AYP1	✓	215	B311	SEE 4688		167	C124B	184TTDW14027	✓	40	C210	5KC36LN26X	✓	24
A950	976B399AAP9	✓	215	B312	048C17D2041	✓	167	C125	SEE C125A		40	C215	5KC36LN1	✓	24
A951	976B399AAP12	✓	215	B313	048C17D2042	✓	167	C125A	213TTDW14057		40	C216	5KC36LN1X	✓	24,167
A952	976B399AAP13	✓	215	B314	048C17D2043	✓	167	C126	SEE C126A		40	C220	SEE C220A		51
A953	976B399ABP6	✓	215	B315	048C17D2044	✓	167	C126A	215TTDW14071		40	C220A	143TFR4329	✓	51
A954	976B399ABP9	✓	215	B316	SEE B1316		24,167	C129	5KC35JN23X		26	C221	SEE C221A		51
A955	976B399ABP10	✓	215	B317	056C17D2072	✓	24,167	C133	5KC36MN27X	✓	26	C221A	145TFR4332	✓	51
A956	161L198AAG9	✓	215	B318	056C17D2073	✓	24,167	C136	SEE S113		26	C221-(GE)	SEE B1316		24,167
A957	161L198AAG10	✓	215	B319	056C17D2074	✓	24,167	C138	5KC46JN0002X	✓	24	C222	SEE K2033		51
A958	161L197ABG1	✓	215	B320	SEE H217		170	C145	5KC35JN8X	✓	21	C223	SEE C223B		52
A959	161L197ABG11	✓	215	B321	SEE H290		170	C147	5KC35JN10	✓	21	C223B	182TTFW4027	✓	52
A960A	003062.09	✓	215	B322	048S17D2053	✓	165	C148	5KC35JN10X	✓	21	C223-(GE)	SEE CG223		24
A961	111A271P11	✓	215	B330	SEE C1160		25,167	C150	SEE C150A		40	C224	SEE C1224		52
A962	52D310822ACP1	✓	215	B331	SEE C420		167	C150A	145TTDR14088	✓	40	C225	SEE C225A		52
A963	52D311819ABP1	✓	215	B332	056B17D5701		167	C152	SEE C152A		40	C225A	213TTFW14045	✓	52
A964	52A103486G1	✓	215	B334	SEE C475		167	C152A	184TTDW14078		40	C226	SEE C226A		52
A965	111A271P113	✓	212	B335	056B17D5703	✓	167	C153	5KC36LN30	✓	21	C226A	215TTFW14041	✓	52
A1000	KIT 180-210 TERM BLK	✓	208	B336	056C17D5347	✓	25,167	C154	5KC36LN30X	✓	21	C227	SEE C227A		52
A1001	KIT 250-320 TERM BLK	✓	208	B337	056C17D5348	✓	167	C155	SEE C155A		40	C227A	254TFL14037	✓	52
A1002	KIT 360 TERM BLK	✓	208	B338	056C17D5349	✓	167	C155A	254TTDX14089		40	C230	143TFR5333		51
A1003	KIT 400-445 TERM BLK	✓	208	B348	SEE 4392		166	C156	SEE C156A		40	C230A	143TFR4333		51
A1004	KIT 447/9 TERM BLK	✓	208	B350	SEE C486		167	C156A	256TTDX14087		40	C230-(GE)	SEE CG230		24,167
A1209	KIT 250TCL-R	✓	206	B352	056B17D5331	✓	25,167	C158	5KC36LN7	✓	21	C231	145TFR5340		51
A1287	KIT 280TCDC-A	✓	205	B353	056B17D67	✓	167	C159	5KC36LN7X	✓	21	C231A	145TFR4340		51
A1297	KIT BRK-3 575	✓	209	B380	SEE H209		170	C162	SEE C162A		40	C231-(GE)	SEE D1113		24,167
A1298	KIT BRK-6 575	✓	209	B381	SEE H214		170	C162A	145TTDR14087		40	C232	145TFR5341		51
A1299	KIT BRK-10 575	✓	209	B383	SEE H171		165	C162-(GE)	SEE G1098		21	C232A	145TFR14048		51
A1301	KIT BRK-3 208-230/460	✓	209	B384	SEE H172		165	C163	SEE C123B		40	C232-(GE)	SEE CG232		24
A1302	KIT BRK-6 208-230/460	✓	209	B387	SEE H173		166	C164	5KC37NN15	✓	21	C235	5KC49PN0155	✓	24,167
A1303	KIT BRK-10 208-230/460	✓	209	B388	SEE H174		166	C167	5KC49GN0010	✓	21	C236	SEE C236A		52

## Catalog Number/Model Number

CAT. NO.	MODEL NO.	STOCK	PAGE NO.	CAT. NO.	MODEL NO.	STOCK	PAGE NO.	CAT. NO.	MODEL NO.	STOCK	PAGE NO.	CAT. NO.	MODEL NO.	STOCK	PAGE NO.
C236A	145TTFR4307	✓	52	C321A	145TTGN4337	✓	77	C380	SEE C380B		54	C661	5KC46GN0569Y	✓	29
C236-(GE)	SEE CG236		24	C322	SEE C322A		77	C380B	184TTFW16051	✓	54	C662	5KC49SN2418U	✓	30
C237	SEE C237A		52	C322A	145TTGN4338	✓	77	C381	182TTFR4320	✓	54	C663	5KC49NN2419Y	✓	30
C237A	215TTFW14022	✓	52	C323	SEE C323A		77	C381B	182TTFW16021	✓	54	C664	5KC36LN4003Y	✓	29
C238	SEE C238B		52	C323A	182TTGN4068	✓	77	C381-(GE)	SEE CG381		22	C683	5KC36LN84X	✓	121
C238B	184TTFW14021	✓	52	C324	SEE C324A		77	C382	SEE C382B		54	C702	5KC38RN4153Y	✓	21
C239-(GE)	SEE CG239		25	C324A	184TTGN4072	✓	77	C382B	182TTFW16030	✓	54	C703	5KC49RN2520Y	✓	22
C242	5KC32GN9	✓	29	C325	SEE C325A		77	C382-(GE)	SEE CG382		186	C704	5KC49PN2521Y	✓	22,183
C243	5KC32GN9X	✓	29	C325A	213TTGN4067	✓	77	C383	SEE C383A		54	C732-(GE)	SEE CG732		121
C247	5KC32GN13	✓	168	C326	SEE C326A		77	C383A	182TTFW4345		54	C806	5KC49PN0281X	✓	168
C248	5KC49PN3036	✓	29	C326A	215TTGN4065	✓	77	C383B	182TTFW16027	✓	54	C847	5KC37NN115X	✓	121
C250	SEE C250A		51	C327	SEE C327A		77	C383-(GE)	SEE CG383		186	C855	5KC49SN2156X	✓	31
C250A	145TTFR4378	✓	51	C327A	254TTGN14042	✓	77	C384	SEE C384A		54	C878	5KCR49TN2164T	✓	121
C250-(GE)	SEE G1312		29	C328	SEE C328A		77	C384A	213TTFW16078	✓	54	C1081	5KC39EN2553X	✓	120
C251	SEE C251A		51	C328A	256TTGN14044	✓	77	C384-(GE)	SEE CG384		186	C1082	5KC39HN2554X	✓	120
C251A	---		51	C328-(GE)	SEE J1025		121,172	C385	SEE C385B		54	C1083	5KC33MN2555X	✓	120
C251-(GE)	SEE CG251		29	C329	5KC37FN65X	✓	121	C385B	184TTFW16006	✓	54	C1084	5KC39SN2810X	✓	120
C252	SEE C252A		51	C330	5KC36JN268X	✓	121,172	C386	SEE C386B		54	C1085	5KCR39SN2557X	✓	120
C252A	---		51	C331	5KC36JN269X	✓	121	C386A	SEE C386B		54	C1086	5KCR39UN2558X	✓	120
C252-(GE)	SEE G1316		29	C332	5KC39NN50X	✓	121,172	C386B	184TTFW16027	✓	54	C1087	5KC39EN2500X	✓	120
C253	SEE C253A		52	C333	5KC39QN3219X	✓	121	C387	184TTFR4345	✓	54	C1088	5KC39HN2501X	✓	120
C253A	213TTFW14081	✓	52	C334	5KC39RN44X	✓	121,172	C387A	184TTFW4345	✓	54	C1089	5KC33MN2502X	✓	120
C254	SEE C254A		52	C335	5KC39RN45X	✓	121	C387B	184TTFW16029	✓	54	C1090	5KC39SN2812X	✓	120
C254A	215TTFW14084	✓	52	C336	5KC49NN2140X	✓	121,172	C388	SEE C388A		54	C1091	5KCR39SN2504X	✓	120
C254-(GE)	SEE G1330		29	C337	5KC49NN2167X	✓	121	C388A	215TTFW16079	✓	54	C1092	5KCR39UN2505X	✓	120
C255	SEE C255A		52	C338	5KC49TN2141X	✓	121,172	C389	SEE C389A		55	C1104	SEE C104B		40
C255A	254TTF14078	✓	52	C339	5KC49TN2170X	✓	121	C389A	213TTFW16008	✓	55	C1105	SEE C105B		40
C255-(GE)	SEE G1331		29	C340	5KCR48TN2142T	✓	121,172	C390	SEE C390A		55	C1123	SEE C123B		40
C256	SEE C256A		52	C341	5KCR48TN2174T	✓	121	C390A	213TTFW16035	✓	55	C1152	5KC39QN3220X	✓	24,167
C256A	256TTFNA14086	✓	52	C349	5KC36LN166X	✓	31	C391	213TTFW4345		55	C1153	5KC49GN0022X	✓	24,167
C257-(GE)	SEE C1333		29	C351	5KC49NN2133X	✓	31	C391A	213TTFW16036	✓	55	C1154	5KC38NN413X	✓	24,167
C260	SEE C223B		52	C352	5KC49NN2135X	✓	121	C392	SEE C392A		55	C1155	5KC38NN410X	✓	24,167
C260-(GE)	SEE CG260		29	C354	5KC35JN70X	✓	27	C392A	215TTFW16005	✓	55	C1156	5KC46LN0149X	✓	24,167
C261	5KC42GN0014	✓	29	C355	SEE G230		27	C393	SEE C393A		55	C1157	5KC39RN383X	✓	24,167
C262	5KC42GN0014X	✓	29	C356	5KC36LN83X	✓	27	C393A	215TTFW16041	✓	55	C1158	5KC49PN0164X	✓	24,167
C264	5KC49UN6065	✓	29	C358	SEE G234		27	C393-(GE)	SEE CG393		23	C1159	5KC49RN2152T		25,167
C268	5KC46PN0015	✓	29	C359	5KC49GN0009X	✓	27	C394	215TTFW4345		55	C1160	5KCR49SN0150X	✓	25,167
C269	5KC46PN0015X	✓	29	C361	SEE C361A		75	C394A	215TTFW16042		55	C1161	5KCR49RN2148T	✓	25,167
C271	5KCR48WN6066	✓	29	C361A	143TTGN6551	✓	75	C400	145TTFR5382	✓	98	C1162	SEE B352		25,167
C273	5KC49NN2130X	✓	30	C361-(GE)	SEE CG361		27	C401	145TTFR5360	✓	98	C1168	5KC36GN2507X	✓	120
C274	5KC49NN2130Y	✓	30	C362	SEE C362A		75	C402	184TTL7084	✓	98	C1169	5KC36MN2508X	✓	120
C275	5KC49TN0034	✓	30	C362A	145TTGN6536	✓	75	C403	145TTFR5359	✓	98	C1170	5KC38PN2509X	✓	120
C276	5KC49TN0034X	✓	30	C362-(GE)	SEE CG362		27	C404	184TTL7083	✓	98	C1171	5KC38SN2510X	✓	120
C281	145TBF5337		32	C363	SEE C363A		75	C405	182TTL7034	✓	98	C1172	5KCR39UN2511X	✓	120
C281-(GE)	SEE G1376		30	C363A	145TTGN6549	✓	75	C406	184TTL7041	✓	98	C1173	5KCR39UN2512X	✓	120
C282	145TBF5305		32	C363-(GE)	SEE CG363		27	C407	213TTL7034	✓	98	C1187	5KC49NN0224X	✓	24
C282-(GE)	SEE G1377		30	C364	SEE C364A		75	C408	215TTL7050	✓	98	C1203	SEE C203B		52
C284	145TBF5306		32	C364A	182TTGN6569	✓	75	C419	5KC49PN3027X	✓	25,167	C1204	SEE C204B		52
C284-(GE)	SEE G1392		30	C365	SEE C365A		75	C420	5KCR49PN3011	✓	25,167	C1223	182TTFW7634	✓	52
C289	5KC42GN0309X	✓	168	C365A	184TTGN6575	✓	75	C431	5KC36LN18	✓	21	C1224	184TTFW8641	✓	52
C292	5KC49TN0285X	✓	168	C366	SEE C366A		75	C444	5KC36LN144X	✓	32	C1238	184TTFW8617	✓	52
C295	5KC49TN0033	✓	30	C366A	213TTGN6528	✓	75	C445	5KC49NN2132X	✓	32	C1252	5KC49PN6070	✓	21
C297	5KCR48WN0292	✓	30	C366-(GE)	SEE G1511		31	C446	5KC42GN0018X	✓	31	C1258	5KC49PN6051	✓	24
C301	SEE C301A		77	C367	SEE C367A		75	C449	5KC37NN160	✓	23	C1263	5KC48UN6073	✓	21
C301A	143TTGN4020		77	C367A	215TTGN4028	✓	75	C457	5KC37NN14T	✓	24	C1264	5KC48UN6052	✓	24
C302	SEE C302A		77	C367-(GE)	SEE G1513		31	C459	5KC37MN96	✓	21	C1269	5KC49SN2537Y	✓	28
C302A	145TTGN4022		77	C368	SEE C368A		75	C460	5KC36LN19X	✓	24	C1270	5KC49ZN2539Y	✓	28
C303	SEE C303A		77	C368A	182TTGN6536	✓	75	C462	5KC33KN19	✓	29	C1273	5KC49SN8060T	✓	155
C303A	182TTGN4315	✓	77	C368-(GE)	SEE G1515		31	C465	5KC39QN3218X	✓	121	C1274	5KCR49TN8058T	✓	155
C304	SEE C304A		77	C369	SEE C369A		75	C466	5KCR49TN2155T	✓	31	C1275	5KCR49ZN8061T	✓	155
C304A	184TTGN4313	✓	77	C369A	184TTGN6537	✓	75	C474	5KCR49PN3011X	✓	25,167	C1285	SEE N559		105
C305	213TTGS14015	✓	77	C369-(GE)	SEE G1517		31	C475	5KCR49SN3009	✓	25,167	C1286	SEE N541		105
C306	215TTGS14020	✓	77	C370	SEE C370A		75	C476	5KCR49SN3010	✓	25,167	C1287	SEE N542		105
C307	SEE C307A		77	C370A	213TTGN6536	✓	75	C486	5KCR49PN3012X	✓	25,167	C1288	SEE N543		105
C307A	254TTGP14013	✓	77	C370-(GE)	SEE G1519		31	C548	5KC49PN6051X	✓	24	C1289	SEE N544		105
C308	SEE C308A		77	C371	SEE C371A		75	C552	5KC48UN6052X	✓	24	C1290	SEE N545		105
C308A	256TTGN14011	✓	77	C371A	215TTGN16534	✓	75	C636	SEE S117		26	C1291	5KC46GN0075U	✓	100
C320	SEE C320A		77	C371-(GE)	SEE G1531		31	C646	5KC36PN169X	✓	34	C1292	5KC46UN0076U	✓	100
C320A	143TTGN4062	✓	77	C375	5KC42GN0066	✓	32	C659	5KCR48WN0566Y	✓	30	C1293	5KCR49PN0077U	✓	100
C321	SEE C321A		77	C376	5KC49TN0067	✓	32	C660	5KC49TN0568Y	✓	30	C1294	5KCR49UN0079U	✓	100

# Index

## Catalog Number/Model Number

CAT. NO.	MODEL NO.	STOCK	PAGE NO.	CAT. NO.	MODEL NO.	STOCK	PAGE NO.	CAT. NO.	MODEL NO.	STOCK	PAGE NO.	MODEL NO.	CAT. NO.	STOCK	PAGE NO.
C1295	5KCR49WN0295U	✓	100	CG236	5KC49PN0155X	✓	24	E002	184TFFC6081	✓	57	E153A	182TTDW4304	✓	126
C1296	SEE G212		27	CG239	5KCR49SN0012X	✓	25	E003	SEE GT1111		61	E154	182TTDR4123		126
C1297	SEE G256		27	CG251	5KC32GN19X	✓	29	E004	SEE GT1114		61	E155	184TTDR4140		126
C1298	5KC46NN0758Y	✓	21	CG260	5KC37RN35	✓	29	E005	254TFFC6081	✓	57	E156	184TTDR4146		126
C1299	5KCR48WN0756Y		22,183	CG361	5KC46LN0159	✓	27	E006	256TFFC6081	✓	58	E157	184TTDR4141		126
C1302	5KCR49SN0042S	✓	102	CG362	5KC46LN0159X	✓	27	E007	SEE GT1123		61	E158A	184TTDW4135	✓	126
C1303	5KCR46NN0264T	✓	102	CG363	5KC49PN0163X	✓	27	E008	286TFFC6081	✓	58	E159	184TTDR4147		126
C1314	5KCR49PN0492S	✓	102	CG381	5KCR49WN0270T	✓	22	E009	SEE GT1129		62	E160	184TTDR4115		126
C1315	5KCR49SN0493S	✓	102	CG382	5KC35GNA488	✓	186	E010	326TFFC6081	✓	59	E161	184TTDR4121		126
C1333	5KC49PN6062	✓	29	CG383	5KC35JNA489	✓	186	E011	324TSTFC6006	✓	59	E162	184TTDR4116		126
C1336	5KC33FN4180X	✓	121	CG384	5KC35JNA489Y	✓	186	E012	364TFFC6081	✓	59	E163A	184TTDW4110	✓	126
C1380	SEE C380B		54	CG393	5KC36MN20	✓	23	E013	326TSTFC6006	✓	59	E164	184TTDR4122		126
C1381	SEE C381B		54	CG732	5KC39RN114T	✓	121	E014	365TFFC6081	✓	59	E165	213TTDW4042		127
C1382	SEE C382B		54	D010	056B34D2029	✓	21,183,189	E015	364TSTFC6006	✓	59	E166	213TTDW4041		127
C1385	SEE C385B		54	D012	SEE 9035		23,183	E016	365TSTFC6006	✓	59	E167	213TTDW4033		127
C1404	5KC49UN6067	✓	31	D013	SEE 9036		22,183	E095	143TTDR14004		125	E168	213TTDW4048	✓	127
C1405	5KC35MN145	✓	32	D014	SEE 9031		21,183	E096	145TTDR4317	✓	125	E169	213TTDW4038		127
C1412	5KCR49WN6078		32	D015	SEE 9032		21,183,189	E097	182TTDW14029	✓	126	E170	213TTDW4009		127
C1419	5KC33FN31	✓	31	D017	056B34D5302	✓	22,183	E098	182TTDW4006	✓	126	E171	213TTDW4010		127
C1420	5KC36LN144	✓	32	D018	SEE C704		22,183	E100	143TTDR4035	✓	125	E172	213TTDW4008		127
C1422	5KC48UN6072	✓	27	D107	048S17D2017	✓	165	E102	145TTDR4034	✓	125	E173	213TTDW4023	✓	127
C1423	5KC49MN6063	✓	31	D110	SEE C1152		24,167	E104	145TTDR4060	✓	125	E174	213TTDW4007		127
C1424	5KC49SN2158	✓	31	D111	056C17D2079	✓	24,167	E105	145TTDR4303		126	E175	215TTDW4041		127
C1425	5KC49PN0283	✓	32	D113	SEE D1113		24,167	E106A	182TTDW4033	✓	126	E176	215TTDW4042		127
C1458	5KC46GN0251	✓	186	D114	SEE C1158		24,167	E107A	182TTDW4002	✓	126	E177	215TTDW4043		127
C1459	5KC46GN0251Y	✓	186	D115	056B34D2027	✓	25,167	E108	184TTDR4034	✓	126	E178	215TTDW4048	✓	127
C1460	5KC46LN0252	✓	186	D116	SEE C1161		167	E109A	184TTDW14001	✓	126	E179	215TTDW4032		127
C1461	5KC46LN0252Y	✓	186	D117	SEE C1155		24,167	E110	213TTDW4047	✓	127	E180	215TTDW4008		127
C1462	5KC39HN2888X	✓	120	D118	056C34D2106	✓	24,167	E111	213TTDW4022	✓	127	E181	215TTDW4009		127
C1463	5KC33MN2889X	✓	120	D119	048C17D2055	✓	167	E112	215TTDW4047	✓	127	E182	215TTDW4010		127
C1464	5KC39SN2890X	✓	120	D127	SEE 4305		165	E113	215TTDW4022	✓	127	E183	215TTDW4023	✓	127
C1465	5KCR39SN2891X	✓	120	D129	SEE 4306		165	E114A	254TTDX14062	✓	127	E184	215TTDW4007		127
C1466	5KCR39UN2892X	✓	120	D143	048S17D2086	✓	166	E115	143TTDR4040		125	E185	254TTDX4343		127
C1467	5KC37NN3544T	✓	155	D145	SEE H167		166	E116	143TTDR4047		125	E186	254TTDX4344		127
C1468	5KC49NN2081T	✓	155	D149	056S17D2050	✓	166	E117	143TTDR4041		125	E187	254TTDX4345		127
C1469	5KC49NN0253	✓	186	D162	048S17D2087	✓	166	E118	143TTDR4034	✓	125	E188	254TTDX4039	✓	127
C1474	5KC37LN502Y	✓	21	D163	048S17D2088	✓	166	E119	143TTDR4046		125	E190	254TTDX4007		127
C1475	5KC37NN501Y	✓	21	D164	SEE 4338		166	E120	143TTDR4016		125	E191	254TTDX4006	✓	127
C1477	5KC49PN2144Y	✓	22	D180	048S17D7204		165	E121	143TTDR4022		125	E192	254TTDX4019		127
C1478	5KCR49SN3009X	✓	25,167	D181	048S17D7205	✓	166	E122	143TTDR4017		125	E193	254TTDX4015		127
C1479	5KCR48TN3084X	✓	25,167	D311	056C34F5301	✓	33	E123	143TTDR4009	✓	125	E194	254TTDX4020		127
C1480	5KC49PN0161U	✓	21,183,189	D312	056C34F5302	✓	33	E124	143TTDR4024		125	E195	254TTDX4024		127
C1483	5KC46LN0254X		26	D313	056C34F5303	✓	33	E125	145TTDR4040		125	E197	256TTDX4075	✓	128
C1489	5KC46PN0359Y	✓	186	D314	056B34F5326	✓	33	E126	145TTDR4072		125	E198	256TTDX4326		128
C1801	5KC49MN6384X	✓	34	D315	056B34F5327	✓	33	E127	145TTDR4041		125	E199	256TTDX4329		128
C1802	SEE G650		34	D316	056B34F5328	✓	33	E128	145TTDR4035	✓	125	E202-P	184TTFN16056	✓	57
C1803	5KC49HN0719X	✓	34	D390	056T34T5303	✓	53	E129	145TTDR4047		125	E203-P	213TTFN16326	✓	57
C1804	SEE G651		34	D391	056T34F5301	✓	53	E130	145TTDR4015		125	E204-P	215TTFN16057	✓	58
C1805	SEE G652		34	D392	056T34F5302	✓	53	E131	145TTDR4021		125	E205	254TTFNA6026		58
C1806	SEE G653		34	D393	056T34F5303	✓	53	E132	145TTDR4016		125	E205-P	254TTFNA16074	✓	58
C1807	5KC49QN0716X	✓	34	D394	056T34F5304	✓	54	E133	145TTDR4010	✓	125	E206	256TTFNA6026	✓	58
C1808	SEE G654		34	D395	056T34F5305	✓	54	E134	145TTDR4022		125	E206-P	256TTFNA16070	✓	58
C1809	5KC49SN6375X	✓	34	D396	056T34F5306	✓	54	E135	145TTDR4066		125	E207	284TTFNA6026	✓	58
C1810	5KC49QN4559X	✓	34	D400	056C17F5352	✓	97	E136	145TTDR4046		125	E207-P	284TTFNA16065	✓	58
C1811	SEE G659		34	D401	056C17F5353	✓	97	E137	145TTDR4067		125	E208	286TTFNA6026	✓	58
C1812	SEE G853		35	D402	056C17F5354	✓	97	E138	145TTDR4051	✓	125	E208-P	286TTFNA16070	✓	58
C1813	SEE G854		35	D403	056C17F5355	✓	97	E139	145TTDR4073		125	E209	324TTFS6026	✓	59
C1814	5KC49HN2509X	✓	35	D404	056B17F5330	✓	97	E140	145TTDR4115		126	E209-P	324TTFS16062	✓	59
C1815	SEE G855		35	D450	056T17F5348	✓	98	E141	145TTDR4121		126	E210	326TTFS6026	✓	59
C1816	5KC49QN0718X	✓	35	D451	056T11F5325	✓	98	E142	145TTDR4307		126	E210-P	326TTFS16068	✓	59
C1817	5KC49SN6380X	✓	35	D452	056T17F5349	✓	98	E143	145TTDR4110		126	E211	364TTFS6036	✓	59
C1818	5KC49MN6379X	✓	35	D453	056T11F5326	✓	98	E144	145TTDR4025		126	E212	365TTFS6036	✓	59
C1904	SEE Z128		99	D454	056T17F5350	✓	98	E145	182TTDR4140		126	E213	405TTFS6036	✓	59
C1909	5KCR49ZN0785S	✓	102	D455	056T11F5327	✓	98	E146	182TTDR4146		126	E214	444TTFS6036	✓	60
CG105	5KC35JN27Y	✓	23	D456	056T17F5357	✓	98	E147	182TTDR4036		126	E215	445TTFN6036	✓	60
CG111	5KC37LN91	✓	23	D457	056T17F5358	✓	98	E148A	182TTDW4135	✓	126	E216	182TTTS6001	✓	57
CG201	5KC35JN12X	✓	24	D1113	5KC46LN0158X	✓	24,167	E149A	182TTDW4147		126	E218	213TTTS6001	✓	57
CG223	5KC49GN0001X	✓	24	E12D4	5KS49HN4077	✓	36	E150	182TTDR4116		126	E220	254TTFNA6001		58
CG230	5KC46LN0158	✓	24,167	E34D4	5KS46MN4078	✓	36	E151	182TTDR4122		126	E221	256TTFNA6001	✓	58
CG232	5KCR49WN6077	✓	24	E001	SEE GT1105		61	E152	182TTDR4117		126	E222	284TSTFNA6001	✓	58

## Catalog Number/Model Number

CAT. NO.	MODEL NO.	STOCK	PAGE NO.	CAT. NO.	MODEL NO.	STOCK	PAGE NO.	CAT. NO.	MODEL NO.	STOCK	PAGE NO.	CAT. NO.	MODEL NO.	STOCK	PAGE NO.
E223	286TSTFNA6001	✓	58	E290	SEE N310		106	E402	SEE E402A		69	E567-P	324TTGS16541	✓	80
E224	324TSTFS6001	✓	59	E291	449TTFS16334		60	E402A	365TTFS16592		69	E568	SEE E568A		80
E225	326TSTFS6001	✓	59	E292	449TTFS6065		60	E403	404TTFS6592		69	E568A	364TTGS16577	✓	80
E226	364TSTFS6001	✓	59	E293	449TTFS16333		60	E404	405TTFS6587		69	E569	326TSTGS6501	✓	80
E227	365TSTFS6001	✓	59	E294	SEE N642		107	E405	SEE E405A		70	E570	326TTGS6532	✓	80
E228	405TSTFS6001	✓	59	E295	SEE N644		107	E405A	444TTFN16582		70	E570-P	326TTGS16546	✓	80
E229	444TSTFS6001	✓	60	E296	SEE N646		107	E406	445TTFN6590		70	E571	365TTGS16577	✓	80
E230	445TSTFN6001	✓	60	E297-(GE)	SEE N647		107	E407	445TTFN6591		70	E572	364TSTGS6506	✓	80
E235	254TTFNA6076	✓	57	E302-(GE)	SEE N566		108	E408	449TTFS6582		70	E573	SEE E573A		80
E236	256TTFNA6076	✓	58	E303	182TTTS6030		57	E448	445TTFN6587	✓	70	E573A	364TTGS16536	✓	80
E237	284TTFNA6076	✓	58	E303-(GE)	SEE N567		108	E449	445TSTFN6505	✓	70	E574	404TTGS6588	✓	80
E238	286TTFNA6076	✓	58	E304-(GE)	SEE N622		108	E450	445TTFN6540		70	E575	365TSTGS16503	✓	81
E239	324TTFS6076	✓	58	E305-(GE)	SEE N569		108	E453	326TSTFS6536		69	E576	SEE E576A		81
E240	326TTFS6076	✓	59	E306	215TTFS6030		58	E454	364TSTFS6526		69	E576A	365TTGS16540	✓	81
E241	SEE E241A		59	E306-(GE)	SEE N599		108	E455	365TSTFS6526	✓	69	E577	405TTGS6589	✓	81
E241A	364TTFS16083	✓	59	E307	254TTFNA6030	✓	58	E456	405TSTFS6526	✓	70	E578	405TSTGS6503		81
E242	SEE E242A		59	E307-(GE)	SEE N623		108	E457	444TSTFS6526	✓	70	E580A	444TTGN16580	✓	81
E242A	365TTFS16083	✓	59	E308	256TTFNA6030	✓	58	E458	445TSTFN6526	✓	70	E582A	444TTGN16532	✓	81
E243	404TTFS6086	✓	59	E308-(GE)	SEE N601		108	E459	445TSTFN6528	✓	70	E583	445TTGN6597		81
E244	405TTFS6086	✓	59	E309	284TTFNA6030	✓	58	E461	143TTN6563	✓	67	E584	445TSTGN16505		81
E246	445TTFN6086	✓	60	E309-(GE)	SEE N602		108	E462	145TTN6584		67	E585	445TTGN6542	✓	81
E247	445TTFN6038	✓	60	E310	286TTFNA6030	✓	58	E463	143TTN6502		67	E588	445TTGN6538		81
E250	5KCR46JN0083Y	✓	28	E310-(GE)	SEE N626A		108	E464	145TTN6834	✓	67	E591	449TTGS16537		81
E251	5KCR46JN0084	✓	27	E311	324TTFS6030	✓	59	E465	182TTTS6578		67	E594	405TTGS6548	✓	81
E252	5KCR46JN0083X	✓	28	E311-(GE)	SEE EG311		108	E466	145TTN6521		67	E595	449TSTGS14003		81
E253	5KCR46JN0085	✓	21	E312	326TTFS6030	✓	59	E467	145TTN6835	✓	68	E601	182TTTS6501	✓	68
E254	5KCR46JN0086X	✓	24	E312-(GE)	SEE N605		108	E468	184TTTS6582	✓	68	E602	184TTFS6501	✓	68
E255	5KCR46JN0087Y	✓	32	E313	364TTFS6040	✓	59	E470	182TTTS6538	✓	68	E603	213TTTS6501	✓	68
E256	5KCR46JN0088	✓	31	E314	405TTFS6040	✓	59	E471	213TTFS6594	✓	68	E604	215TTFS6501	✓	68
E257	5KCR46JN0087X	✓	32	E315	365TTFS6040	✓	59	E472	184TTFS6810	✓	68	E605	254TTFNA6501	✓	68
E258	5KCR46JN0089	✓	29	E316	SEE E316A		60	E473	184TTFS6844	✓	68	E606	256TTFNA6501	✓	69
E259	5KCR46MN0090Y	✓	28	E316A	444TTFN6044		60	E474	215TTFS6881	✓	68	E607	284TSTFNA6501	✓	69
E260	5KCR46MN0091	✓	27	E317	445TTFN6037		60	E475	213TTTS6502	✓	68	E608	286TSTFNA6501	✓	69
E261	5KCR46MN0090X	✓	28	E319	324TSTFS6005		59	E476	213TTFS6531	✓	68	E609	324TSTFS6501	✓	69
E262	5KCR46MN0092	✓	21	E320	326TSTFS6005		59	E477	254TTFNA6590	✓	68	E610	326TSTFS6501	✓	69
E263	5KCR46MN0054X	✓	24	E321	364TSTFS6005		59	E478	215TTFS6807	✓	68	E611	364TSTFS6501	✓	69
E264	5KCR46MN0055Y	✓	32	E322	365TSTFS6002		59	E479	215TTFS6527	✓	68	E612	365TSTFS6501	✓	69
E265	5KCR46MN0093	✓	31	E323	405TSTFS6005		59	E480	256TTFNA6596	✓	68	E613	405TSTFS6501	✓	70
E266	5KCR46MN0055X	✓	32	E324	444TSTFS16002		60	E481	254TTFNA6515	✓	68	E614	444TSTFS6501	✓	70
E267	5KCR46MN0094	✓	29	E326	445TTFN6039		60	E482	254TTFNA6529	✓	68	E615	445TSTFN6501	✓	70
E268	5KCR49PN0095Y	✓	28	E327	444TTFN16577		70	E483	284TTFNA6876	✓	68	E616	182TTTS6526	✓	68
E269	5KCR49PN0096	✓	27	E328	444TTFN6086	✓	59	E484	256TTFNA6523	✓	69	E617	184TTFS6526	✓	68
E270	5KCR49PN0095X	✓	28	E342	445TSTFN16004	✓	60	E485	256TTFNA6529	✓	69	E618	213TTFS6526	✓	68
E271	449TSTFS6003		60	E345	449TTFS16534		70	E486	286TTFNA6876		69	E619	215TTFS6526	✓	68
E271-(GE)	SEE EG271		61	E351	143TTN6001	✓	56	E488	284TTFNA6837	✓	69	E620	254TTFNA6526	✓	68
E272	449TSTFS6002		60	E353	145TTN6001	✓	57	E490	286TSTFNA6804	✓	69	E620-P	254TTFNA16838	✓	68
E272-(GE)	SEE EG272		24	E362	---		70	E491	286TTFNA6570	✓	69	E621	256TTFNA6526	✓	69
E273	449TSTFS6001		60	E363	5013LSTFS6595		70	E493	405TSTFS6502		70	E621-P	256TTFNA16855	✓	69
E273-(GE)	SEE EG273		32	E364	5011LSTFS16031		70	E494	444TSTFS6505		70	E622	284TTFNA6526	✓	69
E274	5KCR49PN0100	✓	31	E365	---		70	E495	445TSTFN6502		70	E622-P	284TTFNA16851	✓	69
E275	5KCR49PN0099X	✓	32	E366	5011LSTFS16033		70	E496	445TSTFN6506		70	E623	286TTFNA6526	✓	69
E276	449TTFS6038		60	E369	---		70	E500	254TTGN6576	✓	80	E623-P	286TTFNA16847	✓	69
E276-(GE)	SEE EG276		29	E373	143TTFN6576		67	E501	256TTGN6576	✓	80	E624	324TTFS6526	✓	69
E277	449TTFS6037		60	E374	143TTFN6526		67	E502	254TTGN6507	✓	80	E624-P	324TTFS16860	✓	69
E277-(GE)	SEE EG277		28	E375	143TTFN6563		67	E503	254TTGN6531	✓	80	E625	326TTFS6526	✓	69
E278	SEE G256		27	E376	143TTFN16539		67	E503-P	254TTGN16549	✓	80	E625-P	326TTFS16844	✓	69
E280	5KCR48UN0104	✓	21	E377	143TTFN6501		67	E504	284TTGN6576	✓	80	E626	364TTFS6536	✓	69
E281	5KCR48UN0105X	✓	24	E378	143TTFN6502		67	E505	256TTGN16509	✓	80	E627	365TTFS6536	✓	69
E282	449TTFS6088	✓	60	E379	143TTFN6505		67	E506	256TTGN6531	✓	80	E628	405TTFS6536	✓	70
E282-(GE)	SEE EG282		32	E380	182TTFS6576		67	E506-P	256TTGN16552	✓	80	E629	444TTFS6536	✓	70
E283	449TTFS6087		60	E382	145TTFN6501		67	E507	286TTGN16577	✓	80	E630	445TTFN6536	✓	70
E283-(GE)	SEE EG283		31	E383	145TTFN6521		67	E546	284TSTGN6503	✓	80	E631	445TTFN6538	✓	70
E284	449TTFS6390		60	E386	145TTFN6835		68	E547	284TTGN6533	✓	80	E632	182TTFS6576	✓	67
E284-(GE)	SEE EG284		32	E388	184TTFS6576		68	E547-P	284TTGN16550	✓	80	E633	184TTTS6576	✓	68
E285	5KCR49UN0108	✓	30	E390	182TTFS6501		68	E563	286TSTGN6501	✓	80	E634	213TTFS6576	✓	68
E286	5K549HN4595	✓	106	E392	182TTFS6505		68	E564	286TTGN6537	✓	80	E635	215TTFS6576	✓	68
E287	445TTFN6040		60	E396	213TTFS6501		68	E564-P	286TTGN16546	✓	80	E636	254TTFNA6576	✓	68
E287-(GE)	SEE N322		106	E400	326TTFS6580		69	E565	326TTGS6578	✓	80	E637	256TTFNA6576	✓	68
E288	SEE N320		106	E401	SEE E401A		69	E566	324TSTGS6501	✓	80	E638	284TTFNA6576	✓	68
E289	445TTFN6087		60	E401A	364TTFS16585		69	E567	324TTGS6529	✓	80	E639	286TTFNA6576	✓	69

# Index

## Catalog Number/Model Number

CAT. NO.	MODEL NO.	STOCK	PAGE NO.	CAT. NO.	MODEL NO.	STOCK	PAGE NO.	CAT. NO.	MODEL NO.	STOCK	PAGE NO.	MODEL NO.	CAT. NO.	STOCK	PAGE NO.
E640	324TTF6576	✓	69	E712	SEE U776		44	E771	449TTF6528	✓	70	E819	286TSTFPA4005		50
E641	326TTF6576	✓	69	E713	SEE U778		43	E772	449TTF6527		70	E819A	SEE GT1130		62
E642	SEE E942A		69	E714	SEE U1782		44	E773	449TTF6578	✓	70	E820	SEE GT1029		62
E642A	364TTF16584	✓	69	E715	SEE U758		42	E774	449TTF6577		70	E820A	SEE GT1029		62
E643	SEE E643A		69	E716	SEE U759		42	E776	449TTF16553		70	E821	215TTFW4005		48
E643A	365TTF16591	✓	69	E717	SEE U760		42	E777	—		70	E822	215TTFW4028	✓	48
E644	404TTF6586	✓	69	E718	SEE E1930		42	E780	SEE E780A		44	E823	SEE GT1005		61
E645	405TTF6586	✓	69	E719	SEE E1931		43	E780A	404TSTDS16036	✓	44	E823A	SEE GT1005		61
E646	SEE E646A		70	E720	SEE U763		40	E781	SEE E781A		44	E824	143TTFR4028	✓	47
E646A	444TTFN16581	✓	70	E721	SEE U765		43	E781A	405TSTDS16038	✓	44	E825	143TTTN4028		49
E647	445TTFN6586	✓	70	E722	SEE U722A		43	E782	SEE E782C		44	E826	143TTTC4026	✓	49
E648	143TTTN6576	✓	67	E722A	254TTDX16042	✓	43	E782C	365TSTDS16041	✓	44	E827	SEE E2126		58
E649	143TTTN6526	✓	67	E722A-P	254TTDX16043	✓	43	E783	143TDR5313	✓	37	E828	143TTTN4030		49
E650	145TTTN6576	✓	67	E723	SEE U723A		43	E783A	143TTDR6313	✓	37	E829	145TTTN4076	✓	49
E651	143TTTN6501	✓	67	E723A	256TTDX16032	✓	43	E784	SEE U247		42	E830	143TTFR4003		48
E652	145TTTN6526	✓	67	E723A-P	256TTDX16033	✓	43	E785	145TTDR4078		37	E831	143TTTN4003		49
E653	145TTTN6501	✓	67	E725A	SEE U773		43	E786	256TTDX4013	✓	38	E832	SEE E2103		58
E654	145TTTN6527	✓	68	E725B	SEE U773		43	E787	324TTP4030	✓	39	E833	143TTTN4001	✓	49
E655	184TTF6505	✓	68	E726	SEE U775		44	E788	215TTDW4003	✓	38	E834	SEE E2128		58
E656	213TTTS6505	✓	68	E727	SEE U777		44	E789	SEE E789A		44	E835	143TTTN4005		49
E657	215TTF6505		68	E728	SEE U265		42	E789A	326TSTDP16032	✓	44	E836	145TTFR4029	✓	48
E658	254TTFNA6503		68	E729	SEE E1729		37	E790	326TTP4046		39	E837	145TTTC4026	✓	49
E659	256TTFNA6503	✓	69	E730	SEE U1267		42	E791	SEE E791A		44	E838	145TTFR4038		48
E660	284TSTFNA6502		69	E731	SEE U268		42	E791A	326TSTDR16034	✓	44	E839	145TTTN4035	✓	49
E662	324TSTF6505		69	E732	SEE U269		43	E791A-P	326TTDR16063	✓	44	E840	145TTFR4005		48
E663	326TSTF6502		69	E733	SEE E733A		43	E792	SEE E792A		44	E841	145TTTN4003		49
E664	364TSTF6505		69	E733A	254TTDX16082	✓	43	E792A	444TSTDS16038	✓	44	E842	145TTTN4001	✓	49
E665	365TSTF6502	✓	69	E734	SEE E734A		43	E793	SEE E793A		43	E843	145TTFR4007		48
E666	143TTTN6530	✓	67	E734A	256TTDX16078	✓	43	E793A	284TSTDN16031		43	E844	145TTTN4005		49
E667	145TTTN6529		67	E735	SEE U256		43	E794	SEE E794A		43	E845	145TTFR4032	✓	48
E668	145TTTN6530	✓	68	E736	SEE U257		43	E794A	286TSTDN16036		43	E846	145TTTC4027	✓	49
E669	182TTTS6300	✓	68	E737	SEE U798		43	E795	SEE U273		44	E847	145TTFR4039		48
E670	184TTF6530	✓	68	E738	SEE U799		43	E796	SEE U274		44	E848	145TTTN4040	✓	49
E671	213TTF6530	✓	68	E739	SEE U1779		44	E797	SEE U275		44	E849	SEE GT1008		61
E672	215TTF6530	✓	68	E740	SEE U1783		44	E798	143TTDR4006		37	E849A	SEE GT1008		61
E673	254TTFNA6528	✓	68	E741	SEE E922		44	E798A	143TTDR16005	✓	42	E851	143TTTN6505		67
E674	256TTFNA6528	✓	69	E742	SEE E923		44	E799	SEE E1799		37	E852	145TTTN6505		67
E675	284TTFNA6527	✓	69	E743	SEE E924		44	E800	284TTFPA4030		50	E853	182TTTS6505		68
E676	286TTFNA6527	✓	69	E744	SEE E925		44	E800A	284TTF6031	✓	58	E854	449TTF6540	✓	70
E677	324TTF6527	✓	69	E745	445TSDS4037		39	E801	SEE E801A		59	E856	449TTF6564	✓	70
E678	326TTF6527	✓	69	E746	SEE U1927		44	E801A	326STFC6036	✓	59	E901	143TTDR5348	✓	36
E679	364TTF6537	✓	69	E747	SEE U1928		44	E802	SEE E802A		59	E902	145TTDR5632	✓	37
E680	365TTF6537		69	E748	SEE U270		44	E802A	364STFC6026	✓	59	E903	145TTDR5633	✓	37
E681	405TTF6538	✓	70	E749	SEE U271		44	E803	SEE E243		59	E906	213TTDBA4028	✓	38
E682	445TTFN6537		70	E750	SEE U272		44	E804	SEE 804A		59	E907	215TTDW4028	✓	38
E683	215TTF6580		68	E753	SEE U1784		44	E804A	365STFC6026	✓	59	E908	254TTDX4028	✓	38
E684	254TTFNA6578		68	E754	SEE U250		44	E805	365TTF6040		50	E909	256TTDX4027	✓	38
E685	256TTFNA6578		68	E755	SEE U251		44	E805A	365TTF6041	✓	59	E910	284TTP4029	✓	38
E687	449TTF6588	✓	70	E756	SEE U252		44	E806	SEE E244		59	E911	286TTP4027	✓	39
E688	449TTF6587		70	E757	445TSDS4001	✓	39	E807	SEE E228		59	E912	143TTDR5351		37
E690	449TTF6538	✓	70	E758	213TTDW4030		38	E808	SEE E808A		59	E912A	143TTDR16037	✓	42
E691	449TTF6537	✓	70	E759	215TTDW4030	✓	38	E808A	405TSTFS16033	✓	59	E913	SEE E913A		42
E692	449TTF6536	✓	70	E760	254TTDX4030	✓	38	E809	SEE E328		59	E913A	145TTDR16061	✓	42
E694	284TTFNA6580	✓	68	E761	256TTDX4032		38	E810	SEE E810A		60	E914	145TTDR5665		37
E695	286TTFNA6580		69	E762	284TTP4035		38	E810A	444TSTFN16033	✓	60	E914A	145TTDR16062	✓	37, 42
E696	324TTF6577		69	E762A	284TDC6029	✓	43	E811	SEE E811A		60	E915B	182TTDW16029	✓	42
E697	444TTF6540		70	E763	286TTP4034		39	E811A	445TSTFN6026	✓	60	E916B	184TTDW16040	✓	43
E698	449TSTF6502	✓	70	E763A	286TDC6029	✓	43	E812	SEE E342		60	E917	143TTDR4005	✓	37
E699	449TSTF6503	✓	70	E764	324TTP4028		39	E813	SEE E813A		60	E918	184TTDR4178		37
E702	SEE U246		42	E764A	324TTDC6029	✓	44	E813A	445TSTFN16033	✓	60	E919	145TTDR4003		37
E704	SEE GT0012		38	E765	326TTP4048		39	E814	SEE E814A		60	E922	404TDS6060	✓	44
E705	SEE U249A		43	E765A	326TTPC6029	✓	44	E814A	449TTF16094	✓	60	E923	405TTDS6060	✓	44
E706	SEE U764		43	E766	364TDS4040		39	E815	324TTFPA4030		50	E924	444TDS6060	✓	44
E707	SEE U766		43	E766A	365TDS16067		44	E815A	324TTF6031	✓	59	E925	445TDS6060	✓	44
E708	SEE E708A		43	E767	365TDS4041		39	E816	SEE E816A		59	E932	145TTDR4105		37
E708A	254TTDX16010	✓	43	E767A	365TDS16064		44	E816A	324STFC6036	✓	59	E932A	145TTDR16010	✓	42
E709	SEE E709A		43	E768	SEE E768C		44	E817	286TTFPA4030		50	E933	182TTDR4104		38
E709A	256TTDX16006	✓	43	E768C	365TSDS16042	✓	44	E817A	286TTF6031	✓	59	E934	145TTDR4080		37
E710	SEE U772		43	E769	449TSTF6501	✓	70	E818	SEE E818A		58	E934A	145TTDR16077	✓	42
E711	SEE U774		44	E770	449TTF6530	✓	70	E818A	286STFC6036	✓	58	E935	215TTDW4078	✓	38



## Catalog Number/Model Number

CAT. NO.	MODEL NO.	STOCK	PAGE NO.	CAT. NO.	MODEL NO.	STOCK	PAGE NO.	CAT. NO.	MODEL NO.	STOCK	PAGE NO.	CAT. NO.	MODEL NO.	STOCK	PAGE NO.
E936	SEE U280		43	E999A	284TSTFC6036	✓	58	E2105	182TTFW16076	✓	56	EG277	5KCR48UN0102Y	✓	28
E937	SEE 937A		38	E1002	284TTDR16077	✓	43	E2106	145TTFR13002	✓	57	EG282	5KCR49UN0106Y	✓	32
E937A	184TTDW4003		38	E1006	284TTDR16047	✓	43	E2107	145TTFR16035	✓	57	EG283	5KCR49UN0107	✓	31
E938	184TTDR4105		38	E1006-P	284TTDR16048	✓	43	E2108	184TTFW16076	✓	57	EG284	5KCR49UN0106X	✓	32
E938A	184TTDW16027	✓	43	E1008	284TSTDR16003	✓	43	E2109	182TTFW16001	✓	57	EG287	SEE N322		106
E939	213TTDW4003		38	E1009	286TTDR16037	✓	43	E2110	182TTFW16026	✓	57	EG297	SEE N647		107
E950	SEE E2101		58	E1009-P	286TTDR16038	✓	43	E2111	213TTFW16076	✓	57	EG302	SEE N566		108
E951	SEE E2104		58	E1010	286TSTDR16002	✓	44	E2112	184TTFW16001	✓	57	EG303	SEE N567		108
E952	SEE E2107		59	E1704	SEE U1248		43	E2113	184TTFW16026	✓	57	EG304	SEE N622		108
E953	SEE E2110		59	E1705	SEE U249A		43	E2114	215TTFW16076	✓	57	EG305	SEE N569		108
E954	SEE E2113		59	E1719	SEE E1931		43	E2115	213TTFW16001	✓	57	EG306	SEE N599		108
E955	SEE E2116		59	E1724	SEE U771		43	E2116	213TTFW16026	✓	57	EG307	SEE N623		108
E957	SEE E957A		59	E1726	SEE U775		44	E2117	254TTFW16076	✓	57	EG308	SEE N601		108
E957A	365TTFW6037	✓	59	E1727	SEE U777		44	E2118	215TTFW16001	✓	58	EG309	SEE N602		108
E958	SEE E289		60	E1729	SEE U1266		42	E2119	215TTFW16026	✓	58	EG310	SEE N626A		108
E959	SEE E213		59	E1730	SEE U1267		42	E2120	256TTFW16076	✓	58	EG311	5KS49UN4598	✓	108
E960	SEE E960A		59	E1739	SEE U1779		44	E2121	254TTFW16001	✓	58	EG312	SEE N605		108
E960A	364TSTFC6002	✓	59	E1740	SEE U1783		44	E2122	254TTFW16026	✓	58	F10E1	5KC49TN0063Y	✓	99
E961C	284TTFW6027	✓	58	E1768	SEE E768C		44	E2122-P	254TTFW16036	✓	58	F12E1	5KC46GN0050Y	✓	99
E962	SEE E962B		59	E1782	SEE E782C		44	E2123	256TTFW16002	✓	58	F13E1	SEE F101		99
E962B	326TTFW6027	✓	59	E1799	182TTDW4083	✓	37	E2124-P	256TTFW16038	✓	58	F15E1	5KCR48WN0292Y		99
E963	SEE E2112		59	E1904	182TTDW4027	✓	38	E2124	256TTFW16033	✓	58	F3AE1	SEE F103		99
E964	SEE GT1030		62	E1905	184TTDW4027	✓	38	E2125	056T34F16020		56	F100	SEE F105		99
E964A	SEE GT1030		62	E1915	182TTDW4030		38	E2126	143TTFR16040	✓	56	F101	056C17F5324	✓	99
E965	SEE E2124		58	E1916	184TTDW4030	✓	38	E2127	145TTFR16080		56	F102	056C17F5325	✓	99
E966	SEE E966A		59	E1930	182TTDW6030	✓	42	E2128	143TTFR16020		56	F103	056C17F5326	✓	99
E966A	326TTFW6077	✓	59	E1930-P	182TTDW16063	✓	42	E2129	145TTFR16040	✓	56	F104	056C17F5327	✓	99
E967	SEE E2109		59	E1931	184TTDW6031	✓	43	E2130	182TTFW16080	✓	56	F105	056B17F5307	✓	99
E968	SEE E968A		58	E1931-P	184TTDW16061	✓	43	E2131	145TTFR16020		57	F107	SEE C1468		155
E968A	286TTFW6077	✓	58	E1955	SEE E2116		59	E2132	145TTFR16045	✓	57	F108	SEE C1273		155
E969	SEE E2118		58	E1956	SEE E2119		58	E2133	184TTFW16081		57	F109	SEE C1274		155
E970	SEE E2114		59	E1961	SEE E961C		58	E2134	182TTFW16020	✓	57	F110	SEE C1275		155
E971	SEE E971A		59	E1962	SEE E962B		59	E2135	182TTFW16040	✓	57	F120	SEE C1467		155
E971A	324TSTFC6002	✓	59	E1963	SEE E2112		59	E2136	213TTFW16081		57	F131	056C17F5358	✓	32,99
E972	SEE E2115		59	E1967	SEE E2109		59	E2137	184TTFW16020	✓	57	F132	056C17F5912	✓	32,99
E973	SEE E2120		58	E1982	SEE E2105		58	E2138	184TTFW16040	✓	57	F133	056C17F5913	✓	32,99
E974	SEE E2123		58	E1983	SEE E983B		58	E2139	215TTFW16080		57	F134	056C17F5914	✓	32,99
E975	SEE E975A		58	E1984	SEE E984B		59	E2140	213TTFW16020		57	F135	056B17F5584	✓	32,99
E975A	284TSTFC6002	✓	58	E1985	SEE E985B		59	E2141	213TTFW16040	✓	57	F201	SEE HG646		100
E976	SEE E976A		59	E1995	SEE E2108		59	E2142	254TTFW16077		57	F202	SEE C1292		100
E976A	326TSTFC6002	✓	59	E2000	056T34F5940	✓	60	E2143	215TTFW16020		58	F203	SEE C1293		100
E977	SEE E2121		58	E2001	143TTFR5642	✓	60	E2144	215TTFW16040	✓	58	F204	056C17F5357	✓	100
E978	SEE E978A		58	E2001A	143TTFR16053	✓	60	E2145	256TTFW16077		58	F205	056B17F5331	✓	100
E978A	284TTFW6077	✓	58	E2002	145TTFR6078	✓	60	E2146	254TTFW16020		58	F780	5KCP49UN9837S	✓	104
E979	SEE E2102		58	E2003	143TTFR5582	✓	60	E2147	254TTFW16040	✓	58	F781	5KCP49UN9838S	✓	101
E980	SEE E2111		59	E2004	145TTFR6033	✓	60	E2148	256TTFW16020		58	F1201	048C17F11005	✓	100
E981	SEE E230		60	E2004A	145TTFR16331	✓	60	E2149	256TTFW16040	✓	58	F1202	048C17F11006	✓	100
E982	SEE E2105		58	E2005	182TTFW6076	✓	60	E2150	056T34F16001		56	F1203	048C17F11007	✓	100
E983	SEE E983B		58	E2006	145TTFR3002	✓	60	E2151	143TTFR16038	✓	56	F1204	056C17F15537	✓	100
E983B	286TTFW6027	✓	58	E2007	145TTFR6035	✓	60	E2152	145TTFR15581		56	F1205	056B17F15516	✓	100
E984	SEE E984B		59	E2007A	145TTFR16329	✓	60	E2153	143TTFR16001		56	G044	048T17D2000	✓	36
E984B	324TTFW6027	✓	59	E2008	184TTFW6076	✓	60	E2154	145TTFR16038	✓	56	G046	056T17D2128		36
E985	SEE E985B		59	E2009A	SEE E2009		60	E2155	182TTFW16082		56	G047	056T17D2095	✓	36
E985B	364TTFW6037	✓	59	E2009	182TTFW6001	✓	60	E2156	145TTFR16001		57	G061	056T11D5301	✓	36
E986	SEE E215		60	E2010	182TTFW6026	✓	60	E2157	145TTFR16039	✓	57	G062	056T17D2114	✓	36
E987	SEE E214		60	E2011	213TTFW6076	✓	60	E2158	184TTFW16079		57	G063	056T17D2094	✓	36
E988	SEE E988A		59	E2012	184TTFW6001	✓	60	E2159	182TTFW16002	✓	57	G065	056T17D2112	✓	36
E988A	364TTFW6087	✓	59	E2013	184TTFW6026	✓	60	E2160	182TTFW16038	✓	57	G067	056T11D5302	✓	36
E989	SEE E247		60	E2014	215TTFW6076	✓	60	E2161	213TTFW16082		57	G076	SEE C147		21
E991	SEE E991A		59	E2015	213TTFW6001	✓	60	E2162	184TTFW16002	✓	57	G078	048C17D2034	✓	21
E991A	365TSTFC6003	✓	59	E2016	213TTFW6026	✓	60	E2163	184TTFW16038	✓	57	G080	056T34D5301	✓	36
E992	SEE E229		59	E2016A	213TTFW16039	✓	60	E2164	215TTFW16081		57	G082	056T17D2111	✓	36
E993	SEE E993A		59	E2018	215TTFW6001	✓	60	E2201-P	143TTFN16040	✓	56	G084	056T17D2093	✓	36
E993A	365TTFW6087	✓	59	E2019	215TTFW6026	✓	60	E2204-P	145TTFN16046	✓	56	G086	056T17D2110	✓	36
E994	SEE E2106		59	E2019A	215TTFW16047	✓	60	E2207-P	145TTFN16045	✓	57	G088	056T11D5303		36
E995	SEE E2108		59	E2100	056T34F15940	✓	56	E2210-P	182TTFN16047	✓	57	G091	048C34D2025		21
E996	SEE E2122		58	E2101	143TTFR15642	✓	56	EG271	5KCR49PN0097	✓	21	G093	SEE C158		21
E997	SEE E2147		58	E2102	145TTFR16078	✓	56	EG272	5KCR49PN0098X	✓	24	G094	SEE C159		21
E998	256TTFW14030		48	E2103	143TTFR15582	✓	56	EG273	5KCR49PN0099Y	✓	32	G095	056C17D2010	✓	21
E999	SEE E999A		58	E2104	145TTFR16033	✓	56	EG276	5KCR49PN0101	✓	29	G096	SEE C1252		21

# Index

## Catalog Number/Model Number

CAT. NO.	MODEL NO.	STOCK	PAGE NO.	CAT. NO.	MODEL NO.	STOCK	PAGE NO.	CAT. NO.	MODEL NO.	STOCK	PAGE NO.	MODEL NO.	CAT. NO.	STOCK	PAGE NO.
G098	SEE G1098		21	G309	056T34F5333	✓	47	G528	SEE K524		51	G829	056T17G5315	✓	77
G100	056T17D2101	✓	169	G312	SEE G1312		29	G530	SEE C1424		31	G840	056T17G5316	✓	77
G101	SEE K1410		169	G314	056C17F2052	✓	29	G531	SEE G1531		31	G841	056T17G5317	✓	77
G106	056T17D2104	✓	169	G316	SEE G1316		29	G533	056B34F5319	✓	31	G842	056T17E5312		77
G107	SEE K1408		169	G321	SEE K158		47	G534	SEE C1419		31	G843	056T17E5313	✓	77
G109	SEE K381		169	G322	SEE K426		47	G541	SEE K257		51	G844	056T17G5318		77
G114	SEE G1114		24,167	G324	SEE K159		47	G544	SEE K1491		51	G845	056T17G5319	✓	77
G115	SEE G1115		24,167	G326	SEE K160		47	G547	SEE K252		51	G846	056T17G5320	✓	77
G120	SEE K278		169	G327	056T34F5334	✓	47	G548	056T17F5320		51	G852	056C17E5319	✓	35
G122	056T17D5329	✓	169	G328	056T17F2045		47	G549	056T17F5329		51	G853	056C17G5320	✓	35
G126	SEE K1415		169	G329	SEE K161		47	G550	SEE C1405		32	G854	056C34G5311		35
G127	056T17D5332	✓	169	G330	SEE G1330		29	G551	SEE C375		32	G855	056C17G5321	✓	35
G128	SEE K1418		169	G331	SEE G1331		29	G552	SEE C1245		32	G857	056C17G5322	✓	35
G135	056C17D2088	✓	24,167	G332	056C17F2049	✓	29	G553	SEE C376		32	G858	056C34G5316		35
G140	056T17D5345	✓	169	G333	SEE C1333		29	G559	SEE C1420		32	G870	056C17G5323	✓	35
G141	056T17D5346	✓	169	G337	SEE C261		29	G560	SEE K1322		53	G871	056C17G5324	✓	35
G142	056T17D5347	✓	169	G338	SEE C262		29	G561	SEE K1324		53	G872	056C17G5328	✓	35
G143	056T17D5348	✓	169	G339	056C17F2051	✓	29	G562	SEE K258		53	G873	056C34G5314	✓	35
G144	056T17D5349	✓	169	G340	SEE G1340		47	G563	SEE K259		53	G874	056C17G5326	✓	35
G145	056T17D5350	✓	169	G342	SEE K162		47	G564	SEE K260		54	G875	056C34G5315		35
G151	056C17D2025	✓	24,167	G344	SEE K163		47	G565	056T17F2051		53	G876	056C17G5327	✓	35
G156	056B17D2012	✓	24,167	G345	056T34F5335		47	G569	056T34F5308		53	G905	056T17G5336	✓	36
G161	056T17D5701		169	G347	056T17F5302	✓	47	G570	056C17F5320	✓	33	G908	056T17D5339	✓	36
G162	056T17D2121	✓	169	G348	SEE K424		47	G571	056C17F5321	✓	33	G910	SEE C167		21
G165	SEE K544		169	G350	SEE C264		29	G572	056C17F5322	✓	33	G911	SEE C168		21
G166	SEE K546		169	G352	056C34F5308	✓	29	G573	056C17F5323	✓	33	G912	SEE C169		21,183
G167	SEE K1409		169	G354	SEE C268		29	G574	056B17F5305	✓	33	G913	SEE C1263		21
G168	SEE K279		169	G355	SEE C269		29	G575	056B17F5306	✓	33	G915	056C34D2100	✓	21
G169	SEE K280		169	G356	056C17F5308	✓	29	G576	056C11F5303	✓	33	G917	SEE C175		21
G180	SEE K1411		169	G357	SEE C271		29	G577	056C11F5302	✓	33	G918	SEE C176		21
G181	SEE K518		169	G359	056C34F5310	✓	30	G578	056B11F5303	✓	33	G919	056B17D2010	✓	21
G182	SEE K519		169	G360	SEE K165		47	G579	056B11F5302	✓	33	G921	056T17D5342	✓	36
G183	SEE K1413		169	G363	056T34F5336		48	G580	056T17T5305	✓	53	G923	056T17D5344	✓	37
G184	SEE K520		169	G365	SEE K167		48	G581	056T17F5321	✓	53	G930	SEE C178		21
G185	SEE K549		169	G368	056T34F5337		48	G582	056T17F5322	✓	53	G932	SEE C179		21
G186	SEE K1416		169	G369	SEE K1492		48	G583	056T17F5323	✓	53	G934	SEE C181		21
G201	SEE K248		40	G371	SEE C275		30	G584	056T17F5324	✓	54	G935	SEE C182		21
G203	SEE K249		40	G372	SEE C276		30	G585	056T17F5325	✓	54	G936	SEE C1480		21,183,189
G205	056T34D5327		40	G373	056C17F5311	✓	30,190	G586	056T11F5311	✓	53	G937	056B34D2026	✓	22
G207	SEE K250		40	G374	056B34F5320	✓	30	G587	056T11F5310	✓	53	G939	SEE C185		22
G212	056C17D2084	✓	27	G376	SEE G1376		30	G588	056T11F5309	✓	53	G950	SEE C186		22
G216	056C34D2117	✓	27	G377	SEE G1377		30	G589	056T11F5308	✓	53	G951	056C17D5308	✓	22,183
G221	SEE K251		40	G378	056B17F5302	✓	30,190	G590	056T17F5355	✓	54	G952	SEE C187		22
G225	SEE K521		40	G379	056C34F5309	✓	29,190	G591	056T17F5356		54	G958	056B17D5323	✓	189
G229	SEE K644		40	G380	056C17F5957		190	G639	056C17E5314	✓	34	G961	056T17D2118	✓	169
G230	056C17D2085	✓	27	G381	056C17F5955	✓	190	G646	056T17E5308	✓	76	G962	056T17D2119	✓	169
G232	056C34D2108	✓	27	G382	056C17F5956	✓	190	G647	056T17E5309	✓	76	G963	056T17D2120	✓	169
G234	056C17D2044	✓	27	G383	SEE K166		48	G648	056T34G5303		76	G964	056T17D2117		169
G238	056C34D2101	✓	27	G385	056T34F5338		48	G649	056T17G5312	✓	76	G965	056T17D5357		169
G242	056T17D2115	✓	40	G387	056T17F5327		48	G650	056C11G5306	✓	34	G966	SEE K277		169
G243	056T17D2116	✓	40	G390	056C34F5311	✓	30,190	G651	056C17G5315	✓	34	G967	056T17D5385		169
G244	056T17D2127		40	G391	056B34F5321	✓	30	G652	056C11G5307	✓	34	G976	056B34D5304		189
G245	SEE K247		40	G392	SEE G1392		30	G653	056C34G5308	✓	34	G979	056B17D5319		189
G248	SEE K1299		40	G393	056C34F5307	✓	29	G654	056C17G5316	✓	34	G987	056B34D2021		189
G250	056B17D2011	✓	27	G396	056B17F5310	✓	190	G655	056B11G5301	✓	34	G996	056B34D5334		189
G254	056B34D2031	✓	27	G502	SEE K253		51	G656	056C34G5309		34	G1098	5KCC3JN266	✓	21
G256	056C17D5310	✓	27	G503	SEE K522		51	G657	056C17G5317	✓	34	G1114	5KC35JN7	✓	24,167
G258	056B34D2023	✓	27	G507	SEE K254		51	G658	056C34G5310		34	G1115	5KC35JN7X	✓	24,167
G270	056C17D5311	✓	27	G508	SEE K469		51	G659	056C17G5318	✓	34	G1312	5KC32GN19	✓	29
G272	056B34D5319	✓	27	G511	SEE G1511		31	G660	056T34G5304		76	G1316	5KC49MN6061	✓	29
G274	056B17D5303	✓	27	G513	SEE G1513		31	G661	056T17G5313	✓	76	G1330	5KC35MN43	✓	29
G278	056C11D5304	✓	27,170	G514	056C34F5322		31	G662	056T34G5305	✓	76	G1331	5KC35MN43X	✓	29
G289	056T34D5339		40	G515	SEE G1515		31	G663	056T17G5314	✓	76	G1340	5K36PN251	✓	47
G290	056B17D5328		189	G516	056C34F5323	✓	31	G664	056T17E5314	✓	76	G1376	5KCR48WN0273	✓	30
G294	056B34D5307		189	G517	SEE G1517		31	G665	056T17E5315		76	G1377	5KCR48WN0273X	✓	30
G301	SEE K321		47	G518	056C34F5324	✓	31	G666	056T17G5321	✓	76	G1392	5KCR49TN2139U	✓	30
G303	SEE K154		47	G519	SEE G1519		31	G667	056T17G5322	✓	76	G1511	5KC32GN25	✓	31
G304	056T17F2043	✓	47	G522	SEE K255		51	G668	056T17G5323	✓	76	G1513	5KC35MN73	✓	31
G306	SEE K155		47	G523	SEE K523		51	G827	056T17E5310	✓	77	G1515	5KC42GN0018	✓	31
G308	056T34F5328	✓	47	G527	SEE K256		51	G828	056T17E5311	✓	77	G1517	5KC46PN0032	✓	31

## Catalog Number/Model Number

CAT. NO.	MODEL NO.	STOCK	PAGE NO.	CAT. NO.	MODEL NO.	STOCK	PAGE NO.	CAT. NO.	MODEL NO.	STOCK	PAGE NO.	CAT. NO.	MODEL NO.	STOCK	PAGE NO.
G1519	5KC49TN0035	✓	31	GT0430	284TTDCA6007	✓	130	GT1046	405TFC6036	✓	63	GT1210	182TFFB6028	✓	64
G1531	5KCR48WN0294	✓	31	GT0431	286TTDCA6032	✓	130	GT1047	444TFC6086	✓	63	GT1211	213TFFBA6078	✓	64
GT0005	182TTDB6076	✓	45	GT0433	286TTDCA6007	✓	130	GT1048	444STFC6001	✓	63	GT1212	184TFFB6003	✓	64
GT0008	184TTDB6076	✓	45	GT0434	324TTDCA6032	✓	130	GT1049	444TFC6036	✓	63	GT1213	184TFFB6028	✓	64
GT0010	182TTDB6026	✓	45	GT0436	324TTDCA6007	✓	130	GT1050	445TFC6086	✓	63	GT1214	215TFFBA6078	✓	64
GT0011	213TTDB6076	✓	45	GT0437	326TTDCA6032	✓	130	GT1051	445STFC6001	✓	63	GT1215	213TFFBA6003	✓	64
GT0012	182TTDB6001	✓	45	GT0501	143TTDR6031	✓	129	GT1052	445TFC6036	✓	63	GT1216	213TFFBA6028	✓	64
GT0013	184TTDB6026	✓	45	GT0503	143TTDR6008	✓	129	GT1053	447TFC6087	✓	63	GT1217	254TFFCA6078	✓	64
GT0014	215TTDB6076	✓	45	GT0504	145TTDR6031	✓	129	GT1054	447STFC16004	✓	63	GT1218	215TFFBA6003	✓	65
GT0015	184TTDB6001	✓	45	GT0506	145TTDR6004	✓	129	GT1055	447TFC6038	✓	63	GT1219	215TFFBA6028	✓	65
GT0016	213TTDB6026	✓	45	GT0507	145TTDR6030	✓	129	GT1056	449TFC6088	✓	63	GT1220	256TFFCA6078	✓	65
GT0017	254TTDCA6076	✓	45	GT0509	145TTDR6006	✓	130	GT1105	182TFC6080	✓	61	GT1221	254TFFCA6003	✓	65
GT0018	213TTDB6001	✓	45	GT0510	182TTDB6033	✓	130	GT1108	184TFC6080	✓	61	GT1222	254TFFCA6028	✓	65
GT0019	215TTDB6026	✓	45	GT0512	182TTDB6008	✓	130	GT1109	182TFC6005	✓	61	GT1224	256TFFCA6003	✓	65
GT0020	256TTDCA6076	✓	45	GT0513	184TTDB6033	✓	130	GT1110	182TFC6030	✓	61	GT1225	256TFFCA6028	✓	65
GT0021	215TTDB6001	✓	45	GT0515	184TTDB6008	✓	130	GT1111	213TFC6080	✓	61	GT1227	284STFCA6003	✓	65
GT0022	254TTDCA6026	✓	45	GT0516	213TTDB6033	✓	130	GT1112	184TFC6005	✓	61	GT1228	284TFFCA6028	✓	65
GT0023	284TTDCA6076	✓	45	GT0518	213TTDB6008	✓	130	GT1113	184TFC6030	✓	61	GT1230	286STFCA6003	✓	65
GT0024	254TTDCA6001	✓	45	GT0519	215TTDB6033	✓	130	GT1114	215TFC6080	✓	61	GT1231	286TFFCA6028	✓	65
GT0025	256TTDCA6026	✓	45	GT0521	215TTDB6008	✓	130	GT1115	213TFC6005	✓	61	GT1233	324STFCA6003	✓	65
GT0026	286TTDCA6076	✓	45	GT0522	254TTDCA6033	✓	130	GT1116	213TFC6030	✓	61	GT1234	324TFFCA6028	✓	65
GT0027	256TTDCA6001	✓	45	GT0524	254TTDCA6008	✓	130	GT1117	254TFFCA6080	✓	61	GT1236	326STFCA6003	✓	65
GT0028	284TTDCA6026	✓	45	GT0525	256TTDCA6033	✓	130	GT1118	215TFC6005	✓	61	GT1237	326TFFCA6028	✓	65
GT0029	324TTDCA6076	✓	45	GT0527	256TTDCA6008	✓	130	GT1119	215TFC6030	✓	61	GT1239	364STFCA6003	✓	65
GT0030	284TTDCA6001	✓	45	GT0528	284TTDCA6033	✓	130	GT1120	256TFFCA6080	✓	61	GT1240	364TFFCA6038	✓	65
GT0031	286TTDCA6026	✓	45	GT0530	284TTDCA6008	✓	130	GT1121	254TFFCA6005	✓	61	GT1242	365STFCA6003	✓	65
GT0032	326TTDCA6076	✓	45	GT0531	286TTDCA6033	✓	130	GT1122	254TFFCA6030	✓	61	GT1243	365TFFCA6038	✓	65
GT0033	286TTDCA6001	✓	45	GT0533	286TTDCA6008	✓	130	GT1123	284TFFCA6080	✓	61	GT1245	405STFCA6003	✓	65
GT0034	324TTDCA6026	✓	45	GT0534	324TTDCA6033	✓	130	GT1124	256TFFCA6005	✓	62	GT1246	405TFFCA6038	✓	65
GT0035	364TTDCB6086	✓	45	GT0536	324TTDCA6008	✓	130	GT1125	256TFFCA6030	✓	62	GT1305	182TFFB6079	✓	64
GT0036	324TTDCA6001	✓	45	GT0537	326TTDCA6033	✓	130	GT1126	286TFFCA6080	✓	62	GT1308	184TFFB6079	✓	64
GT0037	326TTDCA6026	✓	45	GT1005	182TFC6076	✓	61	GT1127	284STFCA6005	✓	62	GT1309	182TFFB6004	✓	64
GT0038	365TTDCB6086	✓	45	GT1008	184TFFCA6076	✓	61	GT1128	284TFFCA6030	✓	62	GT1310	182TFFB6029	✓	64
GT0039	326TTDCA6001	✓	45	GT1009	182TFC6001	✓	61	GT1129	324TFFCA6080	✓	62	GT1311	213TFFBA6079	✓	64
GT0040	364TTDCB6060	✓	45	GT1010	182TFC6026	✓	61	GT1130	286STFCA6005	✓	62	GT1312	184TFFB6004	✓	64
GT0041	404TTDC6086	✓	45	GT1011	213TFFCA6076	✓	61	GT1131	286TFFCA6030	✓	62	GT1313	184TFFB6029	✓	64
GT0042	364TTDCB6001	✓	46	GT1012	184TFFCA6001	✓	61	GT1132	326TFFCA6080	✓	62	GT1314	215TFFBA6079	✓	64
GT0043	365TTDCB6060	✓	46	GT1013	184TFFCA6026	✓	61	GT1133	324STFCA6005	✓	62	GT1315	213TFFBA6004	✓	64
GT0044	405TTDC16081	✓	46	GT1014	215TFFCA6076	✓	61	GT1134	324TFFCA6030	✓	62	GT1316	213TFFBA6029	✓	64
GT0045	365TTDCB6001	✓	46	GT1015	213TFFCA6001	✓	61	GT1135	364TFFCA6080	✓	62	GT1318	215TFFBA6004	✓	64
GT0046	404TTDC6060	✓	46	GT1016	213TFFCA6026	✓	61	GT1136	326STFCA6005	✓	62	GT1319	215TFFBA6029	✓	64
GT0047	444TTDC16077	✓	46	GT1017	254TFFCA6076	✓	61	GT1137	326TFFCA6030	✓	62	GT1401	143TFFR16039	✓	64
GT0048	404TTDC6001	✓	46	GT1018	215TFFCA6001	✓	61	GT1138	365TFFCA6080	✓	62	GT1403	143TFFR16003	✓	64
GT0049	405TTDC6060	✓	46	GT1019	215TFFCA6026	✓	61	GT1139	364STFCA6005	✓	62	GT1404	145TFFR16046	✓	64
GT0050	445TTDC16076	✓	46	GT1020	256TFFCA6076	✓	61	GT1140	364TFFCA6040	✓	62	GT1406	145TFFR16005	✓	64
GT0051	405TTDC6007	✓	46	GT1021	254TFFCA6001	✓	61	GT1141	404TFFCA6080	✓	62	GT1407	145TFFR16047	✓	64
GT0052	444TTDC6060	✓	46	GT1022	254TFFCA6026	✓	61	GT1142	365STFCA6002	✓	62	GT1409	182TFFB6007	✓	64
GT0053	447TTDC16077	✓	46	GT1023	284TFFCA6076	✓	61	GT1143	365TFFCA6040	✓	62	GT1410	182TFFB6032	✓	64
GT0054	444TTDC16003	✓	46	GT1024	256TFFCA6001	✓	62	GT1144	405TFFCA6080	✓	62	GT1412	184TFFB6007	✓	64
GT0055	445TTDC6060	✓	46	GT1025	256TFFCA6026	✓	62	GT1145	405STFCA6005	✓	63	GT1413	184TFFB6032	✓	64
GT0056	449TTDC16076	✓	46	GT1026	286TFFCA6076	✓	62	GT1146	405TFFCA6040	✓	63	GT1415	213TFFBA6007	✓	64
GT0401	143TTDR6030	✓	129	GT1027	284STFCA6001	✓	62	GT1147	444TFC6080	✓	63	GT1416	213TFFBA6032	✓	64
GT0403	143TTDR6007	✓	129	GT1028	284TFFCA6026	✓	62	GT1148	444STFC16002	✓	63	GT1418	215TFFBA6007	✓	65
GT0404	145TTDR6034	✓	129	GT1029	324TFFCA6076	✓	62	GT1149	444TFC6044	✓	63	GT1419	215TFFBA6032	✓	65
GT0406	145TTDR6007	✓	129	GT1030	286STFCA6001	✓	62	GT1150	445TFC6080	✓	63	GT1421	254TFFCA6007	✓	65
GT0407	145TTDR6036	✓	129	GT1031	286TFFCA6026	✓	62	GT1151	445STFCA6005	✓	63	GT1422	254TFFCA6032	✓	65
GT0409	145TTDR6013	✓	130	GT1032	326TFFCA6076	✓	62	GT1152	445TFC6037	✓	63	GT2001	143TTDR16043	✓	129
GT0410	182TTDB6032	✓	130	GT1033	324STFCA6001	✓	62	GT1153	447TFC6080	✓	63	GT2003	143TTDR16009	✓	129
GT0412	182TTDB6007	✓	130	GT1034	324TFFCA6026	✓	62	GT1154	447STFCA6005	✓	63	GT2004	145TTDR16074	✓	129
GT0413	184TTDB6032	✓	130	GT1035	364TFFCA6086	✓	62	GT1155	447TFC6039	✓	63	GT2006	145TTDR16015	✓	129
GT0415	184TTDB6007	✓	130	GT1036	326STFCA6001	✓	62	GT1156	449TFC6080	✓	63	GT2007	145TTDR16335	✓	129
GT0416	213TTDB6032	✓	130	GT1037	326TFFCA6026	✓	62	GT1201	143TFFR6032	✓	64	GT2009	145TTDR16023	✓	130
GT0418	213TTDB6007	✓	130	GT1038	365STFCA6086	✓	62	GT1202	145TFFR16079	✓	64	GT2301	143TTDR16044	✓	139
GT0419	215TTDB6032	✓	130	GT1039	364STFCA6001	✓	62	GT1203	143TFFR6010	✓	64	GT2303	143TTDR16010	✓	139
GT0421	215TTDB6007	✓	130	GT1040	364TFFCA6036	✓	62	GT1204	145TFFR6058	✓	64	GT2304	145TTDR16075	✓	139
GT0422	254TTDCA6032	✓	130	GT1041	404TFFCA6086	✓	62	GT1205	182TFFB6078	✓	64	GT2306	145TTDR16014	✓	139
GT0424	254TTDCA6007	✓	130	GT1042	365STFCA6001	✓	62	GT1206	145TFFR6009	✓	64	GT2307	145TTDR16337	✓	139
GT0425	256TTDCA6032	✓	130	GT1043	365TFFCA6036	✓	62	GT1207	145TFFR6040	✓	64	GT2309	145TTDR16024	✓	139
GT0427	256TTDCA6007	✓	130	GT1044	405TFFCA6086	✓	62	GT1208	184TFFB6078	✓	64	GT2401	143TTDR16048	✓	139
GT0428	284TTDCA6032	✓	130	GT1045	405STFCA6001	✓	63	GT1209	182TFFB6003	✓	64	GT2403	143TTDR16015	✓	139

# Index

## Catalog Number/Model Number

CAT. NO.	MODEL NO.	STOCK	PAGE NO.	CAT. NO.	MODEL NO.	STOCK	PAGE NO.	CAT. NO.	MODEL NO.	STOCK	PAGE NO.	MODEL NO.	CAT. NO.	STOCK	PAGE NO.
GT2404	145TTDR16330	✓	139	GT3127	284TTFCA6006	✓	134	GT3512	184TTFB6013	✓	142	GT5303	143TTFR16008	✓	141
GT2406	145TTDR16020	✓	139	GT3128	284TTFCA6032	✓	134	GT3513	184TTFB6038	✓	142	GT5304	145TTFR16061	✓	141
GT2407	145TTDR16333	✓	139	GT3130	286TTFCA6006	✓	134	GT3515	213TTFB6013	✓	142	GT5306	145TTFR16011	✓	141
GT2409	145TTDR16301	✓	140	GT3131	286TTFCA6032	✓	134	GT3516	213TTFB6038	✓	142	GT5307	145TTFR16069	✓	141
GT2410	182TTDB6037	✓	140	GT3133	324TTFCA6007	✓	134	GT3518	215TTFB6013	✓	142	GT5401	143TTFR16043	✓	141
GT2412	182TTDB6012	✓	140	GT3134	324TTFCA6032	✓	134	GT3519	215TTFB6038	✓	142	GT5403	143TTFR16012	✓	141
GT2413	184TTDB6037	✓	140	GT3136	326TTFCA6007	✓	134	GT3521	254TTFCA6013	✓	142	GT5404	145TTFR16075	✓	141
GT2415	184TTDB6012	✓	140	GT3137	326TTFCA6032	✓	134	GT3522	254TTFCA6038	✓	142	GT5406	145TTFR16015	✓	141
GT2416	213TTDB6037	✓	140	GT3201	143TTFR16046	✓	133	GT3524	256TTFCA6013	✓	142	GT5407	145TTFR16055	✓	141
GT2418	213TTDB6012	✓	140	GT3203	143TTFR16013	✓	133	GT3525	256TTFCA6038	✓	142	GT5501	143TTFR16045	✓	141
GT2419	215TTDB6037	✓	140	GT3204	145TTFR16063	✓	133	GT3527	284TTFCA6013	✓	142	GT5503	143TTFR16014	✓	141
GT2421	215TTDB6012	✓	140	GT3206	145TTFR16018	✓	133	GT3528	284TTFCA6038	✓	142	GT5504	145TTFR16065	✓	141
GT2422	254TTDCA6037	✓	140	GT3207	145TTFR16071	✓	133	GT3530	286TTFCA6013	✓	142	GT5506	145TTFR16019	✓	141
GT2424	254TTDCA6012	✓	140	GT3209	182TTFB6008	✓	134	GT3531	286TTFCA6038	✓	142	GT5507	145TTFR16073	✓	141
GT2425	256TTDCA6037	✓	140	GT3210	182TTFB6033	✓	134	GT3533	324TTFCA6013	✓	142	H112	5KH37PN39	✓	165
GT2427	256TTDCA6012	✓	140	GT3212	184TTFB6008	✓	134	GT3534	324TTFCA6038	✓	142	H113-(GE)	SEE HG113	165	
GT2428	284TTDCA6037	✓	140	GT3213	184TTFB6033	✓	134	GT3536	326TTFCA6013	✓	142	H114	5KH35FN124	✓	165
GT2431	286TTDCA6037	✓	140	GT3215	213TTFB6008	✓	134	GT3537	326TTFCA6038	✓	142	H115-(GE)	SEE HG115	165	
GT2432	284TTDCA6012	✓	140	GT3216	213TTFB6033	✓	134	GT4001	143TTDR16042	✓	129	H116	5KH32EN66	✓	29
GT2433	286TTDCA6012	✓	140	GT3218	215TTFB6008	✓	134	GT4003	143TTDR16012	✓	129	H120-(GE)	SEE HG120	29	
GT2434	324TTDCA6037	✓	140	GT3219	215TTFB6033	✓	134	GT4004	145TTDR16073	✓	129	H121-(GE)	SEE HG121	29	
GT2436	324TTDCA6012	✓	140	GT3221	254TTFCA6008	✓	134	GT4006	145TTDR16013	✓	129	H123-(GE)	SEE HG123	29	
GT2437	326TTDCA6037	✓	140	GT3222	254TTFCA6033	✓	134	GT4007	145TTDR16336	✓	129	H124-(GE)	SEE HG124	29	
GT2501	143TTDR16040	✓	139	GT3224	256TTFCA6008	✓	134	GT4009	145TTDR16022	✓	130	H130	5KH39QN9632	✓	166
GT2503	143TTDR16006	✓	139	GT3225	256TTFCA6033	✓	134	GT4101	143TTDR16047	✓	129	H131	5KH39QN9631T	✓	166
GT2504	145TTDR16327	✓	139	GT3227	284TTFCA6008	✓	134	GT4103	143TTDR16013	✓	129	H133	5KH39QN9642T	✓	166
GT2506	145TTDR16017	✓	139	GT3228	284TTFCA6033	✓	134	GT4104	145TTDR16329	✓	129	H134	5KH32FN3122	✓	102
GT2507	145TTDR16339	✓	139	GT3230	286TTFCA6008	✓	134	GT4106	145TTDR16019	✓	129	H135	5KH32FN3122S	✓	102
GT2509	145TTDR16303	✓	140	GT3231	286TTFCA6033	✓	134	GT4107	145TTDR16332	✓	129	H136	5KH49MN6057	✓	102
GT2510	182TTDB6038	✓	140	GT3233	324TTFCA6008	✓	134	GT4109	145TTDR16305	✓	130	H137	5KH49MN6057S	✓	102
GT2512	182TTDB6013	✓	140	GT3234	324TTFCA6033	✓	134	GT4201	143TTDR16039	✓	129	H138-(GE)	SEE HG138	102	
GT2513	184TTDB6038	✓	140	GT3236	326TTFCA6008	✓	134	GT4203	143TTDR16007	✓	129	H139	5KH33JN3121S	✓	102
GT2515	184TTDB6013	✓	140	GT3237	326TTFCA6033	✓	134	GT4204	143TTDR16046	✓	129	H140-(GE)	SEE HG140	102	
GT2516	213TTDB6038	✓	140	GT3301	143TTFR16049	✓	141	GT4206	145TTDR16018	✓	129	H141-(GE)	SEE HG141	102	
GT2518	213TTDB6013	✓	140	GT3303	143TTFR16009	✓	141	GT4207	145TTDR16338	✓	129	H142-(GE)	SEE HG142	102	
GT2519	215TTDB6038	✓	140	GT3304	145TTFR16060	✓	141	GT4209	145TTDR16302	✓	130	H143-(GE)	SEE HG143	102	
GT2521	215TTDB6013	✓	140	GT3306	145TTFR16016	✓	141	GT4301	143TTDR16045	✓	139	H150	143TTDR5376	✓	36
GT2522	254TTDCA6038	✓	140	GT3307	145TTFR16068	✓	141	GT4303	143TTDR16011	✓	139	H152-(GE)	SEE HG152	165	
GT2524	254TTDCA6013	✓	140	GT3401	143TTFR16051	✓	141	GT4304	145TTDR16326	✓	139	H154-(GE)	SEE HG154	165	
GT2525	256TTDCA6038	✓	140	GT3403	143TTFR16011	✓	141	GT4306	145TTDR16307	✓	139	H155-(GE)	SEE HG155	165	
GT2527	256TTDCA6013	✓	140	GT3404	145TTFR16326	✓	141	GT4307	145TTDR16342	✓	139	H156-(GE)	SEE HG156	165	
GT2528	284TTDCA6038	✓	140	GT3406	145TTFR16014	✓	141	GT4309	145TTDR16025	✓	140	H157	5KH32DN3085X	✓	165
GT2531	286TTDCA6038	✓	140	GT3407	145TTFR16056	✓	141	GT4401	143TTDR16049	✓	139	H158	5KH37PN41	✓	165
GT2532	284TTDCA6013	✓	140	GT3409	182TTFB6012	✓	142	GT4403	143TTDR16014	✓	139	H159	5KH37PN41X	✓	165
GT2533	286TTDCA6013	✓	140	GT3410	182TTFB6037	✓	142	GT4404	145TTDR16331	✓	139	H160	5KH32FN3083	✓	165
GT2534	324TTDCA6038	✓	140	GT3412	184TTFB6012	✓	142	GT4406	145TTDR16021	✓	139	H161-(GE)	SEE HG161	165	
GT2536	324TTDCA6013	✓	140	GT3413	184TTFB6037	✓	142	GT4407	145TTDR16334	✓	139	H162	5KH46MN6053	✓	165
GT2537	326TTDCA6038	✓	140	GT3415	213TTFB6012	✓	142	GT4409	145TTDR16306	✓	140	H163	5KH46MN6053X	✓	165
GT3001	143TTFR16047	✓	133	GT3416	213TTFB6037	✓	142	GT4501	143TTDR16041	✓	139	H164	5KH32JN3128	✓	166
GT3003	143TTFR16007	✓	133	GT3418	215TTFB6012	✓	142	GT4503	143TTDR16008	✓	139	H165	5KH32JN3128X	✓	166
GT3004	145TTFR16059	✓	133	GT3419	215TTFB6037	✓	142	GT4504	145TTDR16328	✓	139	H166	5KH35JN26	✓	166
GT3006	145TTFR16010	✓	133	GT3421	254TTFCA6012	✓	142	GT4506	145TTDR16016	✓	139	H167	5KH35JN26X	✓	166
GT3007	145TTFR16067	✓	133	GT3422	254TTFCA6037	✓	142	GT4507	145TTDR16340	✓	139	H168	5KH49PN6055	✓	166
GT3101	143TTFR16032	✓	133	GT3424	256TTFCA6012	✓	142	GT4509	145TTDR16304	✓	140	H169	5KH36KN114	✓	165
GT3103	143TTFR16010	✓	133	GT3425	256TTFCA6037	✓	142	GT5001	143TTFR16048	✓	133	H170	5KH36KN114X	✓	165
GT3104	145TTFR16036	✓	133	GT3427	284TTFCA6012	✓	142	GT5003	143TTFR16005	✓	133	H171	5KH37PN33	✓	165
GT3106	145TTFR16013	✓	133	GT3428	284TTFCA6037	✓	142	GT5004	145TTFR16058	✓	133	H172	5KH37PN33X	✓	165
GT3107	145TTFR16037	✓	133	GT3430	286TTFCA6012	✓	142	GT5006	145TTFR16009	✓	133	H173	5KH46MN3025	✓	166
GT3109	182TTFB6006	✓	134	GT3431	286TTFCA6037	✓	142	GT5007	145TTFR16066	✓	133	H174	5KH46MN3025X	✓	166
GT3110	182TTFB6031	✓	134	GT3433	324TTFCA6012	✓	142	GT5101	143TTFR16052	✓	133	H175	5KH49PN3026	✓	166
GT3112	184TTFB6006	✓	134	GT3434	324TTFCA6037	✓	142	GT5103	143TTFR16006	✓	133	H176	5KH49PN3026X	✓	166
GT3113	184TTFB6031	✓	134	GT3436	326TTFCA6012	✓	142	GT5104	145TTFR16074	✓	133	H178	447TSTDN7001	✓	39, 145
GT3115	213TTFB6006	✓	134	GT3437	326TTFCA6037	✓	142	GT5106	145TTFR16012	✓	133	H178-(GE)	SEE HG178	168	
GT3116	213TTFB6031	✓	134	GT3501	143TTFR16044	✓	141	GT5107	145TTFR16057	✓	133	H180	143TTDR5401	✓	36
GT3118	215TTFB6006	✓	134	GT3503	143TTFR16015	✓	141	GT5201	143TTFR16042	✓	133	H181	145TTDR5401	✓	36
GT3119	215TTFB6031	✓	134	GT3504	145TTFR16064	✓	141	GT5203	143TTFR16004	✓	133	H181-(GE)	SEE B1502	168	
GT3121	254TTFCA6006	✓	134	GT3506	145TTFR16021	✓	141	GT5204	145TTFR16062	✓	133	H182A	182TTDW7101	✓	37
GT3122	254TTFCA6031	✓	134	GT3507	145TTFR16072	✓	141	GT5206	145TTFR16017	✓	133	H182-(GE)	SEE HG182	168	
GT3124	256TTFCA6006	✓	134	GT3509	182TTFB6013	✓	142	GT5207	145TTFR16070	✓	133	H183A	184TTDW7101	✓	37
GT3125	256TTFCA6031	✓	134	GT3510	182TTFB6038	✓	142	GT5301	143TTFR16050	✓	141	H184	SEE H184A	37	

CAT. NO.	MODEL NO.	STOCK	PAGE NO.	CAT. NO.	MODEL NO.	STOCK	PAGE NO.	CAT. NO.	MODEL NO.	STOCK	PAGE NO.	CAT. NO.	MODEL NO.	STOCK	PAGE NO.
H184A	213TTDWD14102		37	H298	5KH48UN6054X	✓	166	H697-(GE)	SEE X1903		102	HG141	5KH36NN37S	✓	102
H185	SEE H185A		38	H300	5KH49SN3048	✓	165	H698-(GE)	SEE X1904		102	HG142	5KH49PN6056	✓	102
H185A	215TTDWD14110		38	H344	5KH36KNB633X	✓	119	H699-(GE)	SEE HG699		102	HG143	5KH42GN0337	✓	102
H185-(GE)	SEE B1504		168	H350	143TTGN7076	✓	79	H700	143TTFR5376	✓	47	HG152	5KH32GN140X	✓	165
H186	SEE H186A		38	H439	5KH39EN2552X	✓	120	H700-(GE)	SEE HG700		166	HG154	5KH36KN113X	✓	165
H186A	254TTDX14104	✓	38	H440	5KH39EN2506X	✓	120	H701-(GE)	SEE HG701		165	HG155	5KH46MN3021X	✓	165
H186-(GE)	SEE HG186		168	H450-(GE)	SEE HG450		119	H703-(GE)	SEE HG703		166	HG156	5KH32DN3085	✓	165
H187	256TTDX7101	✓	38	H451	5KH32GNB813X	✓	119	H704-(GE)	SEE HG704		165	HG161	5KH32FN3083X	✓	165
H187A	256TTDN14102	✓	38	H454	5KH32ENB168X	✓	34	H705-(GE)	SEE HG705		166	HG178	5KH32EN79	✓	168
H187-(GE)	SEE B1507		168	H455-(GE)	SEE HG455		34	H706-(GE)	SEE HG706		166	HG182	5KH49MN6060	✓	168
H188	SEE H188A		38	H456-(GE)	SEE HG456		34	H710-(GE)	SEE HG710		26	HG186	5KH46PN6059	✓	168
H188A	284TTDN14102		38	H457	143TTFN8076	✓	49	H711-(GE)	SEE HG711		166	HG188	5KH49UN6064	✓	168
H188-(GE)	SEE HG188		168	H458-(GE)	SEE HG458		34	H712	5KH32GNB815X	✓	119	HG189	5KH36PN108	✓	168
H189	SEE H189A		38	H502	449TTGS7068		81	H714-(GE)	SEE HG714		119	HG191	5KH46PN3033	✓	168
H189A	286TTDN14101		38	H503	449TTGS7037		81	H715-(GE)	SEE HG715		166	HG196	5KH32GN42S	✓	102
H189-(GE)	SEE HG189		168	H504	449TTGS7036	✓	81	H716-(GE)	SEE HG716		174	HG450	5KH32GNB812X	✓	119
H190	5KH49MN3035	✓	168	H513	SEE E595		81	H717-(GE)	SEE HG717		174	HG455	5KH36NNB166X	✓	34
H191	SEE H191A		38	H580	SEE E595		81	H803	056T17D5398	✓	38	HG456	5KH35LN164X	✓	34
H191A	326TTDR14105		38	H581	SEE H502		81	H804	SEE X920		182	HG458	5KH36PNB171X	✓	34
H191-(GE)	SEE HG191		168	H601	SEE E901		36	H805	SEE X921		182	HG621	5KH49PN6055X	✓	166
H193	447TSTDN7003	✓	39,145	H604	SEE E902		37	H806	SEE X922		182	HG646	5KH39QN9508Y	✓	100
H195	5KH32GN42	✓	102	H607	SEE E903		37	H812	447TSTDN7026	✓	39,145	HG648	5KH32QN9581T	✓	102
H196-(GE)	SEE HG196		102	H613	SEE E1905		38	H813	447TSTDN7027	✓	39,145	HG679	5KH32DN5597X	✓	119
H197	5KH35MN132	✓	102	H615	SEE E937A		38	H814	447TSTDN7028	✓	39,145	HG680	5KH32FN5598X	✓	119
H198	5KH35MN132S	✓	102	H616	SEE E906		38	H815	SEE H815A		39,145	HG681	5KH32GNB814X	✓	119
H203	5KH36PN106	✓	102	H619	SEE E907		38	H815A	449TSTDN14033		39,145	HG690	5KH35JN602X	✓	25
H204	5KH32GN142	✓	170	H620	5KH49PN3043	✓	165	H816	449TSTDN7027		39,145	HG692	5KH36LN489X	✓	26
H205	5KH37PN37	✓	170	H621	SEE E788		38	H817	447TSTDN7005	✓	39,145	HG694	5KH39QN9767X	✓	166
H206	5KH36KN112	✓	170	H621-(GE)	SEE HG621		166	H818	449TSTDN7001	✓	39,145	HG695	5KH37PNA233	✓	165
H207	5KH46MN3041	✓	170	H622	SEE E908		38	H819	SEE H819A		39,145	HG699	5KH49PN6056S	✓	102
H208	5KH32DN111	✓	170	H623	SEE U646A		48	H819A	449TSTDN14005	✓	39,145	HG700	5KH32NNA167T	✓	166
H209	5KH37PN36	✓	170	H625	SEE E909		39	H820	449TTDN7086		39	HG701	5KH32DN5618X	✓	165
H210	5KH37PN36X	✓	170	H627	SEE E786		38	H821	SEE H821A		39	HG703	5KH35MNA519T	✓	166
H212	5KH33FN77	✓	170	H628	SEE E910		38	H821A	449TTDN14078		39	HG704	5KH35MNA568T	✓	165
H213	5KH33FN77X	✓	170	H631	SEE U901		39	H822	SEE H822A		39	HG705	5KH46NN3039T	✓	166
H214	5KH46MN6071	✓	170	H632	SEE E911		39	H822A	447TTDN14087		39	HG706	5KH37PNA569T	✓	166
H215	5KH46MN6071X	✓	170	H636	SEE E787		39	H891	5KC49LN6386X	✓	34	HG710	5KH33JNA511T		26
H217	5KH35JN121	✓	170	H641	5KH39CN5501X	✓	119	H901	5KH32DNA612	✓	22	HG711	5KH32HN5620T	✓	166
H218	5KH35JN121X	✓	170	H642	5KH39CN5504X	✓	119	H902	5KH32DNA612X	✓	22	HG714	5KH37PNA479X	✓	119
H219	5KH49PN6069	✓	170	H645	5KH39QNB810	✓	25	H903	5KH32FNA611	✓	22	HG715	5KH38SNA731T	✓	166
H221	5KH48UN6074	✓	170	H646-(GE)	SEE HG646		100	H904	5KH32FNA611X	✓	22	HG716	5KH36DNA780X		174
H222	5KH49PN3047	✓	170	H647	5KHC39QN9584X	✓	102	H905	5KH36JNA769	✓	22	HG717	5KH37GNA782X		174
H223	5KH37PN40	✓	170	H648-(GE)	SEE HG648		102	H906	5KH36JNA769X	✓	22	I101	143TCDR5303		22
H224	5KH49SN3049	✓	170	H649	5KHC39QN9575T	✓	102	H907	5KH37NNA768	✓	22	I102	145TBDR5302	✓	22
H225	5KH46MN3040	✓	170	H664	SEE E824		47	H908	5KH37NNA768X	✓	22	I103	SEE I103A		22
H226	5KH49PN3042	✓	170	H665	SEE E836		48	H912	5KH32DNA700		165	I103A	182TCDW7001	✓	22
H229	5KH35HN9	✓	23	H666	SEE E845		48	H913	5KH32DNA700X		165	I104	SEE I104A		22
H230	5KH39QN9091		23	H668	SEE H1668		48	H914	SEE H160		165	I104A	184TBDW17008	✓	22
H233	5KH36PN109	✓	168	H669	SEE U627		48	H915	5KH33FNA722X	✓	165	I105	213TCDW7001	✓	22,183
H234	5KH39QN9105X	✓	168	H670	SEE E822		48	H917	5KH35JNA723X		166	I106	215TCDW17002	✓	22
H236	5KH35MN56X	✓	168	H673	5KH33KN5594	✓	26	H919	5KH36MNA735X		166	I108A	184TBDW7001	✓	22,183
H239	5KH33FN6	✓	21	H674	5KH35JNA231	✓	26	H926	5KH36MNB637X	✓	119	I110	SEE C188		21
H243	5KH32GN68X	✓	29	H675	5KH33FNA230	✓	25	H950	5KH140DFK1X	✓	119	I111	SEE C191		22
H244	5KH32EN124	✓	31	H676	5KH35GNA229	✓	23	H951	5KH140DFK17X	✓	119	I112A	182TCDW7026	✓	22
H247	5KH42JN0328S	✓	102	H679	SEE E1799		37	H952	145TTDR5647		191	I113	SEE I113A		22
H248	5KH36MN3106X	✓	166	H679-(GE)	SEE HG679		119	H953	182TTDR8353		191	I113A	184TCDW7026	✓	22
H274	SEE U651		48	H680-(GE)	SEE HG680		119	H954	184TTDR9040	✓	191	I114	SEE I114A		22,183
H275	5KH49PN3045	✓	166	H681-(GE)	SEE HG681		119	H955	213TTDWD7053		191	I114A	184TBDW7026	✓	22,183
H276	5KH42JN0328	✓	102	H682	5KH32ENA443X	✓	119	H956	215TTDWD7053	✓	191	I115	215TBDW7026	✓	22,183
H277	5KH33KN20S	✓	102	H683	5KH33GNA444X	✓	119	H957	254TTDX8338		191	I116	215TBDW7028	✓	22,183
H278	5KH37PN37X	✓	170	H684	5KH36MNA445X	✓	119	H1613	SEE E1905		38	I117	213TCDW7026		22
H280	5KH49UN3024X	✓	170	H685	5KH39EN2887X	✓	120	H1668	184TTFW7727	✓	48	I118	SEE C193		22
H282	5KH49PN3042X	✓	170	H689	5KH35JN603X	✓	23	HG113	5KH37PN39X	✓	165	I119	184TBDR3735	✓	183,189
H286	5KH36MN3106	✓	166	H690-(GE)	SEE HG690		25	HG115	5KH35FN124X	✓	165	I127	145TBDR5337	✓	22,183,189
H287	5KH36KN112X	✓	170	H691	5KH36LN488X	✓	23	HG120	5KH32FN3123	✓	29	I128	184TBDR7631	✓	189
H288	5KH49SN3023X	✓	170	H692-(GE)	SEE HG692		26	HG121	5KH32FN3123X	✓	29	I128A	184TBDW7631	✓	189
H290	5KH36MN137	✓	170	H693	5KH46JN0329X	✓	26	HG123	5KH33FN85	✓	29	I130	SEE I130A		189
H291	5KH32EN72X	✓	168	H694-(GE)	SEE HG694		166	HG124	5KH33FN85X	✓	29	I130A	184TBDW7630	✓	189
H293	5KH46PN3034	✓	168	H695-(GE)	SEE HG695		165	HG138	5KH33JN3121	✓	102	I131	184TBDR7632	✓	189
H296	5KH49SN3046	✓	165	H696	5KH36LNA504	✓	23	HG140	5KH36NN37	✓	102	I131A	184TBDW7632	✓	189

# Index

## Catalog Number/Model Number

CAT. NO.	MODEL NO.	STOCK	PAGE NO.	CAT. NO.	MODEL NO.	STOCK	PAGE NO.	CAT. NO.	MODEL NO.	STOCK	PAGE NO.	MODEL NO.	CAT. NO.	STOCK	PAGE NO.
I141	182TCDR17079		21	J047	056T34D5368		122	K162	5K46PN6082	✓	47	K319-(GE)	SEE KG319		191
I142	184TCDR7076		22	J048	056T34D5367	✓	122	K163	5K38RN30	✓	47	K321	5K35MN75	✓	47
I143	213TCDW7076		22	J049	056T34D5365	✓	122	K164	5K49MN4105	✓	47	K330	SEE K2033		51
I144	215TBDW7079		22	J050	056T34D5366	✓	122	K165	5K49UN6085	✓	47	K332	056B34F5303		190
I145	145TBDR5303		23	J051	056T34D5369	✓	122	K166	5K46KN2175		48	K339	056C34F5327		29
I146	145TCDR5331	✓	25,167	J052	056T34D5370	✓	122	K167	5K49SN4118	✓	48	K350	056B34F5322		30
I147	145TBDR5345	✓	25,167	J053	056T34D5371	✓	122	K194	5K33KN92	✓	47	K378	5K46LN60335		161
I201	145TBFR5327	✓	30	J054	056C34D2118	✓	121	K196	5K49FN4129	✓	47	K379	5K49RN60345		161
I204	145TBFR5301		30	J055	056C34D2119	✓	121	K197	5K42HN4109	✓	47	K381	5K42HN4089	✓	169
I205	145TBFR5302		30	J056	056C34D2120	✓	121	K198	5K49PN4113	✓	47	K392	SEE G086		36
I206	182TBFR5301	✓	30	J057	056C34D2121	✓	121	K212	056B34D2018		189	K393	SEE K007		37
I210	SEE C295		30	J058	056B34D2033	✓	121	K215-(GE)	SEE KG215		40,123,172	K402	SEE H181		36
I211	SEE C297		30	J059	056B34D5341	✓	121	K216	5K36JN57	✓	40,123,172	K404	056T11F5320		51
I212	182TBFR5326	✓	30	J060	056T34T5308		123	K217	5K36JN56	✓	122	K405	056T117F2047		51
I213	SEE I213A		30	J061	056T34F5342	✓	123	K218	5K37MN37	✓	40,123,172	K406	SEE K640		52
I213A	184TBFW17044	✓	30	J062	056T34F5343	✓	123	K219	056B34D5336		189	K407	056T11F5321		51
I214	184TBFR7726	✓	30	J063	056T34F5344	✓	123	K219-(GE)	SEE KG219		122	K408	5K49SN8050	✓	37
I214A	184TBFW7726	✓	30	J064	056T34F5345	✓	123	K220	5K38PN47	✓	40,123,172	K418	5K32GN53	✓	47
I215	215TBFW7026	✓	30	J065	056T34F5346	✓	123	K221	5K38PN48	✓	122	K420	SEE K151		47
I216	213TBFW7026	✓	30	J066	056T34F5347	✓	123	K222	5K46KN2173	✓	40,123,172	K421-(GE)	SEE G1340		47
I217	215TBFW7027	✓	30	J1025	5KC37FN71X	✓	121,172	K223	5K46KN2172	✓	122	K424	5K49MN4111	✓	47
I220	143TBFR5301	✓	30	K000	056T34D5302	✓	36	K224	5K49NN2180	✓	40,123,172	K426	5K42HN4134	✓	47
I221	145TBFR5303	✓	30	K003	056T17D2113	✓	36	K225	5K49NN2178	✓	122	K439	5K49DN4131	✓	47
I223	SEE I223A		30	K004	056T17D2092	✓	36	K226	5K48TN2182	✓	40,123,172	K456	5K49KN4573	✓	97
I223A	184TBFW7701	✓	30	K007	056T11D5304		37	K227	5K48TN2181	✓	122	K457	5K49KN4563	✓	97
I224	213TBFW7001	✓	30	K009	056T34D5303	✓	37	K228	SEE P101		51,123	K458	5K49PN4564	✓	97
I225	215TBFW7001	✓	30	K016	056B17D56	✓	183,189	K229	SEE P102		51,123	K459	5K49UN4569	✓	97
I305	184TBDR7628		189	K022	056T17D5309	✓	37	K230	5K35JN47	✓	123	K460	5K49PN4565	✓	97
I308	184TBDR7634		189	K025	056T34D5304	✓	37	K231	SEE P103		51,123	K461	5K49UN4566	✓	97
I311	145TBFR5333		190	K027	056T34D5300		36	K232	056B17D5322	✓	189	K462	5K49UN4567	✓	97
I314	SEE I314A		32,101,190	K032	056C17E5302		34	K232-(GE)	SEE KG232		123	K469	5K42HN4137	✓	51
I314A	184TBFW7041	✓	32,101,190	K033	056C11G5303	✓	34	K233	SEE P104		51,123	K499	SEE D392		53
I315	SEE I315A		32,101,190	K037	056C17G5308		34	K234	056C17D2114		28	K500	5K38RN106	✓	53
I315A	184TBFW7034	✓	32,101,190	K041	056T17D5310	✓	37	K234-(GE)	SEE KG234		123	K501	SEE D395		54
I502	143TTGR16026	✓	76	K048	056T34D5340		37	K235	056C17D2115	✓	28	K518	5K49SN3054	✓	169
I503	143TTGR16030		76	K049	056T17D2130	✓	37	K235-(GE)	SEE KG235		51	K519	5K49SN3055	✓	169
I504	145TTGR16076	✓	76	K061	056T17D5369	✓	37	K236	SEE E261		28	K520	5K48UN3056	✓	169
I505	145TTGR16080		76	K062	056T17D5370	✓	37	K236-(GE)	SEE KG236		123	K521	5K49PN4120	✓	40
I506	143TTGR16001	✓	76	K063	056T17D3301	✓	36	K237	SEE E270		28	K522	5K33KN67	✓	51
I507	143TTGR16005	✓	76	K064	056T17D3302	✓	37	K237-(GE)	SEE KG237		51	K523	5K36PN254	✓	51
I508	145TTGR16038	✓	76	K065	056T17D3303	✓	37	K238	5K49SN2184	✓	123	K524	5K49MN4112	✓	51
I509	145TTGR16030	✓	76	K066	056T17D3304	✓	38	K239	SEE P107		52,123	K525	5K49MN4114	✓	168
I512	145TTGR16002	✓	76	K067	056T17D3305		36	K240	5K49ZN2190	✓	123	K526	5K49MN6369	✓	97
I513	145TTGR16004	✓	76	K068	056T17D3306	✓	37	K247	5K49DN4132	✓	40	K527	5K35JN198	✓	36
I514	145TTGR16040	✓	76	K069	056T17D3307	✓	37	K248	5K49FN4138	✓	40	K541	5K49MN6081	✓	168
I515	145TTGR16039	✓	76	K080	056T17D3308	✓	38	K249	5K42HN4127	✓	40	K544	5K42JN3051	✓	169
I700	145TBFR5334	✓	30	K081	056T17D15528		37	K250	5K46KN4125	✓	40	K546	5K42JN3050	✓	169
I702	145TBFR5336		190	K111	SEE G044		36	K251	5K46MN4126	✓	40	K549	5K48UN3057	✓	169
I707	143TBFR5376		29	K113	5K35FN2	✓	36	K252	5K49DN4130	✓	51	K550	5K42HN4133	✓	123
J009	SEE C330		121,172	K114	SEE G047		36	K253	5K33JNA943	✓	51	K553	5K42HN4139	✓	122
J013	SEE C332		121,172	K115	5K36JN2	✓	36	K254	5K35MNB114	✓	51	K555	5K46KN4141	✓	122
J017	SEE C334		121,172	K116	5K42HN4106	✓	36	K255	5K36PNB116	✓	51	K606	5K42GN4619X	✓	66
J019	SEE C336		121,172	K117	SEE G067		36	K256	5K49MN4104	✓	51	K607	5K49MN4620X	✓	66
J021	SEE C338		121,172	K118	SEE G080		36	K257	5K49SN4117	✓	51	K608	5K49MN4618X	✓	66
J023	SEE C340		121,172	K119	5K46KN4071	✓	36	K258	5K49KN4124	✓	53	K609	5K49TN4622X	✓	66
J025	SEE J1025		121,172	K120	SEE G088		36	K259	5K49MN4110	✓	53	K610	5K49RN4621X	✓	66
J033	SEE C329		121	K121	SEE K000		36	K260	5K49SN4119	✓	54	K612	056B34F5306	✓	190
J034	SEE C331		121	K122	5K46MN4072	✓	36	K275	5K33GN45	✓	169	K615	056B34F5312	✓	190
J035	SEE C333		121	K125	SEE K022		37	K277	5K46KN4085	✓	169	K618	056B34F5318	✓	190
J036	SEE C335		121	K126	SEE K025		37	K278	5K46MN4087	✓	169	K622	5K49RN8424	✓	40
J037	SEE C337		121	K136	SEE C1157		24,167	K279	5K49PN3053	✓	169	K622A	145TTDR14049	✓	40
J038	SEE C339		121	K151	5K32GN30	✓	47	K280	5K49PN3052	✓	169	K631	056B34F5324		32
J039	SEE C341		121	K152	056B34D5320	✓	25	K281	5K32GN48	✓	168	K633	5K36MN4152	✓	51
J040	SEE K748		122	K153	5K33FN30	✓	47	K282	5K35MN294	✓	168	K634	5K46MN8423	✓	40
J041	SEE K217		122	K154	5K49FN4136	✓	47	K283	5K33KN52	✓	168	K634A	143TTDR14049	✓	40
J042	SEE KG219		122	K155	5K36PN30	✓	47	K284	5K42HN4128	✓	168	K635	5K46MN4623	✓	41
J043	SEE K221		122	K158	5K35MNB117	✓	47	K285	5K49MN6080	✓	168	K637	SEE P106		51,123
J044	SEE K223		122	K159	5K49MN6079	✓	47	K286	5K49KN4142	✓	168	K640	5K49QN4609	✓	52
J045	SEE K225		122	K160	5K37NN30	✓	47	K318	5K42JN4163	✓	36	K642	SEE P105		51,123
J046	SEE K227		122	K161	5K36PNB111	✓	47	K319	056B17F5319	✓	32,99,190	K644	5K49ZN4611	✓	40

## Catalog Number/Model Number

CAT. NO.	MODEL NO.	STOCK	PAGE NO.	CAT. NO.	MODEL NO.	STOCK	PAGE NO.	CAT. NO.	MODEL NO.	STOCK	PAGE NO.	CAT. NO.	MODEL NO.	STOCK	PAGE NO.
K646	5K49RN4617	✓	41	K1494	5K49RN4570	✓	97	K2085	SEE Y366		84	L455	449TTF80028		50
K648	5K49ZN4616	✓	41	K1497	5K49WN4335X	✓	169	K2087	SEE Y368		84	L456	449TTF80087	✓	50
K690	5K46HN2546	✓	41	K1500	5K49MN6432S	✓	161	K2088	SEE GT1209		64	L457	449TTF80077		50
K700	056T11F5328	✓	54	K1505	5K46LN6428S	✓	161	K2090	SEE K1491		51	L459	449TSTFS8002	✓	50
K701	056T11F5307	✓	53	K1510	5K49RN6429S		161	K2101	5K49FN6381X	✓	76	L460	SEE L462		50
K702	056T34T5309		53	K1511	5K48WN3181S	✓	161,173	K2102	5K49JN4582X	✓	76	L461	SEE L472A		50
K703	056T11T5316	✓	53	K1515	5K48TN6430S		161	K2103	5K49JN4560X	✓	76	L462	449TTF80037	✓	50
K704	056T34F5348	✓	53	K1520	5K49ZN6433S	✓	161	K2104	5K49HN6385X	✓	76	L463	449TTF80027	✓	50
K705	056T11F5336	✓	53	K2001	SEE E783		37	K2105	5K49JN4574X	✓	76	L464	449TTF80086	✓	50
K706	056T34F5349	✓	53	K2002	SEE U246		42	K2106	SEE G661		76	L465	449TTF80076		50
K707	056T11F5337	✓	53	K2003	SEE E784		37	K2107	5K49MN8349X	✓	76	L466	449TSTFS8001	✓	50
K708	056T34F5350	✓	53	K2004	SEE U1248		43	K2108	SEE G662		76	L467	449TTF80036	✓	50
K709	056T11F5338	✓	53	K2005	SEE U758		42	K2109	SEE G663		76	L469	SEE L469A		50
K717	5K32GNB249X	✓	76	K2006	SEE U759		42	K2110	5K49TN6383X	✓	76	L469A	449TTF814043	✓	50
K718	SEE G647		76	K2007	SEE U760		42	K2111	5K49NN4580X	✓	76	L471	449TTF818105		50
K721	056T34F5351	✓	54	K2010	SEE E914A		37	K2112	5K49JN4576X	✓	77	L472	SEE L472A		50
K722	056T11F5339	✓	54	K2011	SEE E2109		59	K2113	SEE G840		77	L472A	—		50
K723	056T34F5352	✓	54	K2012	SEE E2101		58	K2114	SEE G841		77	L633	SEE U605A		48
K724	056T11F5340	✓	54	K2013	SEE E2126		58	K2115	5K49NN4581X	✓	77	M101	SEE U123A		135
K725	056T34F5353	✓	54	K2014	SEE E2104		58	K2116	5K49MN6382X	✓	76	M102	SEE U126		135
K748	5K35FN101	✓	122	K2015	SEE E838		48	K2201	SEE I502		76	M103	SEE U129A		135
K750	5K46MN4144	✓	122	K2016	SEE E2107		59	K2202	SEE I504		76	M105	SEEU135A		135
K751	5K49PN4121	✓	122	K2017	SEE E847		48	K2203	SEE I506		76	M109	SEE U147A		135
K803	SEE K500		53	K2018	5KE49PN8418	✓	40	K2205	SEE I512		76	M110	SEE U150A		135
K806	056T11F5330	✓	54	K2019	SEE C102		40	K2206	SEE I514		76	M111	SEE U153		136
K1221	SEE K700		54	K2020	SEE C103		40	KG215	5K35FN55	✓	40,122,172	M113	SEE U159A		136
K1222	SEE K701		53	K2021	5KE49PN8391		41	KG219	5K37MN38	✓	122	M114	SEE U165A		136
K1299	5K46MN6018	✓	40	K2022	5KE49TN8401	✓	41	KG232	5K36MN339	✓	123	M115	SEE M115A		136
K1300	5K49PN6019	✓	40	K2023	5KE49UN8407	✓	41	KG234	5K38RN49	✓	123	M115A	184TTDW7358	✓	136
K1305	5K42FN4033	✓	41	K2024	SEE C150A		40	KG235	5K49PN2348	✓	51	M116	SEE U177A		136
K1306	5K49FN2045	✓	41	K2025	SEE C201A		51	KG236	5K49PN2330	✓	123	M117	SEE U183		136
K1307	5K42HN4032	✓	41	K2026	SEE U733		64	KG237	5K49SN2187	✓	51	M118	SEE U189A		137
K1308	5K46KN4031	✓	41	K2027	SEE C202A		51	KG319	5K49UN8052	✓	191	M119	SEE U195		137
K1311	5K49NN2046	✓	41	K2028	SEE GT1206		64	L102	SEE E1904		38	M120	SEE U201A		137
K1314	SEE G586		53	K2029	SEE C220A		51	L409	SEE L409A		49	M121	SEE U207		137
K1315	SEE G587		53	K2030	5KE49TN8384T		169	L409A	182TTFN4101	✓	49	M122	SEE U210		137
K1316	5K49MN6020	✓	51	K2031	SEE GT1204		64	L410	SEE L410A		49	M123	SEE U213		137
K1317	5K49PN6025	✓	51	K2032	SEE GT1201		64	L410A	184TTF814101	✓	49	M124	SEE U219		137
K1318	5K49PN8030	✓	51	K2033	5KE48WN8365	✓	51	L410B	184TTFN4102	✓	49	M125	SEE U225		137
K1322	5K42FN4035	✓	53	K2034	SEE GT1207		64	L411	SEE L411A		49	M126	SEE U228A		138
K1323	SEE D391		53	K2035	SEE C250		51	L411A	213TTFN4103	✓	49	M127	SEE U231		138
K1324	5K42HN4034	✓	53	K2036	SEE GT1202		64	L412	SEE L412A		49	M128	SEE U234		138
K1325	SEE G588		53	K2037	5KE49UN8376T		169	L412A	254TTFNA14103	✓	49	M129	SEE U236		138
K1326	SEE G589		53	K2038	5KE49QN8375T		169	L413	SEE L413A		49	M130	SEE U238		138
K1328	SEE D394		54	K2039	SEE GT1201		64	L413A	256TTFNA14101	✓	49	M131	SEE U242		138
K1402	5K39SNB505S	✓	161	K2040	5KE49UN8370T		169	L414	SEE L414A		49	M133	SEE U240		138
K1403	5K36PN345S	✓	161	K2042	SEE C236A		52	L414A	284TTFNA14102	✓	49	M163	SEE U299		136
K1404	5K38SN267S	✓	161	K2043	5KE49UN8428	✓	40	L415	SEE L415A		49	M165	SEE U186A		136
K1405	5K39SNB765T	✓	161	K2045	5KE49WN4571	✓	97	L415A	286TTFNA14106	✓	49	M166	SEE U192		137
K1407	5K39SNB587S	✓	161	K2046	5KE49WN4572	✓	97	L416	SEE L416A		50	M167	SEE U198A		137
K1408	5K42HN4089X	✓	169	K2048	SEE C221A		51	L416A	324TTF814101	✓	50	M168	SEE U204		137
K1409	5K37MN252X	✓	169	K2049	SEE E2106		59	L417	SEE L417A		50	M170	SEE U159A		136
K1410	5K46KN4085X	✓	169	K2051	SEE N323		106	L417A	326TTF814101	✓	50	M171	SEE U162A		136
K1411	5K38PN258X	✓	169	K2052	SEE N321A		106	L420	364TTF8101	✓	50	M172	SEE U165A		136
K1412	5K46MN4087X		169	K2053	SEE N312A		106	L421	SEE L421A		49	M213	SEE U345A		138
K1413	5K49KN2150X	✓	169	K2055	5KE49TN8378	✓	107	L421A	215TTF814103	✓	49	M216	SEE U372		138
K1415	5K49PN4088X	✓	169	K2056	5KE48WN8364	✓	107	L425	365TTF8115	✓	50	M217	SEE U366		138
K1416	5K49NN2147X	✓	169	K2058	SEE N607		108	L426	404TTF8102	✓	50	M301	SEE E100		125
K1418	5K49UN4086X	✓	169	K2059	SEE N629		108	L427	405TTF8114	✓	50	M302	SEE E118		125
K1438	5K49NN4052T	✓	104	K2060	SEE N610		108	L428	444TTF8106		50	M303	SEE E123		125
K1476	5K49JN4051T	✓	104	K2061	SEE N612A		108	L429	445TTFN8115	✓	50	M304	SEE E095		125
K1482	5K48WN3013S	✓	161,173	K2062	SEE N630		108	L440	445TTFN8102		50	M305	SEE E102		125
K1483	5K37MN3543	✓	122	K2063	SEE N613A		108	L442	449TTF8111		50	M306	SEE E128		125
K1484	5K46KN2082	✓	122	K2064	SEE G347		47	L449	449TTF8110	✓	50	M307	SEE E096		125
K1485	5K49RN6118S		160	K2065	SEE N611		108	L450	SEE L451A		50	M308	SEE E133		125
K1486	5K48TN6119S	✓	160,173	K2066	5KE48WN4593	✓	107	L451	SEE L451A		50	M309	SEE E104		125
K1487	5K49MN6126T	✓	174	K2067	5KE49TN4597	✓	108	L451A	449TSTFS14007	✓	50	M310	SEE E138		125
K1490	5K49PN6164	✓	51	K2068	5KE49TN4592	✓	107	L452	445TTFN8040	✓	50	M311	145TTDRS315	✓	126
K1491	5K49ZN4253	✓	51	K2069	5KE49PN4594	✓	36	L453	445TTFN8041		50	M312	145TTDRS316	✓	126
K1492	5K49ZN4252	✓	48	K2084	SEE K2033		51	L454	449TTF80038	✓	50	M313	SEE E097		126

# Index

## Catalog Number/Model Number

CAT. NO.	MODEL NO.	STOCK	PAGE NO.	CAT. NO.	MODEL NO.	STOCK	PAGE NO.	CAT. NO.	MODEL NO.	STOCK	PAGE NO.	MODEL NO.	CAT. NO.	STOCK	PAGE NO.
M314	SEE E098		126	M804	SEE M804A		149	M846	SEE M846A		150	M893	256TTFNA7028		153
M315	SEE M1315		126	M804A	184TTDR4173		149	M846A	404TTDS4359		150	M894	SEE M894A		153
M316	SEE M1316		126	M805	SEE M805A		149	M847	SEE M847A		150	M894A	286TTFNA14085		153
M317	SEE M1317		126	M805A	215TTDW14087		149	M847A	444TTDS14086		150	M896	284TTFNA7508		153
M318	SEE E158A		126	M807	SEE M807A		149	M848	445TTDS7121		150	M897	SEE M897A		153
M319	SEE E109A		126	M807A	213TTDW14054		149	M849	SEE M849A		150	M897A	284TTFPA14048		153
M320	SEE E163A		126	M808	SEE M808A		149	M849A	404TTDS14005		150	M898	SEE M898A		153
M321	SEE E110		127	M808A	254TTDX14088		149	M850	SEE M850A		150	M898A	324TTFPA14089		153
M322	SEE E168		127	M810	SEE M810A		149	M850A	405TTDS14067		150	M899	SEE M899A		153
M323	SEE E111		127	M810A	215TTDW4071		149	M851	SEE M851A		150	M899A	326TTF14103		153
M324	SEE E173		127	M811	SEE M811A		149	M851A	445TTDS14087		150	M900	SEE M900A		153
M325	SEE E112		127	M811A	256TTDX4094		149	M852	505UTDS805		150	M900A	286TTFPA14011		153
M326	215TTDW7048	✓	127	M813	SEE M813A		149	M853	SEE M853A		150	M901	SEE M901A		153
M327	SEE E113		127	M813A	215TTDW14018		149	M853A	405TTDS14003		150	M901A	286TTFPA14063		153
M328	SEE E183		127	M814	SEE M814A		149	M854	SEE M854A		150	M902	SEE M902A		153
M329	SEE E114A		127	M814A	254TTDX14064		149	M854A	444TTDS14057		150	M902A	326TTF14087		153
M330	SEE E191		127	M815	SEE M815A		149	M855	SEE M855A		150	M904	SEE M904A		153
M331	SEE E197		128	M815A	284TTDR14082		149	M855A	445TTDS17084		150	M904A	324TTF14003		153
M332	SEE U103		128	M818	SEE M818A		149	M856	505UTDS819		150	M905	SEE M905A		153
M333	SEE U160		128	M818A	256TTDX14039		149	M857	SEE M857A		150	M905A	324TTFPA14065		153
M334	SEE U109A		128	M819	SEE M819A		149	M857A	444TTDS14003		150	M906	SEE M906A		153
M335	SEE U114		128	M819A	286TTDR14081		149	M858	SEE M858A		150	M906A	364TTF14087		153
M351	SEE U112		128	M820	SEE M820A		149	M858A	445TTDS14063		150	M907	365TTF17102		153
M352	SEE U116		128	M820A	324TTDR14104		149	M859	SEE M859A		150	M909	SEE M909A		153
M353	SEE E118		127	M821	SEE M821A		149	M859A	505UTDS14077		150	M909A	326TTFPA14049		153
M358	SEE U118		128	M821A	256TTDX4310		149	M860	505UTDS5820		150	M910	SEE M910A		153
M360	SEE E106A		126	M822	SEE M822A		149	M861	SEE M861A		150	M910A	365TTF14084		153
M361	SEE E148A		126	M822A	286TTDR14046		149	M861A	445TTDS14003		150	M912	SEE M912A		154
M362	SEE E107A		126	M823	SEE M823A		149	M862	SEE M862A		150	M912A	364TTF14003		154
M363	SEE E153A		126	M823A	324TTDR14080		149	M862A	445TTDS14062		150	M913	SEE M913A		154
M401	SEE U301		131	M824	SEE M824A		149	M863	SEE M863A		150	M913A	364TTF14058		154
M402	SEE U307		131	M824A	326TTDR14103		149	M863A	505UTDS3999		150	M914	SEE M914A		154
M403	SEE U310A		131	M825	SEE M825A		149	M864	---		150	M914A	404TTF14088		154
M404	SEE U313A		131	M825A	284TTDR14011		149	M866	SEE M866A		150	M916	SEE M916A		154
M405	SEE U316A		131	M826	SEE M826A		149	M866A	---		150	M916A	365TTF57923		154
M406	SEE U319A		131	M826A	286TTDR14042		149	M867	SEE M867A		150	M917	SEE M917A		154
M407	SEE U322A		131	M828	SEE M828A		149	M867A	---		150	M917A	365TTF14060		154
M408	SEE U325A		131	M828A	364TTDR14104		149	M868	---		150	M918	SEE M918A		154
M409	SEE U329		131	M829	286TTDR17009		149	M869	SEE M869A		150	M918A	405TTF14087		154
M410	SEE U334		131	M830	SEE M830A		149	M869A	---		150	M919	444TTF57403		154
M411	SEE U337		132	M830A	324TTDR14049		149	M870	---		150	M920	405TTF57612		154
M412	SEE U340		132	M831	SEE M831A		149	M871	SEE M871A		150	M921	SEE M921A		154
M413	SEE U344		132	M831A	364TTDS14081		149	M871A	---		150	M921A	405TTF14063		154
M414	SEE U351		132	M832	SEE M832A		149	M873	---		150	M922	SEE M922A		154
M415	SEE U304A		131	M832A	365TTDS14101		149	M874	---		150	M922A	444TTFN14080		154
M416	SEE U360		131	M833	SEE M833A		149	M875	SEE M875A		153	M924	444TTF57321		154
M416A	SEE U360		131	M833A	324TTDR14010		149	M875A	182TFW14005		153	M925	SEE M925A		154
M417	SEE U357		132	M834	SEE M834A		149	M876	SEE M876A		153	M925A	444TTFN14044		154
M418	SEE U363		131	M834A	326TTDR14034		149	M876A	182TFW14026		153	M926	SEE M926A		154
M420	SEE U348		132	M835	SEE M835A		149	M877	SEE M877A		153	M926A	445TTFN14086		154
M421	SEE U348		132	M835A	365TTDS14082		149	M877A	213TFW14080		153	M928	SEE M928A		154
M422	SEE U319A		131	M836	SEE M836A		149	M879	SEE M879A		153	M928A	445TTFN14003		154
M423	SEE U322A		131	M836A	404TTDS14102		149	M879A	184TFW14026		153	M929	SEE M929A		154
M717	---		150	M837	SEE M837A		150	M880	SEE M880A		153	M929A	445TTFN14326		154
M718	256TTDN16053		150	M837A	326TTDR14010		150	M880A	215TFW14083		153	M931	449TTF57109		154
M719	---		150	M838	SEE M838A		150	M881	SEE M881A		153	M933	SEE M933A		154
M721	---		150	M838A	364TTDR14032		150	M881A	213TFW14010		153	M933A	445TTFN14330		154
M722	256TTDN16011		150	M839	SEE M839A		150	M883	SEE M883A		153	M1114	SEE U165A		136
M723	---		150	M839A	404TTDS14081		150	M883A	254TTFNA14084		153	M1116	SEE U177A		136
M741	---		150	M840	405TTDS7124		150	M884	SEE M884A		153	M1216	SEE U372		138
M742	365TTDS16072		150	M841	SEE M841A		150	M884A	215TFW14021		153	M1314	SEE E098		126
M743	---		150	M841A	364TTDS14011		150	M885	SEE M885A		153	M1315	182TTDB7325	✓	126
M749	---		150	M842	SEE M842A		150	M885A	215TFW14040		153	M1316	182TTDB7601	✓	126
M750	405TTDS16070		150	M842A	365TTDS4328		150	M886	SEE M886A		153	M1317	184TTDW7357	✓	126
M801	SEE M801A		149	M843	SEE M843A		150	M886A	256TTFNA14084		153	M1318	SEE E158A		126
M801A	182TTDR14027		149	M843A	405TTDS4376		150	M888	254TTFNA7012		153	M1319	SEE E109A		126
M802	SEE M802A		149	M844	SEE M844A		150	M890	SEE M890A		153	M1320	SEE E163A		126
M802A	213TTDW14084		149	M844A	444TTDS14101		150	M890A	284TTFPA14049		153	M1322	213TTDBA7048	✓	127
M803	SEE M803A		149	M845	SEE M845A		150	M892	SEE M892A		153	M1323	SEE E111		127
M803A	182TTDR14026		149	M845A	365TTDS14009		150	M892A	256TTFNA14016		153	M1327	SEE E113		127



## Catalog Number/Model Number

CAT. NO.	MODEL NO.	STOCK	PAGE NO.	CAT. NO.	MODEL NO.	STOCK	PAGE NO.	CAT. NO.	MODEL NO.	STOCK	PAGE NO.	CAT. NO.	MODEL NO.	STOCK	PAGE NO.
M1407	SEE U322A		131	N155	145TTWD14032	✓	116	N318A	213TTWR6027	✓	106	N433	056T17WD5330	✓	111
M1408	SEE U325A		131	N156	145TTWD14003	✓	116	N319	SEE N319A		106	N434	SEE N434A		111
M1420	---		151	N157	182TTWD14033	✓	116	N319A	215TTWR6027	✓	106	N434A	143TTWD4527	✓	111
M1421	---		151	N158	184TTWD14003	✓	116	N320	056T17W5340	✓	106	N435	056T17WD5331	✓	111
M1422	---		151	N159	184TTWD14033	✓	116	N321	SEE N321A		106	N436	---	✓	111
M1423	---		151	N160	213TTWD14002	✓	116	N321A	145TTWR6029	✓	106	N437	056T17WD5332	✓	111
M1424	---		151	N161	213TTWD14032	✓	116	N322	056T17W5344	✓	106	N438	SEE N438A		111
M1425	---		151	N162	215TTWD14002	✓	116	N323	145TTWR6076	✓	106	N438A	145TTWD4528	✓	111
M1426	---		151	N163	215TTWD14032	✓	116	N324	145TTWR16002	✓	106	N439	---	✓	111
M1427	---		151	N180	056T11V5379	✓	115	N325	213TTWW16002	✓	106	N441	056T34V5314	✓	115
M1428	---		151	N181	056T11V5380	✓	115	N340	---	✓	110	N442	056T34V5312	✓	115
M1429	---		151	N182	056T11W5379	✓	115	N341	---	✓	110	N443	056T34V5315	✓	115
M1430	---		151	N183	056T11W5380	✓	115	N342	---	✓	110	N444	143TTWD16002	✓	115
M1431	---		151	N201	143TTWR14032	✓	109	N343	---	✓	110	N445	145TTWD16003	✓	115
M1432	---		151	N202	143TTWR14002	✓	109	N344	---	✓	110	N446	145TTWD16002	✓	115
M1433	---		151	N203	143TTWR14031	✓	109	N345	---	✓	110	N447	184TTWD16002	✓	115
M1434	---		151	N204	145TTWR14003	✓	109	N346	---	✓	110	N448	213TTWD16002	✓	115
M1435	---		151	N205	145TTWR14031	✓	109	N347	---	✓	110	N449	215TTWD16002	✓	115
M1436	---		151	N206	145TTWR14004	✓	109	N348	---	✓	110	N450	056T34VD5301	✓	112
M1437	---		151	N207	182TTWW14031	✓	109	N349	---	✓	110	N451	056T34VD5302	✓	112
M1438	---		151	N208	184TTWW14005	✓	109	N351	056T17V99006	✓	109	N452	056T34VD5303	✓	112
M1439	---		151	N209	184TTWW14031	✓	109	N353	056T17V99007	✓	109	N453	056T34WD5301	✓	112
M1440	---		152	N210	184TTWW14004	✓	109	N355	056T17V99008	✓	109	N454	SEE N454A		112
M1441	---		152	N211	213TTWW14031	✓	109	N357	056T17V99005	✓	109	N454A	143TTWD6001	✓	112
M1442	---		152	N212	215TTWW14009	✓	109	N358	143TTVR5331	✓	109	N455	056T34WD5302	✓	112
M1443	---		152	N213	215TTWW14031	✓	109	N360	145TTWR14032	✓	109	N456	143TTWD4002	✓	112
M1444	---		152	N214	215TTWW14007	✓	109	N362	145TTWR14033	✓	109	N456A	143TTWD6002	✓	112
M1445	---		152	N220	056T34W99003	✓	109	N371	056T17V99003	✓	109	N457	056T34WD5303	✓	112
M1446	---		152	N222	056T34W99004	✓	109	N373	056T17V99004	✓	109	N458	SEE N458A		112
M1447	---		152	N224	056T34W99005	✓	109	N375	056T17V99002	✓	109	N458A	145TTWD6001	✓	112
M1448	---		152	N226	056T34W99006	✓	109	N377	056T17V99009	✓	109	N459	---	✓	112
M1449	---		152	N228	056T34W99009	✓	109	N378	143TTVR5330	✓	109	N460	048T17V2001	✓	114
M1450	---		152	N230	056T34W99007	✓	109	N380	145TTWR17031	✓	109	N461	048T17V2002	✓	114
M1451	---		152	N232	056T34W99010	✓	109	N382	145TTWR17032	✓	109	N462	056T17V5353	✓	114
M1452	---		152	N234	056T34W99011	✓	109	N388	056T17V5354	✓	116	N463	056T17V5352	✓	114
M1453	---		152	N236	056T34W99008	✓	109	N389	056T17V5355	✓	116	N464	056T17V5356	✓	114
M1454	---		152	N238	056T34W99012	✓	109	N400	056T17V5347	✓	115	N465	056T17W5331	✓	114
M1455	---		152	N270	056C17V5304	✓	113	N401	056T17V5348	✓	115	N466	143TTVD5327	✓	114
M1456	---		152	N271	056C17V5302	✓	113	N402	056T17V5349	✓	115	N467	143TTWD14032	✓	114
M1457	---		152	N272	056B17V5301	✓	113	N403	143TTVD5326	✓	115	N468	056T17W5330	✓	114
M1458	---		152	N273	056B17V5302	✓	113	N404	SEE N404A		115	N469	145TTWD14034	✓	114
M1459	---		152	N274	145TBWD5327	✓	113	N404A	145TTWD6026	✓	115	N470	056T17W5332	✓	114
M1460	---		152	N275	145TBWD5326	✓	113	N405	SEE N405A		115	N471	145TTWD14033	✓	114
M1461	---		152	N280	056C17V5303	✓	113	N405A	145TTWD6027	✓	115	N472	182TTWD14032	✓	114
M1462	---		152	N281	056C34V5302	✓	113	N406	SEE N406A		115	N473	184TTWD14032	✓	114
M1463	---		152	N282	056C17V5301	✓	113	N406A	182TTWD6031	✓	115	N480	056T34V5316	✓	114
M1464	---		152	N283	056B17V5303	✓	113	N407	SEE N407A		115	N481	056T34V5317	✓	114
M1465	---		152	N284	056C34V5301	✓	113	N407A	184TTWD6031	✓	115	N482	056T34V5313	✓	114
M1466	---		152	N285	056B17V5304	✓	113	N408	SEE N408A		115	N483	143TTWD14003	✓	114
M1467	---		152	N286	056B34W5301	✓	113	N408A	213TTWD6031	✓	115	N484	145TTWD14005	✓	114
M1468	---		152	N287	145TBWD5329	✓	113	N409	SEE N409A		115	N485	145TTWD14004	✓	114
M1469	---		152	N288	145TBWD5301	✓	113	N409A	215TTWD6031	✓	115	N486	184TTWD14002	✓	114
M1470	---		152	N289	145TBWD5328	✓	113	N410	056T17VD5326	✓	112	N494	---		112
M1471	---		152	N291	056T17W5329	✓	115	N411	056T17VD5328	✓	112	N495	---		112
M1472	---		152	N292	143TTWD16031	✓	115	N412	056T17VD5327	✓	112	N496	---		112
M1473	---		152	N293	056T17W5336	✓	115	N413	056T17WD5326	✓	112	N497	---		112
M1474	---		152	N294	056T17W5337	✓	115	N414	SEE N414A		112	N498	---		112
M1475	---		152	N309	056T17V5346	✓	106	N414A	143TTWD6026	✓	112	N499	---		112
M1476	---		152	N310	143TTVR5329	✓	106	N415	056T17WD5329	✓	112	N523	056C17W5327	✓	105
M1477	---		152	N312	SEE N312A		106	N416	---	✓	112	N524	056C34W5303	✓	105
M1478	---		152	N312A	145TTWR6027	✓	106	N417	056T17WD5328	✓	112	N525	056C17W5328	✓	105
M1479	---		152	N313	056T17W5328	✓	106	N418	SEE N418A		112	N526	056C34W5304	✓	105
M1480	---		152	N314B	182TTWW6027	✓	106	N418A	145TTWD6029	✓	112	N527	056C17W5329	✓	105
M1481	---		152	N315	SEE N315A		106	N419	---	✓	112	N528	056C34W5305	✓	105
M1482	---		152	N315A	184TTWW6004	✓	106	N427	---	✓	111	N529	056C17W5330	✓	105
M1483	---		152	N316	SEE N316B		106	N428	---	✓	111	N530	056C34W5301	✓	105
N151	143TTWD14031	✓	116	N316B	184TTWW6027	✓	106	N429	---	✓	111	N531	056C17W5326	✓	105
N152	143TTWD14002	✓	116	N317	SEE N317A		106	N430	056T17VD5329	✓	111	N532	056C34W5302	✓	105
N153	145TTWD14031	✓	116	N317A	184TTWW6003	✓	106	N431	056T17VD5330	✓	111	N540	056C34W5308	✓	105
N154	145TTWD14002	✓	116	N318	213TTWR4027	✓	106	N432	056T17VD5331	✓	111	N541	056C17W5333	✓	105

# Index

## Catalog Number/Model Number

CAT. NO.	MODEL NO.	STOCK	PAGE NO.	CAT. NO.	MODEL NO.	STOCK	PAGE NO.	CAT. NO.	MODEL NO.	STOCK	PAGE NO.	MODEL NO.	CAT. NO.	STOCK	PAGE NO.
N542	056C34W5309	✓	105	N651	056T34V5304	✓	107	O005	048S34S2004	✓	171	R309	071T34FH5302	✓	94
N543	056C17W5334	✓	105	N652	145TTWR5301	✓	107	O010	048C34D2024	✓	171	R310	080T17FH5326	✓	94
N544	056C34W5310	✓	105	N653	056T17W5326	✓	107	O011	048C34D2028	✓	171	R311	080T11FH5378	✓	94
N545	056C17W5335	✓	105	N654	SEE N654A		107	O012	048C34S24	✓	171	R312	080T34FH5301	✓	94
N546	056C34W99003	✓	105	N654A	145TTWR4326	✓	107	O013	048C34S2001		171	R313	080T17FH5327	✓	94
N556	056C34W5306	✓	105	N655	145TTWR5301	✓	107	O014	SEE O010		171	R314	SEE R314A		94
N557	056C17W5331	✓	105	N655A	145TTWR4301	✓	107	O100	048S34S361	✓	171	R314A	090ST11FH6376	✓	94
N558	056C34W5307	✓	105	N656	SEE N656B		107	O102	048S34S2005	✓	171	R315	080T34FH5302	✓	94
N559	056C17W5332	✓	105	N656B	182TTWW4028	✓	107	O200	056S34D2000	✓	172	R316	SEE R316A		94
N564	056T17V5332	✓	108	N657	SEE N657B		107	O201	056S34D93	✓	172	R316A	090ST17FH6326	✓	94
N566	056T34V5305	✓	108	N657B	184TTWW4002	✓	107	O210	056C34D2114	✓	172	R317	100LTC6586	✓	94
N567	056T17V5336	✓	108	N658	SEE N658B		107	O211	056C34D2109	✓	172	R318	SEE R318A		94
N568	056T11V5376	✓	108	N658B	184TTWW4028	✓	107	O212	056C34D2098	✓	172	R318A	090ST34FH6301	✓	94
N569	056T34V5306	✓	108	N659	SEE N659A		107	O213	056C34D2099	✓	172	R319	SEE R319A		94
N599	056T17V5338	✓	108	N659A	213TTWR4001	✓	107	O214	056C34D2104	✓	172	R319A	090L17FH6326	✓	94
N600	056T11V5377	✓	108	N660	213TTWR7026	✓	107	O215	056C34D2112	✓	172	R320	SEE R320A		94
N601	056T34V5307	✓	108	N661	215TTWR7026	✓	107	O217	056C34D2105	✓	172	R320A	100LTC6576	✓	94
N602	056T17V5340	✓	108	N662	056T34V99001	✓	107	O231	056B34D2028	✓	172	R321	SEE R321A		95
N604	056T11W5377	✓	108	N663	—		107	O232	056B34D5337		172	R321A	090L34FH6301	✓	95
N605	056T34V5308	✓	108	N664	215TTWW14008	✓	107	O600	048S17T286	✓	171	R322	SEE R322A		95
N606	056T17V5342	✓	108	N665	056T34V99001	✓	107	O601	048S17T290	✓	171	R322A	100LTC6526	✓	95
N607	145TTWR5326	✓	108	N666	056T17W99003	✓	107	O701	048A34SU1001	✓	171	R323	SEE R323A		95
N608	056T11W5378	✓	108	N667	056T34V99002	✓	107	P001	SEE KG215		40,122,172	R323A	112MTFC6576	✓	95
N609	056T34V5309	✓	108	N668	056T17W99006	✓	107	P002	SEE K216		40,122,172	R324	SEE R324A		95
N610	145TTWR5302	✓	108	N669	056T17W99002	✓	107	P003	SEE K218		40,122,172	R324A	112MTFC6511	✓	95
N611	056T17W5327	✓	108	N680	056C17W5336	✓	105	P004	SEE K220		40,122,172	R325	SEE R325A		95
N612	SEE N612A		108	N681	056C17W5337	✓	105	P005	SEE K222		40,122,172	R325A	112MTFC6536	✓	95
N612A	145TTWR6026	✓	108	N682	056C17W5338	✓	105	P006	SEE K224		40,122,172	R326	SEE R326A		95
N613	SEE N613A		108	N683	145TCWR5326	✓	105	P007	SEE K226		40,122,172	R326A	132MTFC6586	✓	95
N613A	145TTWR6001	✓	108	N684	182TCWR7026	✓	105	P101	056T34T5306	✓	51,123	R327	SEE R327A		95
N614	SEE N614B		108	N685	143TCWR17031	✓	105	P102	056T34F5321	✓	51,123	R327A	132STFC6501	✓	95
N614B	182TTWW6026	✓	108	N701	048T17V11001	✓	118	P103	056T34F5322	✓	51,123	R328	SEE R328A		95
N615	SEE N615B		108	N703	056T34V99013	✓	118	P104	056T34F5323	✓	51,123	R328A	132STFC6526	✓	95
N615B	184TTWW6001	✓	108	N704	048T17V11002	✓	118	P105	056T34F5324	✓	51,123	R329	SEE R329A		95
N616	SEE N616B		108	N705	056T17V99016	✓	118	P106	056T34F5325	✓	51,123	R329A	132MTFC6587	✓	95
N616B	184TTWW6026	✓	108	N707	056T34V99014	✓	118	P107	056T34F5326	✓	52,123	R330	SEE R330A		95
N617	SEE N617A		108	N708	056T17V99011	✓	118	P180	5KCP49WN9813S	✓	159	R330A	132STFC6502	✓	95
N617A	213TTWR6002	✓	108	N710	056T34V99011	✓	118	P184	5KCP49UN9612S	✓	159	R331	SEE R331A		95
N618	SEE N618A		108	N711	056T17V99012	✓	118	P185	5KCP49UN9614S	✓	159	R331A	132MTFC6536	✓	95
N618A	213TTWR6026	✓	108	N713	143TTWD16004	✓	118	P190	5KCP49ZN9617T	✓	157	R332	SEE R332A		95
N619	SEE N619A		108	N715	056T17W99007	✓	118	P193	5KCP39SNB480S		159	R332A	160MTFC6586	✓	95
N619A	215TTWR6026	✓	108	N716	143TTWD16033	✓	118	P194	5KCP39SNB481S		159	R333	SEE R333A		95
N620	SEE N620A		108	N718	145TTWD16004	✓	118	P195	5KCP39SNB482S	✓	159	R333A	160MTFC6511	✓	95
N620A	056T17V15501	✓	108	N720	145TTWD16032	✓	118	P196	5KCP39TNB763T	✓	159	R334	SEE R334A		95
N621	056T17W5335	✓	108	N721	056T17W99009	✓	118	P197	5KCP39UNB767T	✓	159	R334A	160MTFC6536	✓	95
N622	056T17V5337	✓	108	N753	056T34V99012	✓	118	P198	5KCP39UNB764T	✓	159	R335	SEE R335A		95
N623	056T17W5339		108	N755	056T17V99015	✓	118	P239	5KCP33GNA471S	✓	104	R335A	160LTC6588	✓	95
N626	SEE N626A		108	N757	056T34V99015	✓	118	P240-(GE)	SEE PG240		174	R336	SEE R336A		95
N626A	143TTWR6028	✓	108	N758	056T17V99014	✓	118	P241	5KCP36RNA491S	✓	174	R336A	160MTFC6512	✓	95
N627	056T17W5341	✓	108	N760	056T34V99016	✓	118	P243	5KCP49RN9611S	✓	159	R337	SEE R337A		95
N628	056T17W5334	✓	108	N761	056T17V99013	✓	118	P244	5KCP49UN9613S	✓	159	R337A	160LTC6538	✓	95
N629	145TTWR5030	✓	108	N763	143TTWD16003	✓	118	P245	5KCP49PN9812S	✓	159	R338	SEE R338A		95
N630	145TTWR6033	✓	108	N765	056T17W99010	✓	118	P246	5KCP49UN9811S	✓	159	R338A	180LTC6588	✓	95
N631	056T34W99002	✓	108	N766	143TTWD16032	✓	118	P247	5KCP35NNA670T	✓	186	R339	SEE R339A		95
N632	056T17W99005	✓	108	N768	145TTWD16005	✓	118	P250	5KCP35KNB057S	✓	102	R339A	160LTC6513	✓	95
N633	056T17W99004	✓	108	N770	056T17W99008	✓	118	P251	5KCP36NNB059S	✓	102	R340	SEE R340A		95
N634	182TTWW16002	✓	108	N771	145TTWD16031	✓	118	P252-(GE)	SEE PG252		186	R340A	180MTFC6536	✓	95
N635	184TTWW16002	✓	108	N1314	SEE N314B		106	P253	5KCP36NNB671U	✓	186	R341	SEE R341A		95
N637	215TTWW16003	✓	108	N1315	SEE N315A		106	P254	5KCP35KNB650U	✓	186	R341A	200LTC6588	✓	95
N640	056T17V5326	✓	107	N1316	SEE N316B		106	PG240	5KCP35CNA490S	✓	174	R342	SEE R342A		95
N641	056T17V5327	✓	107	N1317	SEE N317A		106	PG252	5KCP36NNB670U	✓	186	R342A	180MTFC6511	✓	95
N642	056T17V5328	✓	107	N1614	182TTWW4026	✓	108	R300	06T34FH5301	✓	94	R343	SEE R343A		95
N643	056T34V5301	✓	107	N1615	SEE N615B		108	R301	063T17FH5326	✓	94	R343A	180LTC6538	✓	95
N644	056T17V5329	✓	107	N1616	SEE N616B		108	R302	071T11FH5376	✓	94	R344	SEE R344A		95
N645	056T34V5302	✓	107	N1656	SEE N656B		107	R303	063T34FH5302	✓	94	R344A	200LTC6589	✓	95
N646	056T17V5330	✓	107	N1657	SEE N657B		107	R304	071T17FH5326	✓	94	R345	SEE R345A		95
N647	143TTWR5326	✓	107	N1658	SEE N658B		107	R305	080T11FH5376	✓	94	R345A	200LTC6511	✓	95
N648	056T34V5303		107	O002	048S17S25	✓	171	R306	071T34FH5301	✓	94	R346	SEE R346A		95
N649	056T17V5331	✓	107	O003	048S17S24	✓	171	R307	071T17FH5327	✓	94	R346A	200LTC6538	✓	95
N650	143TTWR5327	✓	107	O004	048S34S2003	✓	171	R308	080T11FH5377	✓	94	R347	SEE R347A		95

## Catalog Number/Model Number

CAT. NO.	MODEL NO.	STOCK	PAGE NO.	CAT. NO.	MODEL NO.	STOCK	PAGE NO.	CAT. NO.	MODEL NO.	STOCK	PAGE NO.	CAT. NO.	MODEL NO.	STOCK	PAGE NO.
R347A	225MTFC6586	✓	95	R410	080T17FH5330	✓	94	S037	056C17D5319	✓	23	U003A	145TTGN6527	✓	79
R348	SEE R348A		95	R412	080T34FH5305	✓	94	S038	056C17D5343	✓	23	U004	SEE U004A		79
R348A	200LTC6513	✓	95	R413	080T17FH5331	✓	94	S039	056C17D5320	✓	23	U004A	182TTGN6526	✓	79
R349	SEE R349A		95	R415	080T34FH5303	✓	94	S102	048S17D2042	✓	25	U005	SEE U005A		79
R349A	225TFC6526	✓	95	R416	SEE R416A		94	S103	048S17D2091		25	U005A	184TTGN6526	✓	79
R350	SEE R350A		95	R416A	090ST17FH6327	✓	94	S106	048S17D2093	✓	26	U006	SEE U006A		80
R350A	250MTFC6586	✓	95	R418	SEE R418A		94	S110	048C17D2028	✓	26	U006A	213TTGN6526	✓	80
R351	SEE R351A		95	R418A	090ST34FH6302	✓	94	S111	048C17D2029	✓	26	U007	SEE U007A		80
R351A	100LTC6501	✓	95	R419	090LT17FH5327	✓	94	S112	056C17D2097	✓	26	U007A	215TTGN6526	✓	80
R352	SEE R352A		95	R419A	090LT17FH6327	✓	94	S113	056C17D2099	✓	26	U008	SEE E503		80
R352A	100LTC6536	✓	95	R420A	100LTC6577	✓	94	S114	056C17D2060	✓	26	U009	SEE E506		80
R353	SEE R353A		95	R421	SEE R421A		95	S115	056C17D2061	✓	26	U010	SEE E547		80
R353A	132STFC6586	✓	95	R421A	090LT34FH6302	✓	95	S116	056C17D5339	✓	26	U011	SEE E564		80
R360	063T34FH5401	✓	96	R422A	100LTC6527	✓	95	S117	056C17D5340	✓	26	U012	SEE E567		80
R361	063T17FH5402	✓	96	R424	SEE R424A		95	S118	048C17D2045	✓	25	U013	SEE E570		80
R362	071T11FH5403	✓	96	R424A	112MTFC6512	✓	95	S119	048C17D2046	✓	25	U018	SEE E585		81
R363	063T34FH5404	✓	96	R425	SEE R425A		95	S120	056S17D2023	✓	26	U019	SEE E588		81
R364	071T17FH5405	✓	96	R425A	112MTFC6537	✓	95	S126	048S17D2104	✓	25	U020	143TTGN4030		78
R365	080T11FH5406	✓	96	R427A	132STFC6503	✓	95	S127	048S17D2105	✓	26	U020A	143TTGN6530	✓	79
R366	071T34FH5407	✓	96	R428	SEE R428A		95	S128	048S17D2106	✓	26	U021	145TTGN4035		78
R367	071T17FH5408	✓	96	R428A	132STFC6527	✓	95	S501	145TTTN18577		187	U021A	145TTGN6537	✓	79
R368	080T11FH5409	✓	96	R430A	132STFC6504	✓	95	S503	145TTTN18531		187	U022	145TTGN4040		78
R369	071T34FH5410	✓	96	R431	SEE R431A		95	S504	184TTTS18577		187	U022A	145TTGN6540	✓	79
R370	080T17FH5411	✓	96	R431A	132MTFC6537	✓	95	S506	182TTTS18532		187	U023	182TTGS4030		78
R371	080T11FH5412	✓	96	R451	SEE R451A		95	S507	213TTTS17077		187	U023A	182TTGN6530	✓	79
R372	080T34FH5413	✓	96	R451A	100LTC6502	✓	95	S510	215TTTS17077	✓	187	U024	184TTGS4030		78
R373	080T17FH5414	✓	96	R452	SEE R452A		95	S513	254TTTNA17077	✓	187	U024A	184TTGN6530	✓	79
R374	SEE R374A		96	R452A	100LTC6537	✓	95	S516	256TTTNA18578	✓	187	U025	213TTGS4030		78
R374A	090ST11FH6415	✓	96	R500	225MTFC6501	✓	95	S517	284TTTNA18601		187	U025A	213TTGN16537	✓	80
R375	080T34FH5416	✓	96	R501	225MTFC6526	✓	95	S518	254TTTNA18530		187	U026	215TTGS4030		78
R376	SEE R376A		96	R502	280STFC6586	✓	95	S519	284TTTNA16577		187	U026A	215TTGN16532	✓	80
R376A	090ST17FH6417	✓	96	R503	250MTFC6501	✓	95	S522	286TTTNA18577		187	U027	254TTGN4030		78
R377	SEE R377A		96	R504	250MTFC6526	✓	95	S523	324TTTS18601		187	U027A	254TTGN16541	✓	80
R377A	090ST34FH6418	✓	96	R505	280MTFC6588	✓	95	S525	324TTTS18577		187	U028	256TTGN4030		78
R378	SEE R378A		96	R506	280STFC6501	✓	95	S528	326TTTS18577		187	U028A	256TTGN16540	✓	80
R378A	090LT17FH6419	✓	96	R507	280STFC6526	✓	95	S553	145TTTN18532		187	U029	284TTGP4030		78
R379	SEE R379A		96	R508	315STFC6588	✓	95	S554	184TTTS18578		187	U029A	284TTGN16539	✓	80
R379A	090LT34FH6420	✓	96	R700	071T17V5326	✓	117	S557	213TTTS17078		187	U030	286TTGP4030		78
R380	063T34FH5501	✓	96	R701	080T17V5326	✓	117	S560	215TTTS17078	✓	187	U030A	286TTGN16533		80
R381	063T17FH5502	✓	96	R702	071T17V5327	✓	117	S564	256TTTNA18601		187	U031	324TTGP4030		78
R382	071T11FH5503	✓	96	R703	080T17V5331	✓	117	S566	256TTTNA18577		187	U031A	324TTGS16535		80
R383	063T34FH5504	✓	96	R704	080T17V5326	✓	117	S567	284TTTNA17101	✓	187	U032	326TTGP4030		78
R384	071T17FH5505	✓	96	R705	090LT17W4026	✓	117	S569	284TTTNA18577		187	U032A	326TTGS16539		80
R385	080T11FH5506	✓	96	R706	090LT17W4027	✓	117	SY001	056PNRA10100	✓	91	U033	364TTGS4040		78
R386	071T34FH5507	✓	96	R707	090LT17W4028	✓	117	SY003	056PNRA10101	✓	91	U033A	364TTGS16537		80
R387	071T17FH5508	✓	96	R710	080T17V5327	✓	117	SY004	056PNRA10102	✓	91	U034	365TTGS4040		78
R388	080T11FH5509	✓	96	R711	080T17V5333	✓	117	SY005	056PNRA10103	✓	91	U034A	365TTGS16542		81
R389	071T34FH5510	✓	96	R712	080T17V5327	✓	117	SY006	182TPFSA10094	✓	91	U035	405TTGS4040		78
R390	080T17FH5511	✓	96	R720	071T17V5328	✓	117	SY007	184TPFSA10095	✓	91	U035A	405TTGS16539		81
R391	080T11FH5512	✓	96	R721	080T17V5328	✓	117	SY008	213TPFSA10096	✓	91	U036	444TTGS4042		78
R392	080T34FH5513	✓	96	R722	071T17V5329	✓	117	SY009	215TPFSA10097	✓	91	U036A	444TTGN16533		81
R393	080T17FH5514	✓	96	R723	080T17V5329	✓	117	SY010	254TPFSA10088	✓	91	U037	445TTGN4030		78
R394	SEE R394A		96	R724	080T17V5328	✓	117	SY011	256TPFSA10087	✓	91	U037A	445TTGN16544		81
R394A	090ST11FH6515	✓	96	R730	080T17V5330	✓	117	SY012	284TPFSA10112	✓	91	U038	445TTGN4045		78
R395	080T34FH5516	✓	96	R731	080T17V5332	✓	117	SY013	286TPFSA10090	✓	91	U038A	445TTGN16543		81
R396	SEE R396A		96	R732	080T17V5329	✓	117	T010	056C17F5351	✓	191	U039	SEE U039A		79
R396A	090ST17FH6517	✓	96	S003	048S17D2089	✓	23	T013	056C34F5340	✓	191	U039A	145TTGN6576	✓	79
R397	SEE R397A		96	S006	048S17D2090	✓	23	T014	056C17F5350	✓	191	U040	SEE U040A		79
R397A	090ST34FH6518	✓	96	S010	048C17D2023	✓	23	T015	056C34F5339	✓	191	U040A	182TTGN6576	✓	79
R398	SEE R398A		96	S011	048C17D2024	✓	23	T016	056C17F5349	✓	191	U041	SEE U041A		79
R398A	090LT17FH6519	✓	96	S012	056C17D2098	✓	23	T017	056B34F5332	✓	191	U041A	184TTGN6576	✓	79
R399	SEE R399A		96	S013	056C17D2051	✓	23	T018	056B17F5328	✓	191	U042	SEE U042		79
R399A	090LT34FH6520	✓	96	S014	056C17D2054	✓	23	T019	056B34F5333	✓	191	U042A	213TTGN6576	✓	79
R400	063T34FH5303	✓	94	S015	056C17D2055	✓	23	T030	056B17F5329	✓	191	U043	SEE U043A		79
R401	063T17FH5327	✓	94	S022	056S17D2046	✓	23	T031	145TBR5309	✓	191	U043A	215TTGN6576	✓	79
R403	063T34FH5304	✓	94	S026	048S17D2113		23	U001	SEE U001A		79	U044	SEE E500		80
R404	071T17FH5330	✓	94	S027	056S17D2066		23	U001A	143TTGN6526	✓	79	U045	SEE E501		80
R406	071T34FH5303	✓	94	S030	048C17D2027	✓	23	U002	SEE U002A		79	U046	SEE E504		80
R407	071T17FH5331	✓	94	S033	056C17D2064	✓	23	U002A	145TTGN6526	✓	79	U047	SEE E507		80
R409	071T34FH5304	✓	94	S036	056C17D2067	✓	23	U003	SEE U003A		79	U048	SEE U048A		80

# Index

## Catalog Number/Model Number

CAT. NO.	MODEL NO.	STOCK	PAGE NO.	CAT. NO.	MODEL NO.	STOCK	PAGE NO.	CAT. NO.	MODEL NO.	STOCK	PAGE NO.	MODEL NO.	CAT. NO.	STOCK	PAGE NO.
U048A	324TTGS16577	✓	80	U110	284TTDP4023	✓	128	U171A	184TTDW4136		136	U237	286TTDP4024		138
U049	SEE E565		80	U111	286TTDP4067		128	U172	184TDR4148		136	U238	324TDP4348	✓	138
U050	SEE E568A		80	U112	286TTDP4037		128	U173	184TDR4143		136	U239	324TDP4033		138
U055	SEE E583		81	U113	286TTDP4047		128	U175	184TDR4149		136	U240	324TDP4002	✓	138
U058	SEE U058A		79	U114	286TTDP4015	✓	128	U176	184TDR4117		136	U241	324TDP4011		138
U058A	143TTGN6501	✓	79	U115	286TTDP4021		128	U177	SEE U177A		136	U242	326TDP4340	✓	138
U059	SEE U059A		79	U116	324TDP4345		128	U177A	184TTDW14079	✓	136	U243	326TDP4032		138
U059A	145TTGN6501	✓	79	U117	324TDP4349		128	U178	184TDR4123		136	U244	056T34D6001	✓	42
U060	SEE U060A		79	U118	324TDP4004	✓	128	U179	184TDR4118		136	U245	143TDR6028	✓	42
U060A	182TTGN6501	✓	79	U119	324TDP4018		128	U180	184TDR4112		136	U246	145TDR6039	✓	42
U061	SEE U061A		79	U120	326TDP4329		128	U181	184TDR4124		136	U247	145TDR6002	✓	42
U061A	184TTGN6501	✓	79	U121	326TDP4326		128	U182	213TTDW4044		136	U249A	184TTDW6001	✓	43
U062	SEE U062A		80	U122	143TDR4042		135	U183	213TTDW4049	✓	136	U250	404TSDS6001	✓	44
U062A	213TTGN6501	✓	80	U123	SEE U123A		135	U184	213TTDW4039		136	U251	405TSDS6007	✓	44
U063	SEE U063A		80	U123A	143TDR14048		135	U185	213TTDW4051		136	U252	444TSDS16003	✓	44
U063A	215TTGN6501	✓	80	U124	143TDR4048		135	U186	SEE U186A		136	U254	254TDC6076	✓	43
U064	SEE E502		80	U125	143TDR4043		135	U186A	213TTDW14059		136	U255	256TDC6076	✓	43
U065	SEE E505		80	U126	143TDR4037		135	U187	213TTDW4052		136	U256	284TDC6076	✓	43
U066	SEE E546		80	U127	143TDR4049		135	U188	213TTDW4011		137	U257	286TDC6076	✓	43
U067	SEE E563		80	U128	143TDR4018		135	U189	SEE U189A		137	U265	145TDR6076	✓	42
U068	SEE E566		80	U129	SEE U129A		135	U189A	213TTDW14013	✓	137	U268	213TDC6076	✓	42
U069	SEE E569		80	U129A	143TDR14003	✓	135	U190	213TTDW4012		137	U269	215TDC6076	✓	43
U070	SEE E572		80	U130	143TDR4023		135	U191	213TTDW4013		137	U270	404TDS6086	✓	44
U071	SEE E575		81	U131	143TDR4019		135	U192	213TTDW4025		137	U271	405TDS16081	✓	44
U073	SEE U073A		81	U132	143TDR4011		135	U193	213TTDW4014		137	U272	444TDS16077	✓	44
U073A	444TSTGN16502		81	U133	143TDR4025		135	U194	215TTDW4044		137	U273	445TDS16076	✓	44
U074	SEE E584		81	U134	145TDR4042		135	U195	215TTDW4049	✓	137	U274	447TDS16077	✓	44
U075	SEE U075A		81	U135	SEE U135A		135	U196	215TTDW4051		137	U275	449TDS16076	✓	44
U075A	445TSTGN16506		81	U135A	145TDR4354	✓	135	U197	215TTDW4053		137	U279	213TDC6079	✓	42
U076	SEE U076A		80	U136	145TDR4048		135	U198	SEE U198A		137	U280	215TDC6079	✓	43
U076A	284TSTGN16531		80	U137	145TDR4043		135	U198A	215TTDW14073		137	U281	213TDC6029	✓	43
U077	SEE U077A		80	U138	145TDR4037		135	U199	215TTDW4052		137	U282	254TDC6079	✓	43
U077A	286TSTGN16531		80	U139	145TDR4049		135	U200	215TTDW4011		137	U283	213TDC6003	✓	43
U078	SEE U078A		80	U140	145TDR4017		135	U201	SEE U201A		137	U284	215TDC6029	✓	43
U078A	324TSTGS16531		80	U141	145TDR4011		135	U201A	215TTDW14020	✓	137	U285	256TDC6079	✓	43
U079	SEE U079A		80	U142	145TDR4023		135	U202	215TTDW4012		137	U286	215TDC6003	✓	43
U079A	326TSTGS16532		80	U143	145TDR4018		135	U203	215TTDW4013		137	U287	254TDC6029	✓	43
U080	SEE U080A		80	U144	145TDR4012		135	U204	215TTDW4025		137	U288	284TDC6079	✓	43
U080A	364TSTGS16531		80	U145	145TDR4024		135	U205	215TTDW4014		137	U289	254TDC6003	✓	43
U081	SEE U081A		81	U146	145TDR4068		135	U206	254TDX4074		137	U290	256TDC6029	✓	43
U081A	365TSTGS16532		81	U147	SEE U147A		135	U207	254TDX4075	✓	137	U291	256TDC6003	✓	43
U082	SEE U082A		81	U147A	145TDR4356	✓	135	U208	254TDX4340		137	U292	284TDC6003	✓	43
U082A	405TSTGS16531		81	U148	145TDR4074		135	U209	254TDX4060		137	U293	286TDC6003	✓	44
U083	SEE U083A		81	U149	145TDR4069		135	U210	254TDX4041	✓	137	U294	324TDC6003	✓	44
U083A	444TSTGN16531		81	U150	SEE U150A		135	U211	254TDX4341		137	U299	184TDR4039		136
U084	SEE U084A		81	U150A	145TDR4355		135	U212	254TDX4014		137	U300	143TFR4040		131
U084A	445TSTGN16531		81	U151	145TDR4075		135	U213	254TDX4017	✓	137	U301	143TFR4034	✓	131
U085	SEE E582A		81	U152	145TDR4117		136	U214	254TDX4008		137	U302	143TFR4046		131
U088	SEE E577		81	U153	145TDR4111	✓	136	U215	254TDX4010		137	U303	143TFR4015		131
U089	SEE E574		80	U154	145TDR4123		136	U216	254TDX4012		137	U304	SEE U304A		131
U090	SEE U090A		81	U155	145TDR4118		136	U217	254TDX4016		137	U304A	143TFR4303	✓	131
U090A	445TTGN16588	✓	81	U156	145TDR4112		136	U218	256TDX4064		137	U305	143TFR4021		131
U091	SEE U091A		81	U157	145TDR4124		136	U219	256TDX4063	✓	137	U306	145TFR4048		131
U091A	449TTGS16585		81	U158	182TDR4142		136	U220	256TDX4328		137	U307	145TFR4045	✓	131
U092	SEE E571		80	U159	SEE U159A		136	U221	256TDX4065		137	U308	145TFR4054		131
U093	SEE E573A		80	U159A	182TTDW4338	✓	136	U223	256TDX4059		137	U309	145TFR4017		131
U094	SEE E576A		81	U160	182TDR4148		136	U224	256TDX4022		137	U310	SEE U310A		131
U095	SEE E850A		81	U161	182TDR4143		136	U225	256TDX4004	✓	137	U310A	145TFR14011	✓	131
U096	SEE E578		81	U162	182TDR4048		136	U226	256TDX4023		137	U311	145TFR4023		131
U097	SEE E594		81	U162A	182TTDW4339		136	U227	284TDP4044		138	U312	145TFR4050		131
U100	256TDX4041		128	U163	182TDR4149		136	U228	SEE U228A		138	U313	SEE U313A		131
U101	256TDX4047		128	U164	182TDR4118		136	U228A	284TDP14044	✓	138	U313A	145TFR14045		131
U102	256TDX4021		128	U165	SEE U165A		136	U229	284TDP4045		138	U314	145TFR4128		131
U103	256TDX4006	✓	128	U165A	182TTDW14011	✓	136	U230	284TDP4011		138	U315	182TFR4015		131
U104	256TDX4019		128	U166	182TDR4124		136	U231	284TDP4022	✓	138	U316	SEE U316A		131
U105	284TDP4043		128	U167	182TDR4119		136	U232	284TDP4012		138	U316A	182TFW4302	✓	131
U106	284TDP4069	✓	128	U168	182TDR4113		136	U233	286TDP4048		138	U317	182TFR4021		131
U107	284TDP4037		128	U169	182TDR4125		136	U234	286TDP4074	✓	138	U319	SEE U319A		131
U108	284TDP4025		128	U170	184TDR4142		136	U235	286TDP4049		138	U319A	182TFW4330	✓	131
U109A	284TDP14009	✓	128	U171	SEE U171A		136	U236	286TDP4020	✓	138	U320	182TFR4056		131

CAT. NO.	MODEL NO.	STOCK	PAGE NO.	CAT. NO.	MODEL NO.	STOCK	PAGE NO.	CAT. NO.	MODEL NO.	STOCK	PAGE NO.	CAT. NO.	MODEL NO.	STOCK	PAGE NO.
U322A	184TTFW4009	✓	131	U426	SEE U426B		38	U513	324TSTDP4007	✓	144	U633	SEE U633A		59
U323	184TTFR4021		131	U426B	182TTDW16049	✓	38	U514	326TSDP4345		144	U633A	254TTF6077	✓	57
U325	SEE U325A		131	U427	184TTDR4153	✓	38	U515	326TSDP4344		144	U634	215TTFW4003		48
U325A	184TTFW4760	✓	131	U427A	184TTDW4153	✓	38	U516	326TSDP4024	✓	144	U636	SEE U636A		58
U326	SEE U326A		131	U428	SEE U428B		38	U517	326TSDP4022	✓	144	U636A	215TTF6002	✓	58
U326A	184TTFW14028		131	U428A	SEE U428B		38	U518	364TSTDS4332	✓	144	U637	215TTF6005		49
U327	213TTFW4009		131	U428B	184TTDW16038	✓	38	U519	364TSTDS4337		144	U637A	215TTF6006	✓	58
U328	213TTFW4011		138	U429	213TTDW4070		38	U520	364TSDS4328		144	U638	254TTFPA4005		49
U329	213TTFW4022	✓	131	U430	SEE U430A		38	U521	326TSDR14034		144	U638A	254TTF6006	✓	58
U330	SEE U372		138	U430A	213TTDW16060	✓	38	U522	364TSDS4025	✓	145	U639	SEE U639A		58
U331	213TTFW4010		131	U430A-P	213TTDW16073	✓	43	U523	364TSTDS4024	✓	145	U639A	215TTF6027	✓	58
U332	213TTFW4012		138	U431A-P	215TTDW16073	✓	43	U524	365TSDS4332	✓	145	U640	215TTFW4030		48
U334	213TTFW4047	✓	131	U432	SEE U432A		41	U525	365TSDS4347		145	U641	215TTF4030		49
U335	213TTFW4038		131	U432A	213TTDW16010		41	U526	365TSDS4025	✓	145	U641A	215TTF6031	✓	58
U336	215TTFW4014		132	U433	SEE U433A		41	U527	365TSDS4303	✓	145	U642	SEE U642A		58
U337	215TTFW4022	✓	132	U433A	215TTDW16061		41	U528	404TSTDS4332	✓	145	U642A	256TTF6077	✓	58
U338	215TTFW4015		132	U435	215TTDW4315		41	U529	404TSTDS4333	✓	145	U643	254TFL14004		48
U339	215TTFW4035		132	U436	SEE U436A		41	U530	404TSDS4017	✓	145	U644	SEE U644		58
U340	215TTFW4047	✓	132	U436A	254TTDN16056	✓	41	U531	404TSDS14008	✓	145	U644A	254TTF6002	✓	58
U341	215TTFW4036		132	U437	254TTDX4315		41	U532	405TSDS4332	✓	145	U645	254TFL14005		48
U343	254TFL4009		138	U438	SEE U438A		41	U533	405TSDS4333		145	U646	SEE U646A		48
U344	254TFL4006	✓	132	U438A	256TTDN16049		41	U534	405TSDS4006	✓	145	U646A	254TFL4027	✓	48
U345	SEE U345A		138	U439	256TTDX4315		41	U535	444TSDS4332	✓	145	U647	SEE U647B		58
U345A	254TFL14008	✓	138	U439A	256TTDN16009		41	U536	444TSDS4010	✓	145	U647B	254TTF6027	✓	58
U346	254TFL4010		132	U440	SEE U440A		41	U537	445TSDS4332	✓	145	U648	254TFL4030		49
U347	254TFL4034		132	U440A	286TSDN16034		41	U538	364TTDS14329		144	U648A	254TTF6031	✓	58
U348	254TFL4031	✓	132	U441	SEE U441A		41	U539	445TSDS14007	✓	145	U649	SEE U649A		58
U349	254TFL4036		132	U441A	286TSDN16005	✓	41	U540	445TSDS14051	✓	145	U649A	256TTF6002	✓	58
U350	256TFL4010		132	U442	SEE U442A		41	U601	145TTN4032		49	U650	256TFL4005		50
U351	256TFL4006	✓	132	U442A	286TSDN16033		41	U602	SEE GT1009		61	U650A	SEE GT1124		62
U352	256TFL4012		132	U443	SEE U443A		41	U602A	SEE GT1009		61	U651	256TFL14027		48
U353	256TFL4036		132	U443A	286TSDN16004	✓	41	U603	SEE E2134		59	U652	SEE U652B		58
U354	256TFL4031	✓	132	U444	SEE U444A		41	U604	182TTF6005		49	U652B	256TTF6027	✓	58
U355	256TFL4038		132	U444A	324TSDP16032		41	U604A	SEE GT1109		61	U653	256TFL4030		50
U356	254TFL4011		138	U445	324TSDP4016	✓	41	U605	SEE U605A		48	U653A	256TTF6031	✓	58
U357	215TTFW14301	✓	132	U445A	324TSDP16002	✓	41	U605A	182TTFW4327	✓	48	U654	284TTFPA4005		50
U360	184TTFW4915	✓	131	U446	SEE U446A		41	U606	145TTN4030		49	U654A	SEE GT1127		62
U363	145TTFR4310	✓	131	U446A	326TSDR16035		41	U607	SEE GT1010		61	U655	284TTFPA4028		50
U366	215TTFW14302		138	U447	SEE U447A		41	U607A	SEE GT1010		61	U659	326TTFPA4030		50
U372	184TTFW4914	✓	138	U447A	326TSDP16005		41	U608	SEE U1608		48	U659A	326TTF6031	✓	59
U400	SEE U400A		44	U448	SEE U448A		41	U609	SEE U609A		59	U660	364TTF6040		50
U400A	445TSDS16038	✓	44	U448A	365TSDS16044		41	U609A	182TTF6031	✓	57	U660A	364TTF6041	✓	59
U401A	145TTDR16308	✓	41	U449	SEE U449A		41	U610	SEE GT1011		61	U661	SEE E314		59
U402	SEE U402C		41	U449A	365TSDS16008		41	U610A	SEE GT1011		61	U662	SEE E316A		60
U402B	SEE U402C		41	U450	SEE U450A		41	U611	184TTFR4003		48	U663	SEE E246		60
U402C	182TTDW16010	✓	41	U450A	365TSDS6074		41	U613	SEE GT1012		61	U667	SEE E326		60
U403	SEE U403A		41	U451	SEE U451A		41	U613A	SEE GT1012		61	U669	SEE U669A		60
U403A	184TTDW16043		41	U451A	365TSDS16005		41	U614	184TTFR4005		48	U669A	445TTFN6028		60
U404	SEE U404B		41	U452	SEE U452A		41	U615	184TTF6005		49	U670	SEE E2121		58
U404B	184TTDW16001	✓	41	U452A	404TSDS6327		41	U615A	184TTF6006	✓	57	U671	213TTF6005		49
U405	SEE U405A		41	U453	SEE U453A		41	U616	184TTFR4038	✓	48	U671A	213TTF6006	✓	57
U405A	213TTDW16063	✓	41	U453A	404TSDS16006	✓	41	U616A	184TTFW4727	✓	48	U672	145TTN4080	✓	49
U410A	182TTDW16059	✓	41	U454A	405TSDS16039		41	U618	SEE U618A		59	U701	SEE GT1201		64
U416	143TTDR4061		36	U455	SEE U455A		41	U618A	184TTF6027	✓	57	U703	145TTFR4046		54
U417	SEE U417A		37	U455A	405TSDS16005		41	U619	SEE U1619		48	U704	SEE GT1204		64
U417A	143TTDR6052	✓	37	U456	SEE U456A		41	U620	184TTF6030		49	U705	145TTFR4052		54
U418	143TTDR4051	✓	37	U456A	444TSDS16034		41	U620A	184TTF6031	✓	57	U706	145TTFR4070		54
U418A	143TTDR6051	✓	37	U500	256TTDX4024		144	U621	SEE U621A		59	U707	SEE GT1207		64
U419	145TTDR4128		37	U501	256TTDX4020		144	U621A	215TTF6077	✓	57	U708	145TTFR4126		54
U420	SEE U420A		37	U502	284TTDP4027		144	U622	213TTFW4003		48	U710	SEE GT1210		64
U420A	145TTDR6126	✓	37	U503	284TTDP4047		144	U624	SEE GT1015		61	U713	SEE GT1213		64
U421	SEE U421A		37	U504	284TSDP4002		144	U624A	SEE GT1015		61	U716	SEE GT1216		65
U421A	145TTDR6127	✓	37	U505	284TSDP14007		144	U625	213TTFW4005		48	U718	215TTFW4033		55
U422	145TTDR4134	✓	37	U506	286TSDP4041		144	U627	213TTFW4028	✓	48	U721	254TFL4033		55
U423	SEE U423A		37	U507	286TTDP14042		144	U629	SEE U629A		59	U722	SEE GT1222		65
U423A	145TTDR6132	✓	37	U508	286TSDP4022	✓	144	U629A	213TTF6027	✓	57	U723	254TFL4035		55
U424	SEE U424A		37	U509	286TSDP4023	✓	144	U630	213TTFW4030		48	U724	SEE GT1225		65
U424A	145TTDR6133	✓	37	U510	324TTDP4038		144	U631	213TTF6030		49	U725	SEE GT1228		65
U425	SEE U1425		38	U511	324TTDP14049		144	U631A	213TTF6031	✓	57	U726	SEE GT1231		65
U425B	182TTDW16048		38	U512	324TSDP4010	✓	144	U632	SEE E2117		59	U727	SEE GT1234		65

# Index

## Catalog Number/Model Number

CAT. NO.	MODEL NO.	STOCK	PAGE NO.	CAT. NO.	MODEL NO.	STOCK	PAGE NO.	CAT. NO.	MODEL NO.	STOCK	PAGE NO.	MODEL NO.	CAT. NO.	STOCK	PAGE NO.
U728	SEE GT1237		65	U872	SEE U872A		66	U946	SEE E500		80	U1927	364TTDCA6086	✓	44
U729	SEE GT1240		65	U872A	256TTFNA16574	✓	66	U947	SEE U063A		80	U1928	365TTDCA6086	✓	44
U730	SEE GT1243		65	U873	SEE U873A		66	U948	SEE U007A		80	W501	143THTN9026	✓	71
U731	SEE GT1246		65	U873A	284TTFNA16832	✓	66	U949	SEE E501		80	W502	143THTN19033		71
U733	143TTFR4010	✓	54	U874	SEE U874A		66	U950	SEE E502		80	W503	145THTN9076		71
U735	SEE GT1206		64	U874A	286TTFNA16572	✓	66	U951	SEE E503		80	W504	182THFS19101		71
U736	182TTFR4013		54	U875	SEE U875A		66	U952	SEE E504		80	W505	143THTN9001		71
U737	SEE GT1209		64	U875A	324TTFS16837	✓	66	U953	SEE E505		80	W506	143THTN9005		71
U738	184TTFR4013		54	U876	SEE U876A		66	U954	SEE E506		80	W507	145THTN9026	✓	71
U739	SEE GT1212		64	U876A	326TTFS16574	✓	66	U955	SEE E507		80	W508	145THTN19045		71
U740	213TTFW4007		55	U877	SEE U877A		66	U956	SEE E546		80	W509	182THTS9076		71
U741	SEE GT1215		64	U877A	364TTFS16558	✓	66	U957	SEE E547		80	W511	145THTN9001		71
U742	213TTFW4008		55	U878	SEE U878A		66	U958	SEE U048A		80	W512	145THTN19002		71
U743	215TTFW4013		55	U878A	365TTFS16827	✓	66	U959	SEE E563		80	W513	145THTN9027	✓	71
U744	SEE GT1218		65	U879	SEE U879A		66	U960	SEE E564		80	W514	145THTN19033		71
U746	SEE GT1221		65	U879A	405TTFS16834	✓	66	U961	SEE E565		80	W515	184THTS9076		71
U748	SEE GT1224		65	U880	SEE U880A		66	U962	SEE E566		80	W517	182THTS9001		72
U749	SEE GT1227		65	U880A	444TTFN16549	✓	66	U963	SEE E567		80	W519	182THTS9026	✓	72
U750	SEE GT1230		65	U881	SEE U881A		66	U964	SEE E568A		80	W520	182THTS19033		72
U757	SEE GT1220		65	U881A	445TTFN16866	✓	66	U965	SEE E569		80	W521	213THFS9076	✓	72
U758	143TDR6027	✓	42	U882	SEE U882A		66	U966	SEE E570		80	W522	215THFS9101		72
U758-P	143TDR16052	✓	42	U882A	445TTFN16852		66	U967	SEE E571		80	W523	184THFS9001	✓	72
U759	145TDR6028	✓	42	U884	445TTFN4575		66	U968	SEE E572		80	W524	184THFS19006		72
U759-P	145TDR16348	✓	42	U900	254TDX4018		38	U969	SEE E573A		80	W525	184THFS9026	✓	72
U760	145TDR6029	✓	42	U901	284TSDP4004	✓	39	U970	SEE E574		80	W526	184THFS9030	✓	72
U760-P	145TDR16349	✓	42	U902	286TSDP4017		39	U971	SEE E575		81	W527	215THFS9076	✓	72
U763	213TDC6026	✓	43	U903	404TTDS4042		39	U972	SEE E576A		81	W528	215THFS19077		72
U764	213TDC6001	✓	43	U903A	404TTDS16055		44	U973	SEE E577		81	W529	254THFNA9101		72
U765	215TDC6026	✓	43	U904	405TDS4049		39	U974	SEE E578		81	W530	213THTS9001	✓	72
U766	215TDC6001	✓	43	U904A	405TDS16060		44	U975	SEE E594		81	W531	213THTS19005		72
U767	254TDC6026	✓	43	U905	145TDR4103		37	U976	SEE E580A		81	W532	213THFS9026	✓	72
U768	254TDC6001	✓	43	U906	145TDR4005		37	U977	SEE U073A		81	W533	213THFS9030	✓	72
U769	256TDC6026	✓	43	U906A	145TDR16008	✓	42	U978	SEE E582A		81	W534	254THFNA9076	✓	72
U770	256TDC6001	✓	43	U907	213TDDW4078	✓	38	U979	SEE E583		81	W536	256THFNA9101		72
U771	284TDC6026	✓	43	U908	182TDR4106		38	U980	SEE E584		81	W537	215THFS9001	✓	72
U772	284TSDC6001	✓	43	U908A	182TDDW16008	✓	43	U981	SEE E585		81	W538	215THFS19006		72
U773	286TDC6026	✓	43	U909	324TSDP4006		38	U982	SEE U090A		81	W539	215THFS9026	✓	72
U774	286TSDC6001	✓	44	U910	326TSDP4003		39	U984	SEE E588		81	W540	215THFS19033	✓	72
U775	324TDC6026	✓	44	U911	444TTDS4069		39	U985	SEE U091A		81	W541	256THFNA9076	✓	72
U755-P	324TDR16050	✓	44	U911A	444TTDS16043		44	U986	SEE U986A		79	W542	256THFNA19081		72
U776	324TSDC6001	✓	44	U912	445TTDS4070		39	U986A	143TTGN6532		79	W543	284THFNA19102		72
U777	326TDC6026	✓	44	U912A	445TTDS16041		44	U987	SEE U987A		79	W544	254THFNA9001	✓	72
U778	326TSDC6001	✓	44	U914	182TTDW16009	✓	42	U987A	145TTGN16532		79	W546	254THFNA9026	✓	72
U785	447TSDN16004	✓	44	U915	184TTDW16076	✓	42	U988	SEE U988A		79	W546-P	254THFNA19065	✓	72
U786	447TSDN16046	✓	44	U917	184TTDW16041		38	U988A	145TTGN6550		79	W547	254THFNA9030		72
U788	447TSDN16007	✓	44	U922	143TDR4055		37	U989	SEE U989A		79	W548	284THFNA9076	✓	72
U789	447TSDN16041		44	U922A	143TDR16036		37	U989A	182TTGN6541		79	W549	284THFNA19084		72
U790	449TSDN16077		44	U923	145TDR4130		37	U990	SEE U990A		79	W550	286THFNA19101	✓	72
U791	447TSDN16008	✓	44	U923A	145TDR16054		37	U990A	184TTGN6544		79	W551	256THFNA9001	✓	72
U793	449TSDN16003	✓	44	U924	145TDR4136		37	U991	SEE U991A		80	W553	256THFNA9026	✓	72
U795	449TSDN16004	✓	44	U924A	145TDR16059		37	U991A	213TTGN6540	✓	80	W553-P	256THFNA19056	✓	72
U797	449TSDN16005	✓	44	U925	182TDR4075		38	U991A-P	213TTGN16548	✓	80	W554	256THFNA19033	✓	72
U798	324TDC6076	✓	43	U925A	182TTDW16082		38	U992	SEE U992A		80	W555	286THFNA9076	✓	72
U799	326TDC6076	✓	43	U926	213TTDW4071		38	U992A	215TTGN6539	✓	80	W556	286THFNA19077		72
U815	SEE GT1224		65	U926A	213TTDW16061		38	U992A-P	215TTGN16539	✓	80	W558	284THFNA9001	✓	72
U830	SEE GT1233		65	U930	SEE U001A		79	U1248	182TTDW6001	✓	43	W559	284THFNA9005		72
U834	SEE GT1236		65	U931	SEE U039A		79	U1266	182TTDW6076	✓	42	W560	284THFNA9026	✓	72
U838	SEE GT1239		65	U933	SEE U002A		79	U1267	184TTDW6076	✓	42	W560-P	284THFNA19048	✓	72
U842	SEE GT1242		65	U934	SEE U040A		79	U1402	SEE U402C		41	W561	284THFNA19033	✓	72
U845	SEE GT1245		65	U935	SEE U059A		79	U1404	SEE U404B		41	W562	324THFS9076	✓	72
U867	SEE U867A		66	U936	SEE U003A		79	U1425	182TTDW4074	✓	38	W563	324THFS9080		72
U867A	182TFN6557		66	U937	SEE U041A		79	U1426	SEE U426B		38	W565	286THFNA9001	✓	72
U868	SEE U868A		66	U938	SEE U060A		79	U1608	182TTFW4040	✓	48	W567	286THFNA9026	✓	72
U868A	184TFN6555	✓	66	U939	SEE U004A		79	U1619	184TTFW4040		48	W567-P	286THFNA19066	✓	72
U869	SEE U869A		66	U940	SEE U042A		79	U1647	SEE U647B		58	W568	286THFNA19033		72
U869A	213TFN6550	✓	66	U941	SEE U061A		79	U1652	SEE U652B		58	W569	326THFS9076	✓	72
U870	SEE U870A		66	U942	SEE U005A		79	U1779	364TTDCA6060	✓	44	W571	324THFS9001	✓	73
U870A	215TFN6546	✓	66	U943	SEE U043A		79	U1782	364TSTDCA6001	✓	44	W573	324THFS9026	✓	73
U871	SEE U871A		66	U944	SEE U062A		80	U1783	365TTDCA6060	✓	44	W573-P	324THFS19058	✓	73
U871A	254TTFNA16568	✓	66	U945	SEE U006A		80	U1784	365TSTDCA6001	✓	44	W574	324THFS19033		73

## Catalog Number/Model Number

CAT. NO.	MODEL NO.	STOCK	PAGE NO.	CAT. NO.	MODEL NO.	STOCK	PAGE NO.	CAT. NO.	MODEL NO.	STOCK	PAGE NO.	CAT. NO.	MODEL NO.	STOCK	PAGE NO.
W575	SEE W575A		73	X001	048A11O1799	✓	162	X081	048A11O2031	✓	156	X420	048A17O169	✓	156
W575A	364THFS19087	✓	73	X002	048A11O1769	✓	162	X082	SEE X083		156	X422	048A17O172	✓	157
W576	365THFS19101		73	X003	048A11O2042	✓	162	X083	048A11O2034	✓	156	X423	048A11O2055	✓	156
W577	326TSHFS9001		73	X004	048A11O1755	✓	162	X085	048A11O678	✓	157	X424	048A11O2054	✓	157
W578	326TSHFS9005		73	X005	048A11O1756	✓	162	X086	048A8O2001	✓	157	X426	048A11O1375	✓	157,173
W579	326TSHFS9036		73	X006	048A11O2001	✓	162	X087	048A11O2029	✓	156	X427	048A11T2017	✓	158
W580	326THFS9026	✓	73	X009	048A11O787	✓	162	X088	048A11O2032	✓	157	X428	SEE X412		158
W580-P	326THFS19071	✓	73	X010	048A11O2046	✓	162	X089	048A11O2035	✓	157	X429	048A11T2020	✓	158
W581	326THFS19033		73	X011	048A17O2005	✓	156,162	X090	048A11O2007	✓	157	X430	048A11T463	✓	158
W582	SEE W582A		73	X012	048A17O2006	✓	156,162	X096	048A11O840	✓	157	X431	048A11O1461	✓	160
W582A	365THFS19086	✓	73	X013	048A17O152	✓	162	X097	048A8O182	✓	156	X432	056A11O29	✓	158
W583	404THFS9101		73	X014	048A17O154	✓	162	X098	048A8O181	✓	157	X433	056A11O30	✓	158
W584	364TSHFS9001	✓	73	X015	048A17O151	✓	162	X099	048A11O2016	✓	157	X440	048A11O2065	✓	157
W586	364TSHFS9026		73	X016	048A17O153	✓	162	X200	048A11O1060	✓	181	X441	048A11O2062	✓	157
W587	364THFS9036	✓	73	X017	048A17O155	✓	162	X203	048A11O1062	✓	177	X442	048A11O2064	✓	157
W587-P	364THFS19061	✓	73	X018	048A11O1350	✓	162	X206	056A11O5310	✓	159	X443	048A11O2063	✓	157
W588	364THFS19033		73	X019	048A11O1351	✓	162	X207	056A11O5311	✓	159	X444	048A11O1596	✓	157
W589	404THFS9086		73	X020	048A11O1352	✓	162	X208	056A8O5	✓	157	X445	048A11O1732		159
W590	405THFS19101		73	X021	048A11O1353	✓	162	X209	048A8O183	✓	162,180	X446	048A11O1643	✓	159
W591	365TSHFS9001	✓	73	X022	048A17O174	✓	162	X210	048A11O1068	✓	177	X447	048A11O1642	✓	159
W592	365TSHFS19002		73	X023	048A11O1583	✓	162	X211	048A17O125	✓	162,178	X448	056A11O5314	✓	159
W593	SEE W593A		73	X024	048A17T2002	✓	101	X212	048A11O1065		181	X449	056A11O5315		159
W593A	365TSHFS19034		73	X025	048A17T2003	✓	101	X213	048A11O1524	✓	156	X450	048A8T71	✓	158
W594	365THFS9036	✓	73	X026	048A17T2004	✓	101	X214	048A11O1525	✓	157	X451	048A8T72	✓	158
W594-P	365THFS19065	✓	73	X027	048A11T2021	✓	101	X215	048A11O1081		181	X452	048A8T73	✓	158
W595	365THFS9044	✓	73	X028	048A11T2022	✓	101	X216	048A11O1097	✓	157,180	X453	048A11O1771	✓	157
W596	405THFS9086		73	X029	048A11T2023	✓	101	X218	056A11O5313	✓	181	X454	048A17O250	✓	157
W597	444THFS9101		73	X030	048A17T118	✓	101	X219	048A11O2047	✓	162	X455	048A11O1770	✓	157
W598	405TSHFS9001	✓	73	X031	048A17T237	✓	101	X221	048A11O1526	✓	157	X456	048A11T578	✓	158
W599	405TSHFS9026		73	X032	048A17T119	✓	101	X222	048A11O1109	✓	177	X457	048A11T579	✓	158
W600	405THFS9036	✓	73	X033	048A11O1674	✓	162,180	X223	048A11O2050	✓	177	X458	048A11T580	✓	158
W600-P	405THFS19327	✓	73	X034	048A11O1773	✓	163	X230	048A17O136	✓	173,178	X459	048A11T581	✓	158
W601	405THFS9040	✓	73	X035	048A11O1774	✓	163	X235	056T11D5209	✓	178	X462	048A11T619	✓	158
W603	445THFN9106		73	X036	048A11O1772	✓	163	X236	048A11O699	✓	162,177,180	X463	048A17T356	✓	158
W604	SEE W604A		73	X037	048A11O1876	✓	162	X237	048A11O694		162,177	X464	048A17T359	✓	158
W604A	444TSHFN19002		73	X038	048A11O1874	✓	163	X241	048A11O697	✓	162,177	X465	048A8T11002	✓	158
W606	444THFS9036	✓	73	X039	048A11O1875	✓	163	X242	048A11O756	✓	162,177	X466	048A17T86	✓	158
W606-P	444THFN19044	✓	73	X040	048A17O69	✓	164	X251	056T34D5364	✓	169,178	X467	048A17T87	✓	158
W607	444THFS9040	✓	73	X041	048A17O70	✓	164	X258	048A11O1167	✓	164	X468	048A17T96	✓	158
W608	445THFN9086		73	X042	048A11O653	✓	164	X259	056T11O15	✓	179	X469	048A11T276	✓	158
W609	445THFN9102		73	X043	048A11O654	✓	164	X260	048A11O251	✓	178	X470	048A11O885	✓	180
W610	445TSHFN9001		73	X044	048A11O655	✓	164	X261	048A8O151	✓	178	X471	048A11O1044	✓	163
W611	445TSHFN9026	✓	73	X045	048A11O656	✓	164	X262	048A11D245	✓	173	X472	048A11O1045	✓	163
W612	445THFN9036	✓	73	X048	048A11O772		164	X263	048A11O11041		173	X473	048A11O1046	✓	163
W612-P	445THFN19071	✓	73	X049	048A11O773	✓	164	X264	048A11O11040		173	X474	048A11O1047	✓	163
W613	445THFN9037		73	X050	048A11O774	✓	164	X268	048A11O1239	✓	173,182	X475	048A17O123	✓	163
W614	445THFN9087		73	X052	048A11O775	✓	164	X269	048A17O147	✓	173,179	X476	048A17O124	✓	163
W615	449THFS9101		73	X056	048A11O901	✓	164	X270	048A17O149	✓	173,181	X477	048A17O128	✓	163
W616	445TSHFN9005		74	X057	048A11O900	✓	164	X271	056A11O5305	✓	159	X500	056T11O5300	✓	161
W617	445TSHFN9028		74	X058	048A17O2001	✓	164	X273	048A17O161		177	X501	056T11O5301	✓	161
W618	445THFN9038		74	X059	048A17O2002		164	X278	048A8O206	✓	157,180	X502	056T11O5302	✓	161
W618-P	445THFN19070	✓	74	X060	048A17O2003		164	X295	048A11O1410		182	X503	056T11O5303	✓	161
W619	449THFS9030		74	X061	048A11O2022	✓	164	X297	048A11T509	✓	157,180	X506	056T8O5301		161
W621	449THFS19092		74	X062	048A11O2009	✓	164	X298	048A11O2059	✓	157	X507	056T8O5302	✓	161,173
W622	449THFS9088		74	X063	048A11O2028	✓	164	X301	048A17T72	✓	174	X509	056T11O5304	✓	161
W624	449TSHFS9003		74	X064	048A11O2011		164	X302	048A11T199	✓	174	X511	056T8O5303	✓	161
W626	449THFS9028		74	X065	048A11O2012	✓	164	X303	048A11T198	✓	174	X512	056T11O15511		160
W626-P	449THFS19342	✓	74	X066	048A11O2013	✓	164	X304	048A11T201	✓	174	X513	056T11O5305	✓	160
W630	449THFS19079		74	X067	048A11O2014	✓	164	X305	048A17T2001	✓	174	X522	056T11O5308	✓	161
W632	449THFS9027		74	X068	048A11O2015		164	X400	048A11O2017	✓	157	X523	056T11O5306	✓	160,173
W634	449TSHFS9001		74	X069	048A17O2004		164	X405	048A11O1744	✓	177	X524	056T11O5307	✓	161
W635	449THFS9036		74	X070	048A11O2024	✓	164	X411	048A11T2008	✓	180	X525	056T11O5310	✓	160,173
W636	444THFN19081		73	X071	048A11O2026	✓	164	X412	048A11T569	✓	158	X526	056T11O5309	✓	161
W638	145THTN19079		71	X072	048A11T646	✓	175	X413	048A11T529	✓	158	X527	056T8O5304	✓	161
W639	364THFS19077		73	X073	048A11O11064	✓	176	X414	048A11T571	✓	158	X528	056T8O5306	✓	160,173
W640	365THFS19077		73	X074	048A11O11042	✓	176	X415	048A11T2012	✓	158	X529	056T8O5311	✓	160,173
W641	445THFN19033		73	X075	048A11O11063	✓	176	X416	048A11T2013	✓	158	X530	056T8O5307	✓	161
W642	445THFN19034	✓	74	X076	048A11T11006	✓	175	X417	048A11O2051	✓	162	X531	056T8O15504	✓	160,173
W643	326THFS19078		72	X077	048A11O11066	✓	176	X418	048A11O2052	✓	162	X532	056T11O11001	✓	160
X000	048A11O1798	✓	162	X080	SEE X081		156	X419	048A11O2053		162	X533	056T11O11002	✓	160

# Index

## Catalog Number/Model Number

CAT. NO.	MODEL NO.	STOCK	PAGE NO.	CAT. NO.	MODEL NO.	STOCK	PAGE NO.	CAT. NO.	MODEL NO.	STOCK	PAGE NO.	MODEL NO.	CAT. NO.	STOCK	PAGE NO.
X600	048C17D2057		179	Y361	056H17T2019		84	Y489	213TTDW7201	✓	185	Y572	326THFS8028	✓	88
X601	056C17D2101	✓	179	Y362	056H17F2017	✓	84	Y490	215TTDW17206		185	Y573	364THFS8036	✓	88
X602	056C17D2102	✓	179	Y363	056H17F2015		84	Y491	215TTDW7201		185	Y574	365THFS8036	✓	88
X603	056C17D5346	✓	179	Y364	056H17F2021	✓	84	Y492	256TTDX7207		185	Y575	405THFS8036	✓	89
X700	SEE 4722		174,181	Y365	056H17F2019	✓	84	Y493	284TDP7202		185	Y576	444THFN8036	✓	89
X701	SEE 4404		174,181	Y366	145THTRS329	✓	84	Y500	056H17T2011	✓	84	Y577	445THFN8036	✓	89
X900	SEE H247		102	Y367	145THTRS5330		84	Y501	056H17T2012	✓	84	Y578	445THFN8040	✓	89
X902	056B17F5324		101	Y368	145THFRS329	✓	84	Y502	056H17T2013	✓	84	Y579	449THFS8036	✓	89
X903	SEE X1903		102	Y369	145THFRS330	✓	84	Y503	056H17T2014	✓	84	Y580	449THFS8037	✓	89
X904	SEE X1904		102	Y370	182THFRS329	✓	85	Y504	056H17T2015	✓	84	Y582	286THFPA8086		88
X905	SEE C1314		102	Y371	182THFRS5330		85	Y505	056H17T2016		84	Y583	324THFPA8086		88
X906	SEE C1315		102	Y372	SEE Y1372		85	Y506	056H17F2011	✓	84	Y584	326THFPA8086		88
X908	SEE C1909		102	Y373	SEE Y373A		85	Y507	056H17F2012		84	Y585	364THFS8391		88
X909	048S17T2004	✓	104	Y373A	184THFW7736		85	Y508	056H17F2013		84	Y586	365THFS8380		88
X910	048S17T366	✓	104	Y374	056H17T2018	✓	84	Y509	254THTNA8058	✓	88	Y587	404THFS8092		88
X911	048S17T365	✓	104	Y375	056H17T2020		84	Y510	256THTNA8038	✓	88	Y588	405THFS8378	✓	88
X912	056B17T5303	✓	101	Y376	056H17F2018	✓	84	Y511	284THFPA8038	✓	88	Y589	444THFN8384	✓	89
X913	056B17T20	✓	101	Y377	056H17F2016		84	Y512	286THFPA8038	✓	88	Y590	145THTN8037	✓	88
X920	048A17T2005	✓	182	Y378	056H17F2022	✓	84	Y513	324THFPA8038	✓	88	Y592	056H17T2001	✓	86
X921	048A17T2006	✓	182	Y379	056H17F2020	✓	84	Y514	326THFPA8038	✓	88	Y595	213THFS8028	✓	88
X922	048A17T2007	✓	182	Y380	184TTF57290		184	Y515	364THFS8046	✓	88	Y596	215THFS8029	✓	88
X923	048A17T2024	✓	182	Y381	213TTF5238		184	Y516	365THFS8046	✓	88	Y597	254THFNA8038	✓	88
X924	048A11T2025	✓	182	Y382	215TTF57290	✓	184	Y517	405THFS8046	✓	89	Y598	256THFNA8038	✓	88
X925	048A11T2026	✓	182	Y383	254TTFNA7210		184	Y518	444THFN8046	✓	89	Y600	056H17E5301	✓	87
X1903	5KH32FNA4995	✓	102	Y384	256TTFNA7250	✓	184	Y519	445THFN8046	✓	89	Y601	056H17E5302	✓	87
X1904	5KH33JNA5005	✓	102	Y385	284TTFNA7240	✓	184	Y520	445THFN8050	✓	89	Y602	056H17E5303	✓	87
Y201	215TTDW7376		188	Y386	286TTFNA7260	✓	184	Y521	056H17F2014		84	Y603	056H17E5304	✓	87
Y202	215TTDW7377	✓	188	Y387	324TTF57290	✓	184	Y522	145THTRS328	✓	84	Y604	056H17E5305	✓	87
Y203	254TTDX7377		188	Y388	326TTF59210	✓	184	Y523	145THFRS326		84	Y605	056H17T2021	✓	84
Y204	256TTDX7391	✓	188	Y389	364TTF59234	✓	184	Y525	143HTN8028	✓	88	Y606	056H17T2022	✓	84
Y209	365TTDS7383		188	Y390	365TTF59230	✓	184	Y526	145HTN8029	✓	88	Y611	145THTR16031	✓	86
Y210	404TTDS7387	✓	188	Y391	405TTF5297		184	Y527	182HTS8028	✓	88	Y612	145THTR16032	✓	86
Y211	405TTDS7697		188	Y392	444TTF57262		184	Y530	SEE Y370		85	Y621	SEE U501		144
Y212	444TTDS8699	✓	188	Y393	286THTNA7026	✓	86	Y531	449THFS8046	✓	89	Y623	SEE U503		144
Y213	445TTDS9477		188	Y394	286THTNA7036	✓	86	Y532	449THFS8047	✓	89	Y624	SEE U504		144
Y215	284TDP7692	✓	188	Y395	284THFPA8086		88	Y533	449THFS8048	✓	89	Y625	SEE U505		144
Y216	286TDP7689	✓	188	Y409	SEE Y409A		185	Y534	056H17T5301	✓	86	Y627	SEE U507		144
Y217	324TDP7687	✓	188	Y409A	182TTDW7211	✓	185	Y535	056H17T5302	✓	86	Y629	SEE U509		144
Y218	326TDP7697	✓	188	Y412	SEE Y412A		185	Y536	143THRS326	✓	86	Y631	SEE U511		144
Y219	505UTDS1584		188	Y412A	184TTDW7215	✓	185	Y537	145THRS376	✓	86	Y633	SEE U513		144
Y220	505UTDS1590		188	Y415	215TTDW7203	✓	185	Y538	145THRS326	✓	86	Y635	SEE U515		144
Y250	---		83	Y418	254TTDX7208	✓	185	Y540	184THTL7776	✓	86	Y637	SEE U517		144
Y251	---		83	Y449	145TTDRS703	✓	185	Y541	182THTL7726	✓	86	Y639	SEE U519		144
Y252	---		83	Y450	145TTDRS704		185	Y542	213THTL7776	✓	86	Y641	SEE U538		144
Y253	---		83	Y451	145TTDRS705	✓	185	Y543	184THTL7726	✓	86	Y643	SEE U523		144
Y254	---		83	Y452	145TTDRS706	✓	185	Y544	215THTL7776	✓	86	Y645	SEE U525		145
Y255	---		83	Y453	SEE Y1453		185	Y545	213THTL7726	✓	86	Y647	SEE U527		145
Y256	---		83	Y454	SEE Y454A		185	Y546	254THTL5776	✓	86	Y649	SEE U529		145
Y257	---		83	Y454A	184TTDW7286	✓	185	Y547	215THTL7726	✓	86	Y651	SEE U531		145
Y258	---		83	Y455	215TTDW7204	✓	185	Y548	256THTL5776	✓	86	Y658	SEE U539		145
Y259	---		83	Y456	254TTDX7278	✓	185	Y549	254THTL5726	✓	86	Y659	SEE U540		145
Y260	---		83	Y457	256TTDX7263		185	Y551	145HTN6046	✓	86	Y663	SEE U521		144
Y261	---		83	Y458	256TTDX7264	✓	185	Y552	256THTNA7026	✓	86	Y900	---		83
Y262	---		83	Y459	284TDP7221	✓	185	Y553	284THTNA7026	✓	86	Y901	---		83
Y263	---		83	Y460	286TDP7217		185	Y555	056H17T5311	✓	86	Y902	---		83
Y270	SEE Y270A		85	Y465	145TTDRS701	✓	185	Y556	056H17T5312	✓	86	Y903	---		83
Y270A	182THFW7730		85	Y466	145TTDRS702	✓	185	Y557	145HTN6060	✓	86	Y904	---		83
Y280	056H17T15526	✓	85	Y467	SEE Y467A		185	Y558	182THTL7736	✓	86	Y905	---		83
Y281	056H17T15528	✓	85	Y467A	182TTDW7411	✓	185	Y559	184THTL7736	✓	86	Y906	---		83
Y282	056H17T15527	✓	85	Y468	SEE Y468A		185	Y560	213THTL7736	✓	86	Y907	---		83
Y283	143THTR15535	✓	85	Y468A	184TTDW7230	✓	185	Y561	215THTL7736	✓	86	Y908	---		83
Y284	145THTR15540	✓	85	Y469	215TTDW7205	✓	185	Y562	254THTL5736	✓	86	Y910	---		83
Y285	145HTN17034	✓	85	Y470	254TTDX7201		185	Y563	256THTNA7036	✓	86	Y911	---		83
Y286	182THTL17041	✓	85	Y471	256TTDX7253		185	Y564	184THTS8028	✓	88	Y912	---		83
Y287	184HTL17038	✓	85	Y472	284TDP7205		185	Y565	213THTS8038	✓	88	Y913	---		83
Y302	SEE Y302A		103	Y473	286TDP7251		185	Y566	215THTS8038	✓	88	Y914	---		83
Y302A	184TTDW7611	✓	103	Y485A	182TTDW7203		185	Y567	284THTNA7036		86	Y915	---		83
Y303	184TTDR7612	✓	103	Y486	SEE Y486A		185	Y569	284THFPA8028	✓	88	Y916	---		83
Y304	215TTDW7301	✓	103	Y486A	184TTDW7287	✓	185	Y570	286THFNA8028	✓	88	Y917	---		83
Y360	056H17T2017	✓	84	Y488	213TTDW7202		185	Y571	324THFPA8028	✓	88	Y918	---		83



## Catalog Number/Model Number

CAT. NO.	MODEL NO.	STOCK	PAGE NO.	CAT. NO.	MODEL NO.	STOCK	PAGE NO.	CAT. NO.	MODEL NO.	STOCK	PAGE NO.	CAT. NO.	MODEL NO.	STOCK	PAGE NO.
Y920	---		83	Y1603	---		146	Y1820	---		147	Z401	143TCDR5328		124
Y921	---		83	Y1604	---		146	Y1821	---		147	Z403	145TCDR5328		124
Y922	---		83	Y1605	---		146	Y1822	---		147	Z404	145TBDR5304		124
Y923	---		83	Y1606	---		146	Y1823	---		147	Z405	SEE Z405A		124
Y924	---		83	Y1607	---		146	Y1824	---		147	Z405A	182TCDW7074	✓	124
Y925	---		83	Y1608	---		146	Y1825	---		147	Z406	SEE Z406A		124
Y926	---		83	Y1609	---		146	Y1826	---		147	Z406A	182TCDW7318	✓	124
Y927	---		83	Y1610	---		146	Y1827	---		147	Z407	SEE Z407A		124
Y928	---		83	Y1611	---		146	Y1828	---		147	Z407A	184TCDW7047	✓	124
Y929	---		83	Y1612	---		146	Y1829	---		147	Z408	SEE Z408A		124
Y930	---		83	Y1613	---		146	Y1830	---		147	Z408A	184TBDW17007	✓	124
Y931	---		83	Y1614	---		147	Y1831	---		147	Z409	213TCDW7027	✓	124
Y932	---		83	Y1615	---		147	Y1832	---		147	Z410	213TCDW7002	✓	124
Y933	---		83	Y1616	---		147	Y1833	---		147	Z411	215TBDW7029	✓	124
Y934	---		83	Y1617	---		147	Y1834	---		147	Z412	215TCDW7002	✓	124
Y935	---		83	Y1618	---		147	Y1835	---		147	Z413	215TBDW7027	✓	124
Y936	---		83	Y1619	---		147	Y1836	---		148	Z420	143TCDR5330		132
Y937	---		83	Y1620	---		147	Y1837	---		148	Z422	145TCDR5329		132
Y938	---		83	Y1621	---		147	Y1838	---		148	Z424	182TCDR7354		132
Y939	---		83	Y1622	---		147	Y1839	---		148	Z425	182TCDR8005		132
Y940	---		83	Y1623	---		147	Y1840	---		148	Z426	184TCDR7626		132
Y941	---		83	Y1624	---		147	Y1841	---		148	Z427	SEE Z427A		132
Y942	---		83	Y1625	---		147	Y1842	---		148	Z427A	184TBDW17011	✓	132
Y943	---		83	Y1626	---		147	Y1843	---		148	Z428	213TCDW7028		132
Y944	---		83	Y1627	---		147	Y1844	---		148	Z429	213TCDW7003	✓	132
Y945	---		83	Y1628	---		147	Y1845	---		148	Z430	215TBDW7045		132
Y946	---		83	Y1629	---		147	Y1846	---		148	Z431	215TCDW7004	✓	132
Y947	---		83	Y1630	---		147	Y1847	---		148	Z432	215TBDW7030		132
Y948	---		83	Y1631	---		147	Y1848	---		148	Z433	184TBF7315	✓	124
Y949	---		83	Y1632	---		147	Y1849	---		148	Z433A	184TBF7315	✓	124
Y950	---		83	Y1633	---		147	Y1850	---		148	Z434	213TBF7010	✓	124
Y951	---		83	Y1634	---		147	Y1851	---		148	Z435	215TBF7010	✓	124
Y952	---		83	Y1635	---		147	Y1852	---		148	Z502	184TBDR5326	✓	183
Y953	---		83	Y1636	---		148	Y1999	182THFW729	✓	85	Z504	184TBDR5301		183
Y954	---		83	Y1637	---		148	Z112	SEE Z112A		100	Z506A	184TBDW7656		183
Y955	---		83	Y1638	---		148	Z112A	182TCFW9061	✓	100	Z602	056E17F1001	✓	92
Y956	---		83	Y1639	---		148	Z113	SEE Z113A		100	Z603	056E17F1002	✓	92
Y957	---		83	Y1640	---		148	Z113A	184TCFW9057	✓	100	Z604	056E17F1003	✓	92
Y958	---		83	Y1641	---		148	Z114	SEE Z114A		100	Z605	056E17F1004	✓	92
Y978	143THEN8034		89	Y1642	---		148	Z114A	184TBF7070	✓	100	Z606	056E17F1005	✓	92
Y979	145THEN8034	✓	89	Y1643	---		148	Z115	215TBF7028	✓	100	Z607	056E17F1006	✓	92
Y980	182THES8048	✓	89	Y1644	---		148	Z116	215TBF7044	✓	100	Z610	056E17F1007	✓	92
Y981	213THES8053	✓	89	Y1645	---		148	Z117	213TBF7027	✓	100	Z611	056E17F1008	✓	92
Y982	254THEN8058	✓	89	Y1646	---		148	Z118	145TBFR5328	✓	99	Z612	056E17F2005	✓	92
Y983	254THEN8059	✓	89	Y1647	---		148	Z119	SEE Z119A		99	Z613	056E17F2006	✓	92
Y984	256THEN17031	✓	89	Y1648	---		148	Z119A	182TCFW7072	✓	99	Z614	056E17F2007	✓	92
Y985	284THEN8032	✓	89	Y1649	---		148	Z120	SEE Z120A		99	Z615	145TEFR5326	✓	92
Y986	143THTN8036	✓	90	Y1650	---		148	Z120A	184TBF717045	✓	99	Z616	145TEFR5327	✓	92
Y987	145THTN8043	✓	90	Y1651	---		148	Z121	SEE Z121A		99	Z617	182TEFR5326	✓	92
Y988	182THTS8048	✓	90	Y1652	---		148	Z121A	184TBF7737	✓	99	Z630	056E17V2001	✓	93
Y989	184THTS8056	✓	90	Y1800	---		146	Z122	215TBF7029	✓	99	Z631	056E17V2002		93
Y990	213THTS8071	✓	90	Y1801	---		146	Z123	143TCFR5328	✓	99	Z634	056E17V2003	✓	93
Y991	215THTS8071	✓	90	Y1802	---		146	Z124	SEE Z124A		156	Z635	056E17V2004	✓	93
Y992	254THTNA8071	✓	90	Y1803	---		146	Z124A	184TBDW7369		156	Z636	056E17V2005	✓	93
Y993	256THTNA8071	✓	90	Y1804	---		146	Z125	215TBDR7361		156	Z637	056E17V2006		93
Y994	213THFW7726	✓	85	Y1805	---		146	Z126	215TBDW7362		156	Z638	056E17W2001	✓	93
Y995	213THFW7736		85	Y1806	---		146	Z127	256TBDX7028		156	Z639	056E17W2002	✓	93
Y996	215THFW7726	✓	85	Y1807	---		146	Z128	145TBFR5341	✓	99	Z641	056E17W2003		93
Y997	215THFW7736		85	Y1808	---		146	Z304	145TBDR5309	✓	103	Z660	056E17T2001	✓	93
Y998A	SEE Y1999		85	Y1809	---		146	Z305	SEE Z305A		103	Z662	056E17T2002	✓	93
Y999	SEE Y1999		85	Y1810	---		146	Z305A	184TCDW7615	✓	103	Z663	056E17T2003	✓	93
Y1270	182THFW7730	✓	85	Y1811	---		146	Z306	SEE Z306A		103	Z664	056E17T2004	✓	93
Y1303	184TTDW7612	✓	103	Y1812	---		146	Z306A	184TCDW7617	✓	103	Z665	056E17T2005	✓	93
Y1372	184THFW7726	✓	85	Y1813	---		146	Z307	SEE Z307A		103	Z666	056E17F2008	✓	93
Y1453	182TTDW7413	✓	185	Y1814	---		147	Z307A	184TBDW7009	✓	103	Z667	056E17F2009	✓	93
Y1484	182TTDW7412	✓	185	Y1815	---		147	Z308	215TCDW7003	✓	103	Z668	056E17F2010	✓	93
Y1487	184TTDW7209	✓	185	Y1816	---		147	Z309	182TCDR7013		103	Z669	056E17F2011	✓	93
Y1600	---		146	Y1817	---		147	Z314	215TCDW7012		103				
Y1601	---		146	Y1818	---		147	Z313	184TBDR7324		103				
Y1602	---		146	Y1819	---		147	Z315	215TBDW7013		103				

# Index

## Model Number/Catalog Number

MODEL NO.	CAT. NO.	STOCK	PAGE NO.	MODEL NO.	CAT. NO.	STOCK	PAGE NO.	MODEL NO.	CAT. NO.	STOCK	PAGE NO.	MODEL NO.	CAT. NO.	STOCK	PAGE NO.
003062.09	A960A	✓	215	5K46KN2175	K166	✓	48	5K49PN2330	KG236	✓	123	5KC35JN7X	G1115	✓	24,167
5K32GN30	K151	✓	47	5K46KN4031	K1308	✓	41	5K49PN2348	KG235	✓	51	5KC35JNA489	CG383	✓	186
5K32GN48	K281	✓	168	5K46KN4071	K1119	✓	36	5K49PN3052	K280	✓	169	5KC35JNA489Y	CG384	✓	186
5K32GN53	K418	✓	47	5K46KN4085	K277	✓	169	5K49PN3053	K279	✓	169	5KC35MN145	C1405	✓	32
5K32GNB249X	K717	✓	76	5K46KN4085X	K1410	✓	169	5K49PN4088X	K1415	✓	169	5KC35MN43	G1330	✓	29
5K33FN30	K153	✓	47	5K46KN4125	K250	✓	40	5K49PN4113	K198	✓	47	5KC35MN43X	G1331	✓	29
5K33GN45	K275	✓	169	5K46KN4141	K555	✓	122	5K49PN4120	K521	✓	40	5KC35MN73	G1513	✓	31
5K33JNA943	K253	✓	51	5K46LN6033S	K378	✓	161	5K49PN4121	K751	✓	122	5KC36GN2507X	C1168	✓	120
5K33KN52	K283	✓	168	5K46LN6428S	K1505	✓	161	5K49PN4564	K458	✓	97	5KC36JN266	G1098	✓	21
5K33KN67	K522	✓	51	5K46MN4072	K122	✓	36	5K49PN4565	K460	✓	97	5KC36JN268X	C330	✓	121,172
5K33KN92	K194	✓	47	5K46MN4087	K278	✓	169	5K49PN6019	K1300	✓	40	5KC36JN269X	C331	✓	121
5K35FN101	K748	✓	122	5K46MN4087X	K1412	✓	169	5K49PN6025	K1317	✓	51	5KC35JN8X	C145	✓	21
5K35FN2	K113	✓	36	5K46MN4126	K251	✓	40	5K49PN6164	K1490	✓	51	5KC36LN1	C215	✓	24
5K35FN55	KG215	✓	40,122,172	5K46MN4144	K750	✓	122	5K49PN8030	K1318	✓	51	5KC36LN144	C1420	✓	32
5K35JN198	K527	✓	36	5K46MN4623	K635	✓	41	5K49QN4609	K640	✓	52	5KC36LN144X	C444	✓	32
5K35JN47	K230	✓	123	5K46MN6018	K1299	✓	40	5K49RN4570	K1494	✓	97	5KC36LN166X	C349	✓	31
5K35MN294	K282	✓	168	5K46PN6082	K162	✓	47	5K49RN4617	K646	✓	41	5KC36LN18	C431	✓	21
5K35MN75	K321	✓	47	5K48TN2181	K227	✓	122	5K49RN4621X	K610	✓	66	5KC36LN19X	C460	✓	24
5K35MN8114	K254	✓	51	5K48TN2182	K226	✓	40,122,172	5K49RN6034S	K379	✓	161	5KC36LN1X	C216	✓	24,167
5K35MN8117	K158	✓	47	5K48TN6119S	K1486	✓	160,173	5K49RN6118S	K1485	✓	160	5KC36LN26	C209	✓	24
5K36JN2	K115	✓	36	5K48TN6430S	K1515	✓	161	5K49RN6429S	K1510	✓	161	5KC36LN26X	C210	✓	24
5K36JN56	K217	✓	122	5K48UN3056	K520	✓	169	5K46MN8423	K634	✓	40	5KC36LN30	C153	✓	21
5K36JN57	K216	✓	40,122,172	5K48UN3057	K549	✓	169	5K49RN8424	K622	✓	40	5KC36LN30X	C154	✓	21
5K36MN339	KG232	✓	123	5K48WN3013S	K1482	✓	161,158	5K49SN2184	K238	✓	123	5KC36LN4003Y	C664	✓	29
5K36MN4152	K633	✓	51	5K48WN3181S	K1511	✓	161,158	5K49SN2187	KG237	✓	51	5KC36LN7	C158	✓	21
5K36PN251	G1340	✓	47	5K49DN4130	K252	✓	51	5K49SN3054	K518	✓	169	5KC36LN7X	C159	✓	21
5K36PN254	K523	✓	51	5K49DN4131	K439	✓	47	5K49SN3055	K519	✓	169	5KC36LN83	C355	✓	27
5K36PN30	K155	✓	47	5K49DN4132	K247	✓	40	5K49SN4117	K257	✓	51	5KC36LN83X	C356	✓	27
5K36PN345S	K1403	✓	161	5K49FN2045	K1306	✓	41	5K49SN4118	K167	✓	48	5KC36LN84X	CG683	✓	121
5K36PNB111	K161	✓	47	5K49FN4129	K196	✓	47	5K49SN4119	K260	✓	54	5KC36MN20	CG393	✓	23
5K36PNB116	K255	✓	51	5K49FN4136	K154	✓	47	5K49SN8050	K408	✓	37	5KC36MN2508X	C1169	✓	120
5K37MN252X	K1409	✓	169	5K49FN4138	K248	✓	40	5K49TN4622X	K609	✓	66	5KC36MN27X	C133	✓	26
5K37MN3543	K1483	✓	122	5K49FN6381X	K2101	✓	76	5K49TN6383X	K2110	✓	76	5KC36PNB169X	C646	✓	34
5K37MN37	K218	✓	40,122,172	5K49HN6385X	K2104	✓	76	5K49UN4086X	K1418	✓	169	5KC37EN3900U	4788	✓	171
5K37MN38	KG219	✓	122	5K49JN4051T	K1476	✓	104	5K49UN4566	K461	✓	97	5KC37FN65X	C329	✓	121
5K37NN30	K160	✓	47	5K49JN4560X	K2103	✓	76	5K49UN4567	K462	✓	97	5KC37FN71X	J1025	✓	121,172
5K38PN258X	K1411	✓	169	5K49JN4574X	K2105	✓	76	5K49UN4569	K459	✓	97	5KC37HN3898U	4781	✓	171
5K38PN47	K220	✓	40,122,172	5K49JN4576X	K2112	✓	77	5K49UN6085	K165	✓	47	5KC37LN502Y	C1474	✓	21
5K38PN48	K221	✓	122	5K49JN4582X	K2102	✓	76	5K49UN8052	KG319	✓	191	5KC37LN91	CG111	✓	23
5K38RN106	K500	✓	53	5K49KN2150X	K1413	✓	169	5K49WN4335X	K1497	✓	169	5KC37MN96	C459	✓	21
5K38RN30	K163	✓	47	5K49KN4124	K258	✓	53	5K49ZN2190	K240	✓	123	5KC37NN115X	C847	✓	121
5K38RN49	KG234	✓	123	5K49KN4142	K286	✓	168	5K49ZN4252	K1492	✓	48	5KC37NN14T	C457	✓	24
5K38SN267S	K1404	✓	161	5K49KN4563	K457	✓	97	5K49ZN4253	K1491	✓	51	5KC37NN15	C164	✓	21
5K39SNB505S	K1402	✓	161	5K49KN4573	K456	✓	97	5K49ZN4611	K644	✓	40	5KC37NN160	C449	✓	23
5K39SNB587S	K1407	✓	161	5K49MN4104	K256	✓	51	5K49ZN4616	K648	✓	41	5KC37NN3544T	C1467	✓	155
5K39SNB765T	K1405	✓	161	5K49MN4105	K164	✓	47	5K49ZN6433S	K1520	✓	161	5KC37NN501Y	C1475	✓	21
5K42FN4033	K1305	✓	41	5K49MN4110	K259	✓	53	5KC32GN13	C247	✓	168	5KC37RN35	CG260	✓	29
5K42FN4035	K1322	✓	53	5K49MN4111	K424	✓	47	5KC32GN19	G1312	✓	29	5KC38NN410X	C1155	✓	24,167
5K42GN4619X	K606	✓	66	5K49MN4112	K524	✓	51	5KC32GN19X	CG251	✓	29	5KC38NN413X	C1154	✓	24,167
5K42HN4032	K1307	✓	41	5K49MN4114	K525	✓	168	5KC32GN25	G1511	✓	31	5KC38PN2509X	C1170	✓	120
5K42HN4034	K1324	✓	53	5K49MN4618X	K608	✓	66	5KC32GN9	C242	✓	29	5KC38RN4153Y	C702	✓	21
5K42HN4089	K381	✓	169	5K49MN4620X	K607	✓	66	5KC32GN9X	C243	✓	29	5KC38RN60	C179	✓	21
5K42HN4089X	K1408	✓	169	5K49MN6020	K1316	✓	51	5KC33FN31	C1419	✓	31	5KC38RN60X	C180	✓	21
5K42HN4106	K116	✓	36	5K49MN6079	K159	✓	47	5KC33FN4180X	C1336	✓	121	5KC38SN2510X	C1171	✓	120
5K42HN4109	K197	✓	47	5K49MN6080	K285	✓	168	5KC33KN19	C462	✓	29	5KC39EN2500X	C1087	✓	120
5K42HN4127	K249	✓	40	5K49MN6081	K541	✓	168	5KC33MN2502X	C1089	✓	120	5KC39EN2553X	C1081	✓	120
5K42HN4128	K284	✓	168	5K49MN6126T	K1487	✓	174	5KC33MN2555X	C1083	✓	120	5KC39HN2501X	C1088	✓	120
5K42HN4133	K550	✓	123	5K49MN6369	K526	✓	97	5KC33MN2889X	C1463	✓	120	5KC39HN2554X	C1082	✓	120
5K42HN4134	K426	✓	47	5K49MN6382X	K2116	✓	76	5KC35FN51X	C208	✓	24	5KC39HN2888X	C1462	✓	120
5K42HN4137	K469	✓	51	5K49MN6432S	K1500	✓	161	5KC35GNA488	CG382	✓	186	5KC39NN50X	C332	✓	121,172
5K42HN4139	K553	✓	122	5K49MN8349X	K2107	✓	76	5KC35JN10	C147	✓	21	5KC39QN3218X	C465	✓	121
5K42JN3050	K546	✓	169	5K49NN2046	K1311	✓	41	5KC35JN10X	C148	✓	21	5KC39QN3219X	C333	✓	121
5K42JN3051	K544	✓	169	5K49NN2147X	K1416	✓	169	5KC35JN12	C200	✓	24	5KC39QN3220X	C1152	✓	24,167
5K42JN4163	K318	✓	36	5K49NN2178	K225	✓	122	5KC35JN12X	CG201	✓	24	5KC39RN114T	CG732	✓	121
5K46HN2546	K690	✓	41	5K49NN2180	K224	✓	40,122,172	5KC35JN23X	C129	✓	26	5KC39RN383X	C1157	✓	24,167
5K46KN2082	K1484	✓	122	5K49NN4052T	K1438	✓	104	5KC35JN27Y	CG105	✓	23	5KC39RN44X	C334	✓	121,172
5K46KN2172	K223	✓	122	5K49NN4580X	K2111	✓	76	5KC35JN7	G1114	✓	24,167	5KC39RN45X	C335	✓	121
5K46KN2173	K222	✓	40,122,172	5K49NN4581X	K2115	✓	77	5KC35JN70X	C354	✓	27	5KC39SN2810X	C1084	✓	120

## Model Number/Catalog Number

MODEL NO.	CAT. NO.	STOCK	PAGE NO.	MODEL NO.	CAT. NO.	STOCK	PAGE NO.	MODEL NO.	CAT. NO.	STOCK	PAGE NO.	MODEL NO.	CAT. NO.	STOCK	PAGE NO.
5KC39SN2812X	C1090	✓	120	5KC49PN0155	C235	✓	24,167	5KCP49ZN9617T	P190	✓	157	5KCR49SN0493S	C1315	✓	102
5KC39SN2890X	C1464	✓	120	5KC49PN0155X	CG236	✓	24	5KCR39SN2504X	C1091	✓	120	5KCR49SN3009X	C475	✓	25,167
5KC42GN0014	C261	✓	29	5KC49PN0161	C181	✓	21	5KCR39SN2557X	C1085	✓	120	5KCR49SN3009X	C1478	✓	25,167
5KC42GN0014X	C262	✓	29	5KC49PN0161U	C1480	✓	21,183,189	5KCR39SN2891X	C1465	✓	120	5KCR49SN3010	C476	✓	25,167
5KC42GN0018	G1515	✓	31	5KC49PN0161X	C182	✓	21	5KCR39UN2505X	C1092	✓	120	5KCR49TN2139U	G1392	✓	30
5KC42GN0018X	C446	✓	31	5KC49PN0162	C188	✓	21	5KCR39UN2511X	C1172	✓	120	5KCR49TN2155T	C466	✓	31
5KC42GN0066	C375	✓	32	5KC49PN0163X	CG363	✓	27	5KCR39UN2512X	C1173	✓	120	5KCR49TN2164T	C878	✓	121
5KC42GN00309X	C289	✓	168	5KC49PN0164X	C1158	✓	24,167	5KCR39UN2558X	C1086	✓	120	5KCR49TN8058T	C1274	✓	155
5KC46GN0050Y	F12E1	✓	99	5KC49PN0253	C1469	✓	186	5KCR39UN2892X	C1466	✓	120	5KCR49UN0079U	C1294	✓	100
5KC46GN0075U	C1291	✓	100	5KC49PN0281X	C806	✓	168	5KCR46JN0083X	E252	✓	28	5KCR49UN0106X	EG284	✓	32
5KC46GN0251	C1458	✓	186	5KC49PN0283	C1425	✓	32	5KCR46JN0083Y	E250	✓	28	5KCR49UN0106Y	EG282	✓	32
5KC46GN0251Y	C1459	✓	186	5KC49PN2144Y	C1477	✓	22	5KCR46JN0084	E251	✓	27	5KCR49UN0107	EG283	✓	31
5KC46GN0569Y	C661	✓	29	5KC49PN2521Y	C704	✓	22,183	5KCR46JN0085	E253	✓	21	5KCR49UN0108	E285	✓	30
5KC46JN0002X	C138	✓	24	5KC49PN3027X	C419	✓	25,167	5KCR46JN0086X	E254	✓	24	5KCR49WN02070	C193	✓	22
5KC46JN0076U	C1292	✓	100	5KC49PN3036	C248	✓	29	5KCR46JN0087X	E257	✓	32	5KCR49WN02070T	CG381	✓	22
5KC46LN0149X	C1156	✓	24,167	5KC49PN6051	C1258	✓	24	5KCR46JN0087Y	E255	✓	32	5KCR49WN0295U	C1295	✓	100
5KC46LN0153	C175	✓	21	5KC49PN6051X	C548	✓	24	5KCR46JN0088	E256	✓	31	5KCR49WN6075	C178	✓	21
5KC46LN0153U	C177	✓	21	5KC49PN6062	C1333	✓	29	5KCR46JN0089	E258	✓	29	5KCR49WN6077	CG232	✓	24
5KC46LN0153X	C176	✓	21	5KC49PN6070	C1252	✓	21	5KCR46MN0054X	E263	✓	24	5KCR49WN6078	C1412	✓	32
5KC46LN0158	CG230	✓	24,167	5KC49QN0716X	C1807	✓	34	5KCR46MN0055X	E266	✓	32	5KCR49WN7855	C1909	✓	102
5KC46LN0158X	D1113	✓	24,167	5KC49QN0718X	C1816	✓	35	5KCR46MN0055Y	E264	✓	32	5KCR49ZN2722Y	9038	✓	23,183
5KC46LN0159	CG361	✓	27	5KC49QN4559X	C1810	✓	34	5KCR46MN0090X	E261	✓	28	5KCR49ZN8061T	C1275	✓	155
5KC46LN0159X	CG362	✓	27	5KC49RN2152T	C1159	✓	25,167	5KCR46MN0090Y	E259	✓	28	5KE48WN4593	K2066	✓	107
5KC46LN0252	C1460	✓	186	5KC49RN2520Y	C703	✓	22	5KCR46MN0091	E260	✓	27	5KE48WN8364	K2056	✓	107
5KC46LN0252Y	C1461	✓	186	5KC49SN2156X	C855	✓	31	5KCR46MN0092	E262	✓	21	5KE48WN8365	K2033	✓	51
5KC46LN0254X	C1483	✓	26	5KC49SN2158	C1424	✓	31	5KCR46MN0093	E265	✓	31	5KE49PN4594	K2069	✓	36
5KC46LN0269X	4686	✓	167	5KC49SN2418U	C662	✓	30	5KCR46MN0094	E267	✓	29	5KE49PN8391	K2021	✓	41
5KC46NN0758Y	C1298	✓	21	5KC49SN2537Y	C1269	✓	28	5KCR46NN0264T	C1303	✓	102	5KE49PN8418	K2018	✓	40
5KC46PN0015	C268	✓	29	5KC49SN6375X	C1809	✓	34	5KCR48TN2142T	C340	✓	121,172	5KE49TN4592	K2068	✓	107
5KC46PN0015X	C269	✓	29	5KC49SN6380X	C1817	✓	35	5KCR48TN2174T	C341	✓	121	5KE49TN4597	K2067	✓	108
5KC46PN0032	G1517	✓	31	5KC49SN8060T	C1273	✓	155	5KCR48TN2650Y	9035	✓	23,183	5KE49QN8375T	K2038	✓	169
5KC46PN0359Y	C1489	✓	186	5KC49TN0033	C295	✓	30	5KCR48TN3084X	C1479	✓	25,167	5KE49UN8376T	K2037	✓	169
5KC48TN2169	C187	✓	22	5KC49TN0034	C275	✓	30	5KCR48TN8062	C194	✓	22	5KE49TN8378	K2055	✓	107
5KC48UN6052	C1264	✓	24	5KC49TN0034X	C276	✓	30	5KCR48UN0102Y	EG277	✓	28	5KE49TN8384T	K2030	✓	169
5KC48UN6052X	C552	✓	24	5KC49TN0035	G1519	✓	31	5KCR48UN0104	E280	✓	21	5KE49TN8401	K2022	✓	41
5KC48UN6072	C1422	✓	27	5KC49TN0063Y	F10E1	✓	99	5KCR48UN0105X	E281	✓	24	5KE49UN8407	K2023	✓	41
5KC48UN6073	C1263	✓	21	5KC49TN0067	C376	✓	32	5KCR48UN2653Y	9036	✓	22,183	5KE49UN8428	K2043	✓	40
5KC49GN0001	B1316	✓	24,167	5KC49TN0285X	C292	✓	168	5KCR48UN2654Y	9040	✓	183	5KE49WN4571	K2045	✓	97
5KC49GN0001X	CG223	✓	24	5KC49TN0568Y	C660	✓	30	5KCR48WN0273	G1376	✓	30	5KE49WN4572	K2046	✓	97
5KC49GN0009X	C359	✓	27	5KC49TN2141X	C338	✓	121,172	5KCR48WN0273X	G1377	✓	30	5KH140DFK1X	H950	✓	119
5KC49GN0010	C167	✓	21	5KC49TN2170X	C339	✓	121	5KCR48WN0292	C297	✓	30	5KH140DFK17X	H951	✓	119
5KC49GN0010X	C168	✓	21	5KC49UN6065	C264	✓	29	5KCR48WN0292Y	F15E1	✓	99	5KH32DN111	H208	✓	170
5KC49GN0010Y	C169	✓	21,183	5KC49UN6067	C1404	✓	31	5KCR48WN0294	G1531	✓	31	5KH32DN3085	HG156	✓	165
5KC49GN0022X	C1153	✓	24,167	5KC49ZN2539Y	C1270	✓	28	5KCR48WN0566Y	C659	✓	30	5KH32DN3085X	H157	✓	165
5KC49HN0719X	C1803	✓	34	5KCP33GNA471S	P239	✓	104	5KCR48WN0756Y	C1299	✓	22,183	5KH32DN5587X	4725	✓	119
5KC49HN2509X	C1814	✓	35	5KCP35CNA490S	PG240	✓	174	5KCR48WN6066	C271	✓	29	5KH32DN5597X	HG679	✓	119
5KC49LN6386X	H891	✓	34	5KCP35KNB057S	P250	✓	102	5KCR49PN0077U	C1293	✓	100	5KH32DN5618X	HG701	✓	165
5KC49MN2043Y	9031	✓	21,183	5KCP35KNB650U	P254	✓	186	5KCR49PN0095X	E270	✓	28	5KH32DNA612	H901	✓	22
5KC49MN2049Y	9032	✓	21,183,189	5KCP35NNA670T	P247	✓	186	5KCR49PN0095Y	E268	✓	28	5KH32DNA612X	H902	✓	22
5KC49MN6061	G1316	✓	29	5KCP36NNB059S	P251	✓	102	5KCR49PN0096	E269	✓	27	5KH32DNA700	H912	✓	165
5KC49MN6063	C1423	✓	31	5KCP36NNB670U	PG252	✓	186	5KCR49PN0097	EG271	✓	21	5KH32DNA700X	H913	✓	165
5KC49MN6379X	C1818	✓	35	5KCP36NNB671U	P253	✓	186	5KCR49PN0098X	EG272	✓	24	5KH32EN124	H244	✓	31
5KC49MN6384X	C1801	✓	34	5KCP36RNA491S	P241	✓	174	5KCR49PN0099X	E275	✓	32	5KH32EN66	H116	✓	29
5KC49NN0061T	4688	✓	167	5KCP39SNB480S	P193	✓	159	5KCR49PN0099Y	EG273	✓	32	5KH32EN72X	H291	✓	168
5KC49NN0221X	9029	✓	23	5KCP39SNB481S	P194	✓	159	5KCR49PN100	E274	✓	31	5KH32EN79	HG178	✓	168
5KC49NN0222X	9030	✓	189	5KCP39SNB482S	P195	✓	159	5KCR49PN101	EG276	✓	29	5KH32EN5015U	4785	✓	171
5KC49NN0224X	C1187	✓	24	5KCP39TNB763T	P196	✓	159	5KCR49PN0492S	C1314	✓	102	5KH32ENA443X	H682	✓	119
5KC49NN2044Y	9034	✓	23	5KCP39UNB764T	P198	✓	159	5KCR49PN3011	C420	✓	25,167	5KH32ENB168X	H454	✓	34
5KC49NN2050Y	9033	✓	21,183	5KCP39UNB767T	P197	✓	159	5KCR49PN3011X	C474	✓	25,167	5KH32FN3083	H160	✓	165
5KC49NN2081T	C1468	✓	155	5KCP49PN9812S	P245	✓	159	5KCR49PN3012X	C486	✓	25,167	5KH32FN3083X	HG161	✓	165
5KC49NN2130X	C273	✓	30	5KCP49RN9611S	P243	✓	159	5KCR49QN6076	C183	✓	21	5KH32FN3120T	4680	✓	165
5KC49NN2130Y	C274	✓	30	5KCP49UN9613S	P244	✓	159	5KCR49RN2148T	C1161	✓	25,167	5KH32FN3122	H134	✓	102
5KC49NN2132X	C445	✓	32	5KCP49UN9612S	P184	✓	159	5KCR49SN0012X	CG239	✓	25	5KH32FN3122S	H135	✓	102
5KC49NN2133X	C351	✓	31	5KCP49UN9614S	P185	✓	159	5KCR49SN0042S	C1302	✓	102	5KH32FN3123	HG120	✓	29
5KC49NN2135X	C352	✓	121	5KCP49UN9811S	P246	✓	159	5KCR49SN0065	C191	✓	22	5KH32FN3123X	HG121	✓	29
5KC49NN2140X	C336	✓	121,172	5KCP49UN9837S	F780	✓	104	5KCR49SN0068	C185	✓	22	5KH32FN5586X	4406	✓	119
5KC49NN2167X	C337	✓	121	5KCP49UN9838S	F781	✓	101	5KCR49SN0068X	C186	✓	22	5KH32FN5598X	HG680	✓	119
5KC49NN2419Y	C663	✓	30	5KCP49WN9813S	P180	✓	159	5KCR49SN0150X	C1160	✓	25,167	5KH32FNA499S	X1903	✓	102

# Index

## Model Number/Catalog Number

MODEL NO.	CAT. NO.	STOCK	PAGE NO.	MODEL NO.	CAT. NO.	STOCK	PAGE NO.	MODEL NO.	CAT. NO.	STOCK	PAGE NO.	MODEL NO.	CAT. NO.	STOCK	PAGE NO.
5KH32FNA611	H903	✓	22	5KH36MN3106X	H248	✓	166	5KH39QN9538	4354	✓	21	5KH49SN3023X	H288	✓	170
5KH32FNA611X	H904	✓	22	5KH36MN3127T	4684	✓	166	5KH39QN9541T	4338	✓	166	5KH49SN3046	H296	✓	165
5KH32GN42	H195	✓	102	5KH36MNA445X	H684	✓	119	5KH39QN9542	4351	✓	23	5KH49SN3048	H300	✓	165
5KH32GN42S	HG196	✓	102	5KH36MNA735X	H919	✓	166	5KH39QN9543	4373	✓	23	5KH49SN3049	H224	✓	170
5KH32GN140X	HG152	✓	165	5KH36MNB637X	H926	✓	119	5KH39QN9544X	4393	✓	166	5KH49UN3024X	H280	✓	170
5KH32GN142	H204	✓	170	5KH36NN37	HG140	✓	102	5KH39QN9546	4372	✓	23	5KH49UN6064	HG188	✓	168
5KH32GN68X	H243	✓	29	5KH36NN37S	HG141	✓	102	5KH39QN9547	4376	✓	23	5KHC37NNA167T	HG700	✓	166
5KH32GNB811X	4805	✓	119	5KH36NNB166X	HG455	✓	34	5KH39QN9548	4322	✓	165	5KHC39QN9575T	H649	✓	102
5KH32GNB812X	HG450	✓	119	5KH36PN106	H203	✓	102	5KH39QN9548X	4389	✓	165	5KHC39QN9581T	HG648	✓	102
5KH32GNB813X	H451	✓	119	5KH36PN108	HG189	✓	168	5KH39QN9550X	4412	✓	165	5KHC39QN9584X	H647	✓	102
5KH32GNB814X	HG681	✓	119	5KH36PN109	H233	✓	168	5KH39QN9551X	4399	✓	165	5KS46MN4078	E34D4	✓	36
5KH32GNB815X	H712	✓	119	5KH36PNB171X	HG458	✓	34	5KH39QN9631T	H131	✓	166	5KS49HN4077	E12D4	✓	36
5KH32HN5620T	HG711	✓	166	5KH37GNA782X	HG717	✓	174	5KH39QN9632	H130	✓	166	5KS49HN4595	E286	✓	106
5KH32HNA532T	4734	✓	170	5KH37NNA768	H907	✓	22	5KH39QN9636T	4757	✓	166	5KS49UN4598	EG311	✓	108
5KH32JN3128	H164	✓	166	5KH37NNA768X	H908	✓	22	5KH39QN9639T	4778	✓	26	048A11D245	X262	✓	173
5KH32JN3128X	H165	✓	166	5KH37PN33	H171	✓	165	5KH39QN9642T	H133	✓	166	048A11O1044	X471	✓	163
5KH33FN6	H239	✓	21	5KH37PN33X	H172	✓	165	5KH39QN9681X	4380	✓	23	048A11O1045	X472	✓	163
5KH33FN77	H212	✓	170	5KH37PN36	H209	✓	170	5KH39QN9682	4370	✓	166	048A11O1046	X473	✓	163
5KH33FN77X	H213	✓	170	5KH37PN36X	H210	✓	170	5KH39QN9683	4396	✓	165	048A11O1047	X474	✓	163
5KH33FN85	HG123	✓	29	5KH37PN37	H205	✓	170	5KH39QN9684	4387	✓	26	048A11O1060	X200	✓	181
5KH33FN85X	HG124	✓	29	5KH37PN37X	H278	✓	170	5KH39QN9686X	4362	✓	21	048A11O1062	X203	✓	177
5KH33FNA230	H675	✓	25	5KH37PN39	H112	✓	165	5KH39QN9687	4422	✓	26	048A11O1065	X212	✓	181
5KH33FNA722X	H915	✓	165	5KH37PN39X	HG113	✓	165	5KH39QN9696X	4731	✓	170	048A11O1068	X210	✓	177
5KH33GN5014U	4774	✓	171	5KH37PN40	H223	✓	170	5KH39QN9697T	4759	✓	166	048A11O1081	X215	✓	181
5KH33GNA444X	H683	✓	119	5KH37PN41	H158	✓	165	5KH39QN9698T	4758	✓	166	048A11O1097	X216	✓	157,180
5KH33HN5725X	4702	✓	165	5KH37PN41X	H159	✓	165	5KH39QN9702T	4732	✓	170	048A11O11040	X264	✓	173
5KH33JN3121	HG138	✓	102	5KH37PNA233	HG695	✓	165	5KH39QN9703T	4738	✓	170	048A11O11041	X263	✓	173
5KH33JN3121S	H139	✓	102	5KH37PNA479X	HG714	✓	119	5KH39QN9704T	4739	✓	170	048A11O11042	X074	✓	176
5KH33JNA500S	X1904	✓	102	5KH37PNA569T	HG706	✓	166	5KH39QN9725T	4730	✓	170	048A11O11063	X075	✓	176
5KH33JNA511T	HG710	✓	26	5KH38SNA731T	HG715	✓	166	5KH39QN9767X	HG694	✓	166	048A11O11064	X073	✓	176
5KH33JNA534T	4735	✓	170	5KH39CN5501X	H641	✓	119	5KH39QNA039	4390	✓	166	048A11O11066	X077	✓	176
5KH33KN20S	H277	✓	102	5KH39CN5504X	H642	✓	119	5KH39QN9810	H645	✓	25	048A11O1109	X222	✓	177
5KH33KN5594	H673	✓	26	5KH39DNA533T	4733	✓	170	5KH42GN0336	B1507	✓	168	048A11O1167	X258	✓	164
5KH33FN124	H114	✓	165	5KH39EN2506X	H440	✓	120	5KH42GN0337	HG143	✓	102	048A11O1239	X268	✓	173,182
5KH33FN124X	HG115	✓	165	5KH39EN2552X	H439	✓	120	5KH42JN0328	H276	✓	102	048A11O1350	X018	✓	162
5KH33FN153T	4798	✓	165	5KH39EN2887X	H685	✓	120	5KH42JN0328S	H247	✓	102	048A11O1351	X019	✓	162
5KH33GNA229	H676	✓	23	5KH39QN5508	4369	✓	26	5KH46JN0329X	H693	✓	26	048A11O1352	X020	✓	162
5KH33HN9	H229	✓	23	5KH39QN5508X	4310	✓	26	5KH46MN3021X	HG155	✓	165	048A11O1353	X021	✓	162
5KH33JN26	H166	✓	166	5KH39QN5511X	4305	✓	165	5KH46MN3025	H173	✓	166	048A11O1375	X426	✓	157,173
5KH33JN26X	H167	✓	166	5KH39QN5512T	4701	✓	165	5KH46MN3025X	H174	✓	166	048A11O1410	X295	✓	182
5KH33JN121	H217	✓	170	5KH39QN5514T	4706	✓	166	5KH46MN3040	H225	✓	170	048A11O1461	X431	✓	160
5KH33JN121X	H218	✓	170	5KH39QN5520X	4314	✓	165	5KH46MN3041	H207	✓	170	048A11O1524	X213	✓	156
5KH33JN132T	4682	✓	166	5KH39QN5523	4359	✓	25	5KH46MN6053	H162	✓	165	048A11O1525	X214	✓	157
5KH33JN602X	HG690	✓	25	5KH39QN5524	4377	✓	26	5KH46MN6053X	H163	✓	165	048A11O1526	X221	✓	157
5KH33JN603X	H689	✓	23	5KH39QN5526X	4363	✓	165	5KH46MN6071	H214	✓	170	048A11O1583	X023	✓	162
5KH33JNA231	H674	✓	26	5KH39QN5528X	4381	✓	26	5KH46MN6071X	H215	✓	170	048A11O1596	X444	✓	157
5KH33JNA723X	H917	✓	166	5KH39QN5529	4371	✓	26	5KH46N3039T	HG705	✓	166	048A11O1642	X447	✓	159
5KH33LNB164X	HG456	✓	34	5KH39QN5529X	4311	✓	26	5KH46PN3033	HG191	✓	168	048A11O1643	X446	✓	159
5KH33MN132	H197	✓	102	5KH39QN5537X	4306	✓	165	5KH46PN3034	H293	✓	168	048A11O1674	X033	✓	162,180
5KH33MN132S	H198	✓	102	5KH39QN5538X	4350	✓	165	5KH46PN6059	HG186	✓	168	048A11O1732	X445	✓	159
5KH33MN56	B1504	✓	168	5KH39QN5539T	4776	✓	26	5KH48UN6054X	H298	✓	166	048A11O1744	X405	✓	177
5KH33MN56X	H236	✓	168	5KH39QN5541X	4364	✓	25	5KH48UN6074	H221	✓	170	048A11O1755	X004	✓	162
5KH33MNA519T	HG703	✓	166	5KH39QN5543	4304	✓	165	5KH49MN3035	H190	✓	168	048A11O1756	X005	✓	162
5KH33MNA568T	HG704	✓	165	5KH39QN5548	4360	✓	165	5KH49MN6057	H136	✓	102	048A11O1769	X002	✓	162
5KH36DNA780X	HG716	✓	174	5KH39QN5550X	4404	✓	174,181	5KH49MN6057S	H137	✓	102	048A11O1770	X455	✓	157
5KH36JNA769	H905	✓	22	5KH39QN5558T	4722	✓	174,181	5KH49MN6060	HG182	✓	168	048A11O1771	X453	✓	157
5KH36JNA769X	H906	✓	22	5KH39QN9091	H230	✓	23	5KH49PN3026	H175	✓	166	048A11O1772	X036	✓	163
5KH36KN112	H206	✓	170	5KH39QN9105	B1502	✓	168	5KH49PN3026X	H176	✓	166	048A11O1773	X034	✓	163
5KH36KN112X	H287	✓	170	5KH39QN9105X	H234	✓	168	5KH49PN3042	H226	✓	170	048A11O1774	X035	✓	163
5KH36KN113X	HG154	✓	165	5KH39QN9397	4368	✓	23	5KH49PN3042X	H282	✓	170	048A11O1798	X000	✓	162
5KH36KN114	H169	✓	165	5KH39QN9401T	4708	✓	166	5KH49PN3043	H620	✓	165	048A11O1799	X001	✓	162
5KH36KN114X	H170	✓	165	5KH39QN9405X	4392	✓	166	5KH49PN3045	H275	✓	166	048A11O1874	X038	✓	163
5KH36KNB633X	H344	✓	119	5KH39QN9429T	4319	✓	165	5KH49PN3047	H222	✓	170	048A11O1875	X039	✓	163
5KH36LN488X	H691	✓	23	5KH39QN9508Y	HG646	✓	100	5KH49PN6055	H168	✓	166	048A11O1876	X037	✓	162
5KH36LN489X	HG692	✓	26	5KH39QN9513X	4383	✓	166	5KH49PN6055X	HG621	✓	166	048A11O2001	X006	✓	162
5KH36LN4504	H696	✓	23	5KH39QN9514X	4309	✓	166	5KH49PN6056	HG142	✓	102	048A11O2007	X090	✓	157
5KH36MN137	H290	✓	170	5KH39QN9518X	4602	✓	26	5KH49PN6056S	HG699	✓	102	048A11O2009	X062	✓	164
5KH36MN3106	H286	✓	166	5KH39QN9537X	4349	✓	21	5KH49PN6069	H219	✓	170	048A11O2011	X064	✓	164

## Model Number/Catalog Number

MODEL NO.	CAT. NO.	STOCK	PAGE NO.	MODEL NO.	CAT. NO.	STOCK	PAGE NO.	MODEL NO.	CAT. NO.	STOCK	PAGE NO.	MODEL NO.	CAT. NO.	STOCK	PAGE NO.
048A11O2012	X065	✓	164	048A11T2021	X027	✓	101	048C17D2044	B315	✓	167	056A11O30	X433	✓	158
048A11O2013	X066	✓	164	048A11T2022	X028	✓	101	048C17D2045	S118	✓	25	056A11O5305	X271	✓	159
048A11O2014	X067	✓	164	048A11T2023	X029	✓	101	048C17D2046	S119	✓	25	056A11O5310	X206	✓	159
048A11O2015	X068	✓	164	048A11T2024	X923	✓	182	048C17D2055	D119	✓	167	056A11O5311	X207	✓	159
048A11O2016	X099	✓	157	048A11T2025	X924	✓	182	048C17D2057	X600	✓	179	056A11O5313	X218	✓	181
048A11O2017	X400	✓	157	048A11T2026	X925	✓	182	048C17F11005	F1201	✓	100	056A11O5314	X448	✓	159
048A11O2022	X061	✓	164	048A11T11006	X076	✓	175	048C17F11006	F1202	✓	100	056A11O5315	X449	✓	159
048A11O2024	X070	✓	164	048A17O69	X040	✓	164	048C17F11007	F1203	✓	100	056A8O5	X208	✓	157
048A11O2026	X071	✓	164	048A17O70	X041	✓	164	048C34D2024	O010	✓	171	056B11F5302	G579	✓	33
048A11O2028	X063	✓	164	048A17O123	X475	✓	163	048C34D2025	G091	✓	21	056B11F5303	G578	✓	33
048A11O2029	X087	✓	156	048A17O124	X476	✓	163	048C34D2028	O011	✓	171	056B11G5301	G655	✓	34
048A11O2031	X081	✓	156	048A17O125	X211	✓	162,178	048C34S204	O012	✓	171	056B17D56	K016	✓	183,189
048A11O2032	X088	✓	157	048A17O128	X477	✓	163	048C34S2001	O013	✓	171	056B17D67	B353	✓	167
048A11O2034	X083	✓	156	048A17O136	X230	✓	173,178	048N17D14	B703	✓	166	056B17D2010	G919	✓	21
048A11O2035	X089	✓	157	048A17O147	X269	✓	173,179	048S17D997	B400	✓	155	056B17D2011	G250	✓	27
048A11O2046	X010	✓	162	048A17O149	X270	✓	173,181	048S17D2017	D107	✓	165	056B17D2012	G156	✓	24,167
048A11O2047	X219	✓	162	048A17O151	X015	✓	162	048S17D2042	S102	✓	25	056B17D2013	B609	✓	167
048A11O2050	X223	✓	177	048A17O152	X013	✓	162	048S17D2052	B300	✓	165	056B17D5303	G274	✓	27
048A11O2051	X417	✓	162	048A17O153	X016	✓	162	048S17D2053	B322	✓	165	056B17D5319	G979	✓	189
048A11O2052	X418	✓	162	048A17O154	X014	✓	162	048S17D2054	B302	✓	165	056B17D5322	K232	✓	189
048A11O2053	X419	✓	162	048A17O155	X017	✓	162	048S17D2055	B303	✓	165	056B17D5323	G958	✓	189
048A11O2054	X424	✓	157	048A17O161	X273	✓	177	048S17D2056	B304	✓	166	056B17D5328	G290	✓	189
048A11O2055	X423	✓	156	048A17O169	X420	✓	156	048S17D2057	B305	✓	166	056B17D5331	B352	✓	25,167
048A11O2059	X298	✓	157	048A17O172	X422	✓	157	048S17D2058	B306	✓	166	056B17D5701	B332	✓	167
048A11O2062	X441	✓	157	048A17O174	X022	✓	162	048S17D2059	B307	✓	166	056B17D5703	B335	✓	167
048A11O2063	X443	✓	157	048A17O250	X454	✓	157	048S17D2086	D143	✓	166	056B17F5302	G378	✓	30,190
048A11O2064	X442	✓	157	048A17O2001	X058	✓	164	048S17D2087	D162	✓	166	056B17F5305	G574	✓	33
048A11O2065	X440	✓	157	048A17O2002	X059	✓	164	048S17D2088	D163	✓	166	056B17F5306	G575	✓	33
048A11O251	X260	✓	178	048A17O2003	X060	✓	164	048S17D2089	S003	✓	23	056B17F5307	F105	✓	99
048A11O653	X042	✓	164	048A17O2004	X069	✓	164	048S17D2090	S006	✓	23	056B17F5310	G396	✓	190
048A11O654	X043	✓	164	048A17O2005	X011	✓	156,162	048S17D2091	S103	✓	25	056B17F5319	K319	✓	32,101,190
048A11O655	X044	✓	164	048A17O2006	X012	✓	156,162	048S17D2093	S106	✓	26	056B17F5324	X902	✓	101
048A11O656	X045	✓	164	048A17T72	X301	✓	174	048S17D2104	S126	✓	25	056B17F5328	T018	✓	191
048A11O678	X085	✓	157	048A17T86	X466	✓	158	048S17D2105	S127	✓	26	056B17F5329	T030	✓	191
048A11O694	X237	✓	162,177	048A17T87	X467	✓	158	048S17D2106	S128	✓	26	056B17F5330	D404	✓	97
048A11O697	X241	✓	162,177	048A17T96	X468	✓	158	048S17D2107	B206	✓	165	056B17F5331	F205	✓	100
048A11O699	X236	✓	162,177,180	048A17T118	X030	✓	101	048S17D2108	B207	✓	166	056B17F5584	F135	✓	32,99
048A11O756	X242	✓	162,177	048A17T119	X032	✓	101	048S17D2109	B208	✓	166	056B17F15516	F1205	✓	100
048A11O772	X048	✓	164	048A17T237	X031	✓	101	048S17D2113	S026	✓	23	056B17T20	X913	✓	101
048A11O773	X049	✓	164	048A17T356	X463	✓	158	048S17D2116	B606	✓	165	056B17T5303	X912	✓	101
048A11O774	X050	✓	164	048A17T359	X464	✓	158	048S17D2117	B607	✓	166	056B17V5301	N272	✓	113
048A11O775	X052	✓	164	048A17T2001	X305	✓	174	048S17D7204	D180	✓	165	056B17V5302	N273	✓	113
048A11O787	X009	✓	162	048A17T2002	X024	✓	101	048S17D7205	D181	✓	166	056B17V5303	N283	✓	113
048A11O840	X096	✓	157	048A17T2003	X025	✓	101	048S17D7209	B402	✓	155	056B17V5304	N285	✓	113
048A11O885	X470	✓	180	048A17T2004	X026	✓	101	048S17S24	O003	✓	171	056B34D2018	K212	✓	189
048A11O900	X057	✓	164	048A17T2005	X920	✓	182	048S17S25	O002	✓	171	056B34D2021	G987	✓	189
048A11O901	X056	✓	164	048A17T2006	X921	✓	182	048S17T286	O600	✓	171	056B34D2023	G258	✓	27
048A11O2042	X003	✓	162	048A17T2007	X922	✓	182	048S17T290	O601	✓	171	056B34D2026	G937	✓	22
048A11T198	X303	✓	174	048A34SU1001	O701	✓	171	048S17T365	X911	✓	104	056B34D2027	D115	✓	25,167
048A11T199	X302	✓	174	048A8O151	X261	✓	178	048S17T366	X910	✓	104	056B34D2028	O231	✓	172
048A11T201	X304	✓	174	048A8O181	X098	✓	157	048S17T2004	X909	✓	104	056B34D2029	D010	✓	21,183,189
048A11T276	X469	✓	158	048A8O182	X097	✓	156	048S34S361	O100	✓	171	056B34D2031	G254	✓	27
048A11T463	X430	✓	158	048A8O183	X209	✓	162,180	048S34S2003	O004	✓	171	056B34D2033	J058	✓	121
048A11T509	X297	✓	157,180	048A8O206	X278	✓	157,180	048S34S2004	O005	✓	171	056B34D5302	D017	✓	22,183
048A11T529	X413	✓	158	048A8O2001	X086	✓	157	048S34S2005	O102	✓	171	056B34D5304	G976	✓	189
048A11T569	X412	✓	158	048A8T71	X450	✓	158	048T17D2000	G044	✓	36	056B34D5307	G294	✓	189
048A11T571	X414	✓	158	048A8T72	X451	✓	158	048T17V2001	N460	✓	114	056B34D5319	G272	✓	27
048A11T578	X456	✓	158	048A8T73	X452	✓	158	048T17V2002	N461	✓	114	056B34D5320	K152	✓	25
048A11T579	X457	✓	158	048A8T11002	X465	✓	158	048T17V11001	N701	✓	118	056B34D5334	G996	✓	189
048A11T580	X458	✓	158	048C17D2023	S010	✓	23	048T17V11002	N704	✓	118	056B34D5336	K219	✓	189
048A11T581	X459	✓	158	048C17D2024	S011	✓	23	52A101229AAG1	A549	✓	214	056B34D5337	O232	✓	172
048A11T619	X462	✓	158	048C17D2027	S030	✓	23	52A103486G1	A964	✓	215	056B34D5341	J059	✓	121
048A11T646	X072	✓	175	048C17D2028	S110	✓	26	52D310814AAP1	A942	✓	215	056B34F5303	K332	✓	190
048A11T2008	X411	✓	180	048C17D2029	S111	✓	26	52D310822ACP1	A962	✓	215	056B34F5306	K612	✓	190
048A11T2012	X415	✓	158	048C17D2034	G078	✓	21	52D310833AAP001	A940	✓	215	056B34F5312	K615	✓	190
048A11T2013	X416	✓	158	048C17D2041	B312	✓	167	52D311808ARP1	A941	✓	215	056B34F5318	K618	✓	190
048A11T2017	X427	✓	158	048C17D2042	B313	✓	167	52D311819ABP1	A963	✓	215	056B34F5319	G533	✓	31
048A11T2020	X429	✓	158	048C17D2043	B314	✓	167	056A11O29	X432	✓	158	056B34F5320	G374	✓	30

# Index

## Model Number/Catalog Number

MODEL NO.	CAT. NO.	STOCK	PAGE NO.	MODEL NO.	CAT. NO.	STOCK	PAGE NO.	MODEL NO.	CAT. NO.	STOCK	PAGE NO.	MODEL NO.	CAT. NO.	STOCK	PAGE NO.
056B34F5321	G391	✓	30	056C17F5327	F104	✓	99	056C34F5310	G359	✓	30	056H17F2018	Y376	✓	84
056B34F5322	K350		30	056C17F5349	T016	✓	191	056C34F5311	G390	✓	30,190	056H17F2019	Y365	✓	84
056B34F5324	K631		32	056C17F5350	T014	✓	191	056C34F5322	G514		31	056H17F2020	Y379	✓	84
056B34F5326	D314	✓	33	056C17F5351	T010	✓	191	056C34F5323	G516	✓	31	056H17F2021	Y364	✓	84
056B34F5327	D315	✓	33	056C17F5352	D400	✓	97	056C34F5324	G518	✓	31	056H17F2022	Y378	✓	84
056B34F5328	D316	✓	33	056C17F5353	D401	✓	97	056C34F5327	K339		29	056H17T2001	Y592	✓	86
056B34F5332	T017	✓	191	056C17F5354	D402	✓	97	056C34F5339	T015	✓	191	056H17T2011	Y500	✓	84
056B34F5333	T019	✓	191	056C17F5355	D403	✓	97	056C34F5340	T013	✓	191	056H17T2012	Y501	✓	84
056B34W5301	N286	✓	113	056C17F5357	F204	✓	100	056C34G5308	G653	✓	34	056H17T2013	Y502	✓	84
056C11D5304	G278	✓	27,170	056C17F5358	F131	✓	32,99	056C34G5309	G656		34	056H17T2014	Y503	✓	84
056C11F5302	G577	✓	33	056C17F5912	F132	✓	32,99	056C34G5310	G658		34	056H17T2015	Y504	✓	84
056C11F5303	G576	✓	33	056C17F5913	F133	✓	32,99	056C34G5311	G854		35	056H17T2016	Y505	✓	84
056C11G5303	K033	✓	34	056C17F5914	F134	✓	32,99	056C34G5314	G873	✓	35	056H17T2017	Y360	✓	84
056C11G5306	G650	✓	34	056C17F5955	G381	✓	190	056C34G5315	G875	✓	35	056H17T2018	Y374	✓	84
056C11G5307	G652	✓	34	056C17F5956	G382	✓	190	056C34G5316	G858		35	056H17T2019	Y361	✓	84
056C17D2010	G095	✓	21	056C17F5957	G380		190	056C34V5301	N284	✓	113	056H17T2020	Y375	✓	84
056C17D2025	G151	✓	24,167	056C17G5308	K037		34	056C34V5302	N281	✓	113	056H17T2021	Y605	✓	84
056C17D2044	G234	✓	27	056C17G5315	G651	✓	34	056C34W5301	N530	✓	105	056H17T2022	Y606	✓	84
056C17D2051	S013	✓	23	056C17G5316	G654	✓	34	056C34W5302	N532	✓	105	056H17T5301	Y534	✓	86
056C17D2054	S014	✓	23	056C17G5317	G657	✓	34	056C34W5303	N524	✓	105	056H17T5302	Y535	✓	86
056C17D2055	S015	✓	23	056C17G5318	G659	✓	34	056C34W5304	N526	✓	105	056H17T5311	Y555	✓	86
056C17D2060	S114	✓	26	056C17G5320	G853	✓	35	056C34W5305	N528	✓	105	056H17T5312	Y556	✓	86
056C17D2061	S115	✓	26	056C17G5321	G855	✓	35	056C34W5307	N558	✓	105	056H17T15526	Y280	✓	85
056C17D2064	S033	✓	23	056C17G5322	G857	✓	35	056C34W5308	N540	✓	105	056H17T15527	Y282	✓	85
056C17D2067	S036	✓	23	056C17G5323	G870	✓	35	056C34W5309	N542	✓	105	056H17T15528	Y281	✓	85
056C17D2072	B317	✓	24,167	056C17G5324	G871	✓	35	056C34W5310	N544	✓	105	056PNRA10100	SY001	✓	91
056C17D2073	B318	✓	24,167	056C17G5326	G874	✓	35	056C34W99003	N546	✓	105	056PNRA10101	SY003	✓	91
056C17D2074	B319	✓	24,167	056C17G5327	G876	✓	35	056E17F1001	Z602	✓	92	056PNRA10102	SY004	✓	91
056C17D2079	D111	✓	24,167	056C17G5328	G872	✓	35	056E17F1002	Z603	✓	92	056PNRA10103	SY005	✓	91
056C17D2084	G212	✓	27	056C17V5301	N282	✓	113	056E17F1003	Z604	✓	92	056S17D2023	S120	✓	26
056C17D2085	G230	✓	27	056C17V5302	N271	✓	113	056E17F1004	Z605	✓	92	056S17D2046	S022	✓	23
056C17D2088	G135	✓	24,167	056C17V5303	N280	✓	113	056E17F1005	Z606	✓	92	056S17D2047	B201	✓	165
056C17D2097	S112	✓	26	056C17V5304	N270	✓	113	056E17F1006	Z607	✓	92	056S17D2048	B202	✓	166
056C17D2098	S012	✓	23	056C17W5326	N531	✓	105	056E17F1007	Z610	✓	92	056S17D2049	B200	✓	166
056C17D2099	S113	✓	26	056C17W5327	N523	✓	105	056E17F1008	Z611	✓	92	056S17D2050	D149	✓	166
056C17D2101	X601	✓	179	056C17W5328	N525	✓	105	056E17F2005	Z612	✓	92	056S17D2062	B401	✓	155
056C17D2102	X602	✓	179	056C17W5329	N527	✓	105	056E17F2006	Z613	✓	92	056S17D2064	B100	✓	166
056C17D2113	B608	✓	167	056C17W5330	N529	✓	105	056E17F2007	Z614	✓	92	056S17D2066	S027	✓	23
056C17D2114	K234		28	056C17W5331	N557	✓	105	056E17F2008	Z666	✓	93	056S17F5303	B506	✓	168
056C17D2115	K235	✓	28	056C17W5332	N559	✓	105	056E17F2009	Z667	✓	93	056S34D93	O201	✓	172
056C17D5308	G951	✓	22,183	056C17W5333	N541	✓	105	056E17F2010	Z668	✓	93	056S34D2000	O200	✓	172
056C17D5310	G256	✓	27	056C17W5334	N543	✓	105	056E17F2011	Z669	✓	93	056T11D5209	X235	✓	178
056C17D5311	G270	✓	27	056C17W5335	N545	✓	105	056E17T2001	Z660	✓	93	056T11D5301	G061	✓	36
056C17D5319	S037	✓	23	056C17W5336	N680	✓	105	056E17T2002	Z662	✓	93	056T11D5302	G067	✓	36
056C17D5320	S039	✓	23	056C17W5337	N681	✓	105	056E17T2003	Z663	✓	93	056T11D5303	G088	✓	36
056C17D5339	S116	✓	26	056C17W5338	N682	✓	105	056E17T2004	Z664	✓	93	056T11D5304	K007	✓	37
056C17D5340	S117	✓	26	056C34D2098	O212	✓	172	056E17T2005	Z665	✓	93	056T11F5307	K701	✓	53
056C17D5343	S038	✓	23	056C34D2099	O213	✓	172	056E17V2001	Z630	✓	93	056T11F5308	G589	✓	53
056C17D5346	X603	✓	179	056C34D2100	G915	✓	21	056E17V2002	Z631	✓	93	056T11F5309	G588	✓	53
056C17D5347	B336	✓	25,167	056C34D2101	G238	✓	27	056E17V2003	Z634	✓	93	056T11F5310	G587	✓	53
056C17D5348	B337	✓	167	056C34D2104	O214	✓	172	056E17V2004	Z635	✓	93	056T11F5311	G586	✓	53
056C17D5349	B338	✓	167	056C34D2105	O217	✓	172	056E17V2005	Z636	✓	93	056T11F5320	K404	✓	51
056C17E5302	K032		34	056C34D2106	D118	✓	24,167	056E17V2006	Z637		93	056T11F5321	K407	✓	51
056C17E5314	G639	✓	34	056C34D2108	G232	✓	27	056E17W2001	Z638	✓	93	056T11F5325	D451	✓	98
056C17E5319	G852	✓	35	056C34D2109	O211	✓	172	056E17W2002	Z639	✓	93	056T11F5326	D453	✓	98
056C17F15537	F1204	✓	100	056C34D2112	O215	✓	172	056E17W2003	Z641		93	056T11F5327	D455	✓	98
056C17F2049	G332	✓	29	056C34D2114	O210	✓	172	056H17E5301	Y600	✓	87	056T11F5328	K700	✓	54
056C17F2051	G339	✓	29	056C34D2117	G216	✓	27	056H17E5302	Y601	✓	87	056T11O15	X259	✓	179
056C17F2052	G314	✓	29	056C34D2118	J054	✓	121	056H17E5303	Y602	✓	87	056T11O5300	X500	✓	161
056C17F5308	G356	✓	29	056C34D2119	J055	✓	121	056H17E5304	Y603	✓	87	056T11O5301	X501	✓	161
056C17F5311	G373	✓	30,190	056C34D2120	J056	✓	121	056H17E5305	Y604	✓	87	056T11O5302	X502	✓	161
056C17F5320	G570	✓	33	056C34D2121	J057	✓	121	056H17F2011	Y506	✓	84	056T11O5303	X503	✓	161
056C17F5321	G571	✓	33	056C34F5301	D311	✓	33	056H17F2012	Y507		84	056T11O5304	X509	✓	161
056C17F5322	G572	✓	33	056C34F5302	D312	✓	33	056H17F2013	Y508		84	056T11O5305	X513	✓	160
056C17F5323	G573	✓	33	056C34F5303	D313	✓	33	056H17F2014	Y521		84	056T11O5306	X523	✓	160,173
056C17F5324	F101	✓	99	056C34F5307	G393	✓	29	056H17F2015	Y363		84	056T11O5307	X524	✓	161
056C17F5325	F102	✓	99	056C34F5308	G352	✓	29	056H17F2016	Y377		84	056T11O5308	X522	✓	161
056C17F5326	F103	✓	99	056C34F5309	G379	✓	29,190	056H17F2017	Y362	✓	84	056T11O5309	X526	✓	161

## Model Number/Catalog Number

MODEL NO.	CAT. NO.	STOCK	PAGE NO.	MODEL NO.	CAT. NO.	STOCK	PAGE NO.	MODEL NO.	CAT. NO.	STOCK	PAGE NO.	MODEL NO.	CAT. NO.	STOCK	PAGE NO.
056T11O5310	X525	✓	160,173	056T17E5314	G664	✓	76	056T17V99006	N351	✓	109	056T34F5305	D395	✓	54
056T11O11001	X532	✓	160	056T17E5315	G665	✓	76	056T17V99007	N353	✓	109	056T34F5306	D396	✓	54
056T11O11002	X533	✓	160	056T17F2043	G304	✓	47	056T17V99008	N355	✓	109	056T34F5308	G569	✓	53
056T11O15511	X512	✓	160	056T17F2045	G328	✓	47	056T17V99009	N377	✓	109	056T34F5321	P102	✓	51,123
056T11V5376	N568	✓	108	056T17F2047	K405	✓	51	056T17V99011	N708	✓	118	056T34F5322	P103	✓	51,123
056T11V5377	N600	✓	108	056T17F2051	G565	✓	53	056T17V99012	N711	✓	118	056T34F5323	P104	✓	51,123
056T11V5379	N180	✓	115	056T17F5302	G347	✓	47	056T17V99013	N761	✓	118	056T34F5324	P105	✓	51,123
056T11V5380	N181	✓	115	056T17F5320	G548	✓	51	056T17V99014	N758	✓	118	056T34F5325	P106	✓	51,123
056T11W5377	N604	✓	108	056T17F5321	G581	✓	53	056T17V99015	N755	✓	118	056T34F5326	P107	✓	54,123
056T11W5378	N608	✓	108	056T17F5322	G582	✓	53	056T17V99016	N705	✓	118	056T34F5328	G308	✓	47
056T11W5379	N182	✓	115	056T17F5323	G583	✓	53	056T17VD5326	N410	✓	112	056T34F5333	G309	✓	47
056T11W5380	N183	✓	115	056T17F5324	G584	✓	54	056T17VD5327	N412	✓	112	056T34F5334	G327	✓	47
056T17D2092	K004	✓	36	056T17F5325	G585	✓	54	056T17VD5328	N411	✓	112	056T34F5335	G345	✓	47
056T17D2093	G084	✓	36	056T17F5327	G387	✓	48	056T17VD5329	N430	✓	111	056T34F5336	G363	✓	48
056T17D2094	G063	✓	36	056T17F5329	G549	✓	51	056T17VD5330	N431	✓	111	056T34F5337	G368	✓	48
056T17D2095	G047	✓	36	056T17F5330	K806	✓	54	056T17VD5331	N432	✓	111	056T34F5338	G385	✓	48
056T17D2101	G100	✓	169	056T17F5336	K705	✓	53	056T17W5326	N653	✓	107	056T34F5342	J061	✓	123
056T17D2104	G106	✓	169	056T17F5337	K707	✓	53	056T17W5327	N611	✓	108	056T34F5343	J062	✓	123
056T17D2110	G086	✓	36	056T17F5338	K709	✓	53	056T17W5328	N313	✓	106	056T34F5344	J063	✓	123
056T17D2111	G082	✓	36	056T17F5339	K722	✓	54	056T17W5329	N291	✓	115	056T34F5345	J064	✓	123
056T17D2112	G065	✓	36	056T17F5340	K724	✓	54	056T17W5330	N468	✓	114	056T34F5346	J065	✓	123
056T17D2113	K003	✓	36	056T17F5348	D450	✓	98	056T17W5331	N465	✓	114	056T34F5347	J066	✓	123
056T17D2114	G062	✓	36	056T17F5349	D452	✓	98	056T17W5332	N470	✓	114	056T34F5348	K704	✓	53
056T17D2115	G242	✓	40	056T17F5350	D454	✓	98	056T17W5334	N628	✓	108	056T34F5349	K706	✓	53
056T17D2116	G243	✓	40	056T17F5355	G590	✓	54	056T17W5335	N621	✓	108	056T34F5350	K708	✓	53
056T17D2117	G964	✓	169	056T17F5356	G591	✓	54	056T17W5336	N293	✓	115	056T34F5351	K721	✓	54
056T17D2118	G961	✓	169	056T17F5357	D456	✓	98	056T17W5337	N294	✓	115	056T34F5352	K723	✓	54
056T17D2119	G962	✓	169	056T17F5358	D457	✓	98	056T17W5339	N623	✓	108	056T34F5353	K725	✓	54
056T17D2120	G963	✓	169	056T17G5312	G649	✓	76	056T17W5340	N320	✓	106	056T34F5940	E2000	✓	60
056T17D2121	G162	✓	169	056T17G5313	G661	✓	76	056T17W5341	N627	✓	108	056T34F15940	E2100	✓	56
056T17D2127	G244	✓	40	056T17G5314	G663	✓	76	056T17W5344	N322	✓	106	056T34F16001	E2150	✓	56
056T17D2128	G046	✓	36	056T17G5315	G829	✓	77	056T17W99002	N669	✓	107	056T34F16020	E2125	✓	56
056T17D2130	K049	✓	37	056T17G5316	G840	✓	77	056T17W99003	N666	✓	107	056T34G5303	G648	✓	76
056T17D3301	K063	✓	36	056T17G5317	G841	✓	77	056T17W99004	N633	✓	108	056T34G5304	G660	✓	76
056T17D3302	K064	✓	37	056T17G5318	G844	✓	77	056T17W99005	N632	✓	108	056T34G5305	G662	✓	76
056T17D3303	K065	✓	37	056T17G5319	G845	✓	77	056T17W99006	N668	✓	107	056T34T5303	D390	✓	53
056T17D3304	K066	✓	38	056T17G5320	G846	✓	77	056T17W99007	N715	✓	118	056T34T5306	P101	✓	51,123
056T17D3305	K067	✓	36	056T17G5321	G666	✓	76	056T17W99008	N770	✓	118	056T34T5308	J060	✓	123
056T17D3306	K068	✓	37	056T17G5322	G667	✓	76	056T17W99009	N721	✓	118	056T34T5309	K702	✓	53
056T17D3307	K069	✓	37	056T17G5323	G668	✓	76	056T17W99010	N765	✓	118	056T34V5301	N643	✓	107
056T17D3308	K080	✓	38	056T17T5305	G580	✓	53	056T17WD5326	N413	✓	112	056T34V5302	N645	✓	107
056T17D5309	K022	✓	37	056T17T5316	K703	✓	53	056T17WD5328	N417	✓	112	056T34V5303	N648	✓	107
056T17D5310	K041	✓	37	056T17V5326	N640	✓	107	056T17WD5329	N415	✓	112	056T34V5304	N651	✓	107
056T17D5329	G122	✓	169	056T17V5327	N641	✓	107	056T17WD5330	N433	✓	111	056T34V5305	N566	✓	108
056T17D5332	G127	✓	169	056T17V5328	N642	✓	107	056T17WD5331	N435	✓	111	056T34V5306	N569	✓	108
056T17D5336	G905	✓	36	056T17V5329	N644	✓	107	056T17WD5332	N437	✓	111	056T34V5307	N601	✓	108
056T17D5339	G908	✓	36	056T17V5330	N646	✓	107	056T34D5300	K027	✓	36	056T34V5308	N605	✓	108
056T17D5342	G921	✓	36	056T17V5331	N649	✓	107	056T34D5301	G080	✓	36	056T34V5309	N609	✓	108
056T17D5344	G923	✓	37	056T17V5332	N564	✓	108	056T34D5302	K000	✓	36	056T34V5312	N442	✓	115
056T17D5345	G140	✓	169	056T17V5336	N567	✓	108	056T34D5303	K009	✓	37	056T34V5313	N482	✓	114
056T17D5346	G141	✓	169	056T17V5337	N622	✓	108	056T34D5304	K025	✓	37	056T34V5314	N441	✓	115
056T17D5347	G142	✓	169	056T17V5338	N599	✓	108	056T34D5327	G205	✓	40	056T34V5315	N443	✓	115
056T17D5348	G143	✓	169	056T17V5340	N602	✓	108	056T34D5339	G289	✓	40	056T34V5316	N480	✓	114
056T17D5349	G144	✓	169	056T17V5342	N606	✓	108	056T34D5340	K048	✓	37	056T34V5317	N481	✓	114
056T17D5350	G145	✓	169	056T17V5346	N309	✓	106	056T34D5357	B193	✓	169	056T34V99001	N665	✓	107
056T17D5357	G965	✓	169	056T17V5347	N400	✓	115	056T34D5364	X251	✓	169,178	056T34V99002	N667	✓	107
056T17D5369	K061	✓	37	056T17V5348	N401	✓	115	056T34D5365	J049	✓	122	056T34V99011	N710	✓	118
056T17D5370	K062	✓	37	056T17V5349	N402	✓	115	056T34D5366	J050	✓	122	056T34V99012	N753	✓	118
056T17D5385	G967	✓	169	056T17V5352	N463	✓	114	056T34D5367	J048	✓	122	056T34V99013	N703	✓	118
056T17D5398	H803	✓	38	056T17V5353	N462	✓	114	056T34D5368	J047	✓	122	056T34V99014	N707	✓	118
056T17D5701	G161	✓	169	056T17V5354	N388	✓	116	056T34D5369	J051	✓	122	056T34V99015	N757	✓	118
056T17D15528	K081	✓	37	056T17V5355	N389	✓	116	056T34D5370	J052	✓	122	056T34V99016	N760	✓	118
056T17E5308	G646	✓	76	056T17V5356	N464	✓	114	056T34D5371	J053	✓	122	056T34VD5301	N450	✓	112
056T17E5309	G647	✓	76	056T17V15501	N620A	✓	108	056T34D6001	U244	✓	42	056T34VD5302	N451	✓	112
056T17E5310	G827	✓	77	056T17V99002	N375	✓	109	056T34F5301	D391	✓	53	056T34VD5303	N452	✓	112
056T17E5311	G828	✓	77	056T17V99003	N371	✓	109	056T34F5302	D392	✓	53	056T34WD5301	N453	✓	112
056T17E5312	G842	✓	77	056T17V99004	N373	✓	109	056T34F5303	D393	✓	53	056T34WD5302	N455	✓	112
056T17E5313	G843	✓	77	056T17V99005	N357	✓	109	056T34F5304	D394	✓	54	056T34WD5303	N457	✓	112

# Index

## Model Number/Catalog Number

MODEL NO.	CAT. NO.	STOCK	PAGE NO.	MODEL NO.	CAT. NO.	STOCK	PAGE NO.	MODEL NO.	CAT. NO.	STOCK	PAGE NO.	MODEL NO.	CAT. NO.	STOCK	PAGE NO.
056T34W99001	N662	✓	107	080T17FH5411	R370	✓	96	115D964P2	A946	✓	215	143TTDR14003	U129A	✓	135
056T34W99002	N631	✓	108	080T17FH5414	R373	✓	96	132MTFC6536	R331A	✓	95	143TTDR14004	E095		125
056T34W99003	N220	✓	109	080T17FH5511	R390	✓	96	132MTFC6537	R431A	✓	95	143TTDR14048	U123A		135
056T34W99004	N222	✓	109	080T17FH5514	R393	✓	96	132MTFC6586	R326A	✓	95	143TTDR14049	K634A	✓	40
056T34W99005	N224	✓	109	080T17V5326	R701	✓	117	132MTFC6587	R329A	✓	95	143TTDR16005	E798A	✓	42
056T34W99006	N226	✓	109	080T17V5327	R710	✓	117	132STFC6501	R327A	✓	95	143TTDR16006	GT2503	✓	139
056T34W99007	N230	✓	109	080T17V5328	R721	✓	117	132STFC6502	R330A	✓	95	143TTDR16007	GT4203	✓	129
056T34W99009	N228	✓	109	080T17V5329	R723	✓	117	132STFC6503	R427A	✓	95	143TTDR16008	GT4503	✓	139
056T34W99010	N232	✓	109	080T17V5330	R730	✓	117	132STFC6504	R430A	✓	95	143TTDR16009	GT2003	✓	129
056T34W99011	N234	✓	109	080T17V5331	R703	✓	117	132STFC6526	R328A	✓	95	143TTDR16010	GT2303	✓	139
056T34W99008	N236	✓	109	080T17V5332	R731	✓	117	132STFC6527	R428A	✓	95	143TTDR16011	GT4303	✓	139
056T34W99012	N238	✓	109	080T17V5333	R711	✓	117	132STFC6586	R353A	✓	95	143TTDR16012	GT4003	✓	129
056T8O5301	X506	✓	161	080T17W5326	R704	✓	117	143TBRFS301	I220	✓	30	143TTDR16013	GT4103	✓	129
056T8O5302	X507	✓	161,158	080T17W5327	R712	✓	117	143TBRFS376	I707	✓	29	143TTDR16014	GT4403	✓	139
056T8O5303	X511	✓	161	080T17W5328	R724	✓	117	143TCDR5303	I101	✓	22	143TTDR16015	GT2403	✓	139
056T8O5304	X527	✓	161	080T17W5329	R732	✓	117	143TCDR5328	Z401	✓	124	143TTDR16036	U922A		36
056T8O5306	X528	✓	160,173	080T34FH5301	R312	✓	94	143TCDR5330	Z420	✓	132	143TTDR16037	E912A	✓	42
056T8O5307	X530	✓	161	080T34FH5302	R315	✓	94	143TCFR5328	Z123	✓	99	143TTDR16039	GT4201	✓	129
056T8O5531	X529	✓	160,173	080T34FH5303	R415	✓	94	143TCWR17031	N685	✓	105	143TTDR16040	GT2501	✓	139
056T8O15504	X531	✓	160,173	080T34FH5305	R412	✓	94	143THEN8034	Y978	✓	89	143TTDR16041	GT4501	✓	139
063T17FH5326	R301	✓	94	080T34FH5413	R372	✓	96	143THTN8028	Y525	✓	88	143TTDR16042	GT4001	✓	129
063T17FH5327	R401	✓	94	080T34FH5416	R375	✓	96	143THTN8036	Y986	✓	90	143TTDR16043	GT2001	✓	129
063T17FH5402	R361	✓	96	080T34FH5513	R392	✓	96	143THTN9001	W505	✓	71	143TTDR16044	GT2301	✓	139
063T17FH5502	R381	✓	96	080T34FH5516	R395	✓	96	143THTN9005	W506	✓	71	143TTDR16045	GT4301	✓	139
063T34FH5301	R300	✓	94	090LT17FH6326	R319A	✓	94	143THTN9026	W501	✓	71	143TTDR16046	GT4204	✓	129
063T34FH5302	R303	✓	94	090LT17FH6327	R419A	✓	94	143THTN19033	W502	✓	71	143TTDR16047	GT4101	✓	129
063T34FH5303	R400	✓	94	090LT17FH6419	R378A	✓	96	143THTR5326	Y536	✓	86	143TTDR16048	GT2401	✓	139
063T34FH5304	R403	✓	94	090LT17FH6519	R398A	✓	96	143THTR15535	Y283	✓	85	143TTDR16049	GT4401	✓	139
063T34FH5401	R360	✓	96	090LT17W4026	R705	✓	117	143TTDR4005	E917	✓	37	143TTDR16052	U758-P	✓	42
063T34FH5404	R363	✓	96	090LT17W4027	R706	✓	117	143TTDR4006	E798	✓	37	143TTFN6501	E377		67
063T34FH5501	R380	✓	96	090LT17W4028	R707	✓	117	143TTDR4009	E123	✓	125	143TTFN6502	E378		67
063T34FH5504	R383	✓	96	090LT34FH6301	R321A	✓	95	143TTDR4011	U132	✓	135	143TTFN6505	E379		67
071T11FH5376	R302	✓	94	090LT34FH6302	R421A	✓	95	143TTDR4016	E120	✓	125	143TTFN6526	E374		67
071T11FH5403	R362	✓	96	090LT34FH6420	R379A	✓	96	143TTDR4017	E122	✓	125	143TTFN6563	E375		67
071T11FH5503	R382	✓	96	090LT34FH6520	R399A	✓	96	143TTDR4018	U128	✓	135	143TTFN6576	E373		67
071T17FH5326	R304	✓	94	090ST11FH6376	R314A	✓	94	143TTDR4019	U131	✓	135	143TTFN8076	H457	✓	49
071T17FH5327	R307	✓	94	090ST11FH6415	R374A	✓	96	143TTDR4022	E121	✓	125	143TTFN16040	E2201-P	✓	56
071T17FH5330	R404	✓	94	090ST11FH6515	R394A	✓	96	143TTDR4023	U130	✓	135	143TTFN16539	E376		67
071T17FH5331	R407	✓	94	090ST17FH6326	R316A	✓	94	143TTDR4024	E124	✓	125	143TTFR4003	E830	✓	48
071T17FH5405	R364	✓	96	090ST17FH6327	R416A	✓	94	143TTDR4025	U133	✓	135	143TTFR4010	U733	✓	54
071T17FH5408	R367	✓	96	090ST17FH6417	R376A	✓	96	143TTDR4034	E118	✓	125	143TTFR4015	U303		131
071T17FH5505	R384	✓	96	090ST17FH6517	R396A	✓	96	143TTDR4035	E100	✓	125	143TTFR4021	U305		131
071T17FH5508	R387	✓	96	090ST34FH6301	R318A	✓	94	143TTDR4037	U126	✓	135	143TTFR4028	E824		47
071T17V5326	R700	✓	117	090ST34FH6302	R418A	✓	94	143TTDR4040	E115	✓	125	143TTFR4034	U301		131
071T17V5327	R702	✓	117	090ST34FH6418	R377A	✓	96	143TTDR4041	E117	✓	125	143TTFR4040	U300		131
071T17V5328	R720	✓	117	090ST34FH6518	R397A	✓	96	143TTDR4042	U122	✓	135	143TTFR4046	U302		131
071T17V5329	R722	✓	117	100LTC6501	R351A	✓	95	143TTDR4043	U125	✓	135	143TTFR4302	C201A	✓	51
071T34FH5301	R306	✓	94	100LTC6502	R451A	✓	95	143TTDR4046	E119	✓	125	143TTFR4303	U304A	✓	131
071T34FH5302	R309	✓	94	100LTC6526	R322A	✓	95	143TTDR4047	E116	✓	125	143TTFR4329	C220A	✓	51
071T34FH5303	R406	✓	94	100LTC6527	R422A	✓	95	143TTDR4048	U124	✓	135	143TTFR4333	C230A		51
071T34FH5304	R409	✓	94	100LTC6536	R352A	✓	95	143TTDR4049	U127	✓	135	143TTFR5302	C201	✓	51
071T34FH5407	R366	✓	96	100LTC6537	R452A	✓	95	143TTDR4051	U418	✓	37	143TTFR5333	C230		51
071T34FH5410	R369	✓	96	100LTC6576	R320A	✓	94	143TTDR4055	U922	✓	37	143TTFR5376	H700	✓	47
071T34FH5507	R386	✓	96	100LTC6577	R420A	✓	94	143TTDR4061	U416	✓	36	143TTFR5582	E2003	✓	60
071T34FH5510	R389	✓	96	100LTC6586	R317	✓	94	143TTDR6513	E783	✓	37	143TTFR5642	E2001	✓	60
080T11FH5376	R305	✓	94	111A271P111	A961	✓	215	143TTDR5348	E901	✓	36	143TTFR6010	GT1203	✓	64
080T11FH5377	R308	✓	94	111A271P113	A965	✓	212	143TTDR5351	E912	✓	37	143TTFR6032	GT1201	✓	64
080T11FH5378	R311	✓	94	112A515AKG4	AG228	✓	213	143TTDR5376	H150	✓	36	143TTFR15582	E2103	✓	56
080T11FH5406	R365	✓	96	112A515ASG2	AG229	✓	213	143TTDR5401	H180	✓	36	143TTFR15642	E2101	✓	56
080T11FH5409	R368	✓	96	112MTFC6511	R324A	✓	95	143TTDR6007	GT0403	✓	129	143TTFR16001	E2153	✓	56
080T11FH5412	R371	✓	96	112MTFC6512	R424A	✓	95	143TTDR6008	GT0503	✓	129	143TTFR16003	GT1403	✓	64
080T11FH5506	R385	✓	96	112MTFC6536	R325A	✓	95	143TTDR6027	U758	✓	42	143TTFR16004	GT5203	✓	133
080T11FH5509	R388	✓	96	112MTFC6537	R425A	✓	95	143TTDR6028	U245	✓	42	143TTFR16005	GT5003	✓	133
080T11FH5512	R391	✓	96	112MTFC6576	R323A	✓	95	143TTDR6030	GT0401	✓	129	143TTFR16006	GT5103	✓	133
080T17FH5326	R310	✓	94	113A617AG001	A948	✓	215	143TTDR6031	GT0501	✓	129	143TTFR16007	GT3003	✓	133
080T17FH5327	R313	✓	94	113A620AYP1	A949	✓	215	143TTDR6051	U418A	✓	37	143TTFR16008	GT5303	✓	141
080T17FH5330	R410	✓	94	115D963P1	A947	✓	215	143TTDR6052	U417A	✓	37	143TTFR16009	GT3303	✓	141
080T17FH5331	R413	✓	94	115D964P1	A945	✓	215	143TTDR6313	E783A	✓	37	143TTFR16010	GT3103	✓	133



## Model Number/Catalog Number

MODEL NO.	CAT. NO.	STOCK	PAGE NO.	MODEL NO.	CAT. NO.	STOCK	PAGE NO.	MODEL NO.	CAT. NO.	STOCK	PAGE NO.	MODEL NO.	CAT. NO.	STOCK	PAGE NO.
143TTFR16011	GT3403	✓	141	143TTWD16032	N766	✓	118	145TTDR4016	E132		125	145TTDR6004	GT0506	✓	129
143TTFR16012	GT5403	✓	141	143TTWD16033	N716	✓	118	145TTDR4017	U140		135	145TTDR6006	GT0509	✓	130
143TTFR16013	GT3203	✓	133	143TTWR6028	N626A	✓	108	145TTDR4018	U143		135	145TTDR6007	GT0406	✓	129
143TTFR16014	GT5503	✓	141	143TTWR14002	N202	✓	109	145TTDR4021	E131		125	145TTDR6013	GT0409	✓	130
143TTFR16015	GT3503	✓	141	143TTWR14031	N203	✓	109	145TTDR4022	E134		125	145TTDR6028	U759	✓	42
143TTFR16020	E2128		56	143TTWR14032	N201	✓	109	145TTDR4023	U142		135	145TTDR6029	U760	✓	42
143TTFR16032	GT3101	✓	133	145TBD5302	I102	✓	22	145TTDR4024	U145		135	145TTDR6030	GT0507	✓	129
143TTFR16038	E2151	✓	56	145TBD5303	I145		23	145TTDR4025	E144		126	145TTDR6031	GT0504	✓	129
143TTFR16039	GT1401	✓	64	145TBD5304	Z404		124	145TTDR4034	E102		125	145TTDR6034	GT0404	✓	129
143TTFR16040	E2126	✓	56	145TBD5309	Z304	✓	103	145TTDR4035	E128		125	145TTDR6036	GT0407	✓	129
143TTFR16042	GT5201	✓	133	145TBD5337	I127	✓	22,183,189	145TTDR4037	U138		135	145TTDR6039	U246	✓	42
143TTFR16043	GT5401	✓	141	145TBD5345	I147	✓	25,167	145TTDR4040	E125		125	145TTDR6076	U265	✓	42
143TTFR16044	GT3501	✓	141	145TBF5301	I204		30	145TTDR4041	E127		125	145TTDR6126	U420A	✓	37
143TTFR16045	GT5501	✓	141	145TBF5302	I205		30	145TTDR4042	U134		135	145TTDR6127	U421A	✓	37
143TTFR16046	GT3201	✓	133	145TBF5303	I221	✓	30	145TTDR4043	U137		135	145TTDR6132	U423A	✓	37
143TTFR16047	GT3001	✓	133	145TBF5305	C282		32	145TTDR4046	E136		125	145TTDR6133	U424A	✓	37
143TTFR16048	GT5001	✓	133	145TBF5306	C284		32	145TTDR4047	E129		125	145TTDR14007	C102A	✓	40
143TTFR16049	GT3301	✓	141	145TBF5309	T031	✓	191	145TTDR4048	U136		135	145TTDR14049	K622A	✓	40
143TTFR16050	GT5301	✓	141	145TBF5327	I201	✓	30	145TTDR4049	U139		135	145TTDR14087	C162A	✓	40
143TTFR16051	GT3401	✓	141	145TBF5328	Z118	✓	99	145TTDR4051	E138		125	145TTDR14088	C150A	✓	40
143TTFR16052	GT5101	✓	133	145TBF5333	I311		190	145TTDR4060	E104		125	145TTDR16008	U906A	✓	42
143TTFR16053	E2001A	✓	60	145TBF5334	I700	✓	30	145TTDR4066	E135		125	145TTDR16010	E932A	✓	42
143TTGN4020	C301A		77	145TBF5336	I702		190	145TTDR4067	E137		125	145TTDR16013	GT4006	✓	129
143TTGN4030	U020		78	145TBF5337	C281		32	145TTDR4068	U146		135	145TTDR16014	GT2306	✓	139
143TTGN4062	C320A	✓	77	145TBF5341	Z128	✓	99	145TTDR4069	U149		135	145TTDR16015	GT2006	✓	129
143TTGN6501	U058A	✓	79	145TBWD5301	N288	✓	113	145TTDR4072	E126		125	145TTDR16016	GT4506	✓	139
143TTGN6526	U001A	✓	79	145TBWD5326	N275	✓	113	145TTDR4073	E139		125	145TTDR16017	GT2506	✓	139
143TTGN6530	U020A	✓	79	145TBWD5327	N274	✓	113	145TTDR4074	U148		135	145TTDR16018	GT4206	✓	129
143TTGN6532	U986A	✓	79	145TBWD5328	N289	✓	113	145TTDR4075	U151		135	145TTDR16019	GT4106	✓	129
143TTGN6551	C361A	✓	75	145TBWD5329	N287	✓	113	145TTDR4078	E785		37	145TTDR16020	GT2406	✓	139
143TTGN7076	H350	✓	79	145TCDR5328	Z403		124	145TTDR4080	E934		37	145TTDR16021	GT4406	✓	139
143TTGR16001	I506	✓	76	145TCDR5329	Z422		132	145TTDR4103	U905		37	145TTDR16022	GT4009	✓	130
143TTGR16005	I507	✓	76	145TCDR5331	I146	✓	25,167	145TTDR4105	E932		37	145TTDR16023	GT2009	✓	130
143TTGR16026	I502	✓	76	145TCWR5326	N683	✓	105	145TTDR4110	E143		126	145TTDR16024	GT2309	✓	140
143TTGR16030	I503		76	145TEFR5326	Z615	✓	92	145TTDR4111	U153		136	145TTDR16025	GT4309	✓	140
143TTTC4026	E826	✓	49	145TEFR5327	Z616	✓	92	145TTDR4112	U156		136	145TTDR16054	U923A		37
143TTN4001	E833	✓	49	145THEN8034	Y979	✓	89	145TTDR4115	E140		126	145TTDR16059	U924A		37
143TTN4003	E831		49	145THFR5326	Y523		84	145TTDR4117	U152		136	145TTDR16061	E913A	✓	42
143TTN4005	E835		49	145THFR5329	Y368	✓	84	145TTDR4118	U155		136	145TTDR16062	E914A	✓	37,42
143TTN4028	E825		49	145THFR5330	Y369	✓	84	145TTDR4121	E141		126	145TTDR16077	E934A	✓	42
143TTN4030	E828		49	145THTN6046	Y551	✓	86	145TTDR4123	U154		136	145TTDR16073	GT4004	✓	129
143TTN6001	E351	✓	56	145THTN6060	Y557	✓	86	145TTDR4124	U157		136	145TTDR16074	GT2004	✓	129
143TTN6501	E651	✓	67	145THTN8029	Y526	✓	88	145TTDR4128	U419		37	145TTDR16075	GT2304	✓	139
143TTN6502	E463	✓	67	145THTN8037	Y590	✓	88	145TTDR4130	U923		37	145TTDR16301	GT2409	✓	140
143TTN6505	E851		67	145THTN8043	Y987	✓	90	145TTDR4134	U422	✓	37	145TTDR16302	GT4209	✓	130
143TTN6526	E649	✓	67	145THTN9001	W511		71	145TTDR4136	U924		37	145TTDR16303	GT2509	✓	140
143TTN6530	E666	✓	67	145THTN9026	W507	✓	71	145TTDR4303	E105		126	145TTDR16304	GT4509	✓	140
143TTN6563	E461	✓	67	145THTN9027	W513	✓	71	145TTDR4307	E142		126	145TTDR16305	GT4109	✓	130
143TTN6576	E648	✓	67	145THTN9076	W503		71	145TTDR4317	E096	✓	125	145TTDR16306	GT4409	✓	140
143TTVD5326	N403	✓	115	145THTN17034	Y285	✓	85	145TTDR4341	C122A	✓	40	145TTDR16307	GT4306	✓	139
143TTVD5327	N466	✓	114	145THTN19002	W512		71	145TTDR4354	U135A	✓	135	145TTDR16308	U401A	✓	41
143TVR5326	N647	✓	107	145THTN19033	W514		71	145TTDR4355	U150A		135	145TTDR16326	GT4304	✓	139
143TVR5327	N650	✓	107	145THTN19045	W508		71	145TTDR4356	U147A	✓	135	145TTDR16327	GT2504	✓	139
143TVR5329	N310	✓	106	145THTN19079	W638		71	145TTDR5312	C103	✓	40	145TTDR16328	GT4504	✓	139
143TTWD4002	N456	✓	112	145THTR5326	Y538	✓	86	145TTDR5315	M311	✓	126	145TTDR16329	GT4104	✓	129
143TTWD4527	N434A	✓	111	145THTR5328	Y522	✓	84	145TTDR5316	M312	✓	126	145TTDR16330	GT2404	✓	139
145TTWD4528	N438A	✓	111	145THTR5329	Y366	✓	84	145TTDR5401	H181	✓	36	145TTDR16331	GT4404	✓	139
143TTWD6001	N454A	✓	112	145THTR5330	Y367		84	145TTDR5632	E902	✓	37	145TTDR16332	GT4107	✓	129
143TTWD6002	N456A	✓	112	145THTR5376	Y537	✓	86	145TTDR5633	E903	✓	37	145TTDR16333	GT2407	✓	139
143TTWD6026	N414A	✓	112	145THTR15540	Y284	✓	85	145TTDR5647	H952		191	145TTDR16334	GT4407	✓	139
143TTWD14002	N152	✓	116	145THTR16031	Y611	✓	86	145TTDR5665	E914		37	145TTDR16335	GT2007	✓	129
143TTWD14003	N483	✓	114	145THTR16032	Y612	✓	86	145TTDR5701	Y465	✓	185	145TTDR16336	GT4007	✓	129
143TTWD14031	N151	✓	116	145TTDR4003	E919		37	145TTDR5702	Y466	✓	185	145TTDR16337	GT2307	✓	139
143TTWD14032	N467	✓	114	145TTDR4005	U906		37	145TTDR5703	Y449	✓	185	145TTDR16338	GT4207	✓	129
143TTWD16002	N444	✓	115	145TTDR4010	E133		125	145TTDR5704	Y450		185	145TTDR16339	GT2507	✓	139
143TTWD16003	N763	✓	118	145TTDR4011	U141		135	145TTDR5705	Y451	✓	185	145TTDR16340	GT4507	✓	139
143TTWD16004	N713	✓	118	145TTDR4012	U144		135	145TTDR5706	Y452	✓	185	145TTDR16342	GT4307	✓	139
143TTWD16031	N292	✓	115	145TTDR4015	E130		125	145TTDR6002	U247	✓	42	145TTDR16348	U759-P	✓	42

# Index

## Model Number/Catalog Number

MODEL NO.	CAT. NO.	STOCK	PAGE NO.	MODEL NO.	CAT. NO.	STOCK	PAGE NO.	MODEL NO.	CAT. NO.	STOCK	PAGE NO.	MODEL NO.	CAT. NO.	STOCK	PAGE NO.
145TTDR16349	U760-P	✓	42	145TFR16045	E2132	✓	57	145TTN6526	E652	✓	67	161L113ADG4	AG128	✓	210
145TFR6501	E382		67	145TFR16046	GT1404	✓	64	145TTN6527	E654	✓	68	161L113ADG5	AG129	✓	210
145TFR6521	E383		67	145TFR16047	GT1407	✓	64	145TTN6529	E667	✓	67	161L113ADG14	AG130	✓	210
145TFR6835	E386		68	145TFR16055	GT5407	✓	141	145TTN6530	E668	✓	68	161L185AAG1	AG192	✓	205
145TFR16045	E2207-P	✓	57	145TFR16056	GT3407	✓	141	145TTN6576	E650	✓	67	161L186AAG1	AG195	✓	206
145TFR16046	E2204-P	✓	57	145TFR16057	GT5107	✓	133	145TTN6584	E462		67	161L187BAG1	A534	✓	205
145TFR3002	E2006	✓	60	145TFR16058	GT5004	✓	133	145TTN6834	E464	✓	67	161L187BCG1	A535	✓	205
145TFR4005	E840		48	145TFR16059	GT3004	✓	133	145TTN6835	E467	✓	68	161L188BAG1	A536	✓	206
145TFR4007	E843		48	145TFR16060	GT3304	✓	141	145TTN18531	S503		187	161L188BCG1	A537	✓	206
145TFR4017	U309		131	145TFR16061	GT5304	✓	141	145TTN18532	S553		187	161L197ABG1	A958	✓	215
145TFR4023	U311		131	145TFR16062	GT5204	✓	133	145TTN18577	S501		187	161L197ABG11	A959	✓	215
145TFR4029	E836		48	145TFR16063	GT3204	✓	133	145TVR5030	N629	✓	108	161L198AAG9	A956	✓	215
145TFR4032	E845		48	145TFR16064	GT3504	✓	141	145TVR5301	N652	✓	107	161L198AAG10	A957	✓	215
145TFR4038	E838		48	145TFR16065	GT5504	✓	141	145TVR5302	N610	✓	108	161L190AAP1	AG697	✓	215
145TFR4039	E847		48	145TFR16066	GT5007	✓	133	145TVR5326	N607	✓	108	161L528AAG1	AG234	✓	214
145TFR4045	U307		131	145TFR16067	GT3007	✓	133	145TWD4027	N405	✓	115	180LTC6538	R343A	✓	95
145TFR4046	U703		54	145TFR16068	GT3307	✓	141	145TWD6001	N458A	✓	112	180LTC6588	R338A	✓	95
145TFR4048	U306		131	145TFR16069	GT5307	✓	141	145TWD6026	N404A		115	180MTC6511	R342A	✓	95
145TFR4050	U312		131	145TFR16070	GT5207	✓	133	145TWD6027	N405A	✓	115	180MTC6536	R340A	✓	95
145TFR4052	U705		54	145TFR16071	GT3207	✓	133	145TWD6029	N418A	✓	112	182TBR5301	I206	✓	30
145TFR4054	U308		131	145TFR16072	GT3507	✓	141	145TWD14002	N154	✓	116	182TBR5326	I212	✓	30
145TFR4070	U706		54	145TFR16073	GT5507	✓	141	145TWD14003	N156	✓	116	182TCDR7013	Z309		103
145TFR4126	U708		54	145TFR16074	GT5104	✓	133	145TWD14004	N485	✓	114	182TCDR7354	Z424		132
145TFR4128	U314		131	145TFR16075	GT5404	✓	141	145TWD14005	N484	✓	114	182TCDR8005	Z425		132
145TFR4306	C202A	✓	51	145TFR16079	GT1202	✓	64	145TWD14031	N153	✓	116	182TCDR8007	C173		27
145TFR4307	C236A	✓	52	145TFR16078	E2102	✓	56	145TWD14032	N155	✓	116	182TCDR17079	I141		21
145TFR4310	U363	✓	131	145TFR16080	E2127		56	145TWD14033	N471	✓	114	182TCDW7001	I103A	✓	22
145TFR4332	C221A	✓	51	145TFR16326	GT3404	✓	141	145TWD14034	N469	✓	114	182TCDW7026	I112A	✓	22
145TFR4340	C231A	✓	51	145TFR16329	E2007A	✓	60	145TWD16002	N446	✓	115	182TCDW7074	Z405A	✓	124
145TFR4378	C250A	✓	51	145TFR16331	E2004A	✓	60	145TWD16003	N445	✓	115	182TCDW7318	Z406A	✓	124
145TFR5340	C231		51	145TGN4022	C302A		77	145TWD16004	N718	✓	118	182TCFW7072	Z119A	✓	99
145TFR5341	C232		51	145TGN4035	U021		78	145TWD16005	N768	✓	118	182TCFW9061	Z112A	✓	100
145TFR5359	C403	✓	98	145TGN4040	U022		78	145TWD16031	N771	✓	118	182TCWR7026	N684	✓	105
145TFR5360	C401	✓	98	145TGN4337	C321A	✓	77	145TWD16032	N720	✓	118	182TEFR5326	Z617	✓	92
145TFR5382	C400	✓	98	145TGN4338	C322A	✓	77	145TWR4301	N655A	✓	107	182THS8048	Y980	✓	89
145TFR6009	GT1206	✓	64	145TGN6501	U059A	✓	79	145TWR4326	N654A	✓	107	182THFR5329	Y370	✓	85
145TFR6033	E2004	✓	60	145TGN6526	U002A	✓	79	145TWR5301	N655	✓	107	182THFR5330	Y371		85
145TFR6035	E2007	✓	60	145TGN6527	U003A	✓	79	145TWR6001	N613A	✓	108	182THFS19101	W504		71
145TFR6040	GT1207	✓	64	145TGN6536	C362A	✓	75	145TWR6026	N612A	✓	108	182THFW7729	Y1999	✓	85
145TFR6058	GT1204	✓	64	145TGN6537	U021A	✓	79	145TWR6027	N312A	✓	106	182THFW7730	Y270A	✓	85
145TFR6078	E2002	✓	60	145TGN6540	U022A	✓	79	145TWR6029	N321A	✓	106	182HTL7726	Y541	✓	86
145TFR13002	E2106	✓	57	145TGN6549	C363A	✓	75	145TWR6033	N630	✓	108	182HTL7736	Y558	✓	86
145TFR14011	U310A	✓	131	145TGN6550	U988A		79	145TWR6076	N323	✓	106	182HTL17041	Y286	✓	85
145TFR14045	U313A	✓	131	145TGN6576	U039A	✓	79	145TWR14003	N204	✓	109	182HTS8028	Y527	✓	88
145TFR14048	C232A		51	145TGN16532	U987A		79	145TWR14004	N206	✓	109	182HTS8048	Y988	✓	90
145TFR15581	E2152		56	145TGR16002	I512	✓	76	145TWR14031	N205	✓	109	182HTS9001	W517		72
145TFR16001	E2156		57	145TGR16004	I513	✓	76	145TWR14032	N360		109	182HTS9026	W519	✓	72
145TFR16005	GT1406	✓	64	145TGR16030	I509	✓	76	145TWR14033	N362		109	182HTS9076	W509		71
145TFR16009	GT5006	✓	133	145TGR16038	I508	✓	76	145TWR17031	N380		109	182HTS19033	W520		72
145TFR16010	GT3006	✓	133	145TGR16039	I515	✓	76	145TWR17032	N382		109	182TPFSA10094	SY006	✓	91
145TFR16011	GT5306	✓	141	145TGR16040	I514	✓	76	160LTC6513	R339A	✓	95	182TTDB6001	GT0012	✓	45
145TFR16012	GT5106	✓	133	145TGR16076	I504	✓	76	160LTC6538	R337A	✓	95	182TTDB6007	GT0412	✓	130
145TFR16013	GT3106	✓	133	145TGR16080	I505		76	160LTC6588	R335A	✓	95	182TTDB6008	GT0512	✓	130
145TFR16014	GT3406	✓	141	145TTC4026	E837	✓	49	160MTC6511	R333A	✓	95	182TTDB6012	GT2412	✓	140
145TFR16015	GT5406	✓	141	145TTC4027	E846	✓	49	160MTC6512	R336A	✓	95	182TTDB6013	GT2512	✓	140
145TFR16016	GT3306	✓	141	145TTN4001	E842	✓	49	160MTC6536	R334A	✓	95	182TTDB6026	GT0010	✓	45
145TFR16017	GT5206	✓	133	145TTN4003	E841		49	160MTC6586	R332A	✓	95	182TTDB6032	GT0410	✓	130
145TFR16018	GT3206	✓	133	145TTN4005	E844		49	161L110AA1	AG195	✓	211	182TTDB6033	GT0510	✓	130
145TFR16019	GT5506	✓	141	145TTN4030	U606		49	161L110AAG4	A518	✓	211	182TTDB6037	GT2410	✓	140
145TFR16020	E2131		57	145TTN4032	U601		49	161L113AAG1	AG109	✓	210	182TTDB6038	GT2510	✓	140
145TFR16021	GT3506	✓	141	145TTN4035	E839	✓	49	161L113AAG2	AG110	✓	210	182TTDB6076	GT0005	✓	45
145TFR16033	E2104	✓	56	145TTN4040	E848	✓	49	161L113AAG3	AG111	✓	210	182TTDB7325	M1315	✓	126
145TFR16035	E2107	✓	57	145TTN4076	E829	✓	49	161L113AAG4	AG112	✓	210	182TTDB7601	M1316	✓	126
145TFR16036	GT3104	✓	133	145TTN4080	U672	✓	49	161L113AAG5	AG113	✓	210	182TTDR4036	E147		126
145TFR16037	GT3107	✓	133	145TTN6001	E353	✓	57	161L113AAG6	AG114	✓	210	182TTDR4075	U925		38
145TFR16038	E2154	✓	56	145TTN6501	E653	✓	67	161L113AAG9	AG115	✓	210	182TTDR4104	E933		38
145TFR16039	E2157	✓	57	145TTN6505	E852		67	161L113ADG1	AG125	✓	210	182TTDR4106	U908		38
145TFR16040	E2129	✓	56	145TTN6521	E466		67	161L113ADG3	AG127	✓	210	182TTDR4113	U168		136

## Model Number/Catalog Number

MODEL NO.	CAT. NO.	STOCK	PAGE NO.	MODEL NO.	CAT. NO.	STOCK	PAGE NO.	MODEL NO.	CAT. NO.	STOCK	PAGE NO.	MODEL NO.	CAT. NO.	STOCK	PAGE NO.
182TTDR4116	E150		126	182TTFC6005	GT1109	✓	61	182TTWW4028	N656B	✓	107	184TTDB6076	GT0008	✓	45
182TTDR4117	E152		126	182TTFC6026	GT1010	✓	61	182TTWW6026	N614B	✓	108	184TTDR4034	E108	✓	126
182TTDR4118	U164		136	182TTFC6030	GT1110	✓	61	182TTWW6027	N314B	✓	106	184TTDR4105	E938		38
182TTDR4119	U167		136	182TTFC6031	U609A	✓	57	182TTWW14031	N207	✓	109	184TTDR4112	U180		136
182TTDR4122	E151		126	182TTFC6076	GT1005	✓	61	182TTWW16002	N634	✓	108	184TTDR4115	E160		126
182TTDR4123	E154		126	182TTFC6080	GT1105	✓	61	184TBDR5301	Z504		183	184TTDR4116	E162		126
182TTDR4124	U166		136	182TTFN4101	L409A	✓	49	184TBDR5326	Z502	✓	183	184TTDR4117	U176		136
182TTDR4125	U169		136	182TTFN6557	U867A		66	184TBDR7324	Z313		103	184TTDR4118	U179		136
182TTDR4140	E145		126	182TTFN16047	E2210-P	✓	57	184TBDR7375	I119		183,189	184TTDR4121	E161		126
182TTDR4142	U158		136	182TTFR4013	U736		54	184TBDR7628	I305		189	184TTDR4122	E164		126
182TTDR4143	U161		136	182TTFR4015	U315		131	184TBDR7631	I128	✓	189	184TTDR4123	U178		136
182TTDR4146	E146		126	182TTFR4021	U317		131	184TBDR7632	I131	✓	189	184TTDR4124	U181		136
182TTDR4148	U160		136	182TTFR4056	U320		131	184TBDR7634	I308		189	184TTDR4140	E155		126
182TTDR4149	U163		136	182TTFR4320	C381	✓	54	184TBDW7001	I108A	✓	22,183	184TTDR4141	E157		126
182TTDR8353	H953		191	182TTFS4005	U604		49	184TBDW7009	Z307A	✓	103	184TTDR4142	U170		136
182TTDR8067	C123	✓	40	182TTFS6501	E390		68	184TBDW7026	I114A	✓	22,183	184TTDR4143	U173		136
182TTDR14026	M803A		149	182TTFS6505	E392		68	184TBDW7369	Z1124		156	184TTDR4146	E156		126
182TTDR14027	M801A		149	182TTFS6576	E380		67	184TBDW7630	I130A	✓	189	184TTDR4147	E159		126
182TTDW4002	E107A	✓	126	182TFW4027	C223B	✓	52	184TBDW7631	I128A	✓	189	184TTDR4148	U172		136
182TTDW4027	E1904	✓	38	182TFW4040	U1608	✓	48	184TBDW7632	I131A	✓	189	184TTDR4149	U175		136
182TTDW4028	C123B	✓	40	182TFW4302	U316A	✓	131	184TBDW7656	Z506A		183	184TTDR4153	U427	✓	38
182TTDW4030	E1915		38	182TFW4327	U605A	✓	48	184TBDW17007	Z408A	✓	124	184TTDR4173	M804A		149
182TTDW4033	E106A	✓	126	182TFW4330	U319A	✓	131	184TBDW17008	I104A	✓	22	184TTDR4178	E918		37
182TTDW4083	E1799	✓	37	182TFW4345	C383A		54	184TBDW17011	Z427A	✓	132	184TTDR7612	Y303	✓	103
182TTDW4135	E148A	✓	126	182TFW6001	E2009	✓	60	184TBF7315	Z433	✓	124	184TTDR9040	H954	✓	191
182TTDW4147	E149A		126	182TFW6026	E2010	✓	60	184TBF7726	I214	✓	30	184TTDW4003	E937A		38
182TTDW4303	E098	✓	126	182TFW6076	E2005	✓	60	184TBFW7034	I315A	✓	32,101,190	184TTDW4110	E163A	✓	126
182TTDW4304	E153A	✓	126	182TFW7634	C1223	✓	52	184TBFW7041	I314A	✓	32,101,190	184TTDW4027	E1905	✓	38
182TTDW4338	U159A	✓	136	182TFW14004	C203B	✓	52	184TBFW7070	Z114A	✓	100	184TTDW4030	E1916	✓	38
182TTDW4339	U162A		136	182TFW14005	M875A		153	184TBFW7315	Z433A	✓	124	184TTDW4039	U299		136
182TTDW6001	U1248	✓	43	182TFW14026	M876A		153	184TBFW7701	I223A	✓	30	184TTDW4135	E158A	✓	126
182TTDW6030	E1930	✓	42	182TFW16001	E2109	✓	57	184TBFW7726	I214A	✓	30	184TTDW4136	U171A		136
182TTDW6076	U1266	✓	42	182TFW16002	E2159	✓	57	184TBFW7737	Z121A	✓	99	184TTDW4153	U427A	✓	38
182TTDW7101	H182A		37	182TFW16020	E2134	✓	57	184TBFW17044	I213A	✓	30	184TTDW6001	U249A	✓	43
182TTDW7203	Y485A		185	182TFW16021	C381B	✓	54	184TBFW17045	Z120A	✓	99	184TTDW6031	E1931	✓	43
182TTDW7211	Y409A	✓	185	182TFW16026	E2110	✓	57	184TCDR7076	I142		22	184TTDW6076	U1267	✓	42
182TTDW7412	Y1484	✓	185	182TFW16027	C383B	✓	54	184TCDR7626	Z426		132	184TTDW7101	H183A		37
182TTDW7411	Y467A	✓	185	182TFW16030	C382B	✓	54	184TCDR7627	C174		27	184TTDW7209	Y1487	✓	185
182TTDW7413	Y1453	✓	185	182TFW16038	E2160	✓	57	184TCDW7026	I113A	✓	22	184TTDW7215	Y412A	✓	185
182TTDW14008	C104B	✓	40	182TFW16040	E2135	✓	57	184TCDW7047	Z407A	✓	124	184TTDW7230	Y468A	✓	185
182TTDW14011	U165A	✓	136	182TFW16076	E2105	✓	56	184TCDW7615	Z305A	✓	103	184TTDW7286	Y454A	✓	185
182TTDW14029	E097	✓	126	182TFW16080	E2130		56	184TCDW7617	Z306A	✓	103	184TTDW7287	Y486A	✓	185
182TTDW16008	U908A	✓	43	182TFW16082	E2155		56	184TCFW9057	Z113A	✓	100	184TTDW7357	M1317	✓	126
182TTDW16009	U914	✓	42	182TGN4068	C323A	✓	77	184THFS9001	W523	✓	72	184TTDW7358	M115A	✓	136
182TTDW16010	U402C	✓	41	182TGN4315	C303A	✓	77	184THFS9026	W525	✓	72	184TTDW7611	Y302A	✓	103
182TTDW16029	E915B	✓	42	182TGN6501	U060A	✓	79	184THFS9030	W526	✓	72	184TTDW7612	Y1303	✓	103
182TTDW16048	U425B		38	182TGN6526	U004A	✓	79	184THFS19006	W524		72	184TTDW14001	E109A	✓	126
182TTDW16049	U426B	✓	38	182TGN6530	U023A	✓	79	184THFW7726	Y1372	✓	85	184TTDW14017	C105B	✓	40
182TTDW16059	U410A	✓	41	182TGN6536	C368A	✓	75	184THFW7736	Y373A	✓	85	184TTDW14027	C124B	✓	40
182TTDW16063	E1930-P	✓	42	182TGN6541	U989A		79	184THL7726	Y543	✓	86	184TTDW14078	C152A		40
182TTDW16082	U925A		38	182TGN6569	C364A	✓	75	184THL7736	Y559	✓	86	184TTDW14079	U177A	✓	136
182TTFB6003	GT1209	✓	64	182TGN6576	U040A	✓	79	184THL7776	Y540	✓	86	184TTDW16001	U404B	✓	41
182TTFB6004	GT1309	✓	64	182TGS4030	U023		78	184THL17038	Y287	✓	85	184TTDW16027	E938A	✓	43
182TTFB6006	GT3109	✓	134	182TTL7034	C405	✓	98	184THS8028	Y564	✓	88	184TTDW16038	U428B	✓	38
182TTFB6007	GT1409	✓	64	182TTTS6001	E216	✓	57	184THS8056	Y989	✓	90	184TTDW16040	E916B	✓	43
182TTFB6008	GT3209	✓	134	182TTTS6030	E303		57	184THS9076	W515		71	184TTDW16041	U917		38
182TTFB6012	GT3409	✓	142	182TTTS6501	E601	✓	68	184TPFA10095	SY007	✓	91	184TTDW16043	U403A		41
182TTFB6013	GT3509	✓	142	182TTTS6505	E853		68	184TTDB4026	E719	✓	38	184TTDW16061	E1931-P	✓	43
182TTFB6028	GT1210	✓	64	182TTTS6526	E616	✓	68	184TTDB6001	GT0015	✓	45	184TTDW16076	U915	✓	42
182TTFB6029	GT1310	✓	64	182TTTS6530	E669	✓	68	184TTDB6007	GT0415	✓	130	184TTFB6003	GT1212	✓	64
182TTFB6031	GT3110	✓	134	182TTTS6538	E470	✓	68	184TTDB6008	GT0515	✓	130	184TTFB6004	GT1312	✓	64
182TTFB6032	GT1410	✓	64	182TTTS6576	E632	✓	67	184TTDB6012	GT2415	✓	140	184TTFB6006	GT3112	✓	134
182TTFB6033	GT3210	✓	134	182TTTS6578	E465		67	184TTDB6013	GT2515	✓	140	184TTFB6007	GT1412	✓	64
182TTFB6037	GT3410	✓	142	182TTTS18532	S506		187	184TTDB6026	GT0013	✓	45	184TTFB6008	GT3212	✓	134
182TTFB6038	GT3510	✓	142	182TWD6031	N406A	✓	115	184TTDB6032	GT0413	✓	130	184TTFB6012	GT3412	✓	142
182TTFB6078	GT1205	✓	64	182TWD14033	N157	✓	116	184TTDB6033	GT0513	✓	130	184TTFB6013	GT3512	✓	142
182TTFB6079	GT1305	✓	64	182TWD14032	N472	✓	114	184TTDB6037	GT2413	✓	140	184TTFB6028	GT1213	✓	64
182TTFC6001	GT1009	✓	61	182TTWW4026	N1614	✓	108	184TTDB6038	GT2513	✓	140	184TTFB6029	GT1313	✓	64

# Index

## Model Number/Catalog Number

MODEL NO.	CAT. NO.	STOCK	PAGE NO.	MODEL NO.	CAT. NO.	STOCK	PAGE NO.	MODEL NO.	CAT. NO.	STOCK	PAGE NO.	MODEL NO.	CAT. NO.	STOCK	PAGE NO.
184TTFB6031	GT3113	✓	134	184TTGN4313	C304A	✓	77	213TTDB6038	GT2516	✓	140	213TTFBA6028	GT1216	✓	64
184TTFB6032	GT1413	✓	64	184TTGN6501	U061A	✓	79	213TTDB6026	GT0016	✓	45	213TTFBA6029	GT1316	✓	64
184TTFB6033	GT3213	✓	134	184TTGN6526	U005A	✓	79	213TTDB6032	GT0416	✓	130	213TTFBA6032	GT1416	✓	64
184TTFB6037	GT3413	✓	142	184TTGN6530	U024A	✓	79	213TTDB6033	GT0516	✓	130	213TTFBA6078	GT1211	✓	64
184TTFB6038	GT3513	✓	142	184TTGN6537	C369A	✓	75	213TTDB6012	GT2418	✓	140	213TTFBA6079	GT1311	✓	64
184TTFB6078	GT1208	✓	64	184TTGN6544	U990A		79	213TTDB6013	GT2518	✓	140	213TTF6001	GT1015	✓	61
184TTFB6079	GT1308	✓	64	184TTGN6575	C365A	✓	75	213TTDB6076	GT0011	✓	45	213TTF6005	GT1115	✓	61
184TTF6001	GT1012	✓	61	184TTGN6576	U041A	✓	79	213TTDBA4028	E906	✓	38	213TTF6006	U671A	✓	57
184TTF6005	GT1112	✓	61	184TTGS4030	U024	✓	78	213TTDBA7048	M1322	✓	127	213TTF6026	GT1016	✓	61
184TTF6006	U615A	✓	57	184TTTL7041	C406	✓	98	213TTDC6001	U764	✓	43	213TTF6027	U629A	✓	57
184TTF6026	GT1013	✓	61	184TTTL7083	C404	✓	98	213TTDC6003	U283	✓	43	213TTF6030	GT1116	✓	61
184TTF6027	U618A	✓	57	184TTTL7084	C402	✓	98	213TTDC6026	U763	✓	43	213TTF6031	U631A	✓	57
184TTF6030	GT1113	✓	61	184TTTS6576	E633	✓	68	213TTDC6029	U281	✓	43	213TTF6076	GT1011	✓	61
184TTF6031	U620A	✓	57	184TTTS6582	E468	✓	68	213TTDC6076	U268	✓	42	213TTF6080	GT1111	✓	61
184TTF6076	GT1008	✓	61	184TTTS18577	S504		187	213TTDC6079	U279	✓	42	213TTFN4103	L411A	✓	49
184TTF6080	GT1108	✓	61	184TTTS18578	S554		187	213TTDW4003	E939		38	213TTFN6550	U869A	✓	66
184TTF6081	E002	✓	57	184TTWD6031	N407A	✓	115	213TTDW4007	E174		127	213TTFN16326	E203-P	✓	57
184TTFN4102	L410B	✓	49	184TTWD14002	N486	✓	114	213TTDW4008	E172		127	213TTF6005	U671		49
184TTFN6555	U868A	✓	66	184TTWD14003	N158	✓	116	213TTDW4009	E170		127	213TTF6030	U631		49
184TTFN16056	E202-P	✓	57	184TTWD14032	N473	✓	114	213TTDW4010	E171		127	213TTF6501	E396		68
184TTF614101	L410A	✓	49	184TTWD14033	N159	✓	116	213TTDW4011	U188		137	213TTF6526	E618	✓	68
184TTFR4003	U611		48	184TTWD16002	N447	✓	115	213TTDW4012	U190		137	213TTF6530	E671	✓	68
184TTFR4005	U614		48	184TTWW4002	N657B	✓	107	213TTDW4013	U191		137	213TTF6531	E476	✓	68
184TTFR4013	U738		54	184TTWW4028	N658B	✓	107	213TTDW4014	U193		137	213TTF6576	E634	✓	68
184TTFR4021	U323		131	184TTWW6001	N615B	✓	108	213TTDW4022	E111		127	213TTF6594	E471	✓	68
184TTFR4038	U616	✓	48	184TTWW6003	N317A	✓	106	213TTDW4023	E173	✓	127	213TTF67238	Y381		184
184TTFR4345	C387	✓	54	184TTWW6004	N315A	✓	106	213TTDW4025	U192		137	213TFW4003	U622		48
184TTF6005	U615		49	184TTWW6026	N616B	✓	108	213TTDW4030	E758		38	213TFW4005	U625		48
184TTF6030	U620		49	184TTWW6027	N316B	✓	106	213TTDW4033	E167		127	213TFW4007	U740		55
184TTF6501	E602	✓	68	184TTWW14004	N210	✓	109	213TTDW4038	E169		127	213TFW4008	U742		55
184TTF6505	E655	✓	68	184TTWW14005	N208	✓	109	213TTDW4039	U184		136	213TFW4009	U327		131
184TTF6526	E617	✓	68	184TTWW14031	N209	✓	109	213TTDW4041	E166		127	213TFW4010	U331		131
184TTF6530	E670	✓	68	184TTWW16002	N635	✓	108	213TTDW4042	E165		127	213TFW4011	U328		138
184TTF6576	E388		68	200LFC6511	R345A	✓	95	213TTDW4044	U182		136	213TFW4012	U332		138
184TTF6810	E472	✓	68	200LFC6513	R348A	✓	95	213TTDW4047	E110		127	213TFW4022	U329		131
184TTF6844	E473	✓	68	200LFC6538	R346A	✓	95	213TTDW4048	E168		127	213TFW4028	U627	✓	48
184TTF67290	Y380		184	200LFC6588	R341A	✓	95	213TTDW4049	U183		136	213TFW4030	U630		48
184TFW4009	U322A	✓	131	200LFC6589	R344A	✓	95	213TTDW4051	U185		136	213TFW4038	U335		131
184TFW4040	U1619		48	213TBFW7001	I224	✓	30	213TTDW4052	U187		136	213TFW4047	U334	✓	131
184TFW4345	C387A	✓	54	213TBFW7010	Z434	✓	124	213TTDW4070	U429		38	213TFW4345	C391		55
184TFW4727	U616A	✓	48	213TBFW7026	I216	✓	30	213TTDW4071	U926		38	213TFW6001	E2015	✓	60
184TFW4760	U325A	✓	131	213TBFW7027	Z117	✓	100	213TTDW4078	U907	✓	38	213TFW6026	E2016	✓	60
184TFW4914	U372	✓	138	213TCDW7001	I105	✓	22,183	213TTDW7053	H955		191	213TFW6076	E2011	✓	60
184TFW4915	U360	✓	131	213TCDW7002	Z410	✓	124	213TTDW7201	Y489	✓	185	213TFW14010	M881A		153
184TFW6001	E2012	✓	60	213TCDW7003	Z429	✓	132	213TTDW7202	Y488		185	213TFW14011	C205A	✓	52
184TFW6026	E2013	✓	60	213TCDW7026	I117		22	213TTDW14013	U189A	✓	137	213TFW14045	C225A	✓	52
184TFW6076	E2008	✓	60	213TCDW7027	Z409	✓	124	213TTDW14014	C106A	✓	40	213TFW14080	M877A		153
184TFW7727	H1668	✓	48	213TCDW7028	Z428		132	213TTDW14054	M807A		149	213TFW14081	C253A		52
184TFW8617	C1238	✓	52	213TCDW7076	I143		22	213TTDW14057	C125A		40	213TFW16001	E2115	✓	57
184TFW8641	C1224	✓	52	213THES8053	Y981	✓	89	213TTDW14059	U186A		136	213TFW16008	C389A	✓	55
184TFW14004	C204B	✓	52	213THFS8028	Y595	✓	88	213TTDW14084	M802A		149	213TFW16020	E2140		57
184TFW14021	C238B	✓	52	213THFS9026	W532	✓	72	213TTDW14102	H184A		37	213TFW16026	E2116	✓	57
184TFW14026	M879A		153	213THFS9030	W533	✓	72	213TTDW16010	U432A		41	213TFW16035	C390A	✓	55
184TFW14028	U326A		131	213THFS9076	W521	✓	72	213TTDW16060	U430A	✓	38	213TFW16036	C391A	✓	55
184TFW16001	E2112	✓	57	213THFW7726	Y994	✓	85	213TTDW16061	U926A		38	213TFW16039	E2016A	✓	60
184TFW16002	E2162		57	213THFW7736	Y995		85	213TTDW16063	U405A	✓	41	213TFW16040	E2141	✓	57
184TFW16006	C385B	✓	54	213THHL7726	Y545	✓	86	213TTDW16073	U430A-P	✓	43	213TFW16076	E2111	✓	57
184TFW16020	E2137	✓	57	213THHL7736	Y560	✓	86	213TTFB6006	GT3115	✓	134	213TFW16078	C384A	✓	54
184TFW16026	E2113	✓	57	213THHL7776	Y542	✓	86	213TTFB6008	GT3215	✓	134	213TFW16081	E2136		57
184TFW16027	C386B	✓	54	213THTS8038	Y565	✓	88	213TTFB6012	GT3415	✓	142	213TFW16082	E2161		57
184TFW16038	E2163	✓	57	213THTS8071	Y990	✓	90	213TTFB6013	GT3515	✓	142	213TGN4067	C325A	✓	77
184TFW16029	C387B	✓	54	213THTS9001	W530	✓	72	213TTFB6031	GT3116	✓	134	213TGN6501	U062A	✓	80
184TFW16040	E2138	✓	57	213THTS19005	W531		72	213TTFB6033	GT3216	✓	134	213TGN6526	U006A	✓	80
184TFW16051	C380B	✓	54	213TPFSA10096	SY008	✓	91	213TTFB6037	GT3416	✓	142	213TGN6528	C366A	✓	75
184TFW16076	E2108	✓	57	213TTDB6001	GT0018	✓	45	213TTFB6038	GT3516	✓	142	213TGN6536	C370A	✓	75
184TFW16079	E2158		57	213TTDB6007	GT0418	✓	130	213TTFBA6003	GT1215	✓	64	213TGN6540	U991A	✓	80
184TFW16081	E2133		57	213TTDB6008	GT0518	✓	130	213TTFBA6004	GT1315	✓	64	213TGN6576	U042A	✓	79
184TTGN4072	C324A	✓	77	213TTDB6037	GT2416	✓	140	213TTFBA6007	GT1415	✓	64	213TGN16537	U025A	✓	80

## Model Number/Catalog Number

MODEL NO.	CAT. NO.	STOCK	PAGE NO.	MODEL NO.	CAT. NO.	STOCK	PAGE NO.	MODEL NO.	CAT. NO.	STOCK	PAGE NO.	MODEL NO.	CAT. NO.	STOCK	PAGE NO.
213TTGN16548	U991A-P	✓	80	215TTDB6038	GT2519	✓	140	215TTFBA6078	GT1214	✓	64	215TTGN6526	U007A	✓	80
213TTGS4030	U025		78	215TTDB6076	GT0014	✓	45	215TTFBA6079	GT1314	✓	64	215TTGN6528	C367A	✓	75
213TTGS14015	C305	✓	77	215TTDC6001	U766	✓	43	215TTFC6001	GT1018	✓	61	215TTGN6539	U992A	✓	80
213TTTL7034	C407	✓	98	215TTDC6003	U286	✓	43	215TTFC6002	U636A	✓	58	215TTGN6576	U043A	✓	79
213TTTS6001	E218	✓	57	215TTDC6026	U765	✓	43	215TTFC6005	GT1118	✓	61	215TTGN16532	U026A	✓	80
213TTTS6501	E603	✓	68	215TTDC6029	U284	✓	43	215TTFC6006	U637A	✓	58	215TTGN16534	C371A		75
213TTTS6502	E475	✓	68	215TTDC6076	U269	✓	43	215TTFC6026	GT1019	✓	61	215TTGN16539	U992A-P	✓	80
213TTTS6505	E656	✓	68	215TTDC6079	U280	✓	43	215TTFC6027	U639A	✓	58	215TTGS4030	U026		78
213TTTS17077	S507	✓	187	215TTDW4003	E788	✓	38	215TTFC6030	GT1119	✓	61	215TTGS14020	C306	✓	77
213TTTS17078	S557		187	215TTDW4007	E184		127	215TTFC6031	U641A	✓	58	215TTTL7050	C408	✓	98
213TTWD6031	N408A	✓	115	215TTDW4008	E180		127	215TTFC6076	GT1014	✓	61	215TTTS17077	S510	✓	187
213TTWD14002	N160	✓	116	215TTDW4009	E181		127	215TTFC6077	U621A	✓	57	215TTTS17078	S560	✓	187
213TTWD14032	N161	✓	116	215TTDW4010	E182		127	215TTFC6080	GT1114	✓	61	215TTWD6031	N409A	✓	115
213TTWD16002	N448	✓	115	215TTDW4011	U200		137	215TTFN6546	U870A	✓	66	215TTWD14002	N162	✓	116
213TTWR4001	N659A	✓	107	215TTDW4012	U202		137	215TTFN16057	E204-P	✓	58	215TTWD14032	N163	✓	116
213TTWR4027	N318	✓	106	215TTDW4013	U203		137	215TTFS4005	U637		49	215TTWD16002	N449	✓	115
213TTWR6002	N617A	✓	108	215TTDW4014	U205		137	215TTFS4030	U641		49	215TTWR6026	N619A	✓	108
213TTWR6026	N618A	✓	108	215TTDW4022	E113	✓	127	215TTFS6030	E306		58	215TTWR6027	N319A	✓	106
213TTWR6027	N318A	✓	106	215TTDW4023	E183		127	215TTFS6501	E604	✓	68	215TTWR7026	N661	✓	107
213TTWR7026	N660	✓	107	215TTDW4025	U204		137	215TTFS6505	E657		68	215TTWW14007	N214	✓	109
213TTWW14031	N211	✓	109	215TTDW4028	E907	✓	38	215TTFS6526	E619	✓	68	215TTWW14008	N664	✓	107
215TBD7361	Z125		156	215TTDW4030	E759	✓	38	215TTFS6527	E479	✓	68	215TTWW14009	N212	✓	109
215TBDW7013	Z315		103	215TTDW4032	E179		127	215TTFS6530	E672	✓	68	215TTWW14031	N213	✓	109
215TBDW7026	I115	✓	22,183	215TTDW4041	E175		127	215TTFS6576	E635	✓	68	215TTWW16003	N637	✓	108
215TBDW7027	Z413	✓	124	215TTDW4042	E176		127	215TTFS6580	E683		68	225MTFC6501	R500	✓	95
215TBDW7028	I116	✓	22,183	215TTDW4043	E177		127	215TTFS6807	E478	✓	68	225MTFC6526	R501	✓	95
215TBDW7029	Z411	✓	124	215TTDW4044	U194		137	215TTFS6881	E474	✓	68	225MTFC6586	R347A	✓	95
215TBDW7030	Z432		132	215TTDW4047	E112		127	215TTFS7290	Y382	✓	184	225STFC6526	R349A	✓	95
215TBDW7045	Z430		132	215TTDW4048	E178		127	215TTFS14103	L421A	✓	49	250MTFC6501	R503	✓	95
215TBDW7079	I144		22	215TTDW4049	U195		137	215TTFW4003	U634		48	250MTFC6526	R504	✓	95
215TBDW7362	Z126		156	215TTDW4051	U196		137	215TTFW4005	E821	✓	48	250MTFC6586	R350A	✓	95
215TBFW7001	I225	✓	30	215TTDW4052	U199		137	215TTFW4013	U743		55	254THEN8058	Y982	✓	89
215TBFW7010	Z435	✓	124	215TTDW4053	U197		137	215TTFW4014	U336		132	254THEN8059	Y983	✓	89
215TBFW7026	I215	✓	30	215TTDW4071	M810A		149	215TTFW4015	U338		132	254THFA8038	Y597	✓	88
215TBFW7027	I217	✓	30	215TTDW4078	E935	✓	38	215TTFW4022	U337		132	254THFA9001	W544	✓	72
215TBFW7028	Z115	✓	100	215TTDW4315	U435		41	215TTFW4028	E822		48	254THFA9026	W546	✓	72
215TBFW7029	Z122	✓	99	215TTDW7048	M326	✓	127	215TTFW4030	U640		48	254THFA9030	W547	✓	72
215TBFW7044	Z116	✓	100	215TTDW7053	H956	✓	191	215TTFW4033	U718		55	254THFA9076	W534	✓	72
215TCDW7002	Z412	✓	124	215TTDW7201	Y491		185	215TTFW4035	U339		132	254THFA9101	W529	✓	72
215TCDW7003	Z308	✓	103	215TTDW7203	Y415	✓	185	215TTFW4036	U341		132	254THFA19065	W546-P	✓	72
215TCDW7004	Z431	✓	132	215TTDW7204	Y455	✓	185	215TTFW4047	U340		132	254THL5726	Y549	✓	86
215TCDW7012	Z314		103	215TTDW7205	Y469	✓	185	215TTFW4345	C394		55	254THL5736	Y562	✓	86
215TCDW17002	I106	✓	22	215TTDW7301	Y304	✓	103	215TTFW6001	E2018	✓	60	254THL5776	Y546	✓	86
215THFS8029	Y596	✓	88	215TTDW7376	Y201		188	215TTFW6026	E2019	✓	60	254THNA8058	Y509	✓	88
215THFS9001	W537	✓	72	215TTDW7377	Y202	✓	188	215TTFW6076	E2014	✓	60	254THNA8071	Y992	✓	90
215THFS9026	W539	✓	72	215TTDW14018	M813A		149	215TTFW14021	M884A		153	254TPFA10088	SY010	✓	91
215THFS9076	W527	✓	72	215TTDW14020	U201A	✓	137	215TTFW14022	C237A	✓	52	254TTDC6001	U768	✓	43
215THFS9101	W522		72	215TTDW14071	C126A		40	215TTFW14024	C206A	✓	52	254TTDC6003	U289	✓	43
215THFS19006	W538		72	215TTDW14073	U198A		137	215TTFW14040	M885A		153	254TTDC6026	U767	✓	43
215THFS19033	W540	✓	72	215TTDW14087	M805A		149	215TTFW14041	C226A	✓	52	254TTDC6029	U287	✓	43
215THFS19077	W528		72	215TTDW14110	H185A		38	215TTFW14083	M880A		153	254TTDC6076	U254	✓	43
215THFW7726	Y996	✓	85	215TTDW16061	U433A		41	215TTFW14084	C254A		52	254TTDC6079	U282	✓	43
215THFW7736	Y997		85	215TTDW16073	U431A-P	✓	43	215TTFW14301	U357	✓	132	254TTDCA6001	GT0024	✓	45
215THL7726	Y547	✓	86	215TTDW17206	Y490		185	215TTFW14302	U366		138	254TTDCA6007	GT0424	✓	130
215THL7736	Y561	✓	86	215TTFB6006	GT3118	✓	134	215TTFW16001	E2118	✓	58	254TTDCA6008	GT0524	✓	130
215THL7776	Y544	✓	86	215TTFB6008	GT3218	✓	134	215TTFW16005	C392A	✓	55	254TTDCA6012	GT2424	✓	140
215THS8038	Y566	✓	88	215TTFB6012	GT3418	✓	142	215TTFW16020	E2143		58	254TTDCA6013	GT2524	✓	140
215THS8071	Y991	✓	90	215TTFB6013	GT3518	✓	142	215TTFW16026	E2119	✓	58	254TTDCA6026	GT0022	✓	45
215TPFA10097	SY009	✓	91	215TTFB6031	GT3119	✓	134	215TTFW16040	E2144	✓	58	254TTDCA6032	GT0422	✓	130
215TTDB6001	GT0021	✓	45	215TTFB6033	GT3219	✓	134	215TTFW16041	C393A	✓	55	254TTDCA6033	GT0522	✓	130
215TTDB6007	GT0421	✓	130	215TTFB6037	GT3419	✓	142	215TTFW16042	C394A		55	254TTDCA6037	GT2422	✓	140
215TTDB6008	GT0521	✓	130	215TTFB6038	GT3519	✓	142	215TTFW16047	E2019A	✓	60	254TTDCA6038	GT2522	✓	140
215TTDB6012	GT2421	✓	140	215TTFBA6003	GT1218	✓	65	215TTFW16076	E2114	✓	57	254TTDCA6076	GT0017	✓	45
215TTDB6013	GT2521	✓	140	215TTFBA6004	GT1318	✓	64	215TTFW16079	C388A	✓	54	254TTDN16056	U436A	✓	41
215TTDB6026	GT0019	✓	45	215TTFBA6007	GT1418	✓	65	215TTFW16080	E2139	✓	57	254TTDX4006	E1191	✓	127
215TTDB6032	GT0419	✓	130	215TTFBA6028	GT1219	✓	65	215TTFW16081	E2164		57	254TTDX4007	E190	✓	127
215TTDB6033	GT0519	✓	130	215TTFBA6029	GT1319	✓	64	215TTGN4065	C326A	✓	77	254TTDX4008	U214	✓	137
215TTDB6037	GT2419	✓	140	215TTFBA6032	GT1419	✓	65	215TTGN6501	U063A	✓	80	254TTDX4010	U215	✓	137

# Index

## Model Number/Catalog Number

MODEL NO.	CAT. NO.	STOCK	PAGE NO.	MODEL NO.	CAT. NO.	STOCK	PAGE NO.	MODEL NO.	CAT. NO.	STOCK	PAGE NO.	MODEL NO.	CAT. NO.	STOCK	PAGE NO.
254TTDX4012	U216		137	254TTFL4035	U723		55	256TTDC6079	U285	✓	43	256TTFCA6033	GT3225	✓	134
254TTDX4014	U212		137	254TTFL4036	U349		132	256TTDCA6001	GT0027	✓	45	256TTFCA6037	GT3425	✓	142
254TTDX4015	E193		127	254TTFL14004	U643		48	256TTDCA6007	GT0427	✓	130	256TTFCA6038	GT3525	✓	142
254TTDX4016	U217		137	254TTFL14005	U645		48	256TTDCA6008	GT0527	✓	130	256TTFCA6076	GT1020	✓	61
254TTDX4017	U213		137	254TTFL14008	U345A	✓	138	256TTDCA6012	GT2427	✓	140	256TTFCA6078	GT1220	✓	65
254TTDX4018	U900		38	254TTFL14009	C207A		52	256TTDCA6013	GT2527	✓	140	256TTFCA6080	GT1120	✓	61
254TTDX4019	E192		127	254TTFL14037	C227A	✓	52	256TTDCA6026	GT0025	✓	45	256TTFL4006	U351		132
254TTDX4020	E194		127	254TTFL14078	C255A		52	256TTDCA6032	GT0425	✓	130	256TTFL4010	U350		132
254TTDX4024	E195		127	254TTFL16001	E2121	✓	58	256TTDCA6033	GT0525	✓	130	256TTFL4012	U352		132
254TTDX4028	E908	✓	38	254TTFL16020	E2146		58	256TTDCA6037	GT2425	✓	140	256TTFL4031	U354		132
254TTDX4030	E760	✓	38	254TTFL16026	E2122	✓	58	256TTDCA6038	GT2525	✓	140	256TTFL4036	U353		132
254TTDX4039	E188		127	254TTFL16036	E2122-P	✓	58	256TTDCA6076	GT0020	✓	45	256TTFL4038	U355		132
254TTDX4041	U210		137	254TTFL16040	E2147	✓	58	256TTDN14102	H187A	✓	38	256TTFL14027	U651		48
254TTDX4060	U209		137	254TTFL16076	E2117	✓	57	256TTDN16009	U439A		41	256TTFL14030	E998		48
254TTDX4074	U206		137	254TTFL16077	E2142		57	256TTDN16011	M722		150	256TTFL16002	E2123	✓	58
254TTDX4075	U207		137	254TFNA4030	U648		49	256TTDN16049	U438A		41	256TTFL16020	E2148		58
254TTDX4315	U437		41	254TFNA6001	E220		58	256TTDN16053	M718		150	256TTFL16033	E2124	✓	58
254TTDX4340	U208		137	254TFNA6026	E205		58	256TTDX4004	U225		137	256TTFL16038	E2124-P	✓	58
254TTDX4341	U211		137	254TFNA6030	E307	✓	58	256TTDX4006	U103		128	256TTFL16040	E2149	✓	58
254TTDX4343	E185		127	254TFNA6076	E235	✓	57	256TTDX4013	E786	✓	38	256TTFL16076	E2120	✓	58
254TTDX4344	E186		127	254TFNA6501	E605	✓	68	256TTDX4019	U104		128	256TTFL16077	E2145		58
254TTDX4345	E187		127	254TFNA6503	E658		68	256TTDX4020	U501		144	256TTFNA4005	U650		50
254TTDX7201	Y470		185	254TFNA6515	E481	✓	68	256TTDX4021	U102		128	256TTFNA4030	U653		50
254TTDX7208	Y418	✓	185	254TFNA6526	E620	✓	68	256TTDX4022	U224		137	256TTFNA6001	E221	✓	58
254TTDX7278	Y456	✓	185	254TFNA6528	E673	✓	68	256TTDX4023	U226		137	256TTFNA6026	E206	✓	58
254TTDX7377	Y203		188	254TFNA6529	E482	✓	68	256TTDX4024	U500		144	256TTFNA6030	E308	✓	58
254TTDX8338	H957		191	254TFNA6576	E636	✓	68	256TTDX4027	E909	✓	38	256TTFNA6076	E236	✓	58
254TTDX14062	E114A	✓	127	254TFNA6578	E684		68	256TTDX4032	E761		38	256TTFNA6501	E606	✓	69
254TTDX14064	M814A		149	254TFNA6590	E477	✓	68	256TTDX4041	U100		128	256TTFNA6503	E659	✓	69
254TTDX14088	M808A		149	254TFNA7012	M888		153	256TTDX4047	U101		128	256TTFNA6523	E484	✓	69
254TTDX14089	C155A		40	254TFNA7210	Y383		184	256TTDX4059	U223		137	256TTFNA6526	E621	✓	69
254TTDX14104	H186A	✓	38	254TFNA14084	M883A		153	256TTDX4063	U219		137	256TTFNA6528	E674	✓	69
254TTDX16042	E722A	✓	43	254TFNA14103	L412A	✓	49	256TTDX4064	U218		137	256TTFNA6529	E485	✓	69
254TTDX16043	E722A-P	✓	43	254TFNA16074	E205-P	✓	58	256TTDX4065	U221		137	256TTFNA6576	E637	✓	68
254TTDX16082	E733A	✓	43	254TFNA16568	H711A	✓	66	256TTDX4075	E197		128	256TTFNA6578	E685		68
254TTFC6002	U644A	✓	58	254TFNA16838	E620-P	✓	68	256TTDX4094	M811A		149	256TTFNA6596	E480	✓	68
254TTFC6006	U638A	✓	58	254TFPA4005	U638		49	256TTDX4310	M821A		149	256TTFNA7028	M893		153
254TTFC6027	U647B	✓	58	254TTGN4030	U027		78	256TTDX4315	U439		41	256TTFNA7250	Y384	✓	184
254TTFC6031	U648A	✓	58	254TTGN6507	E502		80	256TTDX4326	E198		128	256TTFNA14016	M892A		153
254TTFC6077	U633A	✓	57	254TTGN6531	E503	✓	80	256TTDX4328	U220		137	256TTFNA14084	M886A		153
254TTFC6081	E005	✓	57	254TTGN6576	E500		80	256TTDX4329	E199		128	256TTFNA14086	C256A		52
254TTFCA6001	GT1021	✓	61	254TTGN14042	C327A	✓	77	256TTDX7101	H187	✓	38	256TTFNA14101	L413A	✓	49
254TTFCA6003	GT1221	✓	65	254TTGN16541	U027A	✓	80	256TTDX7207	Y492		185	256TTFNA16070	E206-P	✓	58
254TTFCA6005	GT1121	✓	61	254TTGN16549	E503-P	✓	80	256TTDX7253	Y471		185	256TTFNA16574	U872A	✓	66
254TTFCA6006	GT3121	✓	134	254TTGP14013	C307A	✓	77	256TTDX7263	Y457		185	256TTFNA16855	E621-P	✓	69
254TTFCA6007	GT1421	✓	65	254TTTNA17077	S513	✓	187	256TTDX7264	Y458	✓	185	256TTGN4030	U028		78
254TTFCA6008	GT3221	✓	134	254TTTNA18530	S518		187	256TTDX7391	Y204	✓	188	256TTGN6531	E506	✓	80
254TTFCA6012	GT3421	✓	142	256TBDX7028	Z127		156	256TTDX14039	M818A		149	256TTGN6576	E501		80
254TTFCA6013	GT3521	✓	142	256THEN17031	Y984	✓	89	256TTDX14087	C156A		40	256TTGN14011	C308A		77
254TTFCA6026	GT1022	✓	61	256THFNA8038	Y598	✓	88	256TTDX16032	E723A	✓	43	256TTGN14044	C328A	✓	77
254TTFCA6028	GT1222	✓	65	256THFNA9001	W551	✓	72	256TTDX16033	E723A-P	✓	43	256TTGN16509	E505	✓	80
254TTFCA6030	GT1122	✓	61	256THFNA9026	W553	✓	72	256TTDX16078	E734A	✓	43	256TTGN16540	U028A	✓	80
254TTFCA6031	GT3122	✓	134	256THFNA9076	W541	✓	72	256TTFC6002	U649A	✓	58	256TTGN16552	E506-P	✓	80
254TTFCA6032	GT1422	✓	65	256THFNA9101	W536	✓	72	256TTFC6027	U652B	✓	58	256TTTNA18577	S566		187
254TTFCA6033	GT3222	✓	134	256THFNA19033	W554	✓	72	256TTFC6031	U653A	✓	58	256TTTNA18578	S516	✓	187
254TTFCA6037	GT3422	✓	142	256THFNA19056	W553-P	✓	72	256TTFC6077	U642A	✓	58	256TTTNA18601	S564		187
254TTFCA6038	GT3522	✓	142	256THFNA19081	W542		72	256TTFC6081	E006	✓	58	280MTC6588	R505	✓	95
254TTFCA6076	GT1017	✓	61	256THTL5776	Y548	✓	86	256TTFCA6001	GT1024	✓	62	280STFC6501	R506	✓	95
254TTFCA6078	GT1217	✓	64	256THTNA7026	Y552	✓	86	256TTFCA6003	GT1224	✓	65	280STFC6526	R507	✓	95
254TTFCA6080	GT1117	✓	61	256THTNA7036	Y563	✓	86	256TTFCA6005	GT1124	✓	62	280STFC6586	R502	✓	95
254TTFL4006	U344		132	256THTNA8038	Y510	✓	88	256TTFCA6006	GT3124	✓	134	284THEN8032	Y985	✓	89
254TTFL4009	U343		138	256THTNA8071	Y993	✓	90	256TTFCA6008	GT3224	✓	134	284THFNA9026	W560	✓	72
254TTFL4010	U346		132	256TPFSA10087	SY011	✓	91	256TTFCA6012	GT3424	✓	142	284THFNA9076	W548	✓	72
254TTFL4011	U356		138	256TTDC6001	U770	✓	43	256TTFCA6013	GT3524	✓	142	284THFNA19048	W560-P	✓	72
254TTFL4027	U646A	✓	48	256TTDC6003	U291	✓	43	256TTFCA6026	GT1025	✓	62	284THFNA19084	W549	✓	72
254TTFL4031	U348		132	256TTDC6026	U769	✓	43	256TTFCA6028	GT1225	✓	65	284THFNA19033	W561	✓	72
254TTFL4033	U721		55	256TTDC6029	U290	✓	43	256TTFCA6030	GT1125	✓	62	284THFNA19102	W543		72
254TTFL4034	U347		132	256TTDC6076	U255	✓	43	256TTFCA6031	GT3125	✓	134	284THFPA8028	Y569	✓	88

## Model Number/Catalog Number

MODEL NO.	CAT. NO.	STOCK	PAGE NO.	MODEL NO.	CAT. NO.	STOCK	PAGE NO.	MODEL NO.	CAT. NO.	STOCK	PAGE NO.	MODEL NO.	CAT. NO.	STOCK	PAGE NO.
284THFPA8038	Y511	✓	88	284TTFCA6077	E978A	✓	58	286TSTFCA6003	GT1230	✓	65	286TTFNA6576	E639	✓	69
284THFPA8086	Y395		88	284TTFCA6006	GT3127	✓	134	286TSTFCA6005	GT1130	✓	62	286TTFNA6580	E695		69
284THTNA7026	Y553	✓	86	284TTFCA6008	GT3227	✓	134	286TSTFNA6001	E223	✓	58	286TTFNA6876	E486		69
284THTNA7036	Y567		86	284TTFCA6012	GT3427	✓	142	286TSTFNA6501	E608	✓	69	286TTFNA7260	Y386	✓	184
284TPFSA10112	SY012	✓	91	284TTFCA6013	GT3527	✓	142	286TSTFNA6804	E490	✓	69	286TTFNA14085	M894A		153
284TSHFNA9001	W558	✓	72	284TTFCA6026	GT1028	✓	62	286TSTFPA4005	E819		50	286TTFNA14106	L415A	✓	49
284TSHFNA9005	W559		72	284TTFCA6028	GT1228	✓	65	286TSTGN6501	E563		80	286TTFNA16070	E208-P	✓	58
284TSTDC6001	U772	✓	43	284TTFCA6030	GT1128	✓	62	286TSTGN16531	U077A		80	286TTFNA16572	U874A	✓	66
284TSTDC6003	U292	✓	43	284TTFCA6032	GT3128	✓	134	286TTDC6026	U773	✓	43	286TTFNA16847	E623-P	✓	69
284TSTDC6001	GT0030	✓	45	284TTFCA6033	GT3228	✓	134	286TTDC6029	E763A	✓	43	286TTFPA4030	E817		50
284TSTDN16031	E793A		43	284TTFCA6037	GT3428	✓	142	286TTDC6076	U257	✓	43	286TTFPA14011	M900A		153
284TSTDP4002	U504		144	284TTFCA6038	GT3528	✓	142	286TTDCA6007	GT0433	✓	130	286TTFPA14063	M901A		153
284TSTDP4004	U901		39	284TTFCA6076	GT1023	✓	61	286TTDCA6008	GT0533	✓	130	286TTGN6537	E564	✓	80
284TSTDR14007	U505		144	284TTFCA6080	GT1123	✓	61	286TTDCA6012	GT2433	✓	140	286TTGN16533	U030A		80
284TSTDR16003	E1008	✓	43	284TTFNA6026	E207	✓	58	286TTDCA6013	GT2533	✓	140	286TTGN16546	E564-P	✓	80
284TSTFC6002	E975A	✓	58	284TTFNA6030	E309	✓	58	286TTDCA6026	GT0031	✓	45	286TTGN16577	E507		80
284TSTFC6036	E999A	✓	58	284TTFNA6076	E237	✓	58	286TTDCA6032	GT0431	✓	130	286TTGP4030	U030		78
284TSTFCA6001	GT1027	✓	62	284TTFNA6526	E622	✓	69	286TTDCA6033	GT0531	✓	130	286TTTNA18577	S522		187
284TSTFCA6003	GT1227	✓	65	284TTFNA6527	E675	✓	69	286TTDCA6037	GT2431	✓	140	315STFC6588	R508	✓	95
284TSTFCA6005	GT1127	✓	62	284TTFNA6576	E638	✓	68	286TTDCA6038	GT2531	✓	140	324THFPA8028	Y571	✓	88
284TSTFNA6001	E222	✓	58	284TTFNA6580	E694	✓	68	286TTDCA6076	GT0026	✓	45	324THFPA8038	Y513	✓	88
284TSTFNA6501	E607	✓	69	284TTFNA6837	E488	✓	69	286TTDN14101	H189A		38	324THFPA8086	Y583		88
284TSTFNA6502	E660		69	284TTFNA6876	E483	✓	68	286TTDP4015	U114		128	324THFS9026	W573	✓	73
284TSTFPA4005	U654		50	284TTFNA7240	Y385	✓	184	286TTDP4020	U236		138	324THFS9076	W562	✓	72
284TSTGN6503	E546		80	284TTFNA7508	M896		153	286TTDP4021	U115		128	324THFS9080	W563		72
284TSTGN16531	U076A		80	284TTFNA14102	L414A	✓	49	286TTDP4024	U237		138	324THFS19033	W574		73
284TTDC6026	U771	✓	43	284TTFNA16065	E207-P	✓	58	286TTDP4027	E911	✓	39	324THFS19058	W573-P	✓	73
284TTDC6029	E762A	✓	43	284TTFNA16832	U873A	✓	66	286TTDP4034	E763		39	324TSHFS9001	W571	✓	73
284TTDC6076	U256	✓	43	284TTFNA16851	E622-P	✓	69	286TTDP4037	U112		128	324TSTDC6001	U776	✓	44
284TTDC6079	U288	✓	43	284TTFPA4028	U655		50	286TTDP4041	U506		144	324TSTDC6003	U294	✓	44
284TTDCA6007	GT0430	✓	130	284TTFPA4030	E800		50	286TTDP4047	U113		128	324TSTDC6001	GT0036	✓	45
284TTDCA6008	GT0530	✓	130	284TTFPA14048	M897A		153	286TTDP4048	U233		138	324TSTDP4006	U909		38
284TTDCA6012	GT2430	✓	140	284TTFPA14049	M890A		153	286TTDP4049	U235		138	324TSTDP4007	U513		144
284TTDCA6013	GT2530	✓	140	284TTGN6533	E547	✓	80	286TTDP4067	U111		128	324TSTDP4010	U512	✓	144
284TTDCA6026	GT0028	✓	45	284TTGN6576	E504	✓	80	286TTDP4074	U234		138	324TSTDP4016	U445	✓	41
284TTDCA6032	GT0428	✓	130	284TTGN16539	U029A	✓	80	286TTDP7217	Y460		185	324TSTDP16002	U445A	✓	41
284TTDCA6033	GT0528	✓	130	284TTGN16550	E547-P	✓	80	286TTDP7251	Y473		185	324TSTDP16032	U444A		41
284TTDCA6037	GT2428	✓	140	284TTGP4030	U029		78	286TTDP7689	Y216	✓	188	324TSTFC6002	E971A	✓	59
284TTDCA6038	GT2528	✓	140	284TTTNA16577	S519		187	286TTDP14042	U507		144	324TSTFC6006	E011	✓	59
284TTDCA6076	GT0023	✓	45	284TTTNA17101	S567	✓	187	286TTDR14042	M826A		149	324TSTFC6036	E816A	✓	59
284TTDN14102	H188A		38	284TTTNA18577	S569		187	286TTDR14046	M822A		149	324TSTFCA6001	GT1033	✓	62
284TTDP4011	U230		138	284TTTNA18601	S517		187	286TTDR14081	M819A		149	324TSTFCA6003	GT1233	✓	65
284TTDP4012	U232		138	286THFNA8028	Y570	✓	88	286TTDR16037	E1009	✓	43	324TSTFCA6005	GT1133	✓	62
284TTDP4022	U231		138	286THFNA9026	W567	✓	72	286TTDR16038	E1009-P	✓	43	324TSTFCA6001	E224	✓	59
284TTDP4023	U110		128	286THFNA9076	W555	✓	72	286TTDR17009	M829		149	324TSTFCA6005	E319		59
284TTDP4025	U108		128	286THFNA19033	W568		72	286TTFC6027	E983B	✓	58	324TSTFCA6001	E609	✓	69
284TTDP4027	U502		144	286THFNA19066	W567-P	✓	72	286TTFC6031	E817A	✓	59	324TSTFCA6005	E662		69
284TTDP4029	E910		38	286THFNA19077	W556		72	286TTFC6077	E968A	✓	58	324TSTFCA6001	E566		80
284TTDP4035	E762		38	286THFNA19101	W550	✓	72	286TTFC6081	E008	✓	58	324TSTFCA6001	U078A		80
284TTDP4037	U107		128	286THFPA8038	Y512	✓	88	286TTFC6006	GT3130	✓	134	324TSTFCA6001	U775	✓	43
284TTDP4043	U105		128	286THFPA8086	Y582		88	286TTFC6008	GT3230	✓	134	324TTDC6029	E764A	✓	44
284TTDP4044	U227		138	286THTNA7026	Y393	✓	86	286TTFC6012	GT3430	✓	142	324TTDC6076	U798	✓	43
284TTDP4045	U229		138	286THTNA7036	Y394	✓	86	286TTFC6013	GT3530	✓	142	324TTDCA6007	GT0436	✓	130
284TTDP4047	U503		144	286TPFSA10090	SY013	✓	91	286TTFC6026	GT1031	✓	62	324TTDCA6008	GT0536	✓	130
284TTDP4069	U106		128	286TSHFNA9001	W565	✓	72	286TTFC6028	GT1231	✓	65	324TTDCA6012	GT2436	✓	140
284TTDP7202	Y493		185	286TSTDC6001	U774	✓	44	286TTFC6030	GT1131	✓	62	324TTDCA6013	GT2536	✓	140
284TTDP7205	Y472		185	286TSTDC6003	U293	✓	44	286TTFC6032	GT3131	✓	134	324TTDCA6026	GT0034	✓	45
284TTDP7221	Y459	✓	185	286TSTDC6001	GT0033	✓	45	286TTFC6033	GT3231	✓	134	324TTDCA6032	GT0434	✓	130
284TTDP7692	Y215	✓	188	286TSTDN16004	U443A	✓	41	286TTFC6037	GT3431	✓	142	324TTDCA6033	GT0534	✓	130
284TTDP14009	U109A	✓	128	286TSTDN16005	U441A	✓	41	286TTFC6038	GT3531	✓	142	324TTDCA6037	GT2434	✓	140
284TTDP14044	U228A	✓	138	286TSTDN16033	U442A		41	286TTFC6076	GT1026	✓	62	324TTDCA6038	GT2534	✓	140
284TTDR14011	M825A		149	286TSTDN16034	U440A		41	286TTFC6080	GT1126	✓	62	324TTDCA6076	GT0029	✓	45
284TTDR14082	M815A		149	286TSTDP4017	U902		39	286TTFNA6026	E208	✓	58	324TTDP4002	U240		138
284TTDR16047	E1006	✓	43	286TSTDP4022	U508	✓	144	286TTFNA6030	E310	✓	58	324TTDP4004	U118		128
284TTDR16048	E1006-P	✓	43	286TSTDP4023	U509		144	286TTFNA6076	E238	✓	58	324TTDP4011	U241		138
284TTDR16077	E1002	✓	43	286TSTDR16002	E1010	✓	43	286TTFNA6526	E623	✓	69	324TTDP4018	U119		128
284TTFCA6027	E961C	✓	58	286TSTFC6036	E818A	✓	58	286TTFNA6527	E676	✓	69	324TTDP4028	E764		39
284TTFCA6031	E800A	✓	58	286TSTFCA6001	GT1030	✓	62	286TTFNA6570	E491	✓	69	324TTDP4030	E787		39

# Index

## Model Number/Catalog Number

MODEL NO.	CAT. NO.	STOCK	PAGE NO.	MODEL NO.	CAT. NO.	STOCK	PAGE NO.	MODEL NO.	CAT. NO.	STOCK	PAGE NO.	MODEL NO.	CAT. NO.	STOCK	PAGE NO.
324TTDP4033	U239		138	326TSTDR14034	U521		144	326TTFS14087	M902A		153	364TTFS14087	M906A		153
324TTDP4038	U510		144	326TSTDR16034	E791A	✓	43	326TTFS16068	E210-P	✓	59	364TTFS16083	E241A	✓	59
324TTDP4345	U116		128	326TSTDR16035	U446A		41	326TTFS16574	U876A	✓	66	364TTFS16558	U877A	✓	66
324TTDP4348	U238		138	326STFC6002	E976A	✓	59	326TTFS16844	E625-P	✓	69	364TTFS16584	E642A	✓	69
324TTDP4349	U117		128	326STFC6006	E013	✓	59	326TTGP4030	U032		78	364TTFS16585	E401A		69
324TTDP7687	Y217	✓	188	326STFC6036	E801A	✓	59	326TTGS6532	E570	✓	80	364TTGS4040	U033		78
324TTDP14049	U511		144	326STFCA6001	GT1036	✓	62	326TTGS6578	E565	✓	80	364TTGS16536	E573A	✓	80
324TTDR14010	M833A		149	326STFCA6003	GT1236	✓	65	326TTGS16539	U032A		80	364TTGS16537	U033A		80
324TTDR14049	M830A		149	326STFCA6005	GT1136	✓	62	326TTGS16546	E570-P	✓	80	364TTGS16577	E568A	✓	80
324TTDR14080	M823A		149	326STFS6001	E225	✓	59	326TTTS18577	S528		187	365THFS8036	Y574	✓	88
324TTDR14104	M820A		149	326STFS6005	E320		59	364THFS8036	Y573	✓	88	365THFS8046	Y516	✓	88
324TTDR16050	U755-P	✓	44	326STFS6501	E610	✓	69	364THFS8046	Y515	✓	88	365THFS8380	Y586		88
324TTFC6027	E984B	✓	59	326STFS6502	E663		69	364THFS8391	Y585		88	365THFS9036	W594	✓	73
324TTFC6031	E815A	✓	59	326STFS6536	E453		69	364THFS9036	W587	✓	73	365THFS9044	W595	✓	73
324TTFCA6007	GT3133	✓	134	326STGS6501	E569		80	364THFS19033	W588		73	365THFS19065	W594-P	✓	73
324TTFCA6008	GT3233	✓	134	326STGS16532	U079A		80	364THFS19061	W587-P	✓	73	365THFS19077	W640		73
324TTFCA6012	GT3433	✓	142	326TTDC6026	U777	✓	44	364THFS19077	W639		73	365THFS19086	W582A	✓	73
324TTFCA6013	GT3533	✓	142	326TTDC6029	E765A		44	364THFS19087	W575A	✓	73	365THFS19101	W576		73
324TTFCA6026	GT1034	✓	62	326TTDC6076	U799	✓	43	364TSHFS9001	W584	✓	73	365TSHFS9001	W591	✓	73
324TTFCA6028	GT1234	✓	65	326TTDCA6026	GT0037	✓	45	364TSHFS9026	W586		73	365TSHFS19002	W592		73
324TTFCA6030	GT1134	✓	62	326TTDCA6032	GT0437	✓	130	364TSTDCA6001	U1782	✓	44	365TSHFS19034	W593A		73
324TTFCA6032	GT3134	✓	134	326TTDCA6033	GT0537	✓	130	364TSTDCB6001	GT0042	✓	46	365TSTDC6001	U1784	✓	44
324TTFCA6033	GT3234	✓	134	326TTDCA6037	GT2437	✓	140	364TSTDS4024	U523		145	365TSTDCB6001	GT0045	✓	46
324TTFCA6037	GT3434	✓	142	326TTDCA6038	GT2537	✓	140	364TSTDS4025	U522	✓	145	365TSTDC4025	U526	✓	145
324TTFCA6038	GT3534	✓	142	326TTDCA6076	GT0032	✓	45	364TSTDS4332	U518	✓	144	365TSTDS4303	U527	✓	145
324TTFCA6076	GT1029	✓	62	326TTDP4032	U243		138	364TSTDS4337	U519		144	365TSTDS4332	U524	✓	145
324TTFCA6080	GT1129	✓	62	326TTDP4046	E790		39	364TSTFC6002	E960A	✓	59	365TSTDS4347	U525		145
324TTFPA4030	E815		50	326TTDP4048	E765	✓	39	364TSTFC6006	E015	✓	59	365TSTDS6074	U450A		41
324TTFPA14065	M905A		153	326TTDP4326	U121		128	364TSTFC6026	E802A	✓	59	365TSTDS16005	U451A		41
324TTFPA14089	M898A		153	326TTDP4329	U120		128	364TSTFCA6001	GT1039	✓	62	365TSTDS16008	U449A		41
324TTFS6026	E209	✓	59	326TTDP4340	U242		138	364TSTFCA6003	GT1239	✓	65	365TSTDS16041	E782C	✓	44
324TTFS6030	E311	✓	59	326TTDP4344	U515		144	364TSTFCA6005	GT1139	✓	62	365TSTDS16042	E768C	✓	44
324TTFS6076	E239	✓	58	326TTDP4345	U514		144	364TSTFS6001	E226	✓	59	365TSTDS16044	U448A		41
324TTFS6526	E624	✓	69	326TTDP7697	Y218	✓	188	364TSTFS6005	E321	✓	59	365TSTFC6003	E991A	✓	59
324TTFS6527	E677	✓	69	326TTDR14010	M837A		150	364TSTFS6501	E611	✓	69	365TSTFC6006	E016	✓	59
324TTFS6576	E640	✓	69	326TTDR14034	M834A		149	364TSTFS6505	E664		69	365TSTFC6026	E804A	✓	59
324TTFS6577	E696		69	326TTDR14103	M824A		149	364TSTFS6526	E454		69	365TSTFCA6001	GT1042	✓	62
324TTFS7290	Y387	✓	184	326TTDR14105	H191A		38	364TSTGS6506	E572		80	365TSTFCA6002	GT1142	✓	62
324TTFS14003	M904A		153	326TTDR16063	E791A-P	✓	44	364TSTGS16531	U080A		80	365TSTFCA6003	GT1242	✓	65
324TTFS14101	L416A	✓	50	326TTFC6027	E962B	✓	59	364TSTDC6060	U1779	✓	44	365TSTFS6001	E227	✓	59
324TTFS16062	E209-P	✓	59	326TTFC6031	U659A	✓	59	364TTDCA6086	U1927	✓	44	365TSTFS6002	E322		59
324TTFS16837	U875A	✓	66	326TTFC6077	E966A	✓	59	364TTDCB6060	GT0040	✓	45	365TSTFS6501	E612	✓	69
324TTFS16860	E624-P	✓	69	326TTFC6081	E010	✓	59	364TTDCB6086	GT0035	✓	45	365TSTFS6502	E665	✓	69
324TTGP4030	U031		78	326TTFCA6007	GT3136	✓	134	364TTDR14032	M838A		150	365TSTFS6526	E455	✓	69
324TTGS6529	E567	✓	80	326TTFCA6008	GT3236	✓	134	364TTDS4040	E766		39	365TSTFS16503	E575		81
324TTGS16535	U031A		80	326TTFCA6012	GT3436	✓	142	364TTDS4328	U520		144	365TSTGS16532	U081A		81
324TTGS16541	E567-P	✓	80	326TTFCA6013	GT3536	✓	142	364TTDS14011	M841A		150	365TTDCA6060	U1783	✓	44
324TTGS16577	U048A	✓	80	326TTFCA6026	GT1037	✓	62	364TTDS14081	M831A		149	365TTDCA6086	U1928	✓	44
324TTTS18577	S525		187	326TTFCA6028	GT1237	✓	65	364TTDS14104	M828A		149	365TTDCB6060	GT0043	✓	46
324TTTS18601	S523		187	326TTFCA6030	GT1137	✓	62	364TTDS14329	U538		144	365TTDCB6086	GT0038	✓	45
326THFA8038	Y514	✓	88	326TTFCA6032	GT3137	✓	134	364TTFC6037	E985B	✓	59	365TTDS4041	E767		39
326THFA8086	Y584		88	326TTFCA6033	GT3237	✓	134	364TTFC6041	U660A	✓	59	365TTDS4328	M842A		150
326THFS8028	Y572	✓	88	326TTFCA6037	GT3437	✓	142	364TTFC6081	E012	✓	59	365TTDS7383	Y209		188
326THFS9026	W580	✓	73	326TTFCA6038	GT3537	✓	142	364TTFC6087	E988A	✓	59	365TTDS14009	M845A		150
326THFS9076	W569	✓	72	326TTFCA6076	GT1032	✓	62	364TTFCA6036	GT1040	✓	62	365TTDS14082	M835A		149
326THFS19033	W581		73	326TTFCA6080	GT1132	✓	62	364TTFCA6038	GT1240	✓	65	365TTDS14101	M832A		149
326THFS19071	W580-P	✓	73	326TTFPA4030	U659		50	364TTFCA6040	GT1140	✓	62	365TTDS16064	E767A		44
326THFS19078	W643		72	326TTFPA14049	M909A		153	364TTFCA6080	GT1135	✓	62	365TTDS16067	E766A		44
326TSHFS9001	W577		73	326TTFS6026	E210	✓	59	364TTFCA6086	GT1035	✓	62	365TTDS16072	M742		150
326TSHFS9005	W578		73	326TTFS6030	E312	✓	59	364TTFS4040	U660		50	365TSTFC6037	E957A	✓	59
326TSHFS9036	W579		73	326TTFS6076	E240	✓	59	364TTFS6036	E211	✓	59	365TSTFC6041	E805A	✓	59
326TSTDC6001	U778	✓	43	326TTFS6526	E625	✓	69	364TTFS6040	E313	✓	59	365TSTFC6081	E014	✓	59
326TSTDC6001	GT0039	✓	45	326TTFS6527	E678	✓	69	364TTFS6536	E626	✓	69	365TSTFC6087	E993A	✓	59
326TSTDP4003	U910		39	326TTFS6576	E641	✓	69	364TTFS6537	E679	✓	69	365TTFCA6036	GT1043	✓	62
326TSTDP4022	U517		144	326TTFS6580	E400		69	364TTFS8101	L420	✓	50	365TTFCA6038	GT1243	✓	65
326TSTDP4024	U516	✓	144	326TTFS9210	Y388	✓	184	364TTFS9234	Y389	✓	184	365TTFCA6040	GT1143	✓	62
326TSTDP16005	U447A		41	326TTFS14101	L417A	✓	50	364TTFS14003	M912A		154	365TTFCA6080	GT1138	✓	62
326TSTDP16032	E789A	✓	44	326TTFS14103	M899A		153	364TTFS14058	M913A		154	365TTFCA6086	GT1038	✓	62



## Model Number/Catalog Number

MODEL NO.	CAT. NO.	STOCK	PAGE NO.	MODEL NO.	CAT. NO.	STOCK	PAGE NO.	MODEL NO.	CAT. NO.	STOCK	PAGE NO.	MODEL NO.	CAT. NO.	STOCK	PAGE NO.
365TTFS4040	E805		50	405STFC6001	GT1045	✓	63	444TSTGN16502	U073A		81	445TSTFN6526	E458	✓	70
365TTFS7923	M916A		154	405STFC6003	GT1245	✓	65	444TSTGN16531	U083A		81	445TSTFN6528	E459	✓	70
365TTFS6036	E212	✓	59	405STFC6005	GT1145	✓	63	444TDC16077	GT0047	✓	46	445TSTFN16004	E342	✓	60
365TTFS6040	E315	✓	59	405STFS6001	E228	✓	59	444TDC6060	GT0052	✓	46	445TSTFN16033	E813A		60
365TTFS6536	E627	✓	69	405STFS6005	E323	✓	59	444TTDS14003	M857A		150	445TSTGN16505	E584		81
365TTFS6537	E680		69	405STFS6501	E613	✓	70	444TTDS14057	M854A		150	445TSTGN16506	U075A		81
365TTFS8115	L425	✓	50	405STFS6502	E493		70	444TTDS14086	M847A		150	445TSTGN16531	U084A		81
365TTFS9230	Y390	✓	184	405STFS6526	E456	✓	70	444TTDS14101	M844A		150	445TDC6060	GT0055	✓	46
365TTFS14060	M917A		154	405STFS16033	E808A	✓	59	444TTDS16043	U911A		44	445TDC16076	GT0050	✓	46
365TTFS14084	M910A		153	405STGS6503	E578		81	444TTDS16077	U272	✓	44	445TDS4037	E745		39
365TTFS16083	E242A	✓	59	405STGS16531	U082A		81	444TTDS4069	U911		39	445TDS4070	U912		39
365TTFS16591	E643A	✓	69	405TDC6060	GT0049	✓	46	444TDS6060	E924	✓	44	445TDS6060	E925	✓	44
365TTFS16592	E402A		69	405TDC16081	GT0044	✓	46	444TDS8699	Y212	✓	188	445TDS7121	M848		150
365TTFS16827	U878A	✓	66	405TTDS4049	U904		39	444TFC6036	GT1049	✓	63	445TDS9477	Y213		188
365TTFS17102	M907		153	405TTDS4376	M843A		150	444TFC6044	GT1149	✓	63	445TDS17084	M855A		150
365TTGS4040	U034		78	405TDS6060	E923	✓	44	444TFC6080	GT1147	✓	63	445TDS14003	M861A		150
365TTGS16540	E576A	✓	81	405TDS7124	M840		150	444TFC6086	GT1047	✓	63	445TDS14062	M862A		150
365TTGS16542	U034A		81	405TDS7697	Y211		188	444TFN6044	E316A		60	445TDS14063	M858A		150
365TTGS16577	E571		80	405TTDS14003	M853A		150	444TFN6086	E328	✓	59	445TDS14087	M851A		150
404THFS8092	Y587		88	405TTDS14067	M850A		150	444TFN14044	M925A		154	445TDS16041	U912A		44
404THFS9086	W589		73	405TTDS16060	U904A		44	444TFN14080	M922A		154	445TDS16076	U273	✓	44
404THFS9101	W583		73	405TTDS16070	M750		150	444TFN16549	U880A	✓	66	445TFC6036	GT1052	✓	63
404TSDC6001	GT0048	✓	46	405TTDS16081	U271	✓	44	444TFN16581	E646A	✓	70	445TFC6037	GT1152	✓	63
404TSDS4017	U530	✓	145	405TFC6036	GT1046	✓	63	444TFN16582	E405A		70	445TFC6080	GT1150	✓	63
404TSDS4332	U528	✓	145	405TFC6038	GT1246	✓	65	444TFN16577	E327		70	445TFC6086	GT1050	✓	63
404TSDS4333	U529	✓	145	405TFC6040	GT1146	✓	63	444TFS6036	E214	✓	60	445TFN4575	U884		66
404TSDS6001	U250	✓	44	405TFC6080	GT1144	✓	62	444TFS6536	E629	✓	70	445TFN6028	U669A		60
404TSDS6327	U452A		41	405TFC6086	GT1044	✓	62	444TFS6540	E697		70	445TFN6036	E215	✓	60
404TSDS14008	U531		145	405TFS6036	E213	✓	59	444TFS7321	M924		154	445TFN6037	E317		60
404TSDS16006	U453A	✓	41	405TFS6040	E314	✓	59	444TFS7262	Y392		184	445TFN6038	E247	✓	60
404TSDS16036	E780A	✓	44	405TFS6086	E244	✓	59	444TFS7403	M919		154	445TFN6039	E326		60
404TDC6060	GT0046	✓	46	405TFS6536	E628	✓	70	444TFS8106	L428		50	445TFN6040	E287		60
404TDC6086	GT0041	✓	45	405TFS6538	E681	✓	70	444TGN16532	E582A	✓	81	445TFN6086	E246	✓	60
404TDS4042	U903		39	405TFS6586	E645	✓	69	444TGN16533	U036A		81	445TFN6087	E289		60
404TDS4359	M846A		150	405TFS6587	E404		69	444TGN16580	E580A	✓	81	445TFN6536	E630	✓	70
404TDS6060	E922	✓	44	405TFS7297	Y391		184	444TGS4042	U036		78	445TFN6537	E682		70
404TDS6086	U270	✓	44	405TFS7612	M920		154	445TFN8036	Y577	✓	89	445TFN6538	E631	✓	70
404TDS7387	Y210	✓	188	405TFS8114	L427	✓	50	445TFN8040	Y578	✓	89	445TFN6540	E450		70
404TTDS14005	M849A		150	405TFS14063	M921A		154	445TFN8046	Y519	✓	89	445TFN6586	E647	✓	70
404TTDS14081	M839A		150	405TFS14087	M918A		154	445TFN8050	Y520	✓	89	445TFN6587	E448	✓	70
404TTDS14102	M836A		149	405TFS16834	U879A	✓	66	445TFN9036	W612	✓	73	445TFN6590	E406		70
404TTDS16055	U903A		44	405TGS4040	U035		78	445TFN9037	W613		73	445TFN6591	E407		70
404TFC6080	GT1141	✓	62	405TGS6548	E594	✓	81	445TFN9038	W618		74	445TFN8040	L452	✓	50
404TFC6086	GT1041	✓	62	405TGS6589	E577		81	445TFN9086	W608		73	445TFN8041	L453		50
404TFS6086	E243	✓	59	405TGS16539	U035A		81	445TFN9087	W614		73	445TFN8102	L440		50
404TFS6586	E644	✓	69	444TFN8036	Y576	✓	89	445TFN9102	W609		73	445TFN8115	L429	✓	50
404TFS6592	E403		69	444TFN8046	Y518	✓	89	445TFN9106	W603		73	445TFN14003	M928A		154
404TFS8102	L426	✓	50	444TFN8384	Y589	✓	89	445TFN19033	W641		73	445TFN14086	M926A		154
404TFS14088	M914A		154	444TFN19044	W606-P	✓	73	445TFN19034	W642	✓	74	445TFN14326	M929A		154
404TGS6588	E574		80	444TFN19081	W636		73	445TFN19070	W618-P	✓	74	445TFN14330	M933A		154
405THFS8036	Y575	✓	89	444THFS9036	W606		73	445TFN19071	W612-P	✓	73	445TFN16852	U882A		66
405THFS8046	Y517	✓	89	444THFS9040	W607		73	445SHFN9001	W610		73	445TFN16866	U881A	✓	66
405THFS8378	Y588	✓	88	444THFS9101	W597		73	445SHFN9005	W616		74	445TGN4030	U037		78
405THFS9036	W600	✓	73	444SHFN19002	W604A		73	445SHFN9026	W611	✓	73	445TGN4045	U038		78
405THFS9040	W601	✓	73	444TSDC16003	GT0054	✓	46	445SHFN9028	W617		74	445TGN6538	E588		81
405THFS9086	W596		73	444TSDS4010	U536	✓	145	445TSDS4001	E757	✓	39	445TGN6542	E585		81
405THFS19101	W590		73	444TSDS4332	U535	✓	145	445TSDS4332	U537	✓	145	445TGN6597	E583		81
405THFS19327	W600-P	✓	73	444TSDS16034	U456A		41	445TSDS14007	U539	✓	145	445TGN16543	U038A		81
405THFS9001	W598	✓	73	444TSDS16038	E792A	✓	44	445TSDS14051	U540	✓	145	445TGN16544	U037A		81
405THFS9026	W599		73	444TSDS16003	U252	✓	44	445TSDS16038	U400A	✓	44	445TGN16588	U090A	✓	81
405TSDC6007	GT0051	✓	46	444TSTFC6001	GT1048	✓	63	445TSTFC6001	GT1051	✓	63	447TSDN7001	H178	✓	39,145
405TSDS4006	U534	✓	145	444TSTFC16002	GT1148	✓	63	445TSTFC6005	GT1151	✓	63	447TSDN7003	H193	✓	39,145
405TSDS4332	U532	✓	145	444TSTFN16033	E810A	✓	60	445TSTFN6001	E230	✓	60	447TSDN7005	H817	✓	39,145
405TSDS4333	U533		145	444TSTFS6001	E229	✓	60	445TSTFN6026	E811A	✓	60	447TSDN7026	H812	✓	39,145
405TSDS6007	U251	✓	44	444TSTFS6501	E614	✓	70	445TSTFN6501	E615	✓	70	447TSDN7027	H813	✓	39,145
405TSDS16005	U455A		41	444TSTFS6505	E494		70	445TSTFN6502	E495		70	447TSDN7028	H814	✓	39,145
405TSDS16038	E781A	✓	44	444TSTFS6526	E457	✓	70	445TSTFN6505	E449	✓	70	447TSDN16004	U785	✓	44
405TSDS16039	U454A		41	444TSTFS16002	E324		60	445TSTFN6506	E496		70	447TSDN16007	U788	✓	44

# Index

## Model Number/Catalog Number

MODEL NO.	CAT. NO.	STOCK	PAGE NO.	MODEL NO.	CAT. NO.	STOCK	PAGE NO.	MODEL NO.	CAT. NO.	STOCK	PAGE NO.	MODEL NO.	CAT. NO.	STOCK	PAGE NO.
447TSTDN16008	U791	✓	44	449TTFS6582	E408		70	KIT 105	A105	✓	213	KIT 250TCDX	A612	✓	205
447TSTFC6005	GT1154	✓	63	449TTFS6587	E688		70	KIT 106	A106	✓	213	KIT 250TCF-WD	A173		206
447TSTFC16004	GT1054	✓	63	449TTFS6588	E687	✓	70	KIT 107-637	A107	✓	210	KIT 250TCF2-WD	A172		206
447TTDC16077	GT0053	✓	46	449TTFS7109	M931		154	KIT 109	A109	✓	218	KIT 250TCFL	A209	✓	206
447TTDN14087	H822A		39	449TTFS8027	L463	✓	50	KIT 110	A110	✓	211	KIT 250TCFL-R	A1209	✓	206
447TTDN16041	U789		44	449TTFS8028	L455		50	KIT 111	A111	✓	212	KIT 250TCFNA	A284	✓	206
447TTDN16046	U786	✓	44	449TTFS8036	L467	✓	50	KIT 112	A112	✓	211	KIT 250TCFNA-841	A184	✓	207
447TTDN16077	U274	✓	44	449TTFS8037	L462	✓	50	KIT 113	A113	✓	211	KIT 250TCFP	A601	✓	206
447TTFC6038	GT1055	✓	63	449TTFS8038	L454	✓	50	KIT 114	A114	✓	211	KIT 250TCFPA	A239	✓	206
447TTFC6039	GT1155	✓	63	449TTFS8076	L465		50	KIT 116	A116	✓	218	KIT 250DFNA	A648	✓	207
447TTFC6080	GT1153	✓	63	449TTFS8077	L457		50	KIT 140CB	A715	✓	216	KIT 250DFPA	A647	✓	207
447TTFC6087	GT1053	✓	63	449TTFS8086	L464	✓	50	KIT 140TCDR-1	A436	✓	205	KIT 250U	25U21T	✓	219
449THFS8036	Y579	✓	89	449TTFS8087	L456	✓	50	KIT 140TCFR-1	A438	✓	206	KIT 251	A251	✓	211
449THFS8037	Y580	✓	89	449TTFS8110	L449	✓	50	KIT 143SB	143A	✓	219	KIT 252	A252	✓	211
449THFS8046	Y531	✓	89	449TTFS8111	L442		50	KIT 143TCFN	A603	✓	206	KIT 253	A253	✓	211
449THFS8047	Y532	✓	89	449TTFS14043	L469A	✓	50	KIT 143TCTN-841	A181	✓	207	KIT 254	A254	✓	211
449THFS8048	Y533	✓	89	449TTFS16094	E814A		60	KIT 145SB	145A	✓	219	KIT 254SB	254B2	✓	219
449THFS9027	W632		74	449TTFS16333	E293		60	KIT 145TCFN	A655	✓	206	KIT 256	A256	✓	213
449THFS9028	W626		74	449TTFS16334	E291		60	KIT 145TCTN-841	A262	✓	207	KIT 256SB	256B2	✓	219
449THFS9030	W619		74	449TTFS16534	E345		70	KIT 180/210CB	A720	✓	214	KIT 257	A257	✓	213
449THFS9036	W635		74	449TTFS16553	E776		70	KIT 180-190 TERM BLK	A1000	✓	208	KIT 258	A258	✓	213
449THFS9088	W622		74	449TTFS18105	L471		50	KIT 180CF4.5-1	A645	✓	206	KIT 259	A259	✓	212
449THFS9101	W615		73	449TTGS7036	H504	✓	81	KIT 180CF8.5-1	A644	✓	206	KIT 261	A261	✓	214
449THFS19079	W630		74	449TTGS7037	H503		81	KIT 180R	A718	✓	216	KIT 277	A277	✓	212
449THFS19092	W621		74	449TTGS7068	H502		81	KIT 180TCD-WD	A160		205	KIT 278	A278	✓	212
449THFS19342	W626-P	✓	74	449TTGS16537	E591		81	KIT 180TCF-WD	A170		206	KIT 279	A279	✓	210
449TSHFS9001	W634		74	449TTGS16585	U091A		81	KIT 180TCN4.5	A640	✓	206	KIT 280	A280	✓	210
449TSHFS9003	W624		74	505UTDS805	M852		150	KIT 180TCN8.5	A641	✓	206	KIT 280CB	A729	✓	214
449TSTDN7001	H818	✓	39,145	505UTDS819	M856		150	KIT 180TCFS-841	A182	✓	207	KIT 280R	A728	✓	216
449TSTDN7027	H816		39,145	505UTDS1584	Y219		188	KIT 180TDFR	A630	✓	207	KIT 280RFN	A727	✓	216
449TSTDN14005	H819A	✓	39,145	505UTDS1590	Y220		188	KIT 180U	1814T	✓	219	KIT 280RFNA	A731	✓	216
449TSTDN14033	H815A		39,145	505UTDS3999	M863A		150	KIT 182SB	182A	✓	219	KIT 280RFP	A726	✓	216
449TSTDN16003	U793	✓	44	505UTDS5820	M860		150	KIT 184SB	184A	✓	219	KIT 280TCD-WD	A165		205
449TSTDN16004	U795	✓	44	505UTDS14077	M859A		150	KIT 197	A197	✓	214	KIT 280TCD2-WD	A164		205
449TSTDN16005	U797	✓	44	5011LSTFS16031	E364		70	KIT 198	A198	✓	214	KIT 280TCD	A287	✓	205
449TSTGS14003	E595		81	5011LSTFS16033	E366		70	KIT 199	A199	✓	214	KIT 280TCDCA	A1287	✓	205
449TSTFS6001	E273		60	5013LSTFS6595	E363		70	KIT 202	A202	✓	214	KIT 280TCDP	A610	✓	205
449TSTFS6002	E272		60	976B399AAP9	A950	✓	215	KIT 201	A201	✓	214	KIT 280TCF-WD	A175		206
449TSTFS6003	E271		60	976B399AAP12	A951	✓	215	KIT 190TCDW	A606	✓	205	KIT 280TCF2-WD	A174		206
449TSTFS6501	E769	✓	70	976B399AAP13	A952	✓	215	KIT 190TCD-WD	A161		205	KIT 280TCFN	A615	✓	206
449TSTFS6502	E698	✓	70	976B399ABP6	A953	✓	215	KIT 190TCFL	A204	✓	206	KIT 280TCFN-841	A185	✓	207
449TSTFS6503	E699	✓	70	976B399ABP9	A954	✓	215	KIT 190TCF5	A206	✓	206	KIT 280TCFNA	A618	✓	206
449TSTFS8001	L466	✓	50	976B399ABP10	A955	✓	215	KIT 190TCF5-841	A183	✓	207	KIT 280TCFNA-841	A186	✓	207
449TSTFS8002	L459	✓	50	KIT 391-200-01	A000	✓	215	KIT 190TCFW	A609	✓	206	KIT 280TCFP	A611	✓	206
449TSTFS14007	L451A	✓	50	KIT 391-200-02	A001	✓	215	KIT 190TCF-WD	A171		206	KIT 280TCFPA	A617	✓	206
449TTDC16076	GT0056		46	KIT 3BRK1	A306	✓	209	KIT 190TCN	A646	✓	206	KIT 280DFNA	A656	✓	207
449TTDN7086	H820		39	KIT 3BRK3	A301	✓	209	KIT 190R	A721	✓	216	KIT 280TDFP	A631	✓	207
449TTDN14078	H821A		39	KIT 3BRK3A	A297	✓	209	KIT 190U	1918T	✓	219	KIT 280U	28U25T	✓	219
449TTDN16076	U275	✓	44	KIT 6BRK1	A307	✓	209	KIT 193SB	193A	✓	219	KIT 281	A281	✓	210
449TTDN16077	U790		44	KIT 6BRK3	A302	✓	209	KIT 195SB	195A	✓	219	KIT 282	A282	✓	210
449TTC6080	GT1156		63	KIT 6BRK3A	A298	✓	209	KIT 234	A234	✓	214	KIT 283	A283	✓	210
449TTC6088	GT1056		63	KIT 10BRK	A303	✓	209	KIT 240	A240	✓	210	KIT 284SB	284B2	✓	219
449TTF6037	E277		60	KIT 10BRKA	A299	✓	209	KIT 241	A241	✓	210	KIT 286SB	286B2	✓	219
449TTF6038	E276		60	KIT 21TEBC	A692	✓	216	KIT 242	A242	✓	210	KIT 308	A308	✓	210
449TTF6065	E292		60	KIT 25TEBCNA	A691	✓	216	KIT 243	A243	✓	212	KIT 311	A311	✓	214
449TTF6087	E283		60	KIT 28TEBCNA	A701	✓	216	KIT 244	A244	✓	212	KIT 320CB	A730	✓	214
449TTF6088	E282	✓	60	KIT 32TEBC	A695	✓	216	KIT 245	A245	✓	212	KIT 320RFP	A733	✓	216
449TTF6390	E284		60	KIT 36TEBC	A696	✓	216	KIT 247	A247	✓	214	KIT 320TCD-WD	A167		205
449TTF6527	E772		70	KIT 40TEBC	A697	✓	216	KIT 248	A248	✓	214	KIT 320TCD2-WD	A166		205
449TTF6528	E771	✓	70	KIT 44TEBC-313	A698	✓	216	KIT 249	A249	✓	211	KIT 320TCDP	A613	✓	205
449TTF6530	E770	✓	70	KIT 44TEBC-316	A699	✓	216	KIT 250	A250	✓	211	KIT 320TCF-WD	A177		206
449TTF6536	E692	✓	70	KIT 44TEBC-318	A700	✓	216	KIT 250-320 TERM BLK	A1001	✓	208	KIT 320TCF2-WD	A176		206
449TTF6537	E691	✓	70	KIT 56CDR-1	A435	✓	205	KIT 250CB	A722	✓	214	KIT 320TCFP	A614	✓	206
449TTF6538	E690	✓	70	KIT 56CFR-1	A437	✓	206	KIT 250R	A725	✓	216	KIT 320TCFPA	A619	✓	206
449TTF6540	E854	✓	70	KIT 56 EXPR BOX	A800	✓	214	KIT 250RFNA	A724	✓	216	KIT 320TCFS	A194	✓	206
449TTF6564	E856	✓	70	KIT 100	A100	✓	212	KIT 250RFP	A723	✓	216	KIT 320TCFS-841	A187	✓	207
449TTF6577	E774		70	KIT 103	A103	✓	218	KIT 250TCD-WD	A163		205	KIT 320TDFP	A632	✓	207
449TTF6578	E773	✓	70	KIT 104	A104	✓	211	KIT 250TCD2-WD	A162		205	KIT 320TDFPA	A657	✓	207

## Model Number/Catalog Number

MODEL NO.	CAT. NO.	STOCK	PAGE NO.	MODEL NO.	CAT. NO.	STOCK	PAGE NO.	MODEL NO.	CAT. NO.	STOCK	PAGE NO.	MODEL NO.	CAT. NO.	STOCK	PAGE NO.
KIT 320TDFS	A658	✓	207	KIT 444SB	444B2	✓	219	KIT 175984	A554	✓	208	KIT HS35A2048-FC	A740	✓	217
KIT 320U	32U28T	✓	219	KIT 444/5TCD-WD	A417	✓	205	KIT 175985	A581	✓	208	KIT HS35A2048-NV	A739	✓	217
KIT 324SB	324B2	✓	219	KIT 444/5TCD2-WD	A416	✓	205	KIT 175986	A555	✓	208	KIT HS35B1024-BC	A781	✓	217
KIT 326SB	326B2	✓	219	KIT 444/5TCF-WD	A427	✓	206	KIT 175987	A582	✓	208	KIT HS35B1024-FC	A783	✓	217
KIT 364-44SCB	A119	✓	214	KIT 444/5TCF2-WD	A426	✓	206	KIT 175988	A556	✓	208	KIT HS35B1024-NV	A779	✓	217
KIT 360BRFSR-314	A755	✓	216	KIT 445SB	445B2	✓	219	KIT 175989	A583	✓	208	KIT HS35B2048-BC	A782	✓	217
KIT 360 TERM BLK	A1002	✓	208	KIT 447/9TCD-WD	A419	✓	205	KIT 175990	A557	✓	208	KIT HS35B2048-FC	A784	✓	217
KIT 360TCD-WD	A169	✓	205	KIT 447/9 TERM BLK	A1004	✓	208	KIT 175991	A584	✓	208	KIT HS35B2048-NV	A780	✓	217
KIT 360TCD2-WD	A168	✓	205	KIT 447/9TCF-WD	A429	✓	206	KIT 175994	A559	✓	208	KIT HS35M1024	A742	✓	217
KIT 360TCD5	A196	✓	205	KIT 447/9TCF2-WD	A428	✓	206	KIT 175995	A580	✓	208	KIT HS35A/B1024-FC	A783A	✓	217
KIT 360TCF-WD	A179	✓	206	KIT 447SB	447B2	✓	219	KIT 631475	A561	✓	208	KIT HS35A/B2048-FC	A784A	✓	217
KIT 360TCF2-WD	A178	✓	206	KIT 449BBFS	A761	✓	216	KIT 635115	A569	✓	208	KIT HS35A/B1024-NV	A779A	✓	217
KIT 360TCFS	A197	✓	206	KIT 449BBFS-319	A788	✓	216	KIT 711485	A562	✓	208	KIT HS35A/B2048-NV	A780A	✓	217
KIT 360TCFSR	A395	✓	206	KIT 449BBFS-322	A787	✓	216	KIT 715130	A570	✓	208	KIT HSD351024-FC	A712	✓	217
KIT 360TCFSR-841	A188	✓	207	KIT 449BRFS	A758	✓	216	KIT 805165	A571	✓	208	KIT HSD351024-NV	A711	✓	217
KIT 360TDFC	A637	✓	207	KIT 449SB	449B2	✓	219	KIT 905165	A572	✓	208	KIT L449BBFS-322	A795	✓	216
KIT 360TSCDS	A199	✓	205	KIT 449TCFS	A623	✓	206	KIT 1005195	A573	✓	208	KIT L449TEBC	A796	✓	216
KIT 360TSCFSR	A396	✓	206	KIT 449TSCFS-1	A624	✓	206	KIT 1125195	A574	✓	208	KIT LDRDCR-M	A803	✓	214
KIT 360TSCFSR-841	A189	✓	207	KIT 449TSCFS-2	A625	✓	206	KIT 1325265	A575	✓	208	KIT LKSR02	A763	✓	217
KIT 360U	36U32T	✓	219	KIT 649R	A649	✓	207	KIT 1605300	A576	✓	208	KIT LKSR03	A764	✓	217
KIT 364SB	364B2	✓	219	KIT 650R	A650	✓	207	KIT 1805300	A577	✓	208	KIT LKSR512	A785	✓	217
KIT 365SB	365B2	✓	219	KIT 651R	A651	✓	207	KIT 2005350	A578	✓	208	KIT LKSR-CFACE	A786	✓	217
KIT 370-3	A371	✓	212	KIT 903	A903	✓	209	KIT 2255400	A579	✓	208	KIT M31024-FC	A754	✓	217
KIT 370-4	A372	✓	212	KIT 904	A904	✓	209	KIT 8014100	A563	✓	208	KIT M31024-NV	A753	✓	217
KIT 370-5	A373	✓	212	KIT 905	A905	✓	209	KIT 9014115	A564	✓	208	KIT M561024-BC	A794	✓	217
KIT 370-7.5	A375	✓	212	KIT 906	A906	✓	209	KIT 10014130	A565	✓	208	KIT M561024BRK-140	A748	✓	217
KIT 370-10	A376	✓	212	KIT 907	A907	✓	209	KIT 11194130	A566	✓	208	KIT M561024BRK-182	A749	✓	217
KIT 370-15	A378	✓	212	KIT 908	A908	✓	209	KIT 13194165	A567	✓	208	KIT M561024-NV	A793	✓	217
KIT 370-17.5	A379	✓	212	KIT 909	A909	✓	209	KIT 16014195	A568	✓	208	KIT M851024BRK-184	A750	✓	217
KIT 370-20	A380	✓	212	KIT 910	A910	✓	209	KIT A02H1024-BC LED	A668	✓	217	KIT M851024BRK-190	A751	✓	217
KIT 370-25	A381	✓	212	KIT 911	A911	✓	209	KIT A02H2048-BC LED	A669	✓	217	KIT M851024BRK-250	A752	✓	217
KIT 370-30	A382	✓	212	KIT 175058	A626	✓	205	KIT A688-10	A688-10	✓	217	KIT SGR-0.625-UK	A499-1	✓	218
KIT 400-445 TERM BLK	A1003	✓	208	KIT 175059	A627	✓	205	KIT A688-20	A688-20	✓	217	KIT SGR-0.875-UK	A499-2	✓	218
KIT 400BRFS-316	A756	✓	216	KIT 175060	A628	✓	205	KIT A688-25	A688-25	✓	217	KIT SGR-1.125-UK	A499-3	✓	218
KIT 400TCD-WD	A414	✓	205	KIT 175061	A654	✓	206	KIT A688-30	A688-30	✓	217	KIT SGR-1.375-UK	A499-4	✓	218
KIT 400TCD2-WD	A415	✓	205	KIT 175066	A602	✓	205	KIT A688-50	A688-50	✓	217	KIT SGR-1.625-UK	A499-5	✓	218
KIT 400TCD5	A202	✓	205	KIT 175067	A622	✓	205	KIT A688-60	A688-60	✓	217	KIT SGR-1.875-UK	A499-6	✓	218
KIT 400TCFS	A203	✓	206	KIT 175068	A652	✓	206	KIT A688-100	A688-100	✓	217	KIT SGR-2.125-UK	A499-7	✓	218
KIT 400TCFS-841	A190	✓	207	KIT 175077	A642	✓	206	KIT A690-15	A690-15	✓	217	KIT SGR-2.375-UK	A499-8	✓	218
KIT 400TCF-WD	A425	✓	206	KIT 175181	A600	✓	205	KIT BM6BRK	A312	✓	209	KIT SGR-2.875-UK	A499-9	✓	218
KIT 400TCF2-WD	A424	✓	206	KIT 175191	A653	✓	206	KIT BM6BRK115	A317	✓	209	KIT SGR-3.375-UK	A499-10	✓	218
KIT 400TDFS	A634	✓	207	KIT 175296	A643	✓	206	KIT BM6BRK575	A315	✓	209	KIT SGR-11.2	A500-5	✓	218
KIT 400TSCDS	A225	✓	205	KIT 175614	A662	✓	214	KIT BM10BRK	A313	✓	209	KIT SGR-14.4	A500-8	✓	218
KIT 400TSCFS	A226	✓	206	KIT 175601	A629	✓	205	KIT BM10BRK115	A318	✓	209	KIT SGR-20.7	A500-14	✓	218
KIT 400TSCFS-841	A191	✓	207	KIT 175691	A666	✓	206	KIT BM10BRK575	A316	✓	209	KIT SGR-27.1	A500-20	✓	218
KIT 400U	40U36T	✓	219	KIT 175810	A554A	✓	208	KIT BRK-3 115/230	A1306	✓	209	KIT SGR-33.4	A500-26	✓	218
KIT 404SB	404B2	✓	219	KIT 175811	A555A	✓	208	KIT BRK-3 208-230/460	A1301	✓	209	KIT SGR-39.8	A500-32	✓	218
KIT 405SB	405B2	✓	219	KIT 175812	A556A	✓	208	KIT BRK-3 575	A1297	✓	209	KIT SGR-46.1	A500-38	✓	218
KIT 440-7.5	A445	✓	212	KIT 175817	A581A	✓	208	KIT BRK-6 115/230	A1307	✓	209	KIT SGR-52.5	A500-44	✓	218
KIT 440-10	A446	✓	212	KIT 175818	A582A	✓	208	KIT BRK-6 208-230/460	A1302	✓	209	KIT SGR-58.8	A500-50	✓	218
KIT 440-12.5	A447	✓	212	KIT 175819	A583A	✓	208	KIT BRK-6 575	A1298	✓	209	KIT SGR-71.5	A500-62	✓	218
KIT 440-15	A448	✓	212	KIT 175827	A555B	✓	208	KIT BRK-10 208-230/460	A1303	✓	209	KIT SGR-84.2	A500-74	✓	218
KIT 440-17.5	A449	✓	212	KIT 175829	A551	✓	208	KIT BRK-10 575	A1299	✓	209	KIT SL561024-182NV	A789	✓	217
KIT 440BBFN	A760	✓	216	KIT 175828	A550	✓	208	KIT ENCBOX	A801	✓	217	KIT SL851024-184NV	A790	✓	217
KIT 440BRFN	A759	✓	216	KIT 175830	A552	✓	208	KIT EP2400	A496	✓	218	KIT SL851024-190NV	A791	✓	217
KIT 440BRFS-318	A757	✓	216	KIT 175831	A553	✓	208	KIT EPC260 2048	A686	✓	217	KIT SL851024-250NV	A792	✓	217
KIT 440TCD5	A228	✓	205	KIT 175832	A582B	✓	208	KIT HS201024-NV	A687	✓	217	KIT STUBSHAFT 1IN	A807	✓	217
KIT 440TCFN	A620	✓	206	KIT 175833	A589	✓	208	KIT HS25A1024-NV	A746	✓	217	KIT VRT87BRK	A157	✓	209
KIT 440TCFN-841	A194	✓	207	KIT 175834	A590	✓	208	KIT HS25A2048-NV	A747	✓	217				
KIT 440TCFS	A229	✓	206	KIT 175835	A594	✓	208	KIT HS351024-BC	A775	✓	217				
KIT 440TCFS-841	A192	✓	207	KIT 175836	A596	✓	208	KIT HS351024-FC	A774	✓	217				
KIT 440TSCDN	A293	✓	205	KIT 175837	A598	✓	208	KIT HS351024-NV	A772	✓	217				
KIT 440TSCDS	A231	✓	205	KIT 175844	A667	✓	206	KIT HS352048-BC	A778	✓	217				
KIT 440TSCFN	A621	✓	206	KIT 175890	A558	✓	208	KIT HS352048-FC	A777	✓	217				
KIT 440TSCFN-841	A195	✓	207	KIT 175900	A585	✓	208	KIT HS352048-NV	A776	✓	217				
KIT 440TSCFS	A232	✓	206	KIT 175901	A586	✓	208	KIT HS35A1024-BC	A738	✓	217				
KIT 440TSCFS-841	A193	✓	207	KIT 175902	A587	✓	208	KIT HS35A1024-FC	A737	✓	217				
KIT 440U	44U40T	✓	219	KIT 175903	A588	✓	208	KIT HS35A1024-NV	A736	✓	217				

# Regal Beloit America, Inc.

## MPN411 Terms and Conditions of Sale

REGAL BELOIT AMERICA, INC. TERMS AND CONDITIONS OF SALE ALL QUOTATIONS ARE MADE AND ALL ORDERS ARE ACCEPTED BY REGAL-BELOIT CORPORATION ELECTRICAL GROUP SUBJECT ONLY TO THESE TERMS AND CONDITIONS. THROUGHOUT THIS DOCUMENT, REGAL-BELOIT CORPORATION ELECTRICAL GROUP SHALL BE REFERRED TO AS SELLER.

### 1. MODIFICATIONS OF SALES TERMS:

Any Terms and Conditions contained in any purchase order or other form of communication from Seller's customers which are additional to or different from these Terms and Conditions shall be deemed rejected by Seller unless expressly accepted in writing by Seller. In general, no modification, amendment, waiver or other change of any of these Terms and Conditions and those contained on the reverse side hereof and/or in attachments hereto ("Terms and Conditions"), or of any of Seller's rights or remedies thereunder, shall be binding on Seller unless expressly accepted in writing by Seller's authorized officers. No course of dealing, usage of trade or course of performance shall be relevant to explain or supplement any of these Terms and Conditions. In case of conflict between the Terms and Conditions printed on this page and those contained on the face side or in attachments hereto, the latter shall control. If any document issued by any party hereto is sent by facsimile or another form of electronic document transmission, the parties hereto agree that (a) the copy of any such document printed on the facsimile machine or printer of the recipient thereof is a counterpart original copy thereof and is a "writing", (b) delivery of any such document to the recipient thereof by facsimile or such other form of electronic document transmission is authorized by the recipient thereof and is legally sufficient for all purposes as if delivered by United States mail, (c) the typewritten name of an authorized agent of the party sending such document on any such document is sufficient as a signature thereon on behalf of such party and the intent of such signature is to authenticate the writing, and (d) an electronically stored and reproduced copy of any such document shall be deemed to be legally sufficient evidence of the terms of such document for all purposes.

### 2. ACCEPTANCE OF ORDERS:

Acceptance by Seller of Buyer's purchase order(s) is expressly conditioned upon Buyer's assent to these Terms and Conditions. Buyer will be deemed to have assented to such Terms and Conditions unless Seller receives written notice of any objections within fifteen (15) days after Buyer's receipt of this form and in all events prior to any delivery or other performance by Seller of Buyer's order.

### 3. QUOTATIONS:

Quotations by Seller shall be deemed to be offers by Seller to sell the Goods described therein subject to these Terms and Conditions, and acceptance of such offers is expressly limited to acceptance by Buyer of all of these Terms and Conditions within thirty (30) days from the date of the quotation. Purchase orders submitted by Buyer for the Goods quoted by Seller shall be subject to and will be deemed to constitute acceptance of these Terms and Conditions. All purchase orders will be subject to approval by Seller.

### 4. PRICES; PRICE CHANGES:

All prices are net F.O.B. shipping point and are subject to change without notice. In the event of a change in Seller's prices, the price for Goods unshipped will be the price in effect on the date of shipment.

If Seller's quoted price was based upon delivery to and acceptance by Buyer of a specified quantity of Goods, such prices shall be subject to adjustment if Buyer does not accept the quantity at the times specified in Seller's quotation, and Buyer will be invoiced at Seller's standard price without quantity discounts, if any, for the quantity of Goods actually accepted by Buyer.

### 5. TAXES:

In addition to any prices, Buyer shall pay the amount of any present or future manufacturer's tax, retailer's occupation tax, use tax, sales tax, excise tax, duty, custom, inspection or testing fee, or any other tax, fee or charge of any nature whatsoever imposed by any governmental authority, on or measured by the transaction between Seller and Buyer. In the event Seller is required to pay any such tax, fee or charge, Buyer shall reimburse Seller therefor; or, in lieu of such payment, Buyer shall provide Seller at the time the order is submitted with an exemption certificate or other document acceptable to the authority imposing such tax, fee or charge.

### 6. TERMS OF PAYMENT:

All orders are subject to the approval of Seller. Terms of payment are cash in full no later than thirty (30) days from date of shipment, without discount. If, during the period of performance of an order, the financial condition of Buyer is determined by Seller not to justify the terms of payment specified, Seller may demand full or partial payment in advance before proceeding with the work, or satisfactory security or guarantees that invoices will be promptly paid when due, or, at its option without prejudice to other lawful remedies, may defer delivery or cancel this contract. If delivery is deferred, the Goods may be stored as provided in Section 9 hereof and Seller may submit a new estimate of cost for completion based on prevailing conditions. If Buyer defaults in any payment when due, or in the event any voluntary or involuntary bankruptcy or insolvency proceedings involving Buyer are initiated by or against Buyer, then the whole contract price shall immediately become due and payable upon demand, or Seller, at its option without prejudice to its other lawful remedies, may defer delivery or cancel this contract. Prorata payments shall become due as shipments are made. If shipments are delayed by the Buyer for any cause, payments shall become due from the date on which Seller is prepared to make shipment and storage shall be the Buyer's risk and expense as provided in Section 9 hereof. If manufacture is delayed by the Buyer for any cause, a partial payment based upon the proportion of the order completed shall become due from the date on which Seller is notified of the delay.

### 7. DELIVERY; RISK OF LOSS:

All sales are F.O.B. Seller's plant or other point of shipment designated by Seller. Shipping dates are estimates only which are not guaranteed and are based upon prompt receipt from Buyer of all necessary shipping and other information. Seller reserves the right to make delivery in installments, all installments to be separately invoiced and paid for by Buyer when due per invoice, without regard to subsequent deliveries. Delivery of Goods to a commercial carrier at Seller's plant

or other loading point shall constitute delivery to Buyer, and any risk of loss and further cost and responsibility thereafter for claims, delivery, loss or damage, including, if applicable, placement and storage, shall be borne by Buyer. When Goods are delivered by Seller's truck, unloading at Buyer's dock shall constitute delivery to Buyer. Claims for shortages or other errors in delivery must be made in writing to Seller within ten (10) days after receipt of shipment and failure to give such notice shall constitute unqualified acceptance and a waiver of all such claims by Buyer. Claims for loss or damage to Goods in transit by common carrier must be made to the carrier and not to Seller. Freight and handling charges by Seller may not reflect actual freight charges prepaid to the carrier by Seller due to incentive discounts earned by Seller based upon Seller's aggregate volume of freight tendered to a carrier or when a carrier must be used which charges a rate which is different than the rate upon which Seller's freight and handling charges were based. When shipments are delivered in Seller's private trucks Buyer will be charged an amount approximating the prevailing common carrier rate.

### 8. EXCUSABLE DELAYS; FORCE MAJEURE:

Seller shall not be liable for any ordinary, incidental, or consequential loss or damage as a result of Seller's delay in or failure of delivery or installation due to (i) any cause beyond Seller's reasonable control, (ii) an act of God, act of the Buyer, embargo or other government act, authority, regulation or request, fire, theft, accident, strike, slowdown or other labor disturbance, war, riot, delay in transportation, or (iii) inability to obtain necessary labor, materials, components, or facilities. Should any of the aforementioned events of force majeure occur, Seller, at its option, may cancel Buyer's order with respect to any undelivered Goods or extend the delivery date for a period equal to the time lost because of delay. Notice of such election shall be given promptly to Buyer. In the event Seller elects to so cancel the order, Seller shall be released of and from all liability for failure to deliver the Goods, including, but not limited to, any and all claims on behalf of Buyer for lost profits, or any other claim of any nature which Buyer might have.

If shipping or progress of the work is delayed or interrupted by Buyer, directly or indirectly, Buyer shall pay Seller for all additional charges resulting therefrom.

### 9. STORAGE:

If the Goods are not shipped within thirty (30) days after notification has been made to Buyer that it is ready for shipping, for any reason beyond Seller's control, including Buyer's failure to give shipping instructions, Seller may store the Goods at Buyer's risk and expense in a warehouse or on Seller's premises, and Buyer shall pay all handling, transportation and storage costs at the prevailing commercial rates promptly following Seller's submission of invoices for such costs.

### 10. WARRANTIES TO DISTRIBUTORS AND INDUSTRIAL OR COMMERCIAL CUSTOMERS:

This warranty is extended only to Seller's distributors and industrial or commercial customers and does not apply to consumer purchasers.

#### Warranty Period - Motors

The Seller warrants motors manufactured by or for it to be free from defects in materials and workmanship and to conform to its written specifications for a period of twelve (12) months from date of first use or eighteen (18) months from date of manufacture, whichever period shall expire first.

#### Warranty Period - Generators

(a) The Seller warrants standby generators manufactured by or for it to be free from defects in materials and workmanship and to conform to its written specifications for a period of twenty-four (24) months from date of startup, thirty (30) months from date of shipment, or one-thousand (1,000) hours in use, whichever period shall expire first; (b) Seller warrants continuous duty generators manufactured by or for it to be free from defects in materials and workmanship and to conform to its written specifications for a period of twelve (12) months from date of startup or eighteen (18) months from date of shipment, whichever period shall expire first.

Certain Regal Beloit America, Inc. Goods are warranted for different periods of time under specific conditions. Buyer must consult the current product catalog or internet site to confirm this warranty period.

Warranty Remedies - If, prior to expiration of the foregoing applicable warranty period, any of such Goods shall be proved to Seller's satisfaction to be defective or nonconforming, Seller will repair or replace such defective Goods or components thereof, F.O.B. Seller's plant or other destination designated by Seller, or will refund or provide Buyer with a credit in the amount of the purchase price paid therefor by Buyer, at Seller's sole option. Buyer's exclusive remedy and Seller's sole obligation under this warranty shall be limited to such repair or replacement, F.O.B. Seller's plant or other destination designated by Seller, or refund or credit by Seller, and shall be conditioned upon Seller's receiving written notice of any defect within a reasonable period of time (but in no event more than sixty (60) days) after it was discovered or by reasonable care should have been discovered. In no event shall Seller's liability for such defective or nonconforming Goods exceed the purchase price paid by Buyer therefor.

Exclusions - This warranty does not: (i) cover shipping expenses to and from Seller's factory or other destination designated by Seller for repair or replacement of defective Goods or any tax, duty, custom, inspection or testing fee, or any other charge of any nature related thereto, nor does it cover the costs of disassembling or removing defective Goods or reassembling, re-installing, or testing repaired or replaced Goods or finishing the reinstallation thereof; (ii) apply and shall be void with respect to Goods operated in excess of rated capacity or otherwise not in accordance with installation, maintenance, or operating instructions or requirements, to Goods repaired or altered by others than Seller or Seller's authorized service agencies, or to Goods which were subjected to abuse, negligence, misuse, misapplication, accident, damages by circumstances beyond Seller's control, to improper installation (if by others than Seller), operation, maintenance or storage, or to other than normal use or service; and (iii) apply to equipment or components not manufactured by or for Seller. With respect to Goods or components not manufactured by Seller, Seller's warranty obligations shall in all respects conform and be limited to the warranty actually extended to Seller by its suppliers, but in no event shall Seller's obligations be greater than those provided under Seller's warranty set forth in this Section 10.

**THE FOREGOING WARRANTIES ARE IN LIEU OF ALL OTHER EXPRESS AND IMPLIED WARRANTIES (EXCEPT TITLE), INCLUDING, WITHOUT LIMITATION, THE**

# Regal Beloit America, Inc.

## MPN411 Terms and Conditions of Sale

**IMPLIED WARRANTIES OF MERCHANTABILITY AND FITNESS FOR A PARTICULAR PURPOSE. NO EMPLOYEE, REPRESENTATIVE, OR AGENT OF SELLER OTHER THAN AN OFFICER OF SELLER IS AUTHORIZED TO ALTER OR MODIFY ANY PROVISION OF THIS SECTION 10 OR TO MAKE ANY GUARANTEE, WARRANTY, OR REPRESENTATION, EXPRESS OR IMPLIED, ORALLY OR IN WRITING, WHICH IS CONTRARY TO THE FOREGOING.** Any description of the Goods, whether in writing or made orally by Seller or Seller's agents, specifications, samples, models, bulletins, drawings, diagrams, engineering sheets or similar materials used in connection with Buyer's order are for the sole purpose of identifying the Goods and shall not be construed as an express warranty. Any suggestions by Seller or Seller's agents regarding use, application or suitability of the Goods shall not be construed as an express warranty unless confirmed to be such in writing by Seller's authorized officer.

### 11. LIMITATIONS OF LIABILITY; CONSEQUENTIAL DAMAGES:

**Nuclear Use Disclaimer** - Goods sold by Seller are not intended for use in connection with any nuclear facility or activity. If so used, Seller disclaims all liability for any nuclear damage, injury or contamination, and Buyer shall indemnify and hold Seller, its officers, agents, employees, successors, assigns and customers harmless from and against any and all losses, damages or expenses of whatever form or nature (including attorneys' fees and other costs of defending any action) which they or any of them may sustain or incur, whether as a result of breach of contract, warranty, tort (including negligence) or otherwise, by reason of such use.

**Consequential Damage Disclaimer** - Seller's liability with respect to Goods proved to its satisfaction to be defective within the warranty period shall be limited to repair, replacement or refund as provided in Section 10 hereof, and in no event shall Seller's liability exceed the purchase price of the Goods involved. Seller shall not be subject to any obligations or liabilities, whether arising out of breach of contract, warranty, tort (including negligence) or other theories of law, with respect to Goods sold or services rendered by Seller, or any undertakings, acts or omissions relating thereto. Without limiting the generality of the foregoing, Seller specifically disclaims any liability for property or personal injury damages, penalties, special or punitive damages, damages for lost profits or revenues, loss of use of Goods or any associated Goods, cost of capital, cost of substitute products, facilities or services, downtime, shutdown, or slowdown costs, or for any other types of economic loss, and for claims of Buyer's customers for any such damages.

**SELLER SHALL NOT BE LIABLE FOR AND DISCLAIMS ALL CONSEQUENTIAL, INCIDENTAL AND CONTINGENT DAMAGES WHATSOEVER. EVEN IF THE REPAIR OR REPLACEMENT REMEDY SHALL BE DEEMED TO HAVE FAILED OF ITS ESSENTIAL PURPOSE UNDER SECTION 2-719 OF THE UNIFORM COMMERCIAL CODE, SELLER SHALL HAVE NO LIABILITY TO BUYER FOR CONSEQUENTIAL DAMAGES, SUCH AS LOST PROFITS, LOST REVENUE, DAMAGE TO OTHER GOODS OR LIABILITY OR INJURY TO A THIRD PARTY.**

### 12. INDEMNIFICATION BY BUYER:

Buyer shall indemnify, hold harmless, and defend Seller and Seller's employees and agents from and against any and all damages, liability, claims, losses, and expenses (including reasonable attorneys' fees, court costs, and out-of-pocket expenses) arising out of or resulting in any way from claims by customers of Buyer or third parties against Seller alleging a breach of contract or warranty by Seller to the extent that such damages, liability, claims, losses, and expenses which may be payable by Seller to Buyer pursuant to and as limited by Seller's warranty and damage obligations as contained in Sections 10 and 11 hereof so as to effectively limit Seller's obligations to customers of Buyer or third parties to those set forth in Sections 10 and 11 hereof.

### 13. PATENT INDEMNIFICATION:

Seller will, at its own expense, defend or settle any suits that may be instituted against Buyer for alleged infringement by the Goods of any United States patent, provided that: (a) such alleged infringements consist of the use of the Goods for any of the purposes for which such Goods were sold; (b) Buyer shall have made all payments for such Goods then due hereunder; (c) Buyer shall give Seller immediate notice in writing of any such suit and transmit to Seller immediately upon receipt of all processes and papers served upon Buyer; and (d) Buyer shall permit Seller through its counsel, either in the name of Buyer or in the name of Seller, to defend such suit(s) and give all needed information, assistance and authority to enable Seller to do so. In case of a final award of damages in any such suit, Seller will pay such award but will not be responsible for any compromise or settlement made without its written consent. In case the Goods itself is in such suit held to infringe any valid patent issued in the United States and its use enjoined, or in the event of a settlement or compromise approved by Seller which shall preclude future use of the Goods sold to Buyer hereunder, Seller shall, at its own expense and at its sole option, either: (a) procure rights to continue using such Goods; (b) modify the Goods to render it noninfringing; (c) replace the Goods with non-infringing Goods; or (d) refund the purchase price paid by Buyer for the Goods after return of the Goods to Seller. Notwithstanding the foregoing, Seller shall not be held responsible for infringements of combination or process patents covering the use of Goods in combination with other Goods or materials not furnished by Seller.

The foregoing states the entire liability of Seller for patent infringement, and **IN NO EVENT SHALL SELLER BE LIABLE FOR CONSEQUENTIAL OR INCIDENTAL DAMAGES ATTRIBUTABLE TO AN INFRINGEMENT** nor for infringement based on the use of the Goods for a purpose other than that for which sold by Seller. As to any Goods furnished by Seller to Buyer manufactured in accordance with designs proposed or furnished by Buyer or any claim of contributory infringement resulting from the use or resale by Buyer of Goods sold hereunder, Buyer shall indemnify Seller for any award made against Seller or settlement by Seller for any patent, trademark or copyright infringements including attorneys' fees and defense costs.

### 14. SECURITY AGREEMENT AND FINANCING STATEMENTS:

To secure payment of the purchase price and of all monies which may be due hereunder, and performance of all of Buyer's obligations hereunder, Buyer hereby grants to Seller a security interest in all Goods sold by Seller, and agrees to execute such other Security Agreements and Financing Statements as Seller may reasonably request.

### 15. INSURANCE:

Until payment in full of the purchase price, Buyer shall maintain insurance covering all Goods sold by Seller to Buyer in such amounts and against such risks as is customary by companies engaged in the same or similar business and similarly located, and shall, upon Seller's request, furnish evidence of such insurance satisfactory to Seller.

### 16. DRAWINGS; OTHER DESIGN DATA:

All specifications, drawings, designs, data, information, ideas, methods, tools, gages, dies, fixtures, patterns and/or inventions made, conceived, developed or acquired by Seller in connection with procuring and/or executing Buyer's order will vest in and inure to Seller's sole benefit notwithstanding any changes thereto which may have been or may be imposed by Seller.

Buyer shall not give, loan, exhibit, sell or transfer to any person not then employed by Buyer and authorized to receive such information, or to any organization or entity, any drawing, photograph or specification furnished by Seller or reproduction thereof which may enable such person, organization or entity to furnish similar Goods or parts thereof.

### 17. RETURN OF GOODS:

No Goods or part shall be returned to Seller without written authorization and shipping instructions first having been obtained from Seller.

### 18. ASSIGNMENT AND SUBCONTRACTING:

None of the Buyer's rights under any order shall be assigned by the Buyer to any other person, whether by operation of law or otherwise, without Seller's prior written approval. Seller may, without the necessity of obtaining Buyer's prior written consent, subcontract the production of all or any portion of the Goods.

### 19. CANCELLATION:

No order submitted to Seller may be cancelled by Buyer without the prior written consent of Seller, which consent will at all times be conditioned on Buyer's agreement to pay Seller's cancellation charge. For finished Goods which in Seller's judgement is readily resalable to others, the cancellation charge shall be 15% of the invoice price of the Goods. For all other cancellations, the cancellation charge shall amount to all cost and expenses incurred by Seller and arising out of or in connection with Buyer's order, net of recoverability, but in no event less than 10% of the invoice price of the Goods or more than the invoice price.

### 20. GENERAL:

**Governing law** - These Terms and Conditions, and the contract of sale between Seller and Buyer, shall be governed by and construed in accordance with the laws of the State of Wisconsin. Seller and Buyer hereby agree that any legal action deemed necessary by either party hereto shall be brought in the Circuit Court in and for Seller County, Wisconsin and hereby consent to the personal jurisdiction of such court in any such action over the parties hereto. The rights and obligations of Seller and Buyer shall not be governed by the provisions of the United Nations Convention on Contracts for the Internal Sale of Goods.

**Attorneys' Fees** - Buyer agrees to pay all of Seller's costs and expenses of collection and related litigation, including but not limited to attorneys' fees and costs.

**Severability** - The invalidity, in whole or in part, of any of the provisions of these Terms and Conditions, shall not affect the enforceability of any of the other provisions thereof.

**Applicability** - The Terms and Conditions as stated herein are applicable as of the date of this printing and until such time as changed by Seller.



# IMPORTANT INFORMATION

## Please Read Carefully



This catalog is not intended to provide operational instructions. Appropriate Marathon Motors instructions provided with the motor and precautions attached to the motor should be read carefully prior to installation, operation and/or maintenance of the equipment. Injury to personnel or motor failure may be caused by improper installation, maintenance or operation.

The following **WARNING** and **CAUTION** information is supplied to you for your protection and to provide you with many years of trouble free and safe operation of your Marathon Motors product:



- Disconnect power and lock out driven equipment before working on a motor.
- Always keep hands and clothing away from moving parts.
- The lifting support on the motor is not to be used to lift the entire machine. Only the motor attached directly to the support may be safely lifted by the support.
- Install and ground per local and national codes.
- Discharge all capacitors before servicing a single phase motor.
- Misapplication of a motor in a hazardous environment can cause fire or an explosion and result in serious injury. Only the end user, local authority having jurisdiction, and/or insurance underwriter are qualified to identify the appropriate class(es), group(s), division and temperature code. Marathon Motors personnel can not evaluate or recommend what motors may be suitable for use in hazardous environments. If a motor is nameplated for hazardous locations, do not operate the motor without all of the grease and drain plugs installed.
- Never attempt to measure the temperature rise of a motor by touch. Temperature rise must be measured by thermometer, resistance, imbedded detector or thermocouple.
- Motors with automatic reset thermal protectors will automatically restart when the protector temperature drops sufficiently. Do not use motors with automatic reset thermal protectors in applications where automatic restart will be hazardous to personnel or equipment.
- Motors with manual reset thermal protectors may start unexpectedly after the protector trips when the surrounding air is at +20°Fahrenheit or lower. If the manual reset protector trips, disconnect motor from its power supply. After the protector cools (five minutes or more), it can be reset and power may be applied to the motor.
- Connect all protective device leads, marked P1, P2, etc., per instructions supplied with the motor.
- Operation of a motor at other than its nameplate rating may result in fire, damage to equipment or serious injury to personnel.
- For safety, Buyer or User should provide protective guards over all shaft extensions and any moving apparatus mounted thereon. The User is responsible for checking all applicable safety codes in his area and providing suitable guards. Failure to do so may result in bodily injury and/or damage to equipment.



- Consult qualified personnel with questions and all electrical repairs must be performed by trained and qualified personnel only.
- For motors nameplated as "belted duty only", do not operate the motor without belts properly installed.
- Motors and/or driven equipment should not be operated faster than their rated speed.
- For inverter applications, follow the inverter manufacturer's installation guidelines.
- Make sure the motor is properly secured and aligned before operation.

### Resale of Goods

In the event of the resale of any of the goods, in whatever form, Resellers/Buyers will include the following language in a conspicuous place and in a conspicuous manner in a written agreement covering such sale:

The manufacturer makes no warranty or representations, express or implied, by operation of law or otherwise, as to the merchantability or fitness for a particular purpose of the goods sold hereunder. Buyer acknowledges that it alone has determined that the goods purchased hereunder will suitably meet the requirements of their intended use. In no event will the manufacturer be liable for consequential, incidental or other damages. Even if the repair or replacement remedy shall be deemed to have failed of its essential purpose under Section 2-719 of the Uniform Commercial Code, the manufacturer shall have no liability to Buyer for consequential damages.

Resellers/Buyers agree to also include this entire document including the warnings and cautions above in a conspicuous place and in a conspicuous manner in writing to instruct users on the safe usage of the product.

This information should be read together with all other printed information supplied by Marathon Motors.

For more information contact: **Regal Beloit America, Inc.**, 100 E. Randolph St., Wausau, WI 54401 Phone: 715-675-3311 or Fax: 715-675-8030.

# FREQUENTLY ASKED QUESTIONS

## ENERGY INDEPENDENCE AND SECURITY ACT OF 2007 (“EISA”)

These materials are intended to provide general information (not legal or other advice) about important new legislation or developments. These materials are not intended to substitute for a thorough analysis of the subject covered or any subsequent developments relating to that subject.

**Q. Are medium voltage motors covered by EISA?**

A. No. EISA only covers motors that are operational at 60 Hz with voltages through 600 V.

**Q. Must 60/50 Hz rated motors meet EISA efficiencies?**

A. Yes, 60/50 Hz motors must comply with the applicable efficiency requirement at the 60 Hz rating. 50 Hz only motors are exempt.

**Q. What efficiencies are documented in NEMA tables 12-11, 12-12, 12-13 and 12-14?**

A. NEMA table 12-11 defines efficiencies associated with EPart. 12-12 contains efficiencies associated with NEMA Premium (former CEE efficiencies). 12-13 defines medium voltage (>600V). 12-14 defines NEMA Premium levels @ 50 Hz.

**Q. Must spread voltage (eg. 200-230/460V) or tri-voltage (eg. 230/460/796) rated motors meet EISA efficiencies at all rated voltages?**

A. Yes. The motor must meet the required efficiency at each rated voltage on the nameplate. Note that since the efficiency requirements of the stated voltages may vary (200V must meet “EPart”/Table 12-11, whereas 230 & 460 must meet “NEMA Premium”/Table 12-12), varying efficiency claims must be made on the same nameplate.

**Q. What about 208 volt?**

A. Our view on 208 volt, is that it must meet EPart efficiencies.

**Q. Are single phase motors covered by EISA?**

A. No, regardless of motor frame size or HP rating.

**Q. Are 48 and 56 frame motors covered by EISA?**

A. No. However there are discussions about the possible establishment of efficiency standards for fractional HP motors.

**Q. Are “inverter duty” motors covered by EISA?**

A. Yes, if the motor is operational at 60 Hz. If the motor can be used as a “general purpose” motor, it must meet EISA-mandated efficiency. Special V/Hz motors (eg. 45Hz/230V) are not covered, nor are special ventilation schemes such as blower cooled or TENV.

**Q. Are motors that are intermittent duty or 60 minute duty covered?**

A. Motors that are truly intermittent duty or time limited and will fail if operated continuously are not covered. Motors that are labeled for less than continuous duty but are capable of operating continuously are covered.

**Q. Are motors with brakes covered? What about gearmotors?**

A. Motors that have brakes installed on the motor are not covered. Motors that are purchased with a shaft extension or “brake provisions” are covered. Motors that are part of the gear assembly and share bearings or other components such that they cannot operate without the gear assembly are not covered. Motors that can be operated separately but are used with a gearbox are covered.

**Q. Are motors with encoders or encoder provisions covered?**

A. Yes, both motor with encoders and motors with encoder provisions are covered based upon their other features such as enclosure, voltage and frequency. The inclusion of an encoder or other accessories is not required for the motor to operate so they are not considered reasons for exemption.

**Q. Are multi-speed motors covered?**

A. No, multi-speed motors (ex: 25/12.5hp 1800/900rpm) are not covered. There are no efficiency levels established for multi-speed motors so they cannot be labeled as EPart or NEMA Premium regardless of the efficiency value.

**Q. Are eight (8) pole motors covered?**

A. Yes, eight-pole motors operating on 60Hz power supplies are covered. There are no NEMA Premium efficiency levels defined for eight-pole motors so they cannot be labeled as NEMA Premium even if the efficiency exceeds EPart (Table 12-11) levels.

# NEMA MG-1 Table 12-11 Full Load Efficiencies of EPart Efficient Electric Motors

HP	NOMINAL FULL LOAD EFFICIENCY							
	OPEN FRAME				ENCLOSED FRAME			
	2 POLE	4 POLE	6 POLE	8 POLE	2 POLE	4 POLE	6 POLE	8 POLE
1	N/A	82.5	80.0	74.0	75.5	82.5	80.0	74.0
1 1/2	82.5	84.0	84.0	75.5	82.5	84.0	85.5	77.0
2	84.0	84.0	85.5	85.5	84.0	84.0	86.5	82.5
3	84.0	86.5	86.5	86.5	85.5	87.5	87.5	84.0
5	85.5	87.5	87.5	87.5	87.5	87.5	87.5	85.5
7 1/2	87.5	88.5	88.5	88.5	88.5	89.5	89.5	85.5
10	88.5	89.5	90.2	89.5	89.5	89.5	89.5	88.5
15	89.5	91.0	90.2	89.5	90.2	91.0	90.2	88.5
20	90.2	91.0	91.0	90.2	90.2	91.0	90.2	89.5
25	91.0	91.7	91.7	90.2	91.0	92.4	91.7	89.5
30	91.0	92.4	92.4	91.0	91.0	92.4	91.7	91.0
40	91.7	93.0	93.0	91.0	91.7	93.0	93.0	91.0
50	92.4	93.0	93.0	91.7	92.4	93.0	93.0	91.7
60	93.0	93.6	93.6	92.4	93.0	93.6	93.6	91.7
75	93.0	94.1	93.6	93.6	93.0	94.1	93.6	93.0
100	93.0	94.1	94.1	93.6	93.6	94.5	94.1	93.0
125	93.6	94.5	94.1	93.6	94.5	94.5	94.1	93.6
150	93.6	95.0	94.5	93.6	94.5	95.0	95.0	93.6
200	94.5	95.0	94.5	93.6	95.0	95.0	95.0	94.1
250	94.5	95.4	95.4	94.5	95.4	95.0	95.0	94.5
300	95.0	95.4	95.4	N/A	95.4	95.4	95.0	N/A
350	95.0	95.4	95.4	N/A	95.4	95.4	95.0	N/A
400	95.4	95.4	N/A	N/A	95.4	95.4	N/A	N/A
450	95.8	95.8	N/A	N/A	95.4	95.4	N/A	N/A
500	95.8	95.8	N/A	N/A	95.4	95.8	N/A	N/A

NEMA TABLE 12-12



# NEMA MG-1 Table 12-12 Full Load Efficiencies for 60 Hz NEMA Premium® (CEE) Efficient Electric Motors Rated 600 Volts or less (Random Wound)

HP	NOMINAL FULL LOAD EFFICIENCY							
	OPEN FRAME				ENCLOSED FRAME			
	2 POLE	4 POLE	6 POLE	8 POLE	2 POLE	4 POLE	6 POLE	8 POLE
1	77.0	85.5	82.5	N/A	77.0	85.5	82.5	N/A
1 1/2	84.0	86.5	86.5	N/A	84.0	86.5	87.5	N/A
2	85.5	86.5	87.5	N/A	85.5	86.5	88.5	N/A
3	85.5	89.5	88.5	N/A	86.5	89.5	89.5	N/A
5	86.5	89.5	89.5	N/A	88.5	89.5	89.5	N/A
7 1/2	88.5	91.0	90.2	N/A	89.5	91.7	91.0	N/A
10	89.5	91.7	91.7	N/A	90.2	91.7	91.0	N/A
15	90.2	93.0	91.7	N/A	91.0	92.4	91.7	N/A
20	91.0	93.0	92.4	N/A	91.0	93.0	91.7	N/A
25	91.7	93.6	93.0	N/A	91.7	93.6	93.0	N/A
30	91.7	94.1	93.6	N/A	91.7	93.6	93.0	N/A
40	92.4	94.1	94.1	N/A	92.4	94.1	94.1	N/A
50	93.0	94.5	94.1	N/A	93.0	94.5	94.1	N/A
60	93.6	95.0	94.5	N/A	93.6	95.0	94.5	N/A
75	93.6	95.0	94.5	N/A	93.6	95.4	94.5	N/A
100	93.6	95.4	95.0	N/A	94.1	95.4	95.0	N/A
125	94.1	95.4	95.0	N/A	95.0	95.4	95.0	N/A
150	94.1	95.8	95.4	N/A	95.0	95.8	95.8	N/A
200	95.0	95.8	95.4	N/A	95.4	96.2	95.8	N/A
250	95.0	95.8	95.4	N/A	95.8	96.2	95.8	N/A
300	95.4	95.8	95.4	N/A	95.8	96.2	95.8	N/A
350	95.4	95.8	95.4	N/A	95.8	96.2	95.8	N/A
400	95.8	95.8	95.8	N/A	95.8	96.2	95.8	N/A
450	95.8	96.2	96.2	N/A	95.8	96.2	95.8	N/A
500	95.8	96.2	96.2	N/A	95.8	96.2	95.8	N/A

NEMA TABLE 12-12

# *Our New Corporate Identity is Simply "Regal"*



## ***SIMPLE.***

Regal-Beloit Corporation, the parent of Marathon Motors, is in the midst of simplification. We are streamlining our business processes, standardizing our computer systems, and improving our communications – all with the idea of making it easier for customers to do business with us.

## ***DYNAMIC.***

As a corporation, we are becoming a more dynamic enterprise—continuously innovating and growing to reach more customers in more markets. And we are doing so with the confidence that comes with our years of industry experience.



## ***BOLD.***

As we bring life to the new Regal identity, our brand boldly reflects our corporate objective to become a more focused, integrated and customer centric company.

As a premier Regal brand, Marathon Motors will continue as a dynamic and customer focused brand serving partners around the world. The Marathon Motors brand promise remains providing customers with a vast array of efficient solutions for commercial and industrial applications performing every day for the long run.



# Solutions for the Long Run

Specifications	Features	GLOBE-TROTTER®	BLUE CHIP® XRI®	BLUE CHIP® XRI®-SD	BLUE CHIP® XRI®-841	BLUE CHIP® XRI®-XP
Enclosures	Totally Enclosed Fan Cooled	•	•		•	•
	Open Dripproof	•	•			
Voltage	208-230/460 volt through 100 HP; 460 volt 125 HP and larger	•				
	230/460 volt through 100 HP, 460 volt 125 HP and larger		•	•		•
	460 volt (three lead)			•	•	•
	575 volt (three lead)	•		•	•	•
Service Factor (sine wave)	1.15	•	•	•	•	•
	1.25 through 40 HP (see SB300 catalog for restrictions)		•	•	•	•
Inverter Duty	10:1 variable torque	•	•	•	•	•
	Up to 10:1 constant torque	•	•	•	•	•
	Up to 20:1 constant torque		•	•	•	
	Provisions to add hollow shaft encoder (TEFC only)			•	•	
Insulation System	Non-hygroscopic Class F system 143T-445T, Class H 447/9T	•	•			
	MAX GUARD®			•	•	•
Balance	Special balance average 0.08 in/sec.			•	•	•
Bearings & Lubrication	Shielded ball bearings, C-3 fit with premium Mobil Polyrex EM grease (-30°C to +150°C)	•	•	•	•	•
	Open bearings, 364T Frame and larger	•				
	Zerk fittings (Globetrotter 324T and larger)	•		•	•	•
	Extended grease tubes for regreasing without disassembly			•	•	
Bearing Caps	Cast iron, 182T and larger					•
	Cast iron, 254T and larger	•			•	
	Cast iron, 444T and larger		•			
Construction	Rolled Steel	•	•	•		
	Cast Iron	•	•	•	•	•
Conduit Box	Steel 56-326T, Cast iron (364T and larger, non threaded)		•			
	Steel 143T-215T, Cast iron 254T and larger, non threaded	•				
	Cast iron, oversized, fully gasketed				•	•
Leads	Lead lugs 364T and larger		•	•	•	•
	Permanently marked leads with lead separator				•	•
Fan Guard (TEFC)	Polypropylene (143T-213T), Steel (254T and larger)	•				
	Polypropylene (182T-326T)		•			
	Cast iron (including XRI 364T and larger)		•	•	•	•
Fan (External)	Non-sparking polypropylene (TEFC)	•	•	•	•	•
Drains	Corrosion resistant brass drain and breather			•	•	•
	Drilled and tapped hole		•			
	Drain hole 143T-326T, drilled and tapped hole 364T and larger	•				
Epoxy Finish	Internal and external corrosion resistant epoxy			•	•	•
Hardware	Corrosion resistant zinc dichromate plated hex head hardware		•	•	•	•
	Lifting provisions, 182T and larger	•	•	•	•	•
Ground	Ground lug provision in conduit box	•	•	•	•	•
	External grounding provision					•
Nameplate	Stainless steel - includes NEMA nominal efficiency and power factor	•	•	•	•	•
	AFBMA bearing identification plate			•	•	•
Seals	Inpro/Seal VBX Bearing Isolators on drive end of TENV and both ends of TEFC				•	
Slinger	Molded neoprene slinger on shaft end	•	•	•	•	•
Marine Duty	Meets IEEE45 and USCG			•	•	•
	Meets API RP14F for offshore platforms				•	
Division 1 Hazardous Duty	CSA Certification, UL Listed, Class I & II Groups C,D,F,G, Temperature Code T3B					•
Division 2 Hazardous Duty	CSA Certification nameplate, Class 1 Groups A, B, C, D, Temperature Code T2B			•	•	
Motor Testing	Actual short commercial test data supplied for catalog numbers that do not end with "A"		•			
	Actual short commercial test data plus max. vibration test supplied with each motor			•		•
	Actual short commercial test data plus 2 additional vibration tests supplied with each motor					•
Agency Listings	UL Recognized	•	•	•	•	•
	CSA Certified	•	•	•	•	•
	CE Mark	•	•	•	•	•
Warranty	36 mo. from date of first use, 42 mo. from date of manufacture	•	•	•		•
	60 mo. from date of first use, 66 mo. from date of manufacture				•	
	Optional extended warranty			•	•	



**Globetrotter®**  
TEFC & ODP



**Blue Chip® XRI®**  
TENV & TEFC



**Blue Chip® XRI® - Severe Duty**  
TENV & TEFC



**Blue Chip® XRI® - 841**  
I IEEE 841



**Blue Chip® XRI® - Hazardous Duty**  
Division 1, Class I & II  
Groups C, D, F & G



# Footnotes

1	Capacitor Start/Capacitor Run design for reduced amperage	77	Frame size is drilled with three sets of footholes, 5010, 5011, and 5012 as standard. Foothole drilling for 5009 available upon request, as a build-up
2	Capacitor Start Induction Run design	78	Frame size is drilled with two sets of footholes, 5012 and 5013 standard
3	Split Phase design	79	Ball brgs on both ends suitable for direct connection. For belted applications, refer to Customer Service
4	Sleeve bearing	80	Rolled steel fan guard on 143T-145T
5	56H, 143T, and 145T Combination Base with 12 mounting holes	81	24" long #18 SO 2-conductor cord out shell at 11 o'clock position
6	Bolt-on removable base for footless mounting option	82	Welded Rigid Base
7	Shaft extension 1-1/2" long by 1/2" diameter	83	Shaft extension 1-7/8" long by 5/8" diameter with 6-3/8" mounting flange
8	Shaft extension 1-7/8" long by 1/2" diameter	84	NEMA 145T C-Face mounting with removable 182T rigid base
9	Shaft extension 2-1/4" long by 1/2" diameter	85	Not tach adaptable
10	Shaft extension 2-1/4" long by 5/8" diameter	86	2:1 constant torque speed range; RTM for greater torque capability
11	Shaft extension 2-1/4" long by 7/8" diameter	87	10:1 Constant Torque available as build-up, RTM for price and availability
12	With rigid base	88	182T base and shaft height, 145TC mounting face and shaft dimensions
13	F1 Mounting only, cannot reassemble to F2	89	Threaded NPT opening in conduit box
14	Will accept C-Face kit, see Accessory Section	90	Not UL Recognized
15	Fixed CW Rotation, viewing opposite shaft (or lead end) of motor	91	Suitable for use on VFD at 208 volt
16	Fixed CCW Rotation, viewing opposite shaft (or lead end) of motor	92	7/8" Thru-bolts, shaft end
17	1.0 Service Factor	93	Permanent split capacitor-switchless
18	1.15 Service Factor	94	1/2" Thru-bolts, shaft end
19	1.25 Service Factor	95	Will not accept drip cover kit
20	1.35 Service Factor	96	3 lead reversible design works with single pole, double throw reversing switch
21	Double shaft extension 1-1/2" long by 1/2" diameter with flat each end	97	Addition of D-Flange kit will result in non-NEMA "BA" dimension (1/2" longer than NEMA) and non-NEMA shaft extension (1/2" shorter than NEMA).
22	Double shaft extension 1-7/8" long by 5/8" diameter each end	98	Not UL Listed for Fire Pump applications
23	Shaft extension 3/8" diameter	99	Suitable for 2:1 CT operation
24	Motor will NOT accept a Brake kit	100	6" shaft extension with 2 flats 90° apart
25	Motor will NOT accept C-Face Kits	110	1.20 Service Factor
26	5/8" shaft adapter included	111	1.30 Service Factor
27	Drip Cover included	112	1.40 Service Factor
28	Steel Endshields	113	1.50 Service Factor
29	Weep holes with removable plugs on end brackets. Remove bottom plug after installation	114	1.60 Service Factor
30	Resilient ring mount, base not included	115	1.75 Service Factor
31	5/8" Thru-bolts, shaft end	116	1-3/4" thru-bolt extension on shaft-end
32	3/4" Thru bolts, shaft end	2:1	Suitable for 2:1 CT operation; consult "R164 Rework" table for fan change pricing to upgrade to 10:1 CT
33	Shaft extension 6" long by 5/8" diameter with full flat and key 90° apart	A	NEMA Design A
34	1" Thru-bolts, shaft end	B	NEMA Design B
35	1-1/8" Thru-bolts, shaft end	C	NEMA Design C
36	1-1/4" Thru-bolts, shaft end	D	Will become build-up item when current stock is gone
37	1-1/2" Thru-bolts, shaft end	E	Design incorporates electronic switch
38	2" Thru-bolts, shaft end	F	Class F Insulation
39	No Thru-bolts, shaft end	H	Class H Insulation
40	Space heaters and 100 ohm platinum stator RTDs included	I	Reduced HP @ 120 HZ
41	1/2" Thru-bolts, opposite shaft end	N	Totally Enclosed, Non-Ventilated
42	3/4" Thru-bolts, opposite shaft end	P	BCP (Bearing Current Protection)
43	2-1/2" Resilient Rings included	Q	Quick Connect" terminal board
44	1" Thru-bolts, opposite shaft end	S	Steel Frame Construction
45	60° C ambient	V	Suitable for 10:1 CT 60 minute duty, otherwise 2:1 CT
46	65° C ambient	X	XRI, Ultra High Efficiency Design
47	Connected for CCW rotation (U.S. standard) facing opposite shaft end. Reversible by reconnection of leads	Z	56HZ with 7/8" shaft dia., 3-1/2" shaft height, and slotted 56 frame base
48	Connected for CW rotation (Canadian standard) facing opposite shaft end. Reversible by reconnection of leads	AH	Conforms to GM 7EH and satisfies Ford EM-1 and GM 7EQ
49	Shaft extension 1-13/16" long by 1/2" diameter with 6-3/8" mounting flange	AL	Aluminum Frame Construction
50	Designed for 50 Hz operation	AQ	Conforms to GM 7EQ and satisfies Daimler Chrysler NPEM-100, and Ford EM-1
51	Does not include resilient rings, see Accessory Section	BI	Class B Insulation
52	1/2" x 1-7/8" Shaft with 1-5/8" Flat	BP	Separate power supply required for blower motor
53	1/2" Shaft with 5/8" adapter and Key	CD	Suitable for Group C
54	30 minute duty cycle, not rated for continuous duty	CF	Consult Factory for Accessory Kit and/or Modification Selection
55	Shaft extension 3-13/16" long by 5/8" diameter with 3.5" keyway	CT	Suitable for 20:1 CT on Vector Drive, continuous duty or 2000:1 Energy Saver Design
56	1-5/8" Thru-bolts, shaft end	FN	Drive has cooling fan
57	Open construction	NE	Exempt from NEMA Premium efficiency requirement
58	Capacitor supplied with motor	NP	Does not meet NEMA PremiumR efficiency
59	TEAO construction	NS	Single Shielded Ball Bearings
60	Foot locating Set Screws on frame, 90 apart	PW	Part Winding Start Capability
61	10" Leads	RB	Roller Bearing on shaft end for belted load only
62	43" Leads	SH	Space heaters
63	1-1/2" Thru-bolts, opposite shaft end	SL	Sound level exceeds standard
65	Mounting accessories and resilient ring for pulley end are not included. Use accessory kit 161L131AB1 for resilient ring mounting	TS	Normally Closed Thermostats installed
67	Capacitor not included, see Accessory Section	VB	Vibration not met
68	Rated 60/50 hertz, 190/380 or 380 volt at next lower horsepower	VC	Voltage Change Device feature for quick voltage changes
69	50° C Ambient	YD	12 Leads for WYE-DELTA, Part Winding on low voltage, or across-the-line starting
70	Not Nameplated 50 hz		
71	Includes length adapter bracket		
72	Usable on 200 Volts at 1.0 service factor		
73	No hubs		
74	Split phase/capacitor run electrical design		
75	Addition of C-Face Kits may result in non-NEMA "BA", dimension. For the resulting "BA" dimension consult chart found in modification section		
76	Addition of C-Face Kits in non-NEMA "AH" dimension. "AH" is 2.12, Rework "AH" is 2.38		

# IEC Quick Reference Dimensional Chart

## B3 Foot-Mounted (Ridge Base)

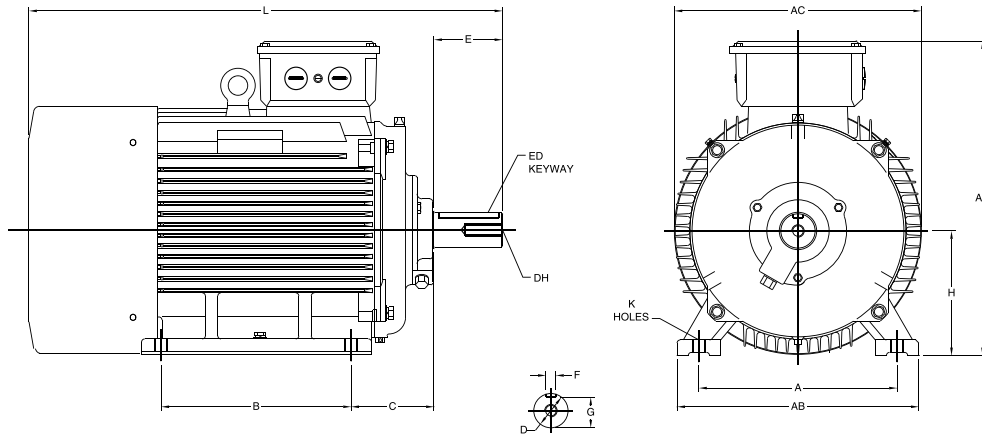

## IEC Frame Dimensions (Millimeters)

FRAME	MOUNTING						SHAFT						GENERAL			B5 (FF) FLANGE					B14 (FT) FACE						
	A	B	C	H	AB	K	D	E	F	G	ED	DH	AC	AD	HD	M	N	P	S	T	LA	M	N	P	S	T	LA
63	100	80	40	63	119	7	11	23	4	8.5	10	M4 x 10	126	-	169	115	95	140	10	3.0	7	75	60	90	M5	2.5	7
71	112	90	45	71	131	7	14	30	5	11.0	20	M5 x 12.5	140	-	186	130	110	160	10	3.5	7	85	70	105	M6	2.5	9
80	125	100	50	80	157	10	19	40	6	15.5	25	M6 x 16	158	132	212	165	130	200	12	3.5	12	100	80	120	M6	3.0	9
90S	140	100	56	90	174	10	24	50	8	20.0	32	M8 x 19	178	140	230	165	130	200	12	3.5	12	115	95	140	M8	3.0	9
90L	140	125	56	90	174	10	24	50	8	20.0	32	M8 x 19	178	140	230	165	130	200	12	3.5	12	115	95	140	M8	3.0	9
100L	160	140	63	100	205	12	28	60	8	24.0	40	M10 x 22	215	178	278	215	180	250	15	4.0	11	130	110	160	M8	3.5	14
112M	190	140	70	112	245	12	28	60	8	24.0	40	M10 x 22	220	190	302	215	180	250	15	4.0	12	130	110	160	M8	3.5	11
132S	216	140	89	132	280	12	38	80	10	33.0	56	M12 x 28	275	210	342	265	230	300	15	4.0	12	165	130	200	M10	3.5	14
132M	216	178	89	132	280	12	38	80	10	33.0	56	M12 x 28	275	210	342	265	230	300	15	4.0	12	165	130	200	M10	3.5	14
160M	254	210	108	160	325	15	42	110	12	37.0	80	M16 x 36	325	254	414	300	250	350	19	5.0	13	215	180	250	M12	4.0	13
160L	254	254	108	160	325	15	42	110	12	37.0	80	M16 x 36	325	254	414	300	250	350	19	5.0	13	215	180	250	M12	4.0	13
180M	279	241	121	180	335	15	48	110	14	42.5	80	M16 x 36	360	310	490	300	250	350	19	5.0	15	<b>NOT DEFINED BY IEC 72</b>					
180L	279	279	121	180	335	15	48	110	14	42.5	80	M16 x 36	360	310	490	300	250	350	19	5.0	15						
200L	318	305	133	200	395	19	55	110	16	49.0	100	M20 x 42	400	340	540	350	300	400	19	5.0	19.5						
225S	356	286	149	225	435	19	55*/ 60	110*/ 140	16*/ 18	49*/ 53	100*/ 125	M20 x 42	445	414	639	400	350	450	19	5.0	21.0						
225M	356	311	149	225	435	19	55*/ 60	110*/ 140	16*/ 18	49*/ 53	100*/ 125	M20 x 42	445	414	639	400	350	450	19	5.0	21.0						
250M	406	349	168	250	490	24	60*/ 65	140	18	53*/ 58	125	M20 x 42	500	440	690	400	350	450	19	5.0	21.0						

\*2 Pole Dimensions

1mm = .03937", 1" = 25.4mm

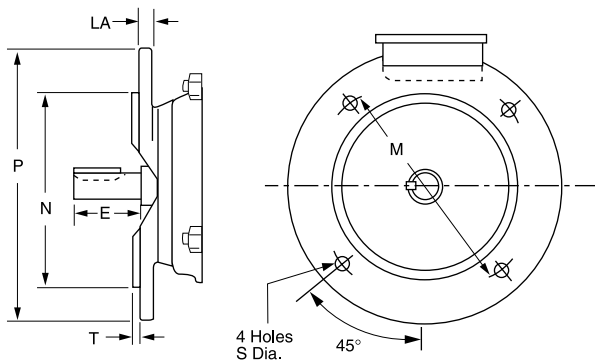

FF Flange B5 Mount

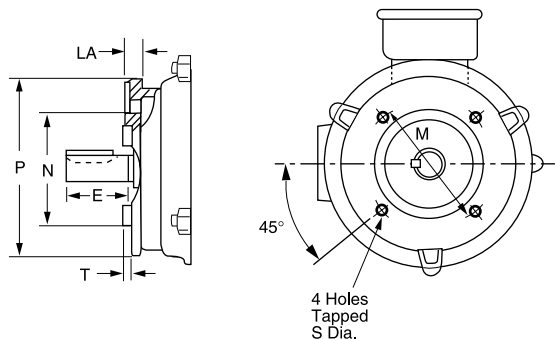

FT Face B14 Mount

# NEMA Quick Reference Dimensional Chart

Typical C-Face Motor

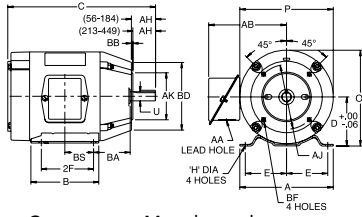

Contact your Marathon sales rep. for "AB", "O", & "P" Dim.

Typical Rigid Base Motor

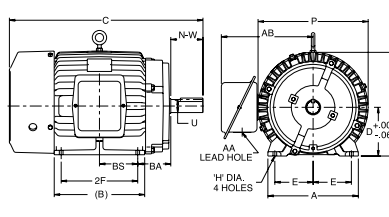

Refer to your Marathon catalog for "C" Dim.

NEMA C-Face	BA Dim.
143-5TC	2-3/4
182-4TC	3-1/2
213-5TC	4-1/4
254-6TC	4-3/4

FRAME	D	E	2F	H	U	N-W	AA	AH	AJ	AK	BA	BB (MIN)	BD (MAX)	BF
48	3.00	2.12	2.75	.34 SLOT	.5000	1.50	1/2	1.69	3.750	3.000	2.50	.13	5.62	1/4-20
56	3.50	2.44	3.00	.34 SLOT	.6250	1.88	1/2	2.06	5.875	4.500	2.75	.13	6.50	3/8-16
56H	3.50	2.44	5.00	.34 SLOT	.6250	1.88	1/2	2.06	5.875	4.500	2.75	.13	6.50	3/8-16
143T	3.50	2.75	4.00	.34	.8750	2.25	3/4	2.12	5.875	4.500	2.25	.13	6.50	3/8-16
145T	3.50	2.75	5.00	.34	.8750	2.25	3/4	2.12	5.875	4.500	2.25	.13	6.50	3/8-16
182	4.50	3.75	4.50	.41	.8750	2.25	3/4	2.12	5.875	4.500	2.75	.13	6.50	3/8-16
184	4.50	3.75	5.50	.41	.8750	2.25	3/4	2.12	5.875	4.500	2.75	.13	6.50	3/8-16
182T	4.50	3.75	4.50	.41	1.125	2.75	3/4	2.62	7.250	8.500	2.75	.25	9.00	1/2-13
184T	4.50	3.75	5.50	.41	1.125	2.75	3/4	2.62	7.250	8.500	2.75	.25	9.00	1/2-13
213	5.25	4.25	5.50	.41	1.125	3.00	1	2.75	7.250	8.500	3.50	.25	9.00	1/2-13
215	5.25	4.25	7.00	.41	1.125	3.00	1	2.75	7.250	8.500	3.50	.25	9.00	1/2-13
213T	5.25	4.25	5.50	.41	1.375	3.38	1	3.12	7.250	8.500	3.50	.25	9.00	1/2-13
215T	5.25	4.25	7.00	.41	1.375	3.38	1	3.12	7.250	8.500	3.50	.25	9.00	1/2-13
254U	6.25	5.00	8.25	.53	1.375	3.75	1-1/4	3.50	7.250	8.500	4.25	.25	10.00	1/2-13
256U	6.25	5.00	10.00	.53	1.375	3.75	1-1/4	3.50	7.250	8.500	4.25	.25	10.00	1/2-13
254T	6.25	5.00	8.25	.53	1.625	4.00	1-1/4	3.75	7.250	8.500	4.25	.25	10.00	1/2-13
256T	6.25	5.00	10.00	.53	1.625	4.00	1-1/4	3.75	7.250	8.500	4.25	.25	10.00	1/2-13
284U	7.00	5.50	9.50	.53	1.625	4.88	1-1/2	4.62	9.000	10.500	4.75	.25	11.25	1/2-13
286U	7.00	5.50	11.00	.53	1.625	4.88	1-1/2	4.62	9.000	10.500	4.75	.25	11.25	1/2-13
284T	7.00	5.50	9.50	.53	1.875	4.62	1-1/2	4.38	9.000	10.500	4.75	.25	11.25	1/2-13
286T	7.00	5.50	11.00	.53	1.875	4.62	1-1/2	4.38	9.000	10.500	4.75	.25	11.25	1/2-13
284TS	7.00	5.50	9.50	.53	1.625	3.25	1-1/2	3.00	9.000	10.500	4.75	.25	11.25	1/2-13
286TS	7.00	5.50	11.00	.53	1.625	3.25	1-1/2	3.00	9.000	10.500	4.75	.25	11.25	1/2-13
324U	8.00	6.25	10.50	.66	1.875	5.62	2	5.38	11.000	12.500	5.25	.25	14.00	5/8-11
326U	8.00	6.25	12.00	.66	1.875	5.62	2	5.38	11.000	12.500	5.25	.25	14.00	5/8-11
324T	8.00	6.25	10.50	.66	2.125	5.25	2	5.00	11.000	12.500	5.25	.25	14.00	5/8-11
326T	8.00	6.25	12.00	.66	2.125	5.25	2	5.00	11.000	12.500	5.25	.25	14.00	5/8-11
324TS	8.00	6.25	10.50	.66	1.875	3.75	2	3.50	11.000	12.500	5.25	.25	14.00	5/8-11
326TS	8.00	6.25	12.00	.66	1.875	3.75	2	3.50	11.000	12.500	5.25	.25	14.00	5/8-11
364U	9.00	7.00	11.25	.66	2.125	6.38	2-1/2	6.12	11.000	12.500	5.88	.25	14.00	5/8-11
365U	9.00	7.00	12.25	.66	2.125	6.38	2-1/2	6.12	11.000	12.500	5.88	.25	14.00	5/8-11
364T	9.00	7.00	11.25	.66	2.375	5.88	2-1/2	5.62	11.000	12.500	5.88	.25	14.00	5/8-11
365T	9.00	7.00	12.25	.66	2.375	5.88	2-1/2	5.62	11.000	12.500	5.88	.25	14.00	5/8-11
364TS	9.00	7.00	11.25	.66	1.875	3.75	2-1/2	3.50	11.000	12.500	5.88	.25	14.00	5/8-11
365TS	9.00	7.00	12.25	.66	1.875	3.75	2-1/2	3.50	11.000	12.500	5.88	.25	14.00	5/8-11
404U	10.00	8.00	12.25	.81	2.375	7.12	3	6.88	11.000	12.500	6.62	.25	15.50	5/8-11
405U	10.00	8.00	13.75	.81	2.375	7.12	3	6.88	11.000	12.500	6.62	.25	15.50	5/8-11
404T	10.00	8.00	12.25	.81	2.875	7.25	3	7.00	11.000	12.500	6.62	.25	15.50	5/8-11
405T	10.00	8.00	13.75	.81	2.875	7.25	3	7.00	11.000	12.500	6.62	.25	15.50	5/8-11
404TS	10.00	8.00	12.25	.81	2.125	4.25	3	4.00	11.000	12.500	6.62	.25	15.50	5/8-11
405TS	10.00	8.00	13.75	.81	2.125	4.25	3	4.00	11.000	12.500	6.62	.25	15.50	5/8-11
444U	11.00	9.00	14.50	.81	2.875	8.62	3	8.38	14.000	16.000	7.50	.25	18.00	5/8-11
445U	11.00	9.00	16.50	.81	2.875	8.62	3	8.38	14.000	16.000	7.50	.25	18.00	5/8-11
444T	11.00	9.00	14.50	.81	3.375	8.50	3	8.25	14.000	16.000	7.50	.25	18.00	5/8-11
445T	11.00	9.00	16.50	.81	3.375	8.50	3	8.25	14.000	16.000	7.50	.25	18.00	5/8-11
444TS	11.00	9.00	14.50	.81	2.375	4.75	3	4.50	14.000	16.000	7.50	.25	18.00	5/8-11
445TS	11.00	9.00	16.50	.81	2.375	4.75	3	4.50	14.000	16.000	7.50	.25	18.00	5/8-11
447T	11.00	9.00	20.00	.81	3.375	8.50	3	8.25	14.000	16.000	7.50	.25	18.00	5/8-11
449T	11.00	9.00	25.00	.81	3.375	8.50	3	8.25	14.000	16.000	7.50	.25	18.00	5/8-11
447TS	11.00	9.00	20.00	.81	2.375	4.75	4 NPT	4.50	14.000	16.000	7.50	.25	18.00	5/8-11
449TS	11.00	9.00	25.00	.81	2.375	4.75	4 NPT	4.50	14.000	16.000	7.50	.25	18.00	5/8-11

**marathon**<sup>®</sup>  
Motors



100 East Randolph St., P.O. Box 8003  
Wausau, WI 54402-8003  
PH: 715-675-3311

www.marathonelectric.com

A Regal Brand



www.regalbeloit.com